

**Appendix -M: Walnut Spreading Basin Improvements Supporting Documents**

(Please see Appendix CD for documents)

This page intentionally left blank.



MANAGEMENT OF THE  
**CALIFORNIA  
STATE WATER  
PROJECT**

BULLETIN 132-08 | JUNE 2012

**EDMUND G. BROWN JR.**  
*Governor, State of California*

**JOHN LAIRD**  
*Secretary for Natural Resources  
Natural Resources Agency*

**MARK W. COWIN**  
*Director, Department of Water Resources*



## Publishing Information

Cover photo shows an aerial view of Chrisman Pumping Plant.

Cover design: Xiaojun Li, Graphic Designer, Graphic Services.

Photos provided by the Public Affairs Office Photography Unit.

Copies of this document are available for \$25.00 per book and \$5.00 per CD ROM from:

Publication Sales  
Department of Water Resources  
P.O. Box 942836  
Sacramento, CA 94236-0001  
(916) 653-1097

Printed on recycled paper 

**Bulletin 132-08**

# **Management of the California State Water Project**

*Covers Activities during Calendar Year 2007*



*Published June 2012*

**Edmund G. Brown Jr.** *Governor  
State of California*

**John Laird** *Secretary for Natural Resources  
Natural Resources Agency*

**Mark W. Cowin** *Director  
Department of Water Resources*

## Foreword

**B**ulletin 132-08, Management of the California State Water Project, continues the Bulletin 132 annual series begun in 1963. Bulletin 132-08 updates water supply planning, construction, financing, management, and operation activities of the State Water Project. Appendix B contains data and computations used to determine the State Water Project water contractors' Statement of Charges for 2009. Appendix B was previously printed and distributed to State Water Project water contractors to document and support calculation of contractors' annual charges.

The Bulletin discusses significant events and issues that affect State Water Project management and operations. The Bulletin covers the period from January 1, 2007, through December 31, 2007.

Bulletin 132-08 also discusses water supply and delivery as well as Delta resources and environmental issues, including the CALFED Bay-Delta Authority; Oroville facilities relicensing; and financial analysis of the State Water Project.

Please note that the water delivery figures listed are accurate at the time of this Bulletin 132 publication, but small volumes of water may be reclassified over time pursuant to long-term water supply contract provisions. If your research requires more current data than were available at the time of publication, please consult the most recent edition of Bulletin 132 and/or contact DWR staff in the State Water Project Analysis Office.



Mark W. Cowin  
*Director*

# Contents

<b>Foreword .....</b>	<b>iii</b>
Organization and Acknowledgements.....	xxii
Departmental Divisions and Offices .....	xxiii
California Water Commission .....	xxiv
Acronyms and Abbreviations .....	xxv
State Water Project Long-term Water Supply Contractors.....	xxxii
Non-SWP Water Contractors .....	xxxiii
<b>Executive Summary .....</b>	<b>xxxv</b>
2007 SWP Highlights .....	xxxvii
David N. Kennedy: 1936–2007 .....	xxxviii
40th Anniversary of Sisk and Oroville Dams .....	xxxviii
Monterey Agreement Draft EIR and Public Meetings.....	xxxviii
Levee Evaluation and Repairs .....	xxxix
Levee Emergency Repair .....	xxxix
Aerial Levee Surveys .....	xxxix
Underwater Topographic Surveys.....	xxxix
Climate Change .....	xxxix
Yearly Activities Summary .....	xxxix
2007 Precipitation and Water Storage .....	xxxix
2007 Water Supplies, Contracts, and Deliveries.....	xl
Power Resources.....	xlii
Oroville Relicensing Settlement Agreement.....	xlii
Financial Analysis.....	xlii
Litigation.....	xlii
Delta Smelt.....	xlii

Flood Protection ..... xlv

Delta Resources and Environmental Issues..... xlv

    Environmental Water Account ..... xlv

    DWR Stops Pumping to Protect Delta Smelt ..... xlv

    Delta Vision ..... xlv

    Delta Risk Management Strategy..... xlv

    North Delta Program ..... xlv

    Watershed Grant Awards..... xlvi

    Quagga Mussel Monitoring ..... xlvi

    Status of Threatened or Endangered Species Listings..... xlvi

    Pelagic Organism Decline in the Upper San Francisco Estuary ..... xlvii

    Lake Davis Northern Pike Eradication ..... xlvii

    DWR Scientists Discover New Invertebrate Species ..... xlvii

SWP Security Measures..... xlvii

SWP Milestones through the Decades..... xlviii

    Fifty Years Ago–1957..... xlviii

    Twenty Years Ago–1987..... xlviii

    Ten Years Ago–1997..... xlviii

**Chapter 1 The State Water Project..... 1**

The State Water Project ..... 3

Precipitation and Runoff ..... 3

Water Delivery Facilities ..... 3

Project Design..... 4

Future Planning and Construction..... 7

Methods of Financing..... 10

Long-Term Contracting Agencies..... 10

**Chapter 2 Delta Resources..... 13**

Delta Water Management Programs ..... 15

    Delta Vision ..... 15



Delta Risk Management Strategy.....	17
CALFED Ecosystem Restoration Program Conservation Strategy.....	17
Bay Delta Conservation Plan.....	17
North Delta Program.....	19
West Delta Program.....	21
South Delta Improvements Program .....	21
Delta Flood Control .....	23
CALFED Levee System Integrity Program.....	25
Delta Levee Maintenance Subventions Program .....	26
Delta Levees Habitat Improvement.....	26
Delta Special Flood Control Projects Program .....	27
Reuse of Dredged Material for Delta Levees .....	28
Subsidence Investigations.....	29
Delta Agricultural Water Agencies .....	29
South Delta Water Agency Contract .....	30
Western Delta Municipal Water Users.....	30
<b>Chapter 3 Environmental Programs.....</b>	<b>31</b>
Operations for Species of Concern.....	33
San Joaquin River Activities .....	33
Environmental Water Account.....	34
Lower Yuba River Accord.....	34
Oroville Facilities Relicensing.....	35
Habitat Expansion Agreement .....	36
Invasive Species .....	36
Northern Pike Containment and Eradication, Lake Davis .....	36
Quagga Mussel Monitoring .....	37
U.S. Fish and Wildlife Service Biological Opinion.....	39
NOAA Fisheries Biological Opinion .....	39
Delta Export Curtailment.....	39
The Bay-Delta Conservation Plan.....	40

Decisions on Endangered Species..... 41

    North American Green Sturgeon ..... 41

    Delta Smelt..... 41

    Longfin Smelt ..... 41

Trends in Fish Abundance ..... 41

Feather River Fish Studies..... 44

    Rotary Screw Traps..... 44

    Acoustic and Radio Telemetry..... 45

    Salmon Escapement Survey..... 45

    Spring-run Salmon Tagging ..... 46

    Otolith Thermal Marking Studies..... 46

Pelagic Organism Decline in the Upper San Francisco Estuary..... 46

Fish-Related Mitigation Projects..... 47

**Chapter 4 Water Quality Programs..... 51**

Delta Activities ..... 53

Water Supply Conditions..... 53

    Water Year Classifications and Water Supply Indexes ..... 53

Operations under State Water Resources Control Board Water Right  
Decision 1641 ..... 55

    Delta Cross Channel Gates ..... 55

Water Quality Standards ..... 55

    Municipal and Industrial Objectives ..... 55

    Agricultural Objectives ..... 58

    Estuarine Habitat Protection Standard ..... 59

    Net Delta Outflow Index Standard ..... 59

    River Flow Standards..... 60

    Export Standards ..... 60

South Delta Temporary Barriers ..... 61

Special Study and Biological Surveys..... 61

    Fall Dissolved Oxygen Study in the Stockton Ship Channel..... 61

Benthic Survey .....	62
Phytoplankton and Chlorophyll <i>a</i> Survey .....	63
Activities Outside the Delta .....	65
Water Quality Monitoring in the SWP .....	65
Groundwater Turn-ins .....	72
Municipal Water Quality Investigations Program.....	72
Real Time Data and Forecasting Comprehensive Program .....	72
Reports .....	73
Special Studies .....	73
Bryte Chemical Laboratory .....	74
Suisun Marsh Activities.....	75
Blacklock Restoration Project .....	75
Revised Suisun Marsh Preservation Agreement .....	78
Suisun Habitat Management, Preservation, and Restoration Plan .....	79
Operation and Maintenance.....	79
Monitoring.....	80
Suisun Marsh Expenditure History.....	80
<b>Chapter 5 Local Assistance .....</b>	<b>83</b>
Davis-Grunsky Act Program .....	85
Water Use Efficiency.....	85
California Irrigation Management Information System .....	85
Recycling and Water Desalination Branch .....	86
Proposition 50 Water Use Efficiency Grant Program.....	87
Agricultural Water Management Plans.....	87
Urban Water Management Plans .....	88
Agricultural Drainage Program.....	88
Proposition 204 (Drainage Management Subaccount) .....	89
San Joaquin Valley Agricultural Drainage Program .....	89
Environmental Impact Document Review .....	100
Water Conservation Bond Laws .....	101

Propositions 25, 44, and 204 ..... 101  
 Proposition 82 ..... 101  
 Proposition 13 ..... 102  
 Proposition 50 ..... 102  
 Propositions 84 and 1E ..... 102  
 Water Conservation Bond Laws—Projects and Funding ..... 102

**Chapter 6 Legislation and Litigation .....105**

Legislation ..... 107  
     State Legislation ..... 107  
     Federal Legislation..... 107  
 Litigation ..... 107  
     Sacramento-San Joaquin Delta ..... 107  
     Hydropower..... 110  
     Colorado River ..... 112  
     Castaic Lake Water Agency ..... 113

**Chapter 7 Water Supply Development and Reliability .....117**

Supply Development and Reliability..... 119  
     Water Conveyance Through the SWP ..... 119  
     SWP Delivery Reliability Report ..... 121  
 SWP Future Water Supply Program ..... 122  
     Sacramento Valley Water Management Program ..... 122  
 SWP Water Rights Activities ..... 123  
     Water Rights Permits ..... 123  
     Water Quality Control Plan for the San Francisco Bay/  
     Sacramento-San Joaquin Delta Estuary..... 124  
     SWRCB Bay-Delta Proceedings—2007 Activities ..... 124  
 CALFED Bay-Delta Program ..... 126  
     Storage Program ..... 126

Conveyance Program.....	130
Environmental Water Account.....	131
Lower Yuba River Accord.....	132

## **Chapter 8 Water Supply.....135**

Water Year 2006–2007.....	137
Precipitation and Snowpack.....	137
Runoff and Storage.....	140
Water Year 2007–2008 October through December Water Conditions .....	141
State Water Project Storage.....	144
Water Year 2006–2007 Storage Totals .....	144
Calendar Year 2007 Storage Totals.....	144
Lake Oroville.....	144
Calendar Year 2007 Inflow and Storage.....	145
2006–2007 Water Year San Luis Reservoir Operations.....	145
2006–2007 Water Year Lake del Valle Operations.....	147
2006–2007 Water Year Southern Reservoir Operations.....	147
Diversions from the Delta.....	147

## **Chapter 9 Water Contracts and Deliveries.....151**

Amendments to Long-Term SWP Water Supply Contracts.....	153
2007 Amendments to Long-Term Water Supply Contracts .....	154
Permanent Transfers of Table A Amounts.....	155
Monterey Amendments.....	156
Miscellaneous Agreements with Long-Term SWP Water Contractors .....	156
2007 Water Conveyance and Exchange Agreements .....	156
Water Conveyance and Exchange Agreements Prior to 2007 .....	159
Turnout Agreements.....	161
Agreements and Activities Related to the Monterey Amendments .....	162
Storage of Water Outside Service Area .....	162
Article 21 Water Program .....	165

Flexible Storage Program .....	166
Extended Carryover Program .....	166
Kern River Intertie .....	167
Environmental Water Account .....	167
Technical Services for Evaluation of the Environmental Water Account .....	168
Purchased Assets .....	168
Operational Assets.....	169
Miscellaneous Agreements with Other Agencies.....	170
Water Conveyance Agreements—CVP Water.....	170
Water Deliveries .....	172
Table A Deliveries .....	172
2007 SWP Deliveries.....	172
2007 Water Deliveries to Long-Term SWP Water Contractors .....	173
Water Delivered in 2007 by Month .....	175
2007 Non-SWP Water .....	175
Annual Table A Water and Water Delivered Since 1962.....	176

## **Chapter 10 Power Resources.....193**

Power Resources Program.....	195
Major Electric Utility Industry Developments.....	195
DWR Participation in Electric Utility Industry Activities.....	195
Bulk Electric System Reliability Standards .....	197
Oroville Facilities Relicensing .....	198
Existing SWP Power Facilities .....	200
Future SWP Power Facilities.....	200
Contractual Resource Arrangements.....	200
Load Management.....	202
Contractual Transmission Agreements .....	203
SWP Power Operation in 2007.....	203
Energy Consumed.....	203

Energy Generated .....	203
Contractual Resource Arrangements.....	203
Sales of Excess Power .....	204
Forecasting Power Operations .....	204

## **Chapter 11 Facilities Maintenance .....209**

Inspecting and Maintaining Project Dams .....	211
Routine Inspections .....	211
Joint-Use Facility Inspection.....	211
Independent Reviews .....	211
Arroyo Pasajero Program.....	212
DWR and DWR/Reclamation Alternative Long-term Solution .....	213
Related Activities .....	213
Repairs and Modifications.....	214

## **Chapter 12 Engineering, Construction, and Real Estate.....217**

Design Activities.....	219
Construction Activities.....	221
Upper Feather River Division .....	221
Oroville Division .....	221
Delta Facilities.....	222
Suisun March Facilities.....	222
North Bay Aqueduct.....	223
South Bay Aqueduct .....	223
San Luis Division .....	224
South San Joaquin Division .....	225
Tehachapi Division .....	225
Mojave Division .....	225
Santa Ana Division .....	226
West Branch .....	227

Construction Activities in Multiple Divisions ..... 228  
 Miscellaneous Construction Activities..... 230  
 Real Estate Branch Activities ..... 232

**Chapter 13 Recreation .....239**

Recreation Areas ..... 241  
 Recreation Use ..... 241  
 Facilities ..... 241  
     Planning ..... 241  
     New Facilities ..... 243  
     Improvements to Facilities ..... 243  
 Oroville Recreation Plan ..... 244  
 Fish Planting ..... 244  
 SWP Deliveries for Recreation ..... 244  
 Recreation Financing ..... 244  
     Capital Cost Allocations ..... 246  
     Accrued Interest Charges ..... 246

**Chapter 14 Financial Analysis .....249**

Capital Requirements and Financing ..... 251  
     Capital Requirements ..... 252  
     Capital Financing ..... 256  
     Capital Financing Sources ..... 258  
 Annual Revenues and Expenditures ..... 260  
     Project Revenues..... 260  
     Project Expenses ..... 267  
 Future Costs of Water Service..... 269

**Chapter 15 SWP Education and Information .....275**

News Topic Highlights..... 277



Snow Surveys.....	277
Drought Conditions.....	277
Delta Pumping.....	277
Flood Protection.....	278
Climate Change Activities .....	278
Death of David N. Kennedy .....	278
News Events.....	278
Community Relations.....	279
2007 California State Fair .....	279
SWP Publications .....	280
Community Outreach.....	280
SWP Visitors Centers .....	280
School Education Program.....	280

## Tables

<b>Table ES-1</b>	SWP Water Delivered by Category, 1962–2007 .....	xli
<b>Table 1-1</b>	Physical Characteristics of Primary Storage Facilities.....	7
<b>Table 1-2</b>	Physical Characteristics of Primary Dams .....	8
<b>Table 1-3</b>	Pumping Plant Characteristics .....	8
<b>Table 1-4</b>	Power Plant Characteristics, by Type and Facility .....	9
<b>Table 1-5</b>	Total Miles of Aqueducts .....	9
<b>Table 1-6</b>	Long-Term Water Supply Contracting Agencies, by Area, as of December 31, 2007 .....	12
<b>Table 3-1</b>	Delta Fish Agreement Mitigation Projects Funded, Approved, or Implemented.....	49
<b>Table 4-1</b>	O&M SWP Automated Water Quality Monitoring Stations and Test Parameters .....	65
<b>Table 4-2</b>	O&M SWP Water Quality Grab Sample Locations .....	66
<b>Table 4-3</b>	O&M SWP Grab Sampling Schedule.....	67
<b>Table 4-4</b>	Mean Water Quality at Selected SWP Grab Sample Locations, 2007 .....	70
<b>Table 4-5</b>	Pesticides, Herbicides, and Other Organic Substances Detected in the SWP, 2007 .....	71
<b>Table 4-6</b>	Suisun Marsh Expenditures and Reimbursements Administered by DWR.....	81
<b>Table 5-1</b>	Cumulative Water Conservation Bond Laws—Projects and Funding through 2007 .....	103
<b>Table 8-1</b>	Monthly Precipitation Totals at Various Locations in California during Water Year 2006–2007 .....	139
<b>Table 8-2</b>	Northern Sierra 8-Station Precipitation for Water Year 2006–2007 .....	139
<b>Table 8-3</b>	Statewide Snowpack for Water Year 2006–2007 .....	140
<b>Table 8-4</b>	Unimpaired Runoff for Water Year 2006–2007 .....	140
<b>Table 8-5</b>	Reservoir Storage for Water Year 2006–2007 .....	141
<b>Table 9-1</b>	2007 Turn-Back Water Pool Program.....	162

## Tables, continued

<b>Table 9-2</b>	2007 Article 21 Water Deliveries .....	166
<b>Table 9-3</b>	Water Delivered to Long-Term Contractors in 2007, by Service Area .....	178
<b>Table 9-4</b>	Total Amounts of Water Delivered in 2007, by Month .....	179
<b>Table 9-5</b>	Total Amounts of Annual Table A Water and Water Conveyed, by Type, 1962–2007 .....	191
<b>Table 10-1</b>	Energy Used at Pumping Plants and Power Plants in 2007, by Month .....	206
<b>Table 10-2</b>	Energy Generated and Purchased in 2007, by Month .....	207
<b>Table 10-3</b>	Power, Transmission, and Related Purchases in 2007, by Service Area .....	208
<b>Table 10-4</b>	Energy Sold in 2007 and Revenue from Sales, by Service Area .....	208
<b>Table 11-1</b>	Outages for Maintenance and Repair of Facilities in 2007, by Month .....	215
<b>Table 12-1</b>	Design Activities, January 1, 2007, through December 31, 2007, by Division .....	233
<b>Table 12-2</b>	Construction Activities, January 1, 2007, through December 31, 2007, by Division .....	235
<b>Table 13-1</b>	Recreation Days Estimated in 2007, by Field Division and Facility .....	243
<b>Table 13-2</b>	Fish Planted by Department of Fish and Game in 2007 .....	245
<b>Table 13-3</b>	Recreation and Enhancement Costs of the State Water Project .....	247
<b>Table 13-4</b>	Calculation of Interest Accruals on California Water Resources Development Bond Fund Disbursements .....	248
<b>Table 14-1</b>	Capital Requirements and Financing, December 31, 2007 .....	271
<b>Table 14-2</b>	State Water Project Revenues and Expenditures, December 31, 2007 .....	272
<b>Table 14-3</b>	Allocation of Capital Expenditures .....	253
<b>Table 14-4</b>	East Branch Enlargement Capital Costs by Facility .....	255

## Tables, continued

<b>Table 14-5</b>	Estimated Capital Costs for Power Generation and Transmission Facilities .....	255
<b>Table 14-6</b>	Estimated Future Costs for Planning Additional Conservation Facilities .....	255
<b>Table 14-7</b>	Application of Revenue Bond Proceeds.....	257
<b>Table 14-8</b>	Revenue Bond Proceeds Affecting Project Interest Rate.....	263
<b>Table 14-9</b>	Actual Bond Sales and Project Interest Rates, by Date of Sale .....	264
<b>Table 14-10</b>	Operations, Maintenance, Power, and Replacement Costs, by Facility, Composition, and Purpose .....	273
<b>Table 14-11</b>	Annual Debt Service on Bonds Sold through December 31, 2007 .....	274
<b>Table 14-12</b>	Estimated Unit Water Charges for 2009 and 2014, by Service Area .....	269

## Figures

<b>Figure 1-1</b>	Names and Locations of Primary Water Delivery Facilities, December 31, 2007 .....	5
<b>Figure 1-2</b>	Names, Locations, and First Year of Service of Long-Term Contracting Agencies, December 31, 2007.....	11
<b>Figure 2-1</b>	The North, West, and South Delta as Defined in Public Resources Code Section 29735 .....	16
<b>Figure 2-2</b>	North Delta Flood Control and Ecosystem Restoration Project, Project Area .....	20
<b>Figure 2-3</b>	Temporary Barrier Locations.....	24
<b>Figure 3-1</b>	Longfin Smelt Fall Midwater Trawl Abundance Index, 1967–2007 .....	42
<b>Figure 3-2</b>	Delta Smelt Fall Midwater Trawl Abundance Index, 1967–2007 .....	42
<b>Figure 3-3</b>	Estimated Total Adult Winter-Run Chinook Salmon Escapement, 1967–2007 .....	43
<b>Figure 3-4</b>	Estimated Spring-Run Chinook Salmon Escapement, 1990–2007 .....	43
<b>Figure 4-1</b>	Decision 1641 Water Quality Compliance and Monitoring Stations in the Sacramento-San Joaquin Delta .....	54
<b>Figure 4-2</b>	Compliance and Monitoring Stations and Water Management Facilities in the Suisun Bay and Marsh .....	76
<b>Figure 5-1</b>	San Joaquin River Input-Output Day Modeling Forecast Example.....	96
<b>Figure 7-1</b>	SWP Table A Water Delivery Probability for Years 2007 and 2027 .....	122
<b>Figure 8-1</b>	Statewide Precipitation by Hydrologic Region, 2006–2007 Water Year, as Percent of Average .....	138
<b>Figure 8-2</b>	Monthly Inflow into Lake Oroville from the Feather River, 2005–2007 Calendar Years .....	145
<b>Figure 8-3</b>	Cumulative Maximum, Minimum, and Current Lake Oroville Inflow.....	146
<b>Figure 8-4</b>	End-of-Month Storage in Lake Oroville, 2006 and 2007 Calendar Years .....	146

## Figures, continued

<b>Figure 8-5</b>	End-of-Month Storage in San Luis Reservoir, 2006 and 2007 Calendar Years .....	147
<b>Figure 8-6</b>	Water Pumped at Banks Pumping Plant, 2007 Calendar Year .....	148
<b>Figure 8-7</b>	Sacramento-San Joaquin Delta Exports by State Water Project and Central Valley Project, 2007 Calendar Year.....	149
<b>Figure 8-8</b>	Water Pumped at Dos Amigos Pumping Plant, 2007 Calendar Year .....	149
<b>Figure 8-9</b>	Water Pumped at Edmonston Pumping Plant, 2007 Calendar Year .....	150
<b>Figure 9-1</b>	Water Delivered in 2007 and Delivery Locations of Long-Term Water Supply Contractors and Feather River Area Districts with Water Rights Agreements with DWR .....	174
<b>Figure 10-1</b>	Names, Locations, and Nameplate Capacities of Primary Power Facilities .....	201
<b>Figure 13-1</b>	Names and Locations of SWP Recreation Areas .....	242
<b>Figure 15-1</b>	Visitors Centers on the SWP .....	281

## Sidebars

State Water Project Power Generation and Consumption in 2007 .....	xliii
2007 Income Statement for the State Water Project .....	xliii
Bay Delta Conservation Plan Proposed Conservation Strategy Options .....	18
Endangered Species Acts.....	40
State Water Resources Control Board .....	56
Habitat Management, Preservation, and Restoration Plan for the Suisun Marsh (Suisun Marsh Plan).....	77
Environmental Review Acts.....	115
CALFED Bay-Delta Program .....	127
Precipitation and Water Supply Indices .....	142
SWP Long-Term Water Supply Contracts.....	154

<b>Appendix A</b>	Annual Financial Report (discontinued)
<b>Appendix B</b>	Data and Computations Used to Determine 2009 Water Charges (included in this bulletin)
<b>Appendix C</b>	The California State Water Project Summary (discontinued)
<b>Appendix D</b>	Costs of Recreation and Fish and Wildlife Enhancement (discontinued)
<b>Appendix E</b>	Water Operations in the Sacramento-San Joaquin Delta (discontinued)
<b>Appendix F</b>	San Joaquin Valley Post-Project Economic Impact (discontinued)

**State of California**

Edmund G. Brown Jr., Governor

**California Natural Resources Agency**

John Laird, Secretary for Natural Resources

**Department of Water Resources**

Mark W. Cowin, Director

Sue Sims, Chief Deputy Director

Cathy Crothers, Chief Counsel

Kasey D. Schimke, Assistant Director, Legislative Affairs

Nancy Vogel, Assistant Director, Public Affairs

Gary Bardini, Deputy Director

Dale K. Hoffman-Floerke, Deputy Director

Katherine S. Kishaba, Deputy Director

John Andrew, Assistant Deputy Director

John Pacheco, Acting Deputy Director

Carl A. Torgersen, Deputy Director

Mark E. Andersen, Assistant Deputy Director

This report was prepared under the direction of

**State Water Project Analysis Office**

Robert B. Cooke, Chief

Scott Jercich, Principal Engineer

Craig Trombly, Principal Engineer

Pedro Villalobos, Principal Engineer

By

Lori C. Brown, Senior Engineer

Deborah McEwan, Research Writer

Therese J. Tynan, Research Writer

Lorna K. Wilson, Research Writer

With major contributions provided under the direction of

Teodoro Alvarez, Chief, Oroville Facilities Relicensing Branch

Jeremiah McNeil, Chief, SWP Program Coordination

Geoff Shaw, Chief, Water Contracts Branch

Mike Cunnagin, Fiscal Coordinator

Paul Mendoza, Chief, Water Delivery Analysis and Documentation Branch

Dave Paulson, Chief, Project Cost Branch

Nancy Quan, Chief, Program Development and Water Supply and Transfers Branch

Shahram Ahi, Senior Engineer

Nova Clemenza, Senior Engineer

Andrea Glasgow, Senior Engineer

Lincoln King, Senior Engineer

Susan Lee, Senior Engineer

Julie Myers, Senior Engineer

Amir Rangchi, Senior Engineer

Bhupinder Sandhu, Senior Engineer

Maureen Sergent, Senior Engineer

Kevin Sun, Senior Engineer

Alice Tay, Senior Engineer

Kuen Tsay, Senior Engineer

Jim Upholt, Senior Engineer

Bill Voss, Senior Engineer

Kathleen Wright, Senior Engineer

Reza Zamanian, Senior Engineer



## Departmental Divisions and Offices

Bulletin 132 also relies on these DWR divisions and offices for information, financial and cost accounting data, and content review.

### **Bay-Delta Office**

Katherine F. Kelly, Chief

Joel Ledesma, Chief, Delta  
Field Division

Jim Thomas, Chief, San Luis  
Field Division

Jeff J. Said, Chief, San Joaquin  
Field Division

John R. Bunce, Chief, Southern  
Field Division

### **Division of Engineering**

Rich Sanchez, Chief

### **Division of Environmental Services**

Dean Messer, Chief

### **Division of Statewide Integrated Water Management**

Kamyar Guivetchi, Chief

### **Division of Fiscal Services**

Perla Netto-Brown, Chief

### **Division of Safety of Dams**

David A. Gutierrez, Chief

### **Division of Flood Management**

Keith Swanson, Chief

### **FloodSAFE Environmental Stewardship and Statewide Resources Office**

Gail Newton, Chief

### **Division of Integrated Regional Water Management**

Paula J. Landis, Chief

Curtis Anderson, Chief, Northern  
Region Office

Eric Hong, Chief, North Central  
Region Office

Kevin Faulkenberry, Chief, South  
Central Region Office

Mark Stuart, Chief, Southern  
Region Office

### **Legislative Affairs Office**

Kasey D. Schimke, Assistant Director

### **Office of the Chief Counsel**

Cathy Crothers, Chief Counsel

### **Division of Operations and Maintenance**

David Starks, Chief

Peter Scheele, Chief, Oroville  
Field Division

### **Public Affairs Office**

Nancy Vogel, Assistant Director

### **SWP Power and Risk Office**

Veronica G. Hicks, Chief

## California Water Commission

The California Water Commission consists of nine members appointed by the Governor and confirmed by the Senate. Seven members are chosen for their expertise related to the control, storage, and beneficial use of water and two are chosen for their knowledge of the environment. The commission advises the Director of the Department of Water Resources (DWR) on matters within DWR's jurisdiction, approves rules and regulations, and monitors and reports on the construction and operation of the State Water Project (SWP).

The roles and responsibilities of the California Water Commission are defined in the Water Code, Government Code, and Code of Civil Procedure.

Its SWP-specific responsibilities are:

- conducting an annual review of the construction and operation of the SWP and reporting to DWR and to the Legislature with any recommendations (Water Code Section 165);
- holding public hearings on all additional facilities proposed to be added to the SWP and naming any new facilities (Water Code Sections 161.5 and 166); and
- adopting a resolution of necessity, and giving each affected person a venue to be heard, before DWR may commence an eminent domain proceeding (Code of Civil Procedure Section 1245.210).

Commission members at the time of publication:

Anthony Saracino (Chair)

Andrew Ball

Joseph Byrne

Daniel Curtin

Joe Del Bosque

Kimberley Delfino

Luther Hintz

# Acronyms and Abbreviations

## *Symbols*

**2,4-D** 2,4-dichlorophenoxyacetic acid

**µg/L** micrograms per liter

**µm** micrometer

**µS/cm** microsiemens per centimeter

## *A*

**AB** Assembly Bill

**ACWA** Association of California Water Agencies

**ADA** Americans with Disabilities Act

**af** acre-feet/acre-foot

**Ag Council** Agricultural Water Management Council

**ALP** Alternative Licensing Process

## *B*

**Bay-Delta Accord** Principles for Agreement on Bay-Delta Standards between the State of California and the Federal Government

**Bay-Delta Estuary** San Francisco Bay/Sacramento-San Joaquin Delta Estuary

**Bay-Delta Plan** Water Quality Control Plan for the San Francisco Bay/Sacramento-San Joaquin Delta Estuary

**BCDC** Bay Conservation and Development Commission

**BDCP** Bay Delta Conservation Plan

**BMPs** Best Management Practices

**BO** biological opinion

## *C*

**CAISO** California Independent System Operator

**CALFED** CALFED Bay-Delta Program

**Caltrans** California Department of Transportation

**CAMAL Net** California Association of Mutual Aid Laboratories Network

**C.A.S.T.** Catch A Special Thrill

**CBDA** California Bay-Delta Authority

**CDEC** California Data Exchange Center

**CDFA** California Department of Food and Agriculture

**CDO** Cease and Desist Order

**CEC** California Energy Commission

**CEEIN** California Environmental Education Interagency Network

**CEQA** California Environmental Quality Act

**CESA** California Endangered Species Act  
**CFR** Comprehensive Facility Review  
**cfs** cubic feet per second  
**CIMIS** California Irrigation Management Information System  
**CO<sub>2</sub>** carbon dioxide  
**Corps** U.S. Army Corps of Engineers  
**CPUC** California Public Utilities Commission  
**CRA** Colorado River Aqueduct  
**CREEC** California Regional Environmental Education Community  
**CST** Combined Solar Technologies  
**CUSE** Catholic University of Santiago del Estero  
**CVC** Cross Valley Canal  
**CVFPB** Central Valley Flood Protection Board  
**CVFPP** Central Valley Flood Protection Plan  
**CVP** Central Valley Project  
**CVPIA** Central Valley Project Improvement Act  
**CVRWQCB** Central Valley Regional Water Quality Control Board  
**CV-SALTS** Central Valley Salinity Alternatives for Long-Term Sustainability  
**CWC** California Water Code  
**CWIN** California Water Impact Network

**D**

**D-1485** State Water Resources Control Board, Water Right Decision 1485  
**D-1641** State Water Resources Control Board, Water Right Decision 1641  
**DBEEP** Delta-Bay Enhanced Enforcement Program  
**DBW** Department of Boating and Waterways  
**DCC** Delta Cross Channel  
**DCPA** dimethyl tetrachloroterephthalate or dacthal  
**DDA** Davis-Dolwig Act  
**Delta Fish Agreement** Delta Pumping Plant Fish Protection Agreement  
**DFG** Department of Fish and Game  
**DIRWM** Division of Integrated Regional Water Management  
**DMMs** demand management measures  
**DO** dissolved oxygen  
**DOE** Division of Engineering  
**DPH** Department of Public Health  
**DPR** Department of Parks and Recreation  
**DPS** distinct population segment  
**DRMS** Delta Risk Management Strategy  
**DSIWM** Division of Statewide Integrated Water Management  
**DSM2** Delta Simulation Model 2  
**DSOD** Division of Safety of Dams  
**DSWG** Delta Smelt Working Group  
**DW** drainage water  
**DWR** Department of Water Resources

**E**

**EC** electrical conductivity  
**EIR** environmental impact report  
**EIS** environmental impact statement  
**ELAP** DPH Environmental Laboratory Accreditation Program  
**EPA** U.S. Environmental Protection Agency  
**ERO** Electric Reliability Organization  
**ERP** CALFED Ecosystem Restoration Program  
**ESA** Endangered Species Act  
**ET<sub>o</sub>** reference evapotranspiration  
**EWA** Environmental Water Account  
**EWMPs** Efficient Water Management Practices

**F**

**FAAST** Financial Assistance Application Submittal Tool  
**Farm Bureau** California Farm Bureau Federation  
**FERC** Federal Energy Regulatory Commission  
**FGC** California Fish and Game Commission  
**Fishery Plan** Revised Fishery Protection Plan  
**FRFH** Feather River Fish Hatchery  
**FWS** Future Water Supply

**G**

**GBP** Grassland Bypass Project  
**GHG** greenhouse gas  
**GIS** geographic information system  
**GOES** Geostationary Operational Environmental Satellite  
**gpm** gallons per minute  
**GPS** global positioning system

**H**

**HEA** Habitat Expansion Agreement  
**HECA** Habitat Expansion Coordination Agreement  
**HFC** high-flow channel  
**hp** horsepower

**I**

**ICS** Incident Command System  
**IDM** Integrated Drainage Management  
**IEP** Interagency Ecological Program  
**IFDM** Integrated On-Farm and Regional Drainage Management system  
**IR** Interim Renewal  
**IRRP** Interim Reliability Requirement Program

**IRWM** Integrated Regional Water Management  
**ISDP** Interim South Delta Program

**J**

**JPOD** Joint Point of Diversion

**K**

**kV** kilovolt(s)  
**KWB** Kern Water Bank  
**kWh** kilowatt hour

**L**

**LADWP** Los Angeles Department of Water and Power  
**LEAPS** Lake Elsinore Advance Pump Storage  
**LFC** low-flow channel  
**LiDAR** light detection and ranging  
**LSIP** Levee System Integrity Program  
**LSJR** Lower San Joaquin River  
**LTMS** Long-Term Management Strategy  
**LTPP** Long-Term Procurement Plan

**M**

**maf** million acre-feet  
**mg/L** milligrams per liter  
**MIDS** Morrow Island Distribution System  
**mmhos/cm** millimhos per centimeter  
**MOU** memorandum of understanding  
**MRTU** Market Redesign and Technology Upgrade  
**mS/cm** millisiemens per centimeter  
**MW** megawatt  
**MWh** megawatt hour  
**MWQI** Municipal Water Quality Investigations

**N**

**NAESB** North American Energy Standards Board  
**NDFCERP** North Delta Flood Control and Ecosystem Restoration Project  
**NDOI** Net Delta Outflow Index  
**NEMDC** Natomas East Main Drainage Canal  
**NEPA** National Environmental Policy Act  
**NERC** North American Electric Reliability Corporation  
**NOAA** National Oceanic and Atmospheric Administration  
**NOAA Fisheries** National Marine Fisheries Service  
**NODOS** North-of-the-Delta Offstream Storage

**NPC** Nevada Power Company  
**NWS** National Weather Service

## O

**OCAP** Operations Criteria and Plan  
**O&M** Division of Operations and Maintenance  
**OMP&R** operations, maintenance, power, and replacement  
**OM&R** operations, maintenance, and replacement  
**OTM** otolith thermal marking  
**OWUET** Office of Water Use Efficiency and Transfers

## P

**PAO** Public Affairs Office  
**PCL** Planning and Conservation League  
**PFMA** Potential Failure Mode Analysis  
**PFR** Periodic Facility Review  
**PG&E** Pacific Gas & Electric Company  
**PL** Public Law  
**PLC** programmable logic controller  
**POD** pelagic organism decline or point of delivery  
**Proposition 1E** Disaster Preparedness and Flood Protection Bond Act of 2006  
**Proposition 13** Safe Drinking Water, Clean Water, Watershed Protection and Flood Protection Act of 2000 Safe Drinking Water, Clean Water, Watershed Protection and Flood Protection Bond Act of 2000  
**Proposition 25** Clean Water Bond Law of 1984  
**Proposition 44** Water Conservation and Water Quality Bond Law of 1986  
**Proposition 50** Water Security, Clean Drinking Water, Coastal and Beach Protection Act of 2002  
**Proposition 82** Water Conservation Bond Law of 1988  
**Proposition 84** Safe Drinking Water, Water Quality and Supply, Flood Control, River and Coastal Protection Bond Act of 2006  
**Proposition 204** Safe, Clean, Reliable Water Supply Act of 1996  
**PSP** project solicitation package

## Q

**QA/QC** quality assurance/quality control  
**QSA** Quantification Settlement Agreement

## R

**RA** Resource Adequacy  
**RCRC** Regional Council of Rural Counties  
**Reclamation** Bureau of Reclamation  
**R&FWE** SWP Recreation and Fish and Wildlife Enhancement  
**RM** river mile

**RO** reverse osmosis  
**ROD** record of decision  
**RRR** Red Rock Ranch  
**RST** rotary screw trap  
**RTDF-CP** Real Time Data and Forecasting Comprehensive Program  
**RTWQMP** Real-time Water Quality Monitoring Program  
**RWQCB** Regional Water Quality Control Board

**S**

**SA** Settlement Agreement  
**Sacramento Valley 40-30-30 Index** Sacramento Valley Water Year Hydrologic Classification  
**SAIC** Science Applications International Corporation  
**San Joaquin Valley 60-20-20 Index** San Joaquin Valley Water Year Hydrologic Classification  
**SARMP** Settlement Agreement Recreation Management Plan  
**SB** Senate Bill  
**SB 34** Delta Flood Protection Act of 1988  
**SBA** South Bay Aqueduct  
**SCE** Southern California Edison  
**SDG&E** San Diego Gas & Electric Company  
**SDIP** South Delta Improvements Program  
**SDWA** South Delta Water Agency  
**SJRGA** San Joaquin River Group Authority  
**SJRIODAY** San Joaquin River Input-Output Day  
**SJRMP** San Joaquin River Management Program  
**SJRRP** San Joaquin River Restoration Program  
**SJRWQMG** San Joaquin River Water Quality Management Group  
**SJDIP** San Joaquin Valley Drainage Implementation Program  
**SLDFR** San Luis Drainage Feature ReEvaluation  
**SMP** Suisun Marsh Plan  
**SMPA** Suisun Marsh Preservation Agreement  
**SMUD** Sacramento Municipal Utility District  
**SRCD** Suisun Resource Conservation District  
**STID** Supporting Technical Information Document  
**SVWMA** Sacramento Valley Water Management Agreement  
**SVWMP** Sacramento Valley Water Management Program  
**SWC** State Water Contractors  
**SWP** State Water Project  
**SWPAO** State Water Project Analysis Office  
**SWRCB** State Water Resources Control Board

**T**

**TAO** Thermalito Afterbay Outlet  
**TDF** through-Delta facility  
**TDS** total dissolved solids



**THM** trihalomethane  
**TOC** total organic carbon  
**TRC** technical review committee

## U

**UC** University of California  
**UCD** University of California, Davis  
**UCLA** University of California, Los Angeles  
**Urban Council** California Urban Water Conservation Council  
**USDA** U.S. Department of Agriculture  
**USFWS** U.S. Fish and Wildlife Service  
**USGS** U.S. Geological Survey  
**USJRBSI** Upper San Joaquin River Basin Storage Investigation  
**UWMP** Urban Water Management Plan

## V

**VAMP** Vernalis Adaptive Management Plan  
**VFD** variable frequency drive

## W

**WECC** Western Electricity Coordinating Council  
**WET** Water Education for Teachers  
**WQCP** Water Quality Control Plan  
**WRAC** Water Recycling Advisory Committee  
**WRCD** Westside Resource Conservation District  
**WSREC** West Side Research and Extension Center

## Y

**Yuba Accord** Lower Yuba River Accord

## Z

**ZLD** zero liquid discharge

## State Water Project Long-term Water Supply Contractors

The State Water Project long-term water supply contractors are listed below, followed by shortened forms of their names that are used in Bulletin 132.

Alameda County Flood Control and Water Conservation District, Zone 7	Alameda-Zone 7
Alameda County Water District	Alameda County
Antelope Valley-East Kern Water Agency	AVEK
Castaic Lake Water Agency	Castaic Lake
City of Yuba City	Yuba City
Coachella Valley Water District	Coachella
County of Butte	Butte
County of Kings	Kings
Crestline-Lake Arrowhead Water Agency	Crestline
Desert Water Agency	Desert
Dudley Ridge Water District	Dudley Ridge
Empire-West Side Irrigation District	Empire
Kern County Water Agency	Kern
Littlerock Creek Irrigation District	Littlerock
Metropolitan Water District of Southern California	Metropolitan
Mojave Water Agency	Mojave
Napa County Flood Control and Water Conservation District	Napa
Oak Flat Water District	Oak Flat
Palmdale Water District	Palmdale
Plumas County Flood Control and Water Conservation District	Plumas
San Bernardino Valley Municipal Water District	San Bernardino
San Gabriel Valley Municipal Water District	San Gabriel
San Geronio Pass Water Agency	San Geronio
San Luis Obispo County Flood Control and Water Conservation District	San Luis Obispo
Santa Barbara County Flood Control and Water Conservation District	Santa Barbara
Santa Clara Valley Water District	Santa Clara
Solano County Water Agency	Solano
Tulare Lake Basin Water Storage District	Tulare
Ventura County Watershed Protection District	Ventura

## Non-SWP Water Contractors

The non-SWP water contractors are listed below, followed by shortened forms of their names that are used in Bulletin 132.

Arvin-Edison Water Storage District	Arvin-Edison
Belridge Water Storage District	Belridge
Berrenda Mesa Water District	Berrenda Mesa
Buena Vista Water Storage District	Buena Vista
Byron-Bethany Irrigation District	Byron-Bethany
Cawelo Water District	Cawelo
City of Tracy	Tracy
Contra Costa Water District	Contra Costa
County of Tulare	Tulare
Del Puerto Water District	Del Puerto
East Contra Costa Irrigation District	East Contra Costa
Fresno County Public Works	Fresno
Hills Valley Irrigation District	Hills Valley
Kern Delta Water District	Kern Delta
Kern-Tulare Water District	Kern-Tulare
Lost Hills Water District	Lost Hills
Lower Tule River Irrigation District	Lower Tule
Merced Irrigation District	Merced
Pixley Irrigation District	Pixley
Placer County Water Agency	Placer
Rag Gulch Water District	Rag Gulch
Rosedale-Rio Bravo Water Storage District	Rosedale-Rio
San Luis & Delta-Mendota Water Authority	San Luis & Delta-Mendota
Semitropic Water Storage District	Semitropic
South Feather Water and Power Agency	South Feather
Tejon-Castac Water District	Tejon-Castac
Tranquility Irrigation District	Tranquility
Tri-Valley Water District	Tri-Valley
United Water Conservation District	United
West Kern Water District	West Kern
Western Hills Water District	Western Hills
Westlands Water District	Westlands
Westside Mutual Water Company	Westside
Wheeler Ridge-Maricopa Water Storage District	Wheeler Ridge-Maricopa
Yuba County Water Agency	Yuba



## Executive Summary

*David N. Kennedy, DWR's sixth director, served in that capacity longer than any other director.*



The annual Bulletin 132 series began in 1963 and reported the first deliveries of water by the new State Water Project (SWP). Bulletin 132-08, *Management of the California State Water Project*, continues this series as the forty-sixth edition. It reports on SWP planning, construction, finance, management, and operations during calendar year 2007. The SWP is operated and maintained by the California Department of Water Resources (DWR).

Please note that all figures, such as water delivery data, are accurate at the time of this publication; however, occasional changes do occur. For example, small volumes of water may be reclassified over time pursuant to long-term water supply contract provisions. If your research requires more current data than was available at the time of publication, please consult the most recent edition of Bulletin 132 and/or contact the DWR staff in the State Water Project Analysis Office.

## 2007 SWP Highlights

The State Water Project (SWP) is one of the world's largest water, power, and conveyance systems. In the past decade it has conveyed an annual average of 2.9 million acre-feet (maf). SWP facilities—pumping and power plants; reservoirs, lakes, and storage tanks; canals, tunnels, and pipelines—capture, store, and convey water to 29 public water agencies.

California experienced lower-than-average rainfall and mountain snowpack during water year 2006–2007 (October 2006 through September 2007). Statewide precipitation was 65 percent of average, in stark contrast to the prior year's 136 percent. The Sacramento Valley Water Year Hydrologic Classification (Sacramento Valley 40-30-30 Index) and the San Joaquin Valley Water Year Hydrologic Classification (San Joaquin Valley 60-20-20 Index) were dry and critical, respectively, based on observed data for water year 2006–2007. The Northern Sierra Eight Station Index finished with 37.3 inches of precipitation, or 75 percent of average.

Water storage in all SWP reservoirs at the end of water year 2006–2007 was 2.72 maf, or 50 percent of maximum storage. Total water storage in major SWP reservoirs at

the end of calendar year 2007 was about 2.45 maf, as compared with 4.49 maf in 2006. For more information see Chapter 8, Water Supply.

In 2007, SWP deliveries totaled 4,061,696 acre-feet (af). Water was delivered to 27 of the 29 long-term water contractors and 26 other agencies. Table A deliveries totaled 2,081,217 af, of which 94,762 af was 2006 carryover. For more information see Chapter 9, Water Contracts and Deliveries.

DWR continued to be its own energy scheduling coordinator with the California Independent System Operator (CAISO), and to schedule the purchase and sale of energy to operate the SWP. In 2007, energy used at the 28 SWP pumping and generating plants totaled 9.77 million megawatt hours (MWh). DWR sold 2.26 million MWh to 20 utilities and 22 power marketers, for total revenues of \$138.89 million in 2007. For further information see Chapter 10, Power Resources.

SWP facilities supported an estimated 4.7 million recreation days during the year. Large increases over 2006 occurred at Lake del Valle, Silverwood Lake and Castaic Lake, while Lake Perris visits were down, in part because of lowered lake levels

due to seismic concerns with Perris Dam. For further recreation information, see Chapter 13, Recreation.

The project continued to pay bondholders as scheduled and remained financially viable. The long-term water contractors continued to repay project construction bonds and operating expenses. In 2007, the SWP handled approximately \$1,022 million each in revenues and expenses. For more information, see Chapter 14, Financial Analysis.

## David N. Kennedy: 1936–2007

On December 23, 2007, former DWR Director David N. Kennedy passed away at age 71. He was DWR's sixth director, serving from 1983 to 1998. Earlier in his career, he worked for DWR as an engineer from 1962 to 1968.

Under Director Kennedy, DWR expanded the SWP's Delta pumping capacity, enhanced the system's environmental safeguards, intensified Delta ecosystem and fish research, and completed construction of the 100-mile Coastal Branch to provide a supplemental water supply to users in Santa Barbara and San Luis Obispo counties. In 1994, he helped negotiate the historic Monterey Agreement.

Director Kennedy led DWR during the longest major statewide drought in modern California history, between 1987 and 1992. Drought responses included operating an innovative State Emergency Water Bank and many adaptive water supply adjustments and transfers.

Mr. Kennedy also led DWR during major flood events in 1986, 1995 and 1997—events he considered among the most challenging of his career. After widespread flooding in 1986, he helped upgrade DWR's flood-fighting abilities through creation of a Joint Operations Center.

Other achievements of the Kennedy era included the 1986 start of enlarging the SWP East Branch, adding four pumps to the Banks Pumping Plant in the 1990s, and completion of the North Bay Aqueduct Phase Two. Few individuals have had as much impact on the management of California's water supply and infrastructure as David Kennedy.

## 40th Anniversary of Sisk and Oroville Dams

During 2007, SWP recorded the 40th anniversary of two key elements—completion of Sisk Dam at San Luis Reservoir and Oroville Dam. Both dams were completed in 1967. Oroville Dam construction began in 1961. Lake Oroville is the second largest reservoir in California. Construction of Sisk Dam began in 1963. San Luis Reservoir is the largest off-stream storage reservoir in the United States.

## Monterey Agreement Draft EIR and Public Meetings

The Monterey Amendment, based on Principles of Agreement released in 1994, was designed to increase the reliability of existing water supplies, provide stronger SWP financial management, and increase water management flexibility by providing more tools for local water agencies. In accordance with terms of the 2003 Monterey Settlement Agreement, the SWP operated pursuant to the Monterey Amendment while the new EIR was being prepared.

In October 2007, DWR released the *Draft Environmental Impact Report* (EIR) for the Monterey Amendment to SWP Contracts, including the Kern Water Bank Transfer and associated actions as part of a Settlement Agreement (Monterey Plus).

The draft EIR addressed the environmental impacts of changes to the SWP operations that are a consequence of the Monterey

Amendment and the Settlement Agreement. It also discussed the project alternatives, growth inducement, water supply reliability, as well as potential areas of controversy and concern. Four public meetings were held across the State to solicit public comments on the draft EIR.

## Levee Evaluation and Repairs

### Levee Emergency Repair

In January 2007, DWR completed work on 19 of the 71 emergency levee repair sites identified the year before—12 on the Sacramento River and seven on the lower San Joaquin River.

### Aerial Levee Surveys

In spring, DWR aerially surveyed 350 miles of urban levees as part of the Levee Evaluation Program. The helicopter-borne equipment collected GPS, laser scanner and digital imagery data for use in geotechnical and erosion studies of the targeted levees.

### Underwater Topographic Surveys

In December 2007, DWR conducted underwater topographic levee surveys of 111 miles of levee-protected waterways, gathering data along the Sacramento, American, San Joaquin and Calaveras rivers. The sonar imagery will aid in more concisely identifying areas of levee erosion as part of the overall geotechnical levee evaluation. Funding was provided by Propositions 84 and 1E, approved by voters the year before.

## Climate Change

California water planners are concerned about climate change and its potential effects on water resources. Californians rely on two water projects: the SWP and federal Central Valley Project (CVP). These complex water storage and conveyance systems are operated by DWR and Reclamation for water supply, flood management, environmental protection, and recreational uses.

Legislative mandates, Executive Order S-3-05, and the latest update to the *California Water Plan* call for more quantitative assessments of climate change effects. To address these concerns, DWR and Reclamation formed a joint Climate Change Work Team to provide qualitative and quantitative information to managers on potential effects and risks of climate change to California's water resources.

In 2007, DWR participated in a climate change summit, co-sponsored a climate change workshop, and co-hosted a climate change water adaptation summit. DWR also signed a memorandum of agreement with the National Oceanic and Atmospheric Administration (NOAA) to establish a process for coordinating climate research applicable to water management.

DWR launched a climate change web portal to provide information about DWR's climate change activities, as well as basic information, resources, and research related to climate change.

## Yearly Activities Summary

### 2007 Precipitation and Water Storage

Water stored and delivered by the SWP conservation and transportation facilities originates from rainfall and snowmelt in northern and central California watersheds, where most of the State's precipitation occurs. DWR monitors and records annual precipitation and runoff during each water year, which begins on October 1 and ends on September 30.

### *Precipitation and Snowpack in Water Year 2006–2007*

California experienced a dry year with lower than average precipitation during water year 2006–2007 (covering October 2006 through September 2007). The State, as a



whole, received precipitation at 65 percent of average, as compared to 136 percent of average in 2005–2006. During the fourth week of February, statewide average snow water content peaked at 17 inches of water content. Not only was the peak storage observed a month earlier than the historical average April 1 peak date, the February 28 peak was only 58 percent of the April 1 average. These snow conditions compared poorly with those experienced during the 2005–2006 water year, which peaked at 161 percent. The Northern Sierra Eight Station Index finished with 37.3 inches of precipitation, or 74 percent of average.

### **Runoff**

Statewide river runoff totaled 53 percent of average in water year 2006–2007. Sacramento River and San Joaquin River region runoff were 55 percent and 42 percent of average, respectively.

The Sacramento Valley Water Year Hydrologic Classification (40-30-30 Index) and the San Joaquin Valley Water Year Hydrologic Classification (60-20-20 Index) were dry and critical, respectively, based on observed data for water year 2006–2007.

### **Water Year 2006–2007 Storage Totals**

At the end of water year 2006–2007, storage in all SWP reservoirs was 2.72 maf or 50 percent of maximum storage, compared to 4.44 maf or 82 percent of minimum storage at the end of water year 2005–2006. The average end-of-month total storage for water year 2006–2007 in major SWP reservoirs was 3.98 maf. End-of-water-year storage on September 30, 2007 at Lake Oroville was 1.57 maf, about 1.26 maf less than the previous water year.

### **Calendar Year 2007 Storage Total**

The total storage in major SWP reservoirs was about 2.45 maf at the end of calendar year 2007, compared with 4.49 maf in 2006.

### **Water Year 2007–2008 October–December Water Conditions**

The last three months of calendar year 2007 were also the first three months of water year 2007–2008. At the end of October, water year runoff totals were 90, 47 and 46 percent of average for the Sacramento River, San Joaquin River and Tulare Lake regions, respectively. December runoff totals dropped to 47, 22 and 35 percent of average, respectively, for the three regions. For more information see Chapter 8, Water Supply.

### **2007 Water Supplies, Contracts, and Deliveries**

#### **2007 Water Deliveries**

DWR approved an initial Table A allocation of 2.47 maf, or roughly 60 percent of most SWP contractor requests for Table A water deliveries, on November 30, 2006. The final allocation on May 23, 2007 remained at 60 percent, significantly below the historic 100 percent final allocation of the previous year.

In 2007, 4,061,696 af was delivered to 27 long-term contractors and 26 other agencies, as follows:

- 2,081,217 af of Table A water, which includes 94,762 af of 2006 carryover water;
- 309,973 af of Article 21 water;
- 115,204 af of Flexible storage withdrawal water;
- 2,581 af of SWP water for recreation and fish and wildlife;
- 1,258,278 af of nonproject water delivered to satisfy settlement agreements and agreements with SWP contractors for local water supplies; and
- 114,492 af of water delivered to satisfy agreements between the SWP and CVP.

Table ES-1 shows SWP water deliveries by category for 1962 through 2007. For more

**Table ES-1 SWP Water Delivered by Category, 1962–2007 (Acre-feet) <sup>a</sup>**

Year	Table A Water			Other SWP Water Deliveries					Total Deliveries
	Municipal and Industrial	Agricultural	Total	Article 21/Unscheduled		Other Water <sup>b</sup>	Feather River Diversions <sup>c</sup>	Fish & Wildlife/ Recreation Water	
				Municipal and Industrial	Agricultural				
1962	—	—	—	—	—	9,704	7,499	—	17,203
1963	—	—	—	—	—	13,212	16,049	—	29,261
1964	—	—	—	—	—	21,743	17,891	—	39,634
1965	—	—	—	—	—	35,985	27,425	—	63,410
1966	—	—	—	—	—	59,599	33,361	—	92,960
1967	5,563	5,791	11,354	0	0	45,225	24,639	—	81,218
1968	86,541	85,168	171,709	10,000	111,534	1,214	903,367	—	1,197,824
1969	63,956	129,064	193,020	0	72,397	8,692	832,454	—	1,106,563
1970	83,415	150,578	233,993	0	131,848	25,401	804,320	—	1,195,562
1971	93,776	263,564	357,340	0	294,581	35,438	825,886	8	1,513,253
1972	186,796	425,005	611,801	0	422,322	53,848	875,529	6,489	1,969,989
1973	297,497	395,391	692,888	0	294,916	29,540	851,285	1,155	1,869,784
1974	423,982	450,093	874,075	0	412,453	31,493	963,956	2,118	2,284,095
1975	670,492	553,498	1,223,990	356	620,329	46,995	924,696	3,377	2,819,743
1976	631,876	741,126	1,373,002	4,147	547,538	103,546	1,018,653	1,745	3,048,631
1977	354,930	218,966	573,896	0	0	410,991	624,497	1,111	1,610,495
1978	782,625	529,740	1,312,365	0	16,215	177,245	836,864	1,691	2,344,380
1979	692,888	711,404	1,404,292	0	646,830	431,693	933,067	1,766	3,417,648
1980	726,545	784,946	1,511,491	52,200	350,017	40,269	925,750	2,131	2,881,858
1981	1,053,273	835,852	1,889,125	18,920	889,508	283,310	993,785	4,688	4,079,336
1982	916,014	822,042	1,738,056	140	214,994	144,267	819,586	4,646	2,921,689
1983	482,749	701,370	1,184,119	0	13,019	172,030	633,778	7,849	2,010,795
1984	725,799	861,794	1,587,593	3,663	259,254	366,273	891,128	7,040	3,114,951
1985	983,341	929,424	1,912,765	9,638	292,206	474,417	924,049	4,033	3,617,108
1986	998,611	1,009,295	2,007,906	2,595	21,755	177,176	843,040	3,865	3,056,337
1987	1,079,983	1,033,932	2,113,915	6,949	107,958	375,810	882,301	7,672	3,494,605
1988	1,308,071	1,068,302	2,376,373	0	0	520,375	884,877	4,889	3,786,514
1989	1,602,543	1,251,204	2,853,747	0	0	474,559	830,500	8,135	4,166,941
1990	1,876,072	706,079	2,582,151	0	90	424,697	875,099	9,262	3,891,299
1991	536,669	12,444	549,113	3,521	0	543,582	565,395	4,879	1,666,490
1992	955,687	455,112	1,410,799	1,156	0	166,992	613,978	2,605	2,195,530
1993	1,069,258	1,243,978	2,313,236	0	0	256,853	822,589	2,609	3,395,287
1994	1,134,992	614,359	1,749,351	48,150	64,475	236,739	874,018	8,200	2,980,933
1995	801,570	1,165,523	1,967,093	17,984	46,346	85,560	860,077	2,575	2,979,635
1996	1,143,638	1,371,186	2,514,824	12,091	16,556	252,346	1,005,148	3,907	3,804,872
1997	1,220,200	1,040,183	2,260,383	2,814	18,618	322,000	993,211	4,146	3,601,172
1998	865,795	860,724	1,726,519	9,982	10,306	127,405	872,738	2,108	2,749,058
1999	1,405,311	1,333,592	2,738,903	61,191	96,879	85,312	1,108,672	4,324	4,095,281
2000	1,968,161	1,231,745	3,199,906	170,302	138,483	333,384	1,085,886	4,030	4,931,991
2001	1,168,333	365,930	1,534,263	10,261	33,174	535,147	1,077,997	2,929	3,193,771
2002	1,849,052	715,805	2,564,857	9,502	27,663	272,277	1,131,880	3,694	4,009,873
2003	2,102,557	787,658	2,890,215	5,397	29,629	233,069	1,006,995	2,846	4,168,151
2004	1,951,657	643,342	2,594,999	103,890	112,949	341,922	1,171,835	2,865	4,328,460
2005	1,877,647	948,563	2,826,210	186,787	544,296	92,858	1,074,706	1,506	4,726,363
2006	1,973,268	998,583	2,971,851	293,358	327,981	119,405	1,112,551	1,936	4,827,082
2007	1,572,198	509,019	2,081,217	185,825	124,148	449,935	1,217,990	2,581	4,061,696
<b>Total</b>	<b>39,723,331</b>	<b>28,961,374</b>	<b>68,684,705</b>	<b>1,230,819</b>	<b>7,311,267</b>	<b>9,449,533</b>	<b>36,620,997</b>	<b>141,410</b>	<b>123,438,731</b>

<sup>a</sup> Note: values presented in this table reflect changes to historical delivery data as a result of an audit performed by DWR. These data supersede values presented in previous B132 editions.

<sup>b</sup> Includes water conveyed for SWP and non-SWP water contractors.

<sup>c</sup> Includes amounts of water diverted according to various water rights agreements.

information see Chapter 9, Water Contracts and Deliveries.

## Power Resources

In 2007, DWR sold 2.26 million MWh to 20 utilities and 22 power marketers for total revenues of \$138.89 million. DWR also received \$40.43 million in revenues for capacity, exchanges, and other energy-related services, including \$24.35 million for transactions made through CAISO. See Table 10-4 in Chapter 10, Power Resources, for information about energy and other services sold and revenue received, including those sold to CAISO.

Also in 2007, DWR amended one of four power contracts with Calpine Energy Services, reducing both the amount to be purchased and the rate to be paid. The contract amendment was part of a larger effort by the State to transition out of the power supply business following the 2000–2001 energy crisis.

The sidebar, State Water Project Power Generation and Consumption in 2007, summarizes amounts of power generated and consumed by SWP. For more information, see Chapter 10, Power Resources.

## Oroville Relicensing Settlement Agreement

The original 50-year term Federal Energy Regulatory Commission (FERC) Project Number 2100 hydropower license for operation of the Oroville Facilities, expired January 31, 2007. The project continued to operate under an annual license issued by FERC February 1, 2007.

U.S. Fish and Wildlife Service (USFWS) issued the terrestrial biological opinion (BO) for the project in April 2007, and in July, DWR submitted the biological assessment and essential fish habitat assessment evaluating the effects of the Settlement Agreement and

issuance of a new FERC license on federally listed anadromous fish.

In November, the Habitat Expansion Agreement (HEA) for Central Valley Spring-Run Chinook Salmon and California Central Valley Steelhead was signed by DWR and Pacific Gas and Electric Company (PG&E). Concurrently, the two agencies entered into the Habitat Expansion Coordination Agreement (HECA) to ensure coordinated decision making and implementation of actions to achieve the goals of the HEA.

For additional Oroville Facilities relicensing information, see Chapter 3, Environmental Programs, Chapter 10, Power Resources, and Chapter 13, Recreation.

## Financial Analysis

In 2007, DWR continued to pay bondholders as scheduled. The SWP was financially liable and was indirectly paid for by the approximately 25 million water users served by the project. Direct payment was through the 29 long-term water contractors. In 2007, the SWP handled approximately \$1,022 million in revenues and \$1,022 million in expenses. The 2007 Income Statement for the State Water Project sidebar presents a summary of the year's revenues and expenses. For more information about SWP revenues and expenditures for the year, see Chapter 14, Financial Analysis.

## Litigation

In 2007, DWR was involved in or closely monitoring court cases and other actions related to SWP management—two are highlighted as follows. (See Chapter 6, Legislation and Litigation, for further information.)

### Delta Smelt

*Natural Resources Defense Council, et al. v. Kempthorne, et al.*—The plaintiffs claim the USFWS BO fails to adequately consider

## State Water Project Power Generation and Consumption in 2007

<b>Power Generation and Consumption</b>	<b>Millions of Megawatt Hours</b>
Energy generation by SWP facilities	5.577
Energy sources and firm purchases under long-term agreements and exchanges	6.642
<b>Total Energy Available to the SWP</b>	<b>12.220</b>
Energy sales	(2.446)
<b>Net SWP Power Consumption</b>	<b>9.773</b>

## 2007 Income Statement for the State Water Project

<b>Revenues</b>	<b>Thousands of Dollars</b>
Water Contract Payments	1,045,918
Revenue Bond Cover Adjustments	(41,947)
Rate Management Adjustments	(2,998)
Other Revenues	20,914
<b>Total Operating Revenues</b>	<b>1,021,887</b>
<b>Expenses</b>	
Project Operations, Maintenance, Power, and Replacement	698,315
Deposits to Reserves	54,369
Water Bond Principal	125,298
Water Bond Interest	143,905
<b>Total Operating Expense and Debt Service</b>	<b>1,021,887</b>
<b>Net System Revenues</b>	<b>0</b>

or address the effects on delta smelt. The plaintiffs claim the opinion improperly relies on uncertain measures and the adaptive management process without adequate evidence that the measures will be undertaken and be effective. The case seeks to have the U.S. Department of the Interior and USFWS withdraw the opinion and not take any action in reliance upon it. Deadlines were set for filing motions for summary judgment for the end of December 2007.

On May 31, 2006, Plaintiffs served a 60-day notice to the Federal Defendants, NOAA, of alleged Endangered Species Act (ESA) violations. The Plaintiffs' amended complaint alleges the five salmon-run species and steelhead survival and population stability are threatened by the current and planned joint operations of the CVP and SWP. Plaintiffs request the court declare the 2004 Salmon/Steelhead BO unlawful and issue an injunction from implementation of project operations, as described in the 2004 opinion.

Chapter 6, Legislation and Litigation, presents a complete summary of legal and legislative activities and milestones in 2007.

## Flood Protection

### *"A California Challenge—Flooding in the Central Valley"*

This paper was prepared at the request of DWR by an independent panel of experts from across the nation to provide insights and recommendations on how California should deal with the special circumstances of deep floodplains in the Central Valley.

### *Flood Protection Legislation*

On October 10, the Governor signed a package of six bills relating to improved flood protection in California. One major bill renamed the Reclamation Board as the Central Valley Flood Protection Board, effective in 2008. It also mandated development of a comprehensive Central

Valley Flood Protection Plan, under board supervision.

### *Delta Flood Emergency Preparedness and Response Plan*

DWR began developing a Delta Flood Emergency Preparedness and Response Plan to improve its ability to prepare for, respond to, and recover from multiple-island levee failure within the Sacramento-San Joaquin Delta caused by a flood or seismic event. The plan objective is to minimize recovery time from such an event through preparedness, response, and actions taken.

### *FloodSAFE*

In 2006, DWR launched a comprehensive initiative called "FloodSAFE California" to address the State's flood management challenges. The FloodSAFE program is a collaborative statewide effort designed to accomplish five broad goals:

- reduce the chance of flooding;
- reduce the consequences of flooding
- sustain economic growth;
- protect and enhance ecosystems; and
- promote sustainability.

FloodSAFE programs will be funded by approximately \$700 million appropriated for fiscal year 2007–2008 from Propositions 1E and 84 bond funds.

In 2007, the FloodSAFE project team conducted public and government workshops statewide. In the workshops, DWR provided an overview of the FloodSAFE California Initiative and information on fiscal year 2007–2008 bond funding availability. Workshop participants were encouraged to initiate early stakeholder and partner dialog.

## Delta Resources and Environmental Issues

### Environmental Water Account

The Environmental Water Account (EWA) is a cooperatively managed program intended to provide beneficial environmental changes to protect the fish of the Bay-Delta Estuary and increased SWP and CVP operational flexibility for enhancement of the water supply reliability to its customers. The three management agencies—National Marine Fisheries Service (NOAA Fisheries), USFWS, and Department of Fish and Game (DFG) and the two project agencies—Reclamation and DWR, are responsible for EWA implementation.

In 2007, DWR and four governmental agencies made the Draft Supplemental Environmental Impact Statement (EIS)/EIR for EWA available for public review and comment. The document addressed changes to the regulatory and physical environment that occurred since completion of the Final EIS/EIR and the Record of Decision (ROD) in 2004.

In 2007, exports were periodically curtailed at the SWP and CVP export facilities between January and June. These actions resulted in EWA export reductions of 408,050 af to the SWP and 93,466 af to the CVP.

During water year 2007–2008, DWR and Reclamation obtained 451,472 af in acquisition assets for EWA. EWA had no carryover debt at the beginning of calendar year 2007 but by year's end, the EWA debt was 50,042 af. For more EWA information, see Chapter 3, Environmental Programs, Chapter 7, Water Supply Development and Reliability, and Chapter 9, Water Contracts and Deliveries.

### DWR Stops Pumping to Protect Delta Smelt

In May 2007, the State saw the first voluntary shutdown of the SWP pumps in the Delta to

protect fish. Limited pumping resumed 10 days later, and 5 days after that, pumping was increased to resume water deliveries.

### Delta Vision

Executive Order S-17-06 directed development of a Delta Vision to provide a sustainable management program for the Sacramento-San Joaquin Bay-Delta. The Governor appointed the Delta Vision Blue Ribbon Task Force in February 2007, which then held meetings soliciting public and scientific input on addressing Delta issues. Recommendations were published in a vision document, released in December.

### Delta Risk Management Strategy

A major State priority is determining how to make the Delta sustainable in the future. The 2000 CALFED ROD presented its Preferred Program Alternative, describing actions, studies, and conditional decisions to help improve the Delta. Included in the Preferred Program Alternative for Stage 1 implementation was the completion of a Delta Risk Management Strategy (DRMS) looking at Delta sustainability and assessing major risks to the Delta resources from floods, seepage, subsidence, and earthquakes. DRMS would also evaluate the consequences, and develop recommendations to manage the risk.

In 2007, the DRMS preliminary findings were reviewed by a CALFED scientific panel, leading to reevaluation of some of the initial DRMS analyses. Reevaluation results will be incorporated into the final DRMS report, scheduled for 2008.

### North Delta Program

The North Delta Program is part of the CALFED Conveyance Program. Several improvements to North Delta conveyance facilities proposed in the CALFED ROD are being considered, and DWR has been evaluating them in cooperation with other agencies.

During 2007, DWR continued overseeing preparation of the public draft EIR, incorporating responses to comments received on the administrative draft EIR.

Proposed project actions and alternatives have been subdivided into two groups for analysis in the EIR.

Group I includes levee modifications on McCormack-Williamson Tract, raising downstream levees to offset potential hydraulic impacts caused by these modifications, restoration of McCormack-Williamson Tract and the Grizzly Slough property, and dredging along the Mokelumne River.

Group II includes several project actions on Staten Island and Mokelumne River levee modifications and dredging.

See Chapter 2, Delta Resources, for more North Delta Program information.

### Watershed Grant Awards

DWR awarded more than \$10 million in CALFED grants to 27 watershed projects throughout the State, selecting among 95 applications. The grants are to “study, restore and value” watersheds using money from Proposition 50 bond sales, approved by voters in 2002.

### Quagga Mussel Monitoring

The quagga mussel, *Dreissena rostriformis bugensis*, and the closely related zebra mussel, *D polymorpha*, are invasive aquatic species. The mussels colonize hard or soft substrates, but tend to attach to structures, clogging power generation facility cooling and pumping plant systems and trash racks, screens, internal piping, strainers, and filters used in municipal, industrial, and agricultural water delivery systems. The resulting damage to infrastructure can cost billions of dollars in maintenance or repair.

Quagga mussels were discovered in January 2007 in Lake Mead, and subsequent surveys found them in Lakes Mohave and Havasu and part of the Colorado River Aqueduct (CRA) that serves Southern California. It was the first discovery of these mussels west of the Continental Divide. They are believed to have entered the Colorado River system in boats trailered there from infested waters in the Midwest. In August 2007 they were discovered in San Diego and Riverside county reservoirs served by the CRA.

DWR began monitoring the SWP for quagga mussels shortly after the mussels were first detected in California. No mussels were found in the SWP or its associated watersheds.

## Status of Threatened or Endangered Species Listings

### North American Green Sturgeon

In 2006, NOAA Fisheries published a final rule listing the Southern Distinct Population Segment (DPS) of North American green sturgeon as threatened under the federal ESA. In 2007, the Center for Biological Diversity filed a notice of intent to sue NOAA Fisheries for failing to designate critical habitat for the green sturgeon Southern DPS, as required by ESA. A settlement agreement was reached later in the year, with a critical habitat designation proposal expected in 2008.

### Delta Smelt

In 1993, delta smelt was designated as threatened under the ESA. At the time of the ruling, delta smelt populations had declined nearly 90 percent since the 1970s, and abundance has continued since. In 2006, the Center for Biological Diversity, the Bay Institute, and the Natural Resources Defense Council petitioned USFWS to change the delta smelt status from threatened to endangered under the ESA. In 2007, the Center for Biological Diversity filed a notice of intent to sue USFWS for failure to respond

to the 2006 petition. On June 7, 2007, the California Fish and Game Commission accepted a petition to consider uplisting the delta smelt to endangered species status under CESA, initiating a species status review by DFG.

### **Longfin Smelt**

In 2007, the Bay Institute, the Center for Biological Diversity and the Natural Resource Defense Council petitioned USFWS to list the Bay-Delta longfin smelt population as threatened or endangered under the federal ESA, and petitioned the California Fish and Game Commission to list the fish statewide under CESA. The petitions were in response to four consecutive years of population declines and related issues.

For more information on listed species, see Chapter 3, Environmental Programs.

### **Pelagic Organism Decline in the Upper San Francisco Estuary**

Long-term monitoring by the Interagency Ecological Program (IEP) showed continued marked declines in pelagic fishes in the upper San Francisco Estuary in 2007. Affected populations include delta smelt, longfin smelt, striped bass, and threadfin shad. IEP formed a pelagic organism decline (POD) work team to evaluate the potential causes. The POD work team developed a pelagic fish work plan for 2006–2007. Major findings through 2007 were synthesized using two conceptual modeling approaches. Details can be found in the “Pelagic Organism Decline Progress Report: 2007 Synthesis of Results.” Many studies initiated either by the POD work team or others are still in progress and will continue to provide important POD information.

### **Lake Davis Northern Pike Eradication**

Lake Davis, in the upper Feather River watershed, was treated for the second

time in a decade in an attempt to eliminate invasive northern pike. If left unchecked, it was feared the pike would escape the lake and make their way downstream to Lake Oroville and eventually, the Sacramento River system.

Lake Davis is an important SWP storage reservoir as well as a water supply for nearby communities and a recreational lake. DFG treated the lake with the piscicide rotenone in September 2007. Closure of the lake’s outlet at the dam assured no treated water would escape into Big Grizzly Creek, below. Following treatment and complete dispersal of the treatment compounds, DFG plans to restock the lake with trout and reopen it to the public in 2008, while continuing to monitor for the possible presence of northern pike.

### **DWR Scientists Discover New Invertebrate Species**

As a result of biological fieldwork conducted in 2004 and 2005, a previously unknown invertebrate species was determined to comprise a large proportion of “insect drift” present in the Sacramento River’s Yolo Bypass. The discovery of *Hydrobaenus saetheri* was formally published in 2007.

During the DWR research, difficulties were encountered in identifying the midge species. DWR scientists consulted with a world-renowned midge expert at U.C. Davis who determined that it was a new species of midge. The Yolo Bypass conveys water only during high-water events on the river and the *Hydrobaenus* larva only hatch during these intermittent inundations. When present in the bypass, the midge larvae are a significant food source for young Chinook salmon and Sacramento splittail.

### **SWP Security Measures**

Security and protection of the SWP remain primary goals for DWR. After the September 2001 attacks, DWR further



increased security, including regulating access to, and closely monitor activities at SWP facilities and DWR offices. SWP facilities are now limited to the visitor centers and noncritical facilities such as the Delta Fish Facilities, Feather River Fish Hatchery, and administration building overlooks. All SWP recreational reservoirs are open to the public, but boats are not allowed within 500 feet of dams or any associated structures. Signs at each recreational reservoir alert the public to zones not accessible to them.

SWP operations are closely monitored and DWR staff are vigilant in maintaining a secure environment. Security patrols are more frequent than previously, and plans are in place to address potential or actual acts of terrorism. Security system improvements continue, in conjunction with Reclamation and other federal and State agencies.

## SWP Milestones through the Decades

### Fifty Years Ago–1957

In February 1957, the Legislature made the first appropriation of \$25,190,000 to the DWR for actual construction of the SWP.

Preparation for the construction of Oroville Dam began in May 1957. The first contract covered constructing tunnels 4 and 5 on the Western Pacific Railroad relocation, necessary to clear the dam and reservoir sites.

The State Water Resources Board published Bulletin 3, “The California Water Plan”—the first California Water Plan. It presented preliminary plans for developing all of the state’s water resources to meet its ultimate water needs.

### Twenty Years Ago–1987

Construction continued on the first phase of the California Aqueduct East Branch

enlargement project, to provide an additional flow of 1,500 to 1,683 cubic feet per second (cfs). Raising the canal lining to accommodate the increased flow in Stage I was completed in 1987.

Contracting and design work continued on several projects, including Harvey O. Banks Delta Pumping Plant completion, Phase II of the North Bay Aqueduct, Pearblossom Pumping Plant enlargement, Mojave Siphon Powerplant construction and Devil Canyon Powerplant expansion.

In March 1987, DWR, DFG, USBR, and Suisun Resource Conservation District signed the Suisun Marsh Preservation Agreement (SMPA) to mitigate for impacts on Marsh salinity from the CVP, SWP, and other upstream diversions.

In November, after more than 25 years of negotiations and Congressional approval, DWR and Reclamation sign the Coordinated Operations Agreement. It ushers in a new era of cooperation in operating the SWP and CVP.

### Ten Years Ago–1997

In early 1997 major floods hit California. The 1997 flood caused 48 of California’s 58 counties to be declared disaster areas and nearly \$2 billion in damages. Oroville Dam released a record 160,000 cfs through the spillway.

In response to concerns raised by the flooding, the Governor formed the Flood Emergency Action Team (FEAT). The final FEAT report published in 1997 outlined FEAT’s findings after gathering input from the public and evaluating existing flood control facilities and emergency agency responses, and listed their recommendations to enhance the capability to reduce impacts from future flood events.

In early February 1997, based on a 99-percent exceedence, DWR approved 100 percent of the water delivery requested by the 29 long-term State Water Contractors. Although one of the driest springs on record followed and adequate water supply became a growing concern, final allocations remained at 100 percent through working with the contractors, rescheduling, and drawing groundwater banked by the SWP in Kern County groundwater basins.


On July 18, 1997, nearly 300 State and local leaders gathered to celebrate the completion and dedication of the 100-mile long Coastal Aqueduct water project, which delivers SWP water to San Luis Obispo and Santa Barbara counties. The project was a joint effort between DWR and the Central Coast Water Authority.



# Chapter 1

## The State Water Project

*The California Aqueduct.*



This chapter primarily provides background on the State Water Project (SWP), including brief descriptions of SWP facilities, planning, construction, power operations, financing, contracting agencies, and the project's many uses and functions. It also provides a glimpse of California history, with a look at the processes and decisions that went into the creation of the largest state-built water project in the country.

Chapters 2 through 15 provide more detail on significant events and specific topics related to management of the SWP in calendar year 2007. At the end of the bulletin, Appendix B presents data and computations used to determine the SWP Contractors' Statements of Charges for 2009.

*Information in this chapter was contributed by the Division of Operations and Maintenance and the State Water Project Analysis Office.*

California's diverse geography contains both the highest and lowest elevations in the coterminous United States, with a resulting diversity of climate that ranges from desert to alpine to subtropical. In a typical year, some areas receive as little as 2 inches of rain, while others receive more than 100 inches. This diversity of geography and climate creates an intricate and constantly changing pattern of water supplies, which, in turn, creates enormous challenges in managing this vital resource.

## The State Water Project

Like present-day Californians, the earliest settlers faced the problem of how best to conserve, control, and deliver water. Remains of aqueducts, canals, and dams are still found near some of California's original missions. The first recorded aqueduct, built in 1770 to serve the San Diego mission, was 6 miles long. In the early twentieth century, several cities, including San Francisco and Los Angeles, built aqueducts to convey water from the Sierra Nevada to other parts of the State.

In 1951, after many years of discussion and study, the Legislature authorized construction of a water storage and supply system to capture and store rainfall and snowmelt runoff in Northern California and deliver it to areas of need throughout the State. Eight years later, the Legislature passed the Burns-Porter Act, which provided the mechanism for obtaining funds necessary to construct the initial facilities. In 1960, California voters approved an issue of \$1.75 billion in general obligation bonds, as authorized in the act, thereby securing funds to build the State Water Project (SWP). In 1962, the first water was delivered through a portion of the South Bay Aqueduct to two long-term contracting agencies in Alameda County.

Today the SWP, built, operated, and managed by the Department of Water Resources (DWR), is the largest state-built,

multipurpose, user-financed water project in the country. It was designed and built to deliver water, control flooding, generate power, provide recreational opportunities, and enhance habitat for fish and wildlife. SWP water irrigates about 750,000 acres of farmland, mainly in the south San Joaquin Valley. Approximately 25 million of California's estimated 37 million residents benefit from SWP water.

## Precipitation and Runoff

The water stored and delivered by the SWP originates from rainfall and snowmelt runoff in Northern and Central California's watersheds, where most of the State's precipitation occurs.

Since 1968, DWR has monitored and recorded annual precipitation and runoff, because precipitation, snowpack, and the rate and amount of snowmelt help determine how much water the SWP can deliver in any given year. The DWR-designated water year is October 1 through September 30.

## Water Delivery Facilities

The SWP depends on a complex system of dams, reservoirs, power plants, pumping plants, canals, and aqueducts to deliver water. Although initial transportation facilities were essentially completed in 1973, other facilities have since been built, and still others are either under construction or are planned to be built, as needed.

The SWP facilities include 30 dams (29 of which impound water), 20 reservoirs, 29 pumping and generating plants, and approximately 700 miles of aqueducts in total. Figure 1-1 shows the names and locations of primary water delivery facilities.

Existing long-term SWP water supply contracts call for the annual delivery of up to 4,129,306 acre-feet (af; one acre-foot is approximately 325,851 gallons) of Table A water during 2007 through SWP facilities, gradually increasing to a maximum of 4,172,786 af by 2016. Some changes have occurred since the long-term water contracts were signed in the 1960s, including population growth variations, differences in local use, local water conservation programs, and conjunctive-use programs. The SWP delivered 1,986,455 af of approved 2007 Table A water to long-term SWP water contractors' service areas in 2007. Demands for SWP water are expected to increase as California's population continues to grow.

## Project Design

Water from rainfall and snowmelt runoff is stored in SWP conservation facilities and delivered via SWP transportation facilities to water agencies and districts in the Southern California, Central Coastal, San Joaquin Valley, South Bay, North Bay, and Upper Feather River areas.

Three small reservoirs—Lake Davis, Frenchman Lake, and Antelope Lake—are the northernmost SWP facilities. Situated on Feather River tributaries in Plumas County, these lakes are used primarily for recreation. They also provide water to the City of Portola and local agencies that have water rights agreements with DWR.

Downstream from these lakes lies Lake Oroville, the keystone of the SWP. Lake Oroville conserves water from the Feather River watershed. Created by Oroville Dam, the tallest earthfill dam in the Western

Hemisphere, Lake Oroville is the project's largest storage facility with a capacity of about 3.5 million af.

Releases from Lake Oroville flow down the Feather River into the Sacramento River, which drains the northern portion of California's great Central Valley. The Sacramento River flows into the Sacramento-San Joaquin Delta, comprising 738,000 acres of land interlaced with channels that receive runoff from 40 percent of the State's land area. The SWP, federal Central Valley Project (CVP), and local agencies all divert water from the Delta.

From the northern Delta, Barker Slough Pumping Plant diverts water for delivery to Napa and Solano counties through the North Bay Aqueduct, which was completed in 1988. Near Byron, in the southern Delta, the SWP diverts water into Clifton Court Forebay for delivery south of the Delta. Banks Pumping Plant lifts water from Clifton Court Forebay into the California Aqueduct, which flows to Bethany Reservoir. From Bethany Reservoir, the South Bay Pumping Plant lifts water into the South Bay Aqueduct to supply Alameda and Santa Clara counties. The South Bay Aqueduct provided initial deliveries in 1962 and has been fully operational since 1965.

Most of the water delivered to Bethany Reservoir from Banks Pumping Plant flows into the California Aqueduct. This 444-mile-long main aqueduct conveys water to the agricultural lands of the San Joaquin Valley and to the urban regions of Southern California.

The California Aqueduct winds along the west side of the San Joaquin Valley. It transports water to O'Neill Forebay, Gianelli Pumping-Generating Plant, and San Luis Reservoir. San Luis Reservoir has a storage capacity of more than 2 million af and is jointly owned by DWR and the Bureau of Reclamation (Reclamation). DWR's share of gross storage in the reservoir is 1,062,183 af.



Figure 1-1 Names and Locations of Primary Water Delivery Facilities, December 31, 2007

Generally, water is pumped into San Luis Reservoir from late fall through early spring, where it is temporarily stored for release back to the California Aqueduct to meet summertime peaking demands of SWP and CVP water contractors.

Both SWP water not stored in San Luis Reservoir and water eventually released from San Luis flows south through the San Luis Canal, a portion of the California Aqueduct jointly owned by DWR and Reclamation.

As the water flows through the San Joaquin Valley, numerous turnouts convey it to farmlands within the service areas of the SWP and CVP. Along its journey, this water is lifted more than 1,000 feet by four pumping plants—Dos Amigos, Buena Vista, Teerink, and Chrisman—before reaching the foot of the Tehachapi Mountains.

In the southern San Joaquin Valley, near Kettleman City, Phase I of the Coastal Branch Aqueduct serves agricultural areas west of the California Aqueduct. In August 1997, completion of Phase II extended the Coastal Branch Aqueduct to serve municipal and industrial water users in San Luis Obispo and Santa Barbara counties.

The remaining water conveyed by the California Aqueduct is delivered to Southern California, home to roughly two-thirds of California's population. Before it can be delivered, the water must first cross the Tehachapi Mountains. Fourteen 80,000-horsepower pumps at Edmonston Pumping Plant, situated at the foot of the mountains, raise the water 1,926 feet—the highest single lift of any pumping plant in the world. The water enters 8.5 miles of tunnels and siphons as it flows into Antelope Valley, where the California Aqueduct divides into two branches: the East Branch and the West Branch.

The East Branch carries water through Alamo Powerplant, Pearblossom Pumping Plant, and Mojave Siphon Powerplant into

Silverwood Lake in the San Bernardino Mountains. From Silverwood Lake, water flows through the San Bernardino Tunnel to Devil Canyon Powerplant. Water continues down the East Branch through the Santa Ana Pipeline to Lake Perris, the southernmost SWP reservoir.

The East Branch Extension is a nearly 33-mile pipeline linking parts of service areas for San Bernardino Valley Municipal Water District and San Geronimo Pass Water Agency to the California Aqueduct. The East Branch Extension, Phase I, carries water from Devil Canyon Powerplant Afterbay to Cherry Valley, bringing water to Yucaipa, Calimesa, Beaumont, Banning, and other communities. Phase II, when completed, will assist with this delivery.

Water in the West Branch flows through Oso Pumping Plant, Quail Lake, and then from the Peace Valley Pipeline through Warne Powerplant into Pyramid Lake in Los Angeles County. From there it flows through the Angeles Tunnel, Castaic Powerplant, Elderberry Forebay, and into Castaic Lake, terminus of the West Branch. Castaic Powerplant is operated by the Los Angeles Department of Water and Power.

The energy needed to operate the SWP, the largest single user of electrical power in California, comes from a combination of its own hydroelectric and coal-fired generating plants and power purchased from and exchanged with other utilities. The coal-fired plant and the project's eight hydroelectric power plants, including three pumping-generating plants, produce enough electricity in a normal year to supply about two-thirds of the SWP's necessary operating power.

Tables 1-1 through 1-5 present statistical information about primary storage facilities, primary dams, pumping plants, power plants, and aqueducts. Additional information regarding power operations can be found in Chapter 10, Power Resources.



**Table 1-1 Physical Characteristics of Primary Storage Facilities**

Facility	Data at Absolute Maximum Elevation		
	Gross Capacity (Acre-feet)	Surface Area (Acres)	Shoreline (Miles)
Antelope Lake	22,600	930	15
Frenchman Lake	55,500	1,580	21
Lake Davis	84,400	4,030	32
Lake Oroville	3,537,600	15,810	167
Thermalito Forebay	11,800	630	10
Thermalito Afterbay	57,000	4,300	26
Thermalito Diversion Pool	13,400	320	10
Clifton Court Forebay	31,300	2,180	8
Bethany Reservoir	5,100	180	6
Lake del Valle	77,100	1,060	16
San Luis Reservoir	2,027,800	12,520	65
SWP storage, 1,062,183 af			
O'Neill Forebay	56,400	2,700	12
SWP storage, 29,500 af			
Los Banos Reservoir	34,600	620	12
Little Panoche Reservoir	5,600	190	6
Quail Lake	7,600	290	3
Pyramid Lake	171,200	1,300	21
Elderberry Forebay	32,500	500	7
Castaic Lake	323,700	2,240	29
Silverwood Lake	75,000	980	13
Lake Perris	131,500	2,320	10

## Future Planning and Construction

SWP aqueduct facilities were initially designed and constructed to provide service to all agencies to meet their water delivery needs up to 1990. Project water conservation reservoirs were planned to be constructed in stages as water demands increased. Oroville and San Luis were the first SWP conservation reservoir facilities constructed. Additional facilities were scheduled to meet increased demands. It was anticipated that population

growth in delivery service areas and water supply areas of origin would influence the final schedule for additional SWP facilities. Increasingly, issues such as escalating costs, environmental concerns, and increased non-SWP demands for limited water supplies have become important factors affecting the planning and construction of new facilities.

In response to changes in water management policy, DWR continues to reassess plans for additional facilities that will incorporate increased environmental safeguards while also increasing the SWP delivery yield. Developing these plans involves the time consuming process of finding technically suitable projects and satisfying the many complex and dynamic environmental procedures, laws, and regulations.

Planners are also concerned about climate change and its potentially serious effects on water resources. Temperature increases may affect water demand and aquatic ecosystems. Projected increases in air temperature may lead to changes in the amount, timing, and form of precipitation—rain or snow, changes in the volume and timing of runoff, Delta water quality changes due to sea-level rise, and changes in the amount of irrigation water needed due to modified evapotranspiration rates.

The ability of the SWP and CVP to meet the water demands of their customers and the environment depends on the accumulation of mountain snow and subsequent spring and summer snow-melt runoff. A warming climate may reduce this natural water storage mechanism.

To address these concerns, DWR and Reclamation formed a joint Climate Change Work Team to provide qualitative and quantitative assessments of the potential risks and effects of climate change on California's water resources. The team will regularly update decision makers on climate

**Table 1-2 Physical Characteristics of Primary Dams**

Facility	Crest Elevation (Feet)	Structural Height (Feet)	Crest Length (Feet)	Structural Volume (Thousands Cubic Yards)
Antelope	5,025	120	1,320	380
Frenchman	5,607	139	720	537
Grizzly Valley	5,785	132	800	253
Oroville	922	770	6,920	80,000
Thermalito Diversion	233	143	1,300	154
Thermalito Forebay	231	91	15,900	1,840
Thermalito Afterbay	142	39	42,000	5,020
Clifton Court Forebay	14	30	36,500	2,440
Bethany	250	121	3,940	1,400
Del Valle	773	235	880	4,150
Sisk	554	385	18,600	77,645
O'Neill Forebay	233	88	14,350	3,000
Los Banos Detention	384	167	1,370	2,100
Little Panoche Detention	676	152	1,440	1,210
Pyramid	2,606	400	1,090	6,800
Elderberry Forebay	1,550	200	1,990	6,000
Castaic	1,535	425	4,900	46,000
Cedar Springs	3,378	249	2,230	7,600
Perris	1,600	128	11,600	20,000
Crafton Hills	2,932	95	500	144

**Table 1-3 Pumping Plant Characteristics**

Facility	Number Of Units	Normal Static Head (Feet)	Total Flow at Design Head (cfs)	Total Motor Rating (hp)
Thermalito	3 (p-g) <sup>a</sup>	85-102	9,120	120,000
Hyatt	3 (p-g) <sup>a</sup>	500-625	5,610	519,000
Barker Slough	9	95-120	228	4,800
Cordelia	11	138		
Banks	11	236-252	10,670	333,000
South Bay	9	566	330	27,750
Del Valle	4	0-38	120	1,000
Gianelli	8 (p-g) <sup>a</sup>	99-327	11,000	504,000
Dos Amigos	6	107-125	15,450	240,000
Las Perillas	6	55	461	4,050
Badger Hill	6	151	454	11,750
Devil's Den <sup>b</sup>	6	521	134	10,500
Bluestone <sup>b</sup>	6	484	134	10,500
Polonio Pass <sup>b</sup>	6	533	134	10,500
Buena Vista <sup>b</sup>	10	205	5,405	144,500
Teerink <sup>b</sup>	9	233	5,445	150,000
Chrisman <sup>b</sup>	9	518	4,995	330,000
Edmonston <sup>b</sup>	14	1,926	4,480	1,120,000
Oso	8	231	3,252	93,800
Pearblossom	9	540	2,575	203,200
Greenspot	4	382	50	3,900
Crafton Hills	3	613	40	4,000
Cherry Valley	2	130	75	300

<sup>a</sup>The term p-g indicates pumping-generating units.

<sup>b</sup>These plants have one unit in reserve.

**Table 1-4 Power Plant Characteristics, by Type and Facility**

Type and Facility	Number of Units	Normal Static Head (Feet)	Total Flow at Design Head (cfs)	Net Dependable Capacity (MW)	Nameplate Capacity (MW)
<b>Hydro</b>					
Thermalito Diversion Dam	1	63-77	615	3	3
Thermalito	4 (3 p-g) <sup>a</sup>	85-102	17,400	114	114
Hyatt	6 (3 p-g) <sup>a</sup>	410-676	16,950	645	645
Gianelli (total)	8 p-g <sup>a</sup>	99-327	16,960	363	424
Alamo	1	115-141	1,740	15	17
Warne	2	719-739	1,600	67	74
Mojave Siphon	3	81-136	2,880	29	30
Devil Canyon	4	1,406	2,940	235	276
Castaic	7 (6 p-g) <sup>a</sup>	900-1,050	20,820	1,128	1,254
<b>Coal</b>					
Reid Gardner, Unit 4 (total) SWP share of generation <sup>c</sup>	1 <sup>b</sup>			234	275

<sup>a</sup> The term p-g indicates pumping-generating units.

<sup>b</sup> Life of the plants is expected to extend through 2013.

<sup>c</sup> SWP ownership share in Reid Gardner, Unit 4, is 67.8%.

**Table 1-5 Total Miles of Aqueducts**

Facility	Channel and Reservoir	Canal and Siphon	Pipeline and Discharge Line	Tunnel	Total
Grizzly Valley Pipeline	0.0	0.0	6.0	0.0	6.0
Thermalito Power Canal and Tail Channel	1.5	1.9	0.0	0.0	3.4
North Bay Aqueduct	0.0	0.0	27.6	0.0	27.6
South Bay Aqueduct (including del Valle Branch)	0.3	10.7	31.9	1.7	44.6
<i>Subtotal</i>	<i>1.8</i>	<i>12.6</i>	<i>65.5</i>	<i>1.7</i>	<i>81.6</i>
California Aqueduct					
Clifton Court Forebay to O'Neill Forebay	4.5	61.9	0.3	0.0	66.7
O'Neill Forebay to Kettleman City	4.1	101.4	0.2	0.0	105.7
Kettleman City to Edmonston Pumping Plant	0.0	120.1	0.9	0.0	121.0
Edmonston Pumping Plant to Tehachapi Afterbay	0.0	0.2	1.9	7.9	10.0
Tehachapi Afterbay to Lake Perris	4.0	97.8	34.3	3.9	140.0
<i>Subtotal</i>	<i>12.6</i>	<i>381.4</i>	<i>37.6</i>	<i>11.8</i>	<i>443.4</i>
California Aqueduct Branches					
Coastal Branch	0.0	14.1	98.7	2.7	115.5
West Branch	9.7	9.3	5.8	7.1	31.9
East Branch Extension					
Devil Canyon Powerplant to Greenspot Pumping Station	0.0	0.0	16.2	0.0	16.2
Greenspot Pumping Station to Noble Creek Terminus	0.0	0.0	16.4	0.0	16.4
<i>Subtotal</i>	<i>9.7</i>	<i>23.4</i>	<i>137.1</i>	<i>9.8</i>	<i>180.0</i>
<b>Total</b>	<b>24.1</b>	<b>417.4</b>	<b>240.2</b>	<b>23.3</b>	<b>705.0</b>

change impacts, the ability of existing facilities to accommodate these impacts, and available mitigation measures.

In response to changes brought about by population growth, environmental concerns, climate change, and other factors, DWR continues to plan, design, and construct transportation and power-producing facilities for the SWP. For a more information on current SWP planning and construction, see Chapter 12, Engineering and Real Estate. Information about prior construction activities can be found in previous issues of Bulletin 132 available online at <http://www.water.ca.gov/swpao/bulletin.cfm>.

## Methods of Financing

Project facilities have been constructed with several general types of financing: general obligation bonds and tideland oil revenues (under the Burns-Porter Act, which was approved by the Legislature in 1959, and the bond issue approved by voters in 1960); revenue bonds; and capital resources revenues. Repayment of these funds, and the operations, maintenance, power, and replacement costs associated with water supply, are paid by the 29 agencies and districts that have long-term contracts with DWR for the delivery of SWP water. Costs are repaid as debt service on the bonds comes due.

## Long-Term Contracting Agencies

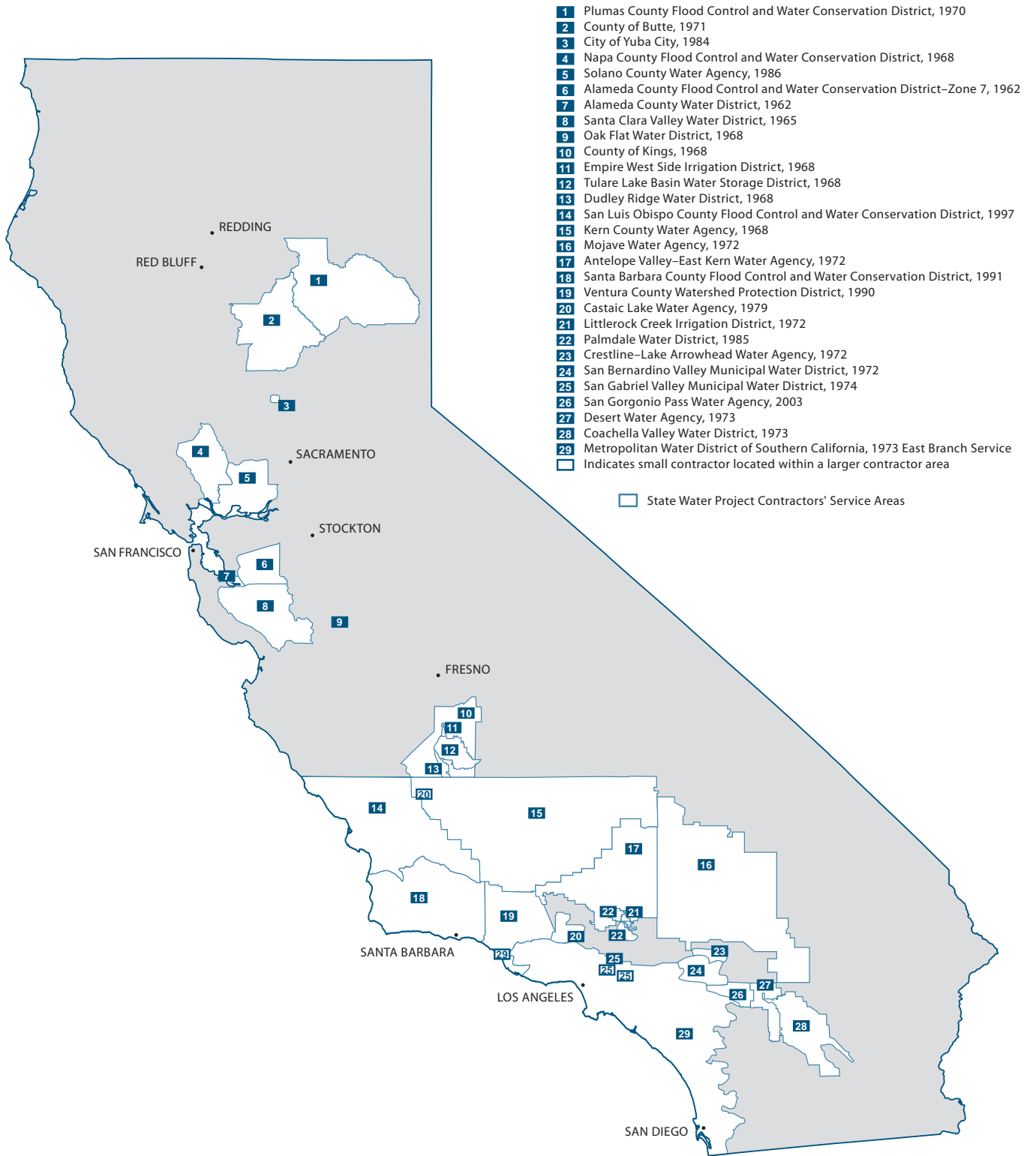
From 1963 through 1967, 32 agencies or districts signed long-term water supply contracts with DWR. However, in 1965, the City of West Covina was annexed to the Metropolitan Water District of Southern California, and in 1981, Hacienda Water District was assigned to Tulare Lake Basin Water Storage District. On January 1, 1992, Castaic Lake Water Agency assumed all rights and obligations granted to Devil's

Den Water District in accordance with its long-term water supply contract. Therefore, only 29 agencies and districts now have long-term contracts with DWR as of December 31, 2007.

The contracts initially provided for a combined maximum annual Table A amount of 4,230,000 af of water supply. As a result of contract amendments in the 1980s and the Monterey Amendment, the current combined maximum annual Table A amount by 2016 totals 4,172,786 af. The contracts are in effect for the longest of the following periods:

- the project repayment period, which extends to the year 2035;
- 75 years from the date of the contract; or
- the period ending with the latest maturity date of any bond used to finance the construction costs of project facilities.

Figure 1-2 shows the name and location of each contracting agency and district and lists the first year of SWP delivery service for each. Table 1-6 presents more detailed information about each contracting agency.



**Figure 1-2 Names, Locations, and First Year of Service of Long-Term Contracting Agencies, December 31, 2007**

**Table 1-6 Long-Term Water Supply Contracting Agencies, by Area, as of December 31, 2007**

Contracting Agency	Cumulative Deliveries (af) <sup>a</sup>	Annual Table A (af)	Payments (Dollars)	Gross Area (Acres)	Assessed Valuation (Dollars) <sup>b</sup>	Estimated Population
<b>Upper Feather River Area</b>						
City of Yuba City	24,827	9,600	4,325,801	9,332	4,200,000,000	62,083
County of Butte	14,342	1,200	1,204,644	1,049,280	18,896,423,781	219,427
Plumas County Flood Control and WCD	10,472	720	1,529,127	1,676,056 <sup>c</sup>	2,060,744,342	21,200
<i>Subtotal</i>	<i>49,641</i>	<i>11,520</i>	<i>7,059,572</i>	<i>2,734,668</i>	<i>25,157,168,123</i>	<i>302,710</i>
<b>North Bay Area</b>						
Napa County Flood Control and WCD	234,096	22,875	78,324,445	510,010	25,242,440,033	135,500
Solano County Water Agency	626,962	47,356	108,371,983	537,600	47,700,000,000	424,823
<i>Subtotal</i>	<i>861,058</i>	<i>70,231</i>	<i>186,696,427</i>	<i>1,047,610</i>	<i>72,942,440,033</i>	<i>560,323</i>
<b>South Bay Area</b>						
Alameda County Flood Control and WCD–Zone 7	1,240,907	80,619	144,262,820	275,900	36,762,000,000	202,000
Alameda County WD	1,111,996	42,000	94,948,728	67,139	45,908,552,780	330,800
Santa Clara Valley WD	3,550,860	100,000	294,556,842	849,000	303,314,230,928	1,748,976
<i>Subtotal</i>	<i>5,903,763</i>	<i>222,619</i>	<i>533,768,390</i>	<i>1,192,039</i>	<i>385,984,783,708</i>	<i>2,281,776</i>
<b>San Joaquin Valley Area</b>						
County of Kings	118,509	9,305	5,623,307	893,300	8,170,055,752	151,381
Castaic Lake Water Agency	471,637	12,700	—	8,700	4,532,936	0
Dudley Ridge WD	2,115,395	57,343	71,820,684	37,600	85,400,000	36
Empire West Side Irrigation District	111,855	3,000	3,510,093	7,400	<sup>d</sup>	11
Kern County Water Agency	32,234,985	998,730	1,598,462,009	5,224,000	64,149,863,242	754,900
Oak Flat WD	195,941	5,700	5,687,051	4,500	<sup>d</sup>	10
Tulare Lake Basin Water Storage District	4,582,035	95,922	143,138,935	189,519	152,288,305	23
<i>Subtotal</i>	<i>39,830,357</i>	<i>1,182,700</i>	<i>1,828,242,078</i>	<i>6,365,019</i>	<i>72,562,140,235</i>	<i>906,361</i>
<b>Central Coastal Area</b>						
San Luis Obispo County Flood Control and WCD	41,888	25,000	62,753,468	2,122,240	37,363,525,861	260,727
Santa Barbara County Flood Control and WCD	248,309	45,486	400,447,650	1,775,296	49,196,921,210	421,625
<i>Subtotal</i>	<i>290,197</i>	<i>70,486</i>	<i>463,201,118</i>	<i>3,897,536</i>	<i>86,560,447,071</i>	<i>682,352</i>
<b>Southern California Area</b>						
Antelope Valley-East Kern Water Agency	1,641,669	141,400	399,549,509	1,525,547	25,685,000,000	365,000
Castaic Lake Water Agency <sup>e</sup>	705,909	82,500	231,573,480	124,800	27,070,976,711	249,600
Coachella Valley WD	920,751	121,100	238,616,444	639,857	57,138,070,411	350,879
Crestline-Lake Arrowhead Water Agency	47,829	5,800	22,340,762	55,100	1,500,527,807	25,000
Desert Water Agency	1,089,759	50,000	214,380,804	209,760	10,094,961,100	71,168
Littlerock Creek Irrigation District	18,995	2,300	5,608,856	10,000	438,155,825	2,900
Metropolitan WD of Southern California	29,026,337	1,911,500	8,185,268,479	3,314,080 <sup>f</sup>	1,998,260,031,413	18,365,245
Mojave Water Agency	268,751	75,800	203,872,984	3,136,000	28,464,178,622	433,000
Palmdale WD	211,364	21,300	59,815,214	119,680	1,470,701,596	109,845
San Bernardino Valley Municipal WD	638,471	102,600	437,380,255	224,000	28,115,559,357	600,000
San Gabriel Valley Municipal WD	329,131	28,800	123,023,167	18,297	11,720,110,333	210,145
San Geronio Pass Water Agency	9,936	8,650	80,546,232	140,800	507,540,188	65,500
Ventura County Watershed Protection District	45,805	20,000	48,749,302	308,252	22,701,024,063	460,000
<i>Subtotal</i>	<i>34,954,707</i>	<i>2,571,750</i>	<i>10,250,725,485</i>	<i>9,826,173</i>	<i>2,213,166,837,426</i>	<i>21,308,282</i>
<b>Total</b>	<b>81,889,723</b>	<b>4,129,306</b>	<b>13,269,693,070</b>	<b>25,063,045<sup>g</sup></b>	<b>2,856,373,816,596</b>	<b>26,041,804</b>

<sup>a</sup>All water delivered to long-term SWP contractors, including carryover, Article 21, surplus, unscheduled, exchange, permit, purchased, local, and non-SWP water.

<sup>b</sup>Statutes of 1978, Chapter 1207, added Section 135 to the Revenue and Taxation Code, requiring assessment at 100% of full value for the 1981–1982 fiscal year and fiscal years thereafter.

<sup>c</sup>Total of all Plumas County Flood Control and Water Conservation District, including Last Chance Creek Water District.

<sup>d</sup>Assessed valuation not available on an agency area breakdown.

<sup>e</sup>District includes land in the San Joaquin Valley Area formerly known as Devil's Den Water District.

<sup>f</sup>Total for Metropolitan, including Calleguas Municipal Water District, which is common to Metropolitan and Ventura County Watershed Protection District.

<sup>g</sup>Includes duplicate values. Some areas that are within two or more agencies are included in each agency's total.



## Chapter 2 Delta Resources

*General aerial of patterns in the Delta.*

## Significant Events in 2007

**T**he Department of Water Resources (DWR), in cooperation with federal and State agencies, completed a pilot salmon outmigration study in the North Delta.

DWR completed value engineering studies for the Franks Tract Project and the through-Delta facility.

The Governor issued a list of immediate and interim actions to be included as part of a comprehensive water package to improve Delta conditions.

The Delta Vision Blue Ribbon Task Force was appointed by the Governor in February 2007. The final vision document, "Our Vision for California's Delta," was adopted November 30, 2007.

In spring 2007, the State saw the first voluntary shutdown of the State Water Project (SWP) pumps in the Delta to protect fish.

In December 2007, a federal court imposed interim rules that significantly restrict the operations of both the SWP and the Central Valley Project (CVP) while a new biological opinion for Delta smelt is written in 2008.

Decker Island Habitat Restoration Area, completed in 2007, is targeted specifically for the needs of endangered Sacramento splittail and delta smelt, providing 26 acres of tidal aquatic area.

The charter for the multiagency Delta Long-Term Management Strategy for the beneficial reuse of dredged material became effective in February 2007.

*Information for this chapter was contributed by the FloodSAFE Environmental Stewardship and Statewide Resources Office, the Bay-Delta Office, and the Division of Flood Management.*



The Sacramento-San Joaquin Delta is a unique environmental resource and a major source of water for millions of Californians. Over the past 40 years, the Department of Water Resources (DWR), and other State and federal agencies, have developed and implemented numerous programs to manage the Delta.

DWR's water management programs focus on solving problems in three areas of the Sacramento-San Joaquin Delta: the North Delta, West Delta, and South Delta (see Figure 2-1).

These programs share the following common goals:

- improve water supply reliability to the State Water Project (SWP), Central Valley Project (CVP), and Delta water users;
- determine levels of flow and salinity necessary to protect fish and wildlife habitat;
- devise methods to control flooding;
- protect fish and wildlife; and
- provide recreational activities.

## Delta Water Management Programs

Future water deliveries to millions of Californians throughout the state will be affected by many factors, including two significant changes: Delta pumping restrictions and climate change. The first stage of the CALFED Bay-Delta Program (CALFED Stage 1), implemented from 2000 through 2007, focused on conveying water supply through the Delta. Specific projects and studies were undertaken during CALFED Stage 1 to determine the feasibility of a through-Delta approach.

In spring 2007, the State saw the first voluntary shutdown of the SWP pumps in the Delta to protect fish. Limited pumping resumed 10 days later, and 5 days after that, pumping was increased to resume water deliveries.

Unfortunately, these actions did not result in an increase in the abundance of delta smelt in fall 2007, suggesting that more than just water project operational changes in the Delta are needed to increase delta smelt abundance. In December 2007, a federal court imposed interim rules that would significantly restrict the operations of both the SWP and the CVP while a new Operations Criteria and Plan (OCAP) biological opinion (BO) for delta smelt was being written in 2008.

During 2007, new Delta planning efforts—including Delta Vision established by the Governor and the Bay Delta Conservation Plan (BDCP) process—reached important conclusions about the need to change the way water is conveyed across or around the Delta to better protect fish and provide a sustainable and reliable water supply for the State.

Four major concurrent Delta planning efforts are under way with objectives related to providing a sustainable Delta: Delta Vision, Delta Risk Management Strategy (DRMS), the CALFED Ecosystem Restoration Program (ERP) Conservation Strategy, and BDCP.

### Delta Vision

On September 28, 2006, in conjunction with the signing of Senate Bill (SB) 1574, the Governor signed an executive order to initiate Delta Vision and establish an independent Blue Ribbon Task Force to develop a durable vision for sustainable management of the Sacramento-San Joaquin Delta. Executive Order S-17-06 directs the Delta Vision Committee to complete the vision by January 1, 2008 and a strategic plan by November 2008. The Delta Vision process

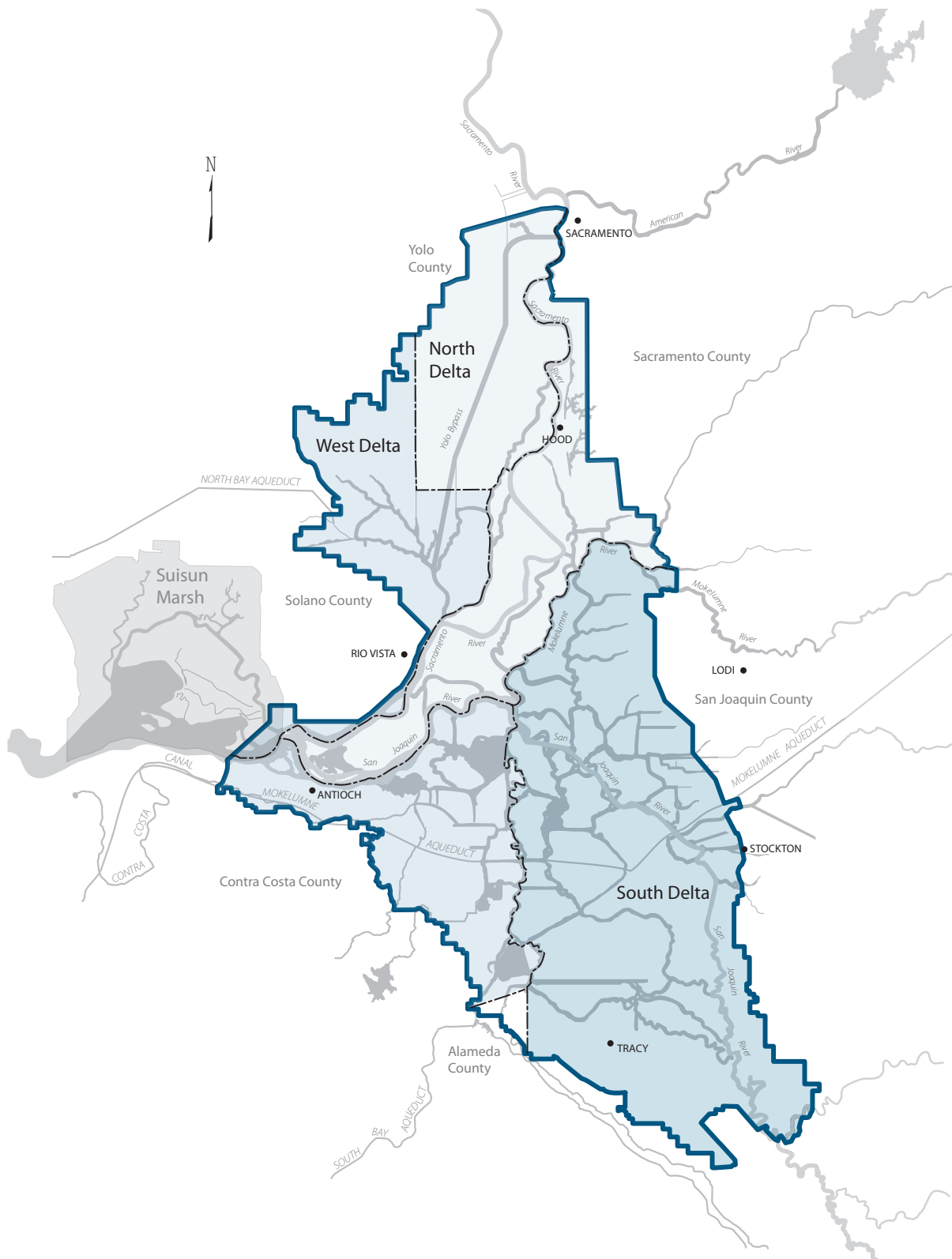


Figure 2-1 The North, West, and South Delta as Defined in Public Resources Code Section 29735

will look more broadly at the sustainability of the Delta.

The Delta Vision Blue Ribbon Task Force was appointed by the Governor in February 2007 and met frequently throughout the year in public meetings to receive public and scientific input on how the Delta issues must be addressed. After many meetings, the Task Force issued three successive refined drafts of “Our Vision for California’s Delta.” The third draft included 12 interrelated recommendations and several near-term actions to protect the Delta. The vision document was adopted November 30, 2007 and released December 17, 2007. For more information visit the Delta Vision website at: <http://deltavision.ca.gov/index.shtml>.

## Delta Risk Management Strategy

The 2000 CALFED record of decision (ROD) presented its Preferred Program Alternative describing actions, studies, and conditional decisions to help resolve issues in the Delta. Included in the CALFED Stage 1 implementation of the preferred alternative was completion of a Delta Risk Management Strategy (DRMS) that would look at sustainability of the Delta and assess major risks to Delta resources from floods, seepage, subsidence, and earthquakes. DRMS would also evaluate the consequences and develop recommendations to manage the risk.

The DRMS preliminary findings have been reviewed by a CALFED scientific panel. The review has led to a reevaluation of some of the initial DRMS analyses. Results of the reevaluation will be incorporated into the final report, to be completed in April 2008. Delta Vision, the CALFED ERP, and BDCP depend on the best available information from DRMS to support their own processes. DRMS is a source of scientific and technical information on the Delta and Suisun Marsh levees for other studies and initiatives such as Delta Vision, BDCP, and the CALFED end of Stage 1 assessment.

## CALFED Ecosystem Restoration Program Conservation Strategy

The CALFED Ecosystem Restoration Program (ERP) Conservation Strategy (CS) is a biological view of where restoration of important habitat types could occur to restore ecosystem form and processes to the maximum extent. The CS is also incorporating information from other Delta-related planning efforts (e.g., DRMS, Suisun Marsh Implementation Plan, CALFED ERP end of Stage 1 assessment, and recovery plans for federally-listed species) and technical and public input.

## Bay Delta Conservation Plan

BDCP has a different and more specific purpose than do DRMS and Delta Vision.

BDCP is being developed as a joint federal Habitat Conservation Plan and State Natural Community Conservation Plan. The purpose of BDCP is to promote the recovery of sensitive species and their habitats in the Delta in a way that also will provide for the protection and reliability of water supplies. Among other things, the plan will provide:

1. a comprehensive habitat conservation and restoration program for the Delta and
2. the basis for permits under federal and State endangered species laws for the activities covered by the plan, based on the best available science.

The BDCP steering committee has been working since April 2007 to evaluate different conceptual approaches to the development of the BDCP. After considering a wide variety of potential strategy options, 10 conservation strategies were analyzed based on biological, planning, and other criteria, then narrowed to four conservation options to be evaluated in detail. See the BDCP sidebar for a description of the four options.

The BDCP effort produced a series of technical papers on the merits of different concepts in Delta water conveyance. By the end of 2007 the concept of dual conveyance seemed to be widely agreed

upon to help reliably convey water for export while providing a level of protection for native Delta fish and water quality for Delta farmers.

### **Bay Delta Conservation Plan Proposed Conservation Strategy Options**

BDCP conservation measures are those actions that, collectively, are expected to achieve the BDCP biological goals and objectives. Conservation measures address conveyance and water operations; protection, enhancement, and restoration of physical habitats that support covered species; and reductions in the effect of other stressors on covered species. The BDCP Conservation Strategy (CS) proposes two types of water operations conservation measures: (1) construction of new operational control facilities and (2) operations of new operational control facilities or changes to the operations of existing operational control facilities.

The CS Workgroup developed four CS options based on existing scientific information about environmental stressors affecting covered fish species and Delta ecosystem processes. The CS Workgroup recommended these options to the Steering Committee for approval to further evaluate their feasibility and effectiveness in conserving the covered species and other components of the ecosystem.

**Option 1: Existing through-Delta conveyance.** This option includes use of existing through-Delta conveyance with physical habitat restoration in the North and West Delta and Suisun Marsh (approximately 28 percent of the BDCP planning area).

**Option 2: Improved through-Delta conveyance.** This option includes improving through-Delta conveyance with operable barriers on some channels, separating water supply conveyance flows from the San Joaquin River, and providing habitat restoration in the North, West, Central, and South Delta and Suisun Marsh (approximately 35 percent of the BDCP planning area).

**Option 3: Dual conveyance.** This option is similar to Option 2 with the addition of an isolated conveyance facility from the Sacramento River to the South Delta export facilities.

**Option 4: Isolated facility.** This option includes construction of an aqueduct from the Sacramento River to the South Delta export facilities, which would allow habitat restoration throughout the Delta and Suisun Marsh (approximately 75 percent of the BDCP planning area).

For more information, visit the BDCP website at:  
<http://baydeltaconservationplan.com>.

## North Delta Program

Since 2003, DWR has been involved in evaluating several proposed modifications included in the CALFED ROD. These modifications include changes in the North Delta's conveyance facilities to improve Delta water quality, fisheries, and water supply reliability, as well as modifications to improve flood protection and ecosystem health.

CALFED North Delta actions include:

- evaluation and implementation of improved operational procedures for the Delta Cross Channel (DCC) to address fishery and water quality concerns;
- evaluation of a screened through-Delta facility (TDF) on the Sacramento River of up to 4,000 cubic feet per second (cfs);
- evaluation of flow and salinity in Franks Tract to improve fish protection and improve water quality through installation of operable barriers in the Franks Tract region; and
- design and construction of floodway improvements to provide conveyance, flood control, and ecosystem health (North Delta Flood Control and Ecosystem Restoration Project).

In 2007, DWR, in cooperation with federal and State agencies, completed the field work and data processing of a pilot salmon outmigration study. This pilot study was conducted to assess the feasibility for the comprehensive Delta Regional Salmon Outmigration Study. DWR conducted water quality modeling analyses and prepared conceptual design layouts for alternatives considered for the Franks Tract Project and the TDF. To evaluate the alternatives, DWR conducted value engineering studies for both the Franks Tract Project and TDF. Reclamation, through its North/Central Delta Improvement Study (NoCDIS), is evaluating the feasibility of using conveyance and operations actions in the north and central

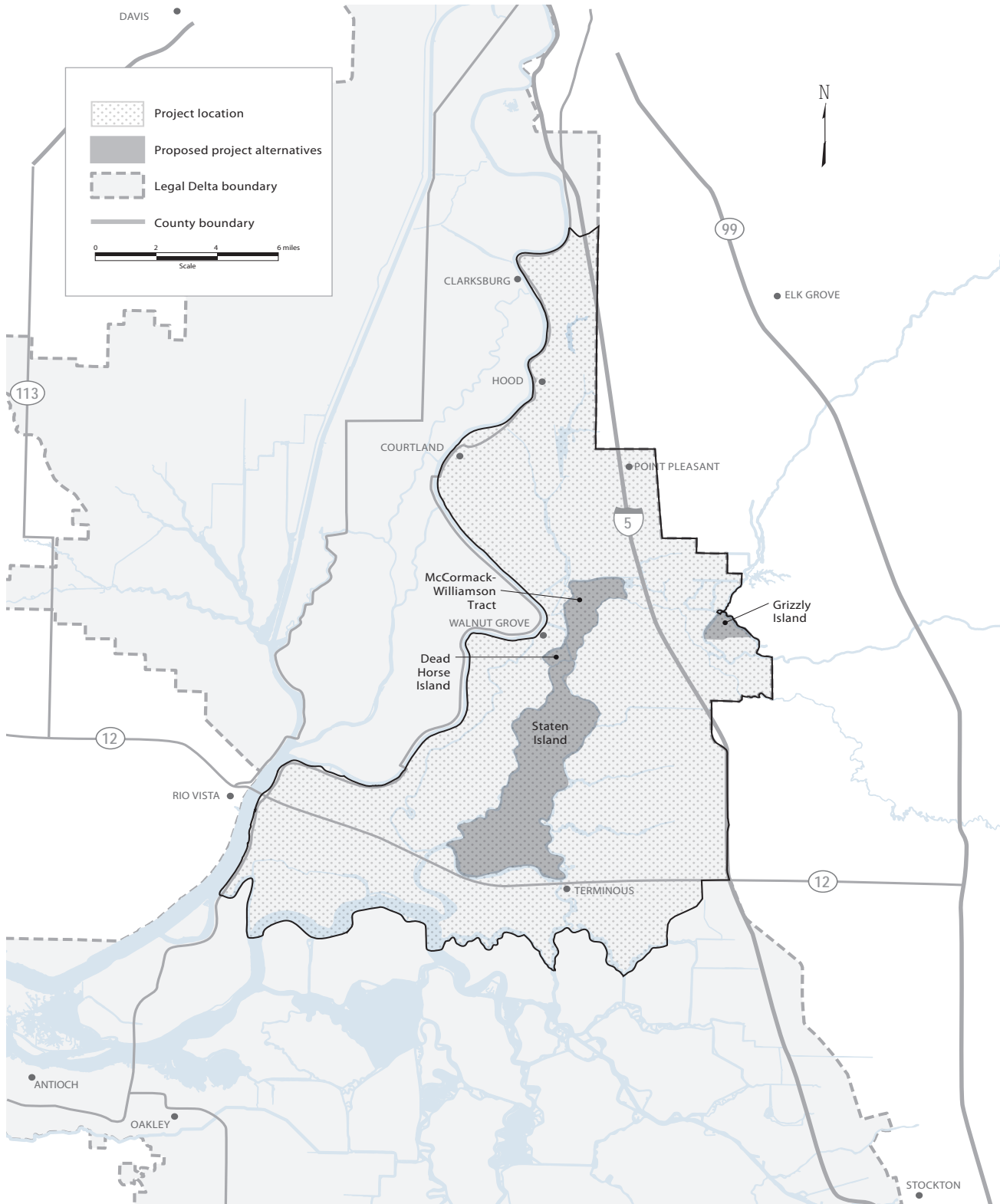
region of the Sacramento–San Joaquin River Delta near Franks Tract to improve water quality and fish conditions. In addition to DWR's evaluation of alternatives, Reclamation's NoCDIS plan of study (August 2007) considers other additional alternatives in the north and central Delta. These efforts were in support of the assessments required under CALFED to address concerns over water quality impacts from DCC operations, technical viability of a TDF, and resolution of fisheries concerns about a TDF. The *Delta Conveyance Improvement Studies Summary Report*, released by DWR in December 2007, presents key findings for cooperative CALFED Stage 1 studies to evaluate Franks Tract, TDF, and DCC reoperation project actions. In addition, this report describes continuing and planned project studies.

More information and study reports are available on the DWR Bay-Delta Office website: <http://baydeltaoffice.water.ca.gov>.

## North Delta Flood Control and Ecosystem Restoration Project

North Delta Flood Control and Ecosystem Restoration improvements, a CALFED Stage 1 action, provides flood control and ecosystem restoration in the North Delta. These improvements support other CALFED goals, which include water supply reliability, recreation, and agricultural land preservation. DWR is the State implementing agency, and many of the proposed CALFED elements for the project are similar to elements of earlier North Delta planning efforts. These earlier projects were suspended in deference to the CALFED program.

**Project Area.** The project area (Figure 2-2) is approximately 197 square miles where DWR is considering alternatives for flood control and restoration actions. The following criteria were used to develop project area boundaries.



**Figure 2-2 North Delta Flood Control and Ecosystem Restoration Project, Project Area**

- The project area must include the footprint area of each alternative.
- The project area should be hydrologically contiguous.
- The project area should include portions of all waterways where existing flow patterns could be substantially affected by one or more of the alternatives.
- The project area should be compatible with flood control planning and implementation responsibilities of other flood control agencies.

**Project Status.** During 2007, DWR continued overseeing preparation of the public draft EIR. With assistance from consultants, DWR developed responses to comments received on the administrative draft EIR and completed the public draft EIR in November 2007. The draft EIR is available on the project website.

Proposed project actions and alternatives are subdivided into two basic groups for analysis in the EIR.

Group I consists of modifications to levees on McCormack-Williamson Tract, downstream levee raising to offset potential hydraulic impacts caused by these modifications, restoration of McCormack-Williamson Tract and the Grizzly Slough property, and dredging of the Mokelumne River.

Group II consists of proposed project actions on Staten Island and levee modifications and dredging along the Mokelumne River.

DWR staff worked with federal regulatory agency scientists and academic experts to complete development of three ecological conceptual model alternatives for the Group I actions. Details of the conceptual models are in Appendix D of the public draft EIR.

A preferred project alternative will be chosen through the EIR process and will be identified in the final EIR.

Key schedule milestones completed during 2006 and 2007 include the completion of the administrative and public drafts of the EIR.

For more information, visit the North Delta Flood Control and Ecosystem Restoration Project website at:

<http://www.water.ca.gov/floodmgmt/dsmo/sab/ndp>.

## West Delta Program

Objectives of the West Delta Program include the following:

- effectively manage SWP-owned lands on Sherman and Twitchell islands (approximately 13,000 acres total);
- improve the integrity of local levees;
- implement land-use management techniques to control subsidence and soil erosion on Sherman and Twitchell islands; and
- provide diverse habitat for wildlife, especially waterfowl.

DWR is a major landowner on Twitchell and Sherman islands and holds two of the three trustee positions for Reclamation Districts 1601 (Twitchell Island) and 341 (Sherman Island). Consequently, DWR participates in the management and operation of each district, with the goal of improving conditions and accountability. The reclamation districts provide levee maintenance, island drainage, and some internal water supply. These districts assess the landowners for the operational needs of the public districts.

## South Delta Improvements Program

During the late 1990s, DWR pursued the Interim South Delta Program (ISDP), intending to accelerate construction of South Delta facilities to improve Delta water conditions. During the same period, the CALFED Bay-Delta Program worked on an independent long-term solution. DWR

released a draft EIS/EIR for ISDP in July 1996; however, a final EIS/EIR was never produced. In 1999, the South Delta facilities became a key component of the CALFED Bay-Delta Program. Subsequently, ISDP was renamed the South Delta Improvements Program (SDIP), and additional program objectives and purposes, as described below, were added.

DWR and Reclamation suspended most planning and permitting activities during 2007 because the Endangered Species Act (ESA) consultation for the OCAP needs to be completed for the program to move forward. Reclamation and DWR worked together to prepare the biological assessment required to enter into formal consultation.

The SDIP consists of physical/structural and operational components. SDIP Stage 1, the physical/structural component, would consist of constructing and utilizing permanent operable gates and conveyance dredging. The SDIP Stage 2 operational component would consist of changes in export regulations, allowing an increase in water deliveries and delivery reliability for SWP and CVP water contractors.

DWR and Reclamation identified the following project objectives and purposes for SDIP:

- reduce the movement of San Joaquin River watershed Central Valley fall-run and late fall-run juvenile Chinook salmon into the South Delta via Old River (SDIP Stage 1);
- maintain adequate water levels and water quality through improved circulation for agricultural diversions in the South Delta, downstream of the Head of Old River (SDIP Stage 1);
- increase water deliveries and delivery reliability to SWP and CVP water contractors south of the Delta (SDIP Stage 2); and

- provide opportunities to convey water for fish and wildlife purposes by increasing the maximum permitted level of diversion through the existing intake gates at Clifton Court Forebay to 8,500 cfs (SDIP Stage 2).

Because of the decline in abundance indices for pelagic organisms and until more is known about the effects of SDIP Stage 2 on delta smelt and other protected fish species, DWR is recommending that only SDIP Stage 1 actions be completed now, thus deferring SDIP Stage 2.

The SDIP Stage 1 physical/structural component consists of the following elements:

- construct and operate a fish-control gate at the Head of Old River to reduce the downstream movement of San Joaquin River watershed Central Valley fall-run and late fall-run juvenile Chinook salmon into the South Delta via the Head of Old River;
- construct and operate up to three flow-control structures (gates) at Middle River (near the confluence of Middle River with Victoria Canal), Grant Line Canal (near the confluence of Grant Line Canal and Old River), and Old River (just east of the Delta-Mendota Canal Intake) to improve existing water level and circulation patterns in South Delta water channels;
- dredge various channels in the South Delta, including Middle and Old rivers, to improve conveyance and dredge areas surrounding agricultural diversions to improve their function; and
- extend up to 24 agricultural diversion intake facilities to improve their function.

SDIP elements originally placed in the ROD included increasing diversions through Clifton Court Forebay (first to 8,500 cfs and then to 10,300 cfs), dredging and installing operable tidal barriers in the South Delta,



installing a fish barrier at Head of Old River, and constructing the first phase of a new intake and fish screen into Clifton Court Forebay. DWR deferred the increase in diversions of up to 10,300 cfs and the associated new fish screens as components of the SDIP due to major funding issues, as well as significant technical uncertainties associated with the design and construction of the new fish screens.

On February 15, 2006, the State Water Resources Control Board (SWRCB) issued a Cease and Desist Order (Order WR 2006-0006) requiring DWR and Reclamation to construct permanent gates in the South Delta or take alternative measures for achieving the water quality objectives by 2009. Additionally, the order requires DWR and Reclamation to report to SWRCB if there is a threat of noncompliance of the water quality requirements, and to report the reasons for the noncompliance and actions taken to avoid noncompliance. SWRCB will then determine if enforcement actions are necessary. DWR must also submit quarterly progress reports on the permitting and construction of SDIP Stage 1.

### **Preferred Plan**

The preferred plan for SDIP is to construct the physical/structural component as soon as permits are obtained and defer the operational component until more is known about the project's potential effects on the delta smelt and other protected fish species.

### **Temporary Barrier Facilities**

Temporary rock barriers will continue to be installed annually, during low flow conditions, until the four proposed permanent gates are operational. The barriers are installed at four sites (see Figure 2-3), as follows.

1. Head of Old River, in Old River where it splits from the San Joaquin River;
2. Old River near Tracy, one-half mile east of the Jones Pumping Plant intake and about 8 miles northwest of Tracy;
3. Middle River, just south of the confluence of Middle River, Trapper Slough, and North Canal; and
4. Grant Line Canal, 420 feet east of the Tracy Boulevard Bridge.

The Head of Old River barrier prevents the San Joaquin River flow from entering Old River and flowing toward export facilities. This additional flow in the San Joaquin River helps guide San Joaquin salmon to the ocean in the spring and improves dissolved oxygen levels for upstream salmon migration in the fall. The other barriers have culverts with flap gates that improve water levels and circulation in South Delta channels during the irrigation season.

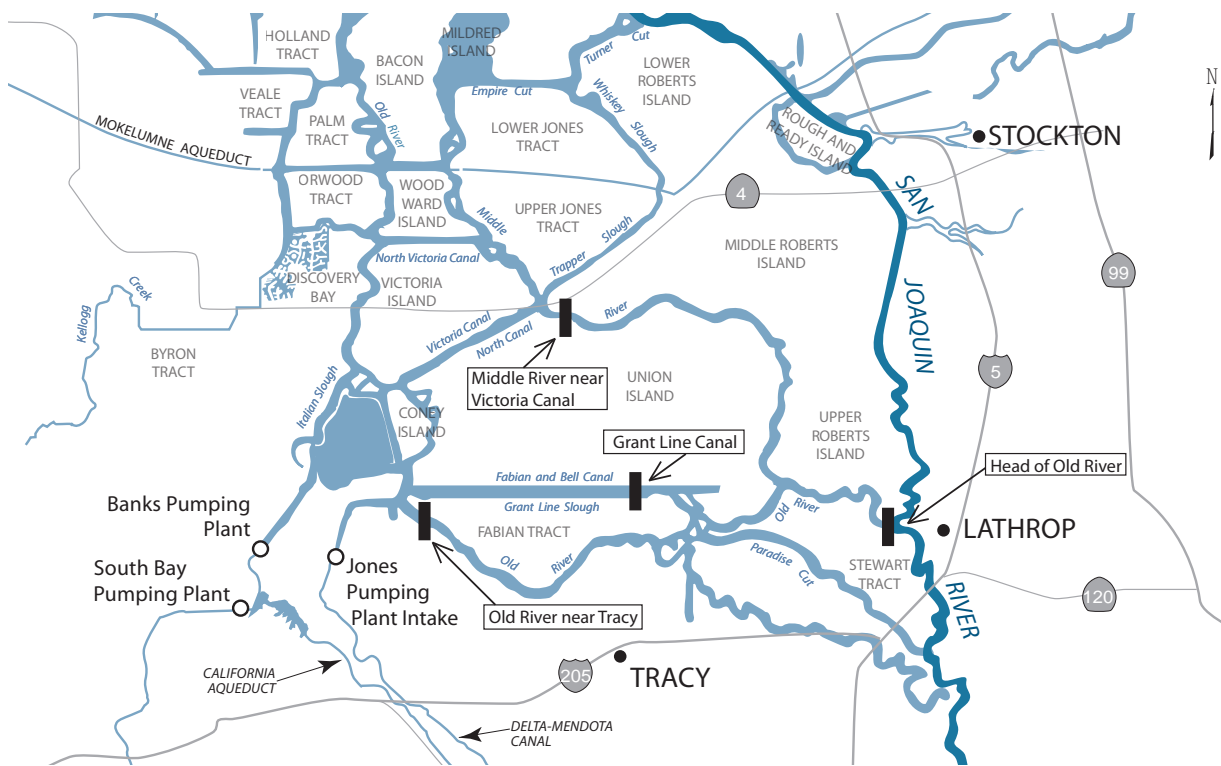
Since 1963, the Head of Old River barrier has been installed in the fall. Since 1992, this barrier has also been installed intermittently in the spring, although high San Joaquin River flows sometimes prevent installation. The Old River barrier near Tracy has been seasonally installed since 1991; the Middle River barrier has been seasonally installed since 1987; and the Grant Line Canal barrier has been seasonally installed since 1996.

### **Other South Delta Actions**

Besides SDIP, actions in the South Delta include implementing flood and ecosystem improvements in the lower San Joaquin River and pursuing construction of potential interties between the SWP California Aqueduct and CVP Delta-Mendota Canal.

## **Delta Flood Control**

Many important assets in the Sacramento-San Joaquin Delta are protected from flooding by levees. Without the levees, much of Delta as we know it today would be an inland sea. The levees serve many needs. They protect valuable wildlife habitat,



**Figure 2-3 Temporary Barrier Locations**

farms, homes, urban areas, recreational developments, highways, railroads, natural gas fields, utility lines, a major aqueduct, and other public developments. They are critical to the protection of in-Delta water quality and water quality for approximately 25 million Californians who receive a portion of their water from the Delta. The State Legislature recognized the importance of the Delta and enacted the Delta Flood Protection Act of 1988 (SB 34 [Water Code Sections 12300 et seq., and 12980 et seq.]). With SB 34, the Legislature declared that “. . . the Delta is endowed with many invaluable and unique resources and that these resources are of major statewide significance.”

Since 1988, the Delta Levees Program has managed approximately \$234 million in State-appropriated funds. These monies, combined with local funds, have realized approximately \$305 million in

levee improvements (through State Fiscal Year 2006–2007).

In SB 34, the Legislature declared its intent to appropriate \$12 million annually for the Delta Flood Protection Fund. Six million dollars of the appropriation is for local assistance under the Delta Levee Maintenance Subventions Program. The remaining \$6 million is for the Delta Levees Special Flood Control Projects, including subsidence studies and monitoring on Bethel, Bradford, Jersey, Sherman, and Twitchell islands; Holland, Hotchkiss, and Webb tracts; and the towns of Thornton and Walnut Grove.

In 1996, Assembly Bill (AB) 360 was signed into law, expanding the area covered by the Delta Levees Program to include the remainder of the legal Delta and northern Suisun Bay from Van Sickle Island to Montezuma Slough.

Bond appropriations of \$25 million from Proposition 204 (enacted in 1996) and \$30 million from Proposition 13 (enacted in 2000) provide supplemental funding.

In November 2002, Proposition 50 was approved. It provides \$70 million in additional funding to implement the Delta Flood Protection Program as adopted in CALFED, where the program is known as the Levee System Integrity Program (LSIP).

Proposition 84, approved by voters in November 2006, allocates \$275 million to the Delta over the next four years.

Proposition 1E, also approved by voters in November 2006, adds funding for Delta levee improvements.

## **CALFED Levee System Integrity Program**

CALFED LSIP goals and objectives are described below.

### ***Base Level Protection***

According to the CALFED ROD, all Delta levees should be built to the U.S. Army Corps of Engineers (Corps) Delta-specific levee standard (Public Law [PL] 84-99). This standard provides protection against flooding in a 100-year flood event. The minimum freeboard is 1.5 feet for levees protecting agricultural land. A typical improved levee section would have a 16-foot crown width, a waterside slope of 2 horizontal to 1 vertical, and a landside slope designed for the depth of peat soils under the levee. Generally, the landside slope would be between 3:1 and 5:1.

This program provides funding to help local levee maintaining agencies improve all Delta levees to the PL 84-99 standard. About 500 out of 1,100 miles of Delta levees, including approximately 400 miles of project levees, are at or above the PL 84-99 standard.

During CALFED Stage 1 (implemented 2000–2007), about 200 additional miles of levees were planned to be brought up to the PL 84-99 level of protection, provided there is sufficient funding. Additional Proposition 84 funds became available to the Delta Levee Maintenance Subventions Program in Fiscal Year 2006–2007.

### ***Levee Upgrades***

Upgrading the Delta levees is an integral part of the CALFED LSIP plan being implemented through the DWR Delta Flood Protection Program.

DWR and the Corps signed an agreement in 2001 to co-manage the CALFED LSIP, including the Delta Flood Protection Program. This agreement allows close coordination of efforts and assures compatibility with CALFED goals and objectives.

Levee improvements beyond the PL 84-99 standard, where appropriate, will follow or complement the completion of base level protection depending on continuation of the program and funding availability. Results from DRMS will enable DWR to prioritize future work.

### ***Special Improvement Projects***

This program will enhance levee stability by raising the levee crest above the PL 84-99 standard. This work will be completed on levees that have particular importance in the State. Priorities include protecting life and personal property (more than 400,000 people live in Delta towns and cities); water quality (preventing salinity intrusion); the Delta ecosystem; and agricultural production. No projects were been completed in 2007, as available funding was used toward the backlog of deficient levee sections.

### ***Suisun Marsh Flood Protection and Ecosystem Enhancement***

This program provides levee integrity, ecosystem restoration, and water quality benefits by supporting maintenance and improvement of the levee system in the Suisun Marsh. The Suisun Marsh Levee Investigation was undertaken in January 1999, at the request of the CALFED Policy Group, to determine whether adding Suisun Marsh levees into the LSIP would contribute to CALFED program goals. The team identified significant links between Suisun Marsh levee maintenance and achievement of CALFED drinking water quality and ecosystem restoration goals. Furthermore, modeling research indicates a significant risk of negative water quality impacts in the Delta if Suisun Marsh levees are inadequately maintained and allowed to fail.

CALFED LSIP actions for the Suisun Marsh will be developed during preparation of the Suisun Marsh Plan. Full implementation of the Suisun Marsh portion of LSIP awaits completion of the Suisun Marsh Charter, independent funding, and authority in the Water Code, or other law, for the program authorization.

### ***Delta Flood Emergency Preparedness and Response Plan***

DWR is currently developing a Delta Flood Emergency Preparedness and Response Plan to improve its ability to prepare for, respond to, and recover from multiple-island levee failure within the Sacramento-San Joaquin Delta caused by a flood or seismic event. The plan objective is to minimize recovery time from such an event through preparedness, response, and actions taken.

### ***Delta Levee Maintenance Subventions Program***

The Delta Levee Maintenance Subventions Program provides funds to provide up to 75 percent of the eligible costs of levee

maintenance for levee work critical to the long-term survival of Delta islands, State and private infrastructure, and the State water supply. This program assures continuance of the Delta's ability to provide its many statewide and local benefits. Within CALFED's LSIP, the Delta Levee Maintenance Subventions Program provides funding, as a reimbursement, to local Delta reclamation districts for levee maintenance and improvement.

Each year, up to 70 participating local agencies prepare work plans and file funding applications with the Central Valley Flood Protection Board (CVFPB). The applications and work plans are reviewed by DWR, which then makes recommendations and requests CVFPB approval for the program funding levels. CVFPB approves each district's maximum possible reimbursement and maximum advanced reimbursement amounts. After CVFPB approval, agreements are executed between CVFPB and each participating district. These agreements state that eligible work will be completed during the current fiscal year. All work must be in compliance with appropriate State and federal laws, including the California Environmental Quality Act (CEQA), ESA and California Endangered Species Act (CESA), Section 1600 of the Fish and Game Code, and Section 404 of the Clean Water Act, and must have confirmation from the Department of Fish and Game (DFG) that a net long-term habitat improvement of riparian, fisheries, and wildlife habitat will result.

### ***Delta Levees Habitat Improvement***

As part of the CALFED LSIP, the FloodSafe Environmental Stewardship and Statewide Resources Office continues to move forward in creating valuable habitat in the Delta. By the end of 2007, the program had developed 283.7 acres of various types of habitat, 9,410 linear feet of shaded riverine aquatic habitat for mitigation, and 24.4 acres and 14,328 linear feet of shaded riverine aquatic for enhancement.

Completed mitigation and enhancement projects include the following:

- Medford, Bethel, and Kimball islands;
- Terminous, Wright Elmwood, Palm, and Thornton-New Hope (Grizzly Slough) tracts;
- Twitchell Island setback levee;
- Twitchell Island mitigation areas;
- Staten Island berm and channel islands;
- Canal Ranch attached berm;
- lower Sacramento River revegetation, Grand Island, in participation with the Corps;
- Decker Island Phase I and Phase II construction and tidal wetlands restoration at Horseshoe Bend along the lower Sacramento River;
- Tyler Island bank stabilization demonstration; and
- Delta In-Channel Demonstration Project.

The Delta In-Channel Demonstration Project was undertaken with support from CALFED to determine the feasibility of “environmentally friendly” structures for controlling erosion and protecting Delta habitat associated with in-channel islands. The three in-channel island test sites were Webb Tract Sites I and III and Little Tinsley Island. The project demonstrated the feasibility of protection and restoration of Delta priority landforms and populations of special-status species using environmentally friendly biotechnical treatments.

Other projects underway include the following:

- long-term management of Meins Landing for conversion to tidal marsh and enhancement of salt marsh harvest mouse habitat;
- bird monitoring at the Decker Island restoration site;
- construction of a setback levee on Sherman Island;

- Sherman Island Parcel 11 Revegetation Project;
- Dutch Slough tidal marsh restoration; and
- Bradford Island Tract 19 mitigation area monitoring and maintenance.

Proposed projects include Delta levees habitat mitigation, flooded islands, McCormack-Williamson Tract, Elk Slough, and Veale Tract.

DWR, DFG, and reclamation districts are successfully providing avoidance or mitigation of habitat losses and net long-term habitat improvement in the Delta. Reclamation districts have been very cooperative in helping DWR meet its mitigation and enhancement needs. Decker Island Habitat Restoration Area, completed in 2007, is targeted specifically for the needs of endangered Sacramento splittail and delta smelt, providing 26 acres of tidal aquatic area. Continued monitoring is determining the amount of fishery and avian use of the restoration site, evaluating the hydrogeomorphic performance of the site, and providing valuable data for future restoration work.

DWR and DFG will continue to work with the reclamation districts to preserve existing habitat and improve the quantity and quality of newly developed habitat in the Delta.

## Delta Special Flood Control Projects Program

The Delta Special Flood Control Projects Program under CALFED assists the eight western islands, portions of the Suisun Marsh, the towns of Thornton and Walnut Grove, and other locations in the Delta with flood protection and levee stability repairs. The California Water Commission approved a report of initial actions in September 1989, and it approved the long-term actions and priorities in May 1990. The long-term actions and priorities serve as a guide for DWR to determine how best to use appropriations to

protect these islands. Long-term actions and priorities include the following:

- rehabilitation of threatened levees through the use of imported dredged material;
- verification of elevations in the Delta through the use of global positioning system (GPS) equipment and light detection and ranging (LiDAR);
- upgrading levees to the standards included in Bulletin 192-82; and
- considering projects to achieve net long-term habitat improvement for fish and wildlife.

While DWR seeks cost sharing for all projects, the actual reimbursement depends on each reclamation district's ability to pay. DWR provides up to 100 percent of the cost. Districts receiving these funds are required to participate in a habitat improvement program to ensure net long-term habitat enhancement.

Levee restoration projects, habitat projects, and other special projects in 2007 included work performed on the western Delta islands and New Hope Tract.

## Reuse of Dredged Material for Delta Levees

As local sources of fill material for levee repair are depleted, new economical sources must be located. DWR has worked to find more opportunities to reuse clean, dredged materials in the Sacramento-San Joaquin Delta.

As part of this effort, a charter for the multiagency Delta Long-Term Management Strategy (LTMS) for the beneficial reuse of dredged material became effective in February 2007. The LTMS is designed to improve operational efficiency and coordination of the collective and individual agency decision-making responsibilities, resulting in approved dredging and dredged material management actions in

the Delta. Regular LTMS meetings include representatives from DWR, the Corps, the U.S. Environmental Protection Agency, the Regional Water Quality Control Board (RWQCB), the ports of Stockton and Sacramento, and other interested parties. LTMS is evaluating potential beneficial reuse opportunities, particularly from the proposed Sacramento and Stockton Deep Water Ship Channel projects, and has prepared a draft summary of Delta dredged material placement sites and a draft Delta-wide map of existing sediment placement sites.

To facilitate the permitting process for dredging and dredged material placement and reuse, a draft joint permit application for dredging and dredged material placement/reuse has been developed, an interagency agreement between DWR and RWQCB is underway, a sediment background study is being planned, and development of general order Waste Discharge Requirements to help streamline RWQCB's approval process has been initiated.

LTMS long-term goals include the following:

- developing a streamlined permitting process for dredging and dredged material reuse;
- developing a consolidated guidance document addressing sampling, tests, protocols, and methods for assessing sediment and dredged material characterization;
- developing a sediment management plan designed to help anyone who wants a better understanding of methodologies for assessing and characterizing sediments and determining appropriate disposal options;
- developing a programmatic biological assessment for sensitive Delta species;
- drafting a programmatic EIR/EIS for the Delta LTMS; and
- identifying and permitting additional sediment placement and beneficial reuse sites in the Delta.

For more information, visit the LTMS website: <http://www.deltaltms.com>.

## Subsidence Investigations

Historically, draining and cultivating Sacramento-San Joaquin Delta marshlands caused the peat soil to break down and compact. The peat has oxidized and subsided since the mid-1800s when the land was first drained and levees constructed. The surface of organic soils in the Delta is now between 10 and 29 feet below sea level. The Legislature recognized the problem and, with the initiation of the Delta Flood Protection Act of 1988, DWR began monitoring subsidence and studying its causes and the means for reversing its effects.

DWR and the U.S. Geological Survey (USGS) are conducting an ongoing subsidence investigation in the Delta. Preliminary data indicate the following:

- land management practices substantially influence subsidence rates;
- cultivation practices that raise soil temperature and lower the water table dramatically increase oxidation of the peat soils;
- conversion of highly organic peat soils to carbon dioxide gas (oxidation) appears to be the recent primary cause of subsidence;
- permanently flooded shallow wetlands decrease release of gaseous carbon by as much as 80 percent, thereby mitigating subsidence; and
- permanently flooded shallow wetlands also promote the growth of wetland vegetation that adds biomass back into the system.

Current studies of subsidence mitigation and growth of wetland vegetation suggest that shallow permanent flooding will be part of the process to reverse subsidence through biomass accretion.

A Farm Scale Wetlands Demonstration Project has been proposed for 2008. It would be located adjacent to the existing Subsidence Reversal Demonstration Project and is intended to determine the land accretion and carbon sequestration rates associated with wetland farming within the western Delta. The rationale for this study stems from work performed since 1997 at the Twitchell Wetlands Research Facility. This research has shown that wetland restoration can accrete a net average of 2 inches of land surface per year and potentially sequester 25 tons of carbon per acre per year. Implementation of the wetlands demonstration project includes construction of a farm scale wetland, between 300 and 1,000 acres, within the western Delta.

In addition to tules, rice is a wetland crop with an existing agricultural market that has the potential to accrete land mass and sequester carbon. The Subsidence Mitigation Through Rice Cultivation Research project will determine whether growing rice reverses subsidence without deleterious effects to the environment and is economically feasible in the Delta. The project area is a 320-acre parcel on Twitchell Island and is planned to operate for 6 years (2008 through 2013).

DWR continues to work with the CALFED Science Program to develop best management practices to control and reverse subsidence and will work with local districts and landowners to implement cost-effective measures.

For current information related to these projects, please visit [http://www.water.ca.gov/floodsafe/fessro/levees/west\\_delta/subsidence.cfm](http://www.water.ca.gov/floodsafe/fessro/levees/west_delta/subsidence.cfm).

## Delta Agricultural Water Agencies

In 1974, the Delta Water Agency was replaced by six Delta agricultural water agencies: North Delta Water Agency, South

Delta Water Agency, Central Delta Water Agency, Contra Costa County Water Agency, East Contra Costa Irrigation District, and Byron-Bethany Irrigation District. In 1981, North Delta Water Agency and East Contra Costa Irrigation District signed water rights management contracts with DWR. DWR negotiated contracts and requested negotiations with other agencies to provide water level, circulation, and quality needs in certain areas.

### South Delta Water Agency Contract

In September 1990, DWR completed negotiations for a long-term agreement with South Delta Water Agency and Reclamation. Under this proposal, the South Delta contract, the parties agreed to proceed with the design, construction, and operation of certain barrier facilities in the South Delta channels. These facilities resolved those portions of the lawsuit that South Delta Water Agency filed in 1982 regarding the alleged effects of export pumping by SWP and CVP on water levels, quality, and circulation in the South Delta.

DWR has installed and operated temporary barrier facilities in the South Delta to improve area conditions, as well as collect data needed to design and operate permanent barrier facilities. Ongoing efforts are being made to improve water levels, circulation, and water quality in South Delta channels. These efforts include modifying and dredging around local diverters' intakes, conducting a series of computer modeling studies, and modifying barrier flap gate operations. Other alternatives being considered include changing barrier heights at Middle River by 1 foot, dredging portions on upper Middle River, and installing portable pumps at Paradise Cut. Data collected in the Temporary Barriers Program were used to assess the barriers' ability to reduce or eliminate adverse water levels and improve local hydraulic circulation patterns.

### Western Delta Municipal Water Users

DWR signed contracts with Contra Costa Water District in 1967 and the City of Antioch in 1968. These contracts compensate Contra Costa and Antioch for purchasing water of usable quality when such water is not available from Mallard Slough and the San Joaquin River.

According to the contract terms, DWR compensates each agency for the additional costs of purchasing a substitute water supply from the Contra Costa Canal. This water is purchased to replace water supplies of usable quality which are lost due to SWP operations. Credits for the number of days of above-average water supplies of usable quality, from Mallard Slough and the San Joaquin River, accrue to offset the number of below-average days in future years.





Photo: Leslie Hamamoto

## Chapter 3

# Environmental Programs

*Woolly rose mallow*, *Hibiscus lasiocarpus* var. *occidentalis*.

## Significant Events in 2007

**I**nvasive quagga mussels were found in the Lower Colorado River in January 2007.

Winter and spring 2007 were among the driest on record since 1994. Low outflow likely contributed to record low abundance indices for several pelagic fishes in the upper San Francisco Bay/Sacramento-San Joaquin Delta Estuary.

In May 2007, a federal judge found the existing biological opinion on the effects of coordinated operations of the Central Valley Project and State Water Project on the delta smelt was inadequate and ordered U.S. Fish and Wildlife Service to issue a new delta smelt biological opinion by September 2008.

Northern pike eradication efforts at Lake Davis led to the temporary closure and large scale rotenone application there in September 2007.

On November 20, 2007, the Habitat Expansion Agreement for Central Valley Spring-Run Chinook Salmon and California Central Valley Steelhead was signed.

The State Water Resources Control Board approved a 1-year transfer of up to 125,000 acre-feet to the Department of Water Resources in 2007, the second pilot year transfer under the Lower Yuba River Accord (Yuba Accord).

*The Agreement for the Long-Term Purchase of Water from Yuba County Water Agency by the Department of Water Resources was signed on December 4, 2007 as one element of implementing the Yuba Accord.*

*Information in this chapter was contributed by the State Water Project Analysis Office, the Division of Environmental Services, the Division of Operations and Maintenance, and the Division of Integrated Regional Water Management.*

The Department of Water Resources (DWR) has developed and implemented several programs to avoid, minimize, or offset adverse environmental impacts resulting from construction and operation of State Water Project (SWP) facilities.

## Operations for Species of Concern

A primary consideration in the operation of the SWP is avoiding, minimizing, and offsetting adverse impacts to species of concern, species listed as threatened or endangered by a State or federal agency, or species proposed for listing). The SWP is operated pursuant to biological opinions issued under the federal Endangered Species Act (ESA), as well as consistency determinations or incidental take permits issued under the California Endangered Species Act (CESA). A key to avoiding and minimizing adverse impacts to these species is maintaining flexibility in SWP operations, which is done mainly through the Environmental Water Account (EWA). EWA provides protection to Delta fisheries through changes in SWP and Central Valley Project (CVP) operations, while maintaining water supply reliability to the projects' water users. Operational responses can include Delta Cross Channel gate closure, export curtailments, changes in delivery schedules, increased reservoir releases, preferential use of certain facilities, or a combination of these actions. (Additional information about EWA can be found later in this chapter and in Chapter 7, Supply Development and Reliability and Chapter 9, Water Contracts and Deliveries.)

### San Joaquin River Activities

DWR and the Bureau of Reclamation (Reclamation) coordinate to increase flows in the San Joaquin River during the pulse flow period, from April 15 through May 15, to benefit fall-run Chinook salmon emigrating from the San Joaquin River Basin.

This plan, known as the Vernalis Adaptive Management Plan (VAMP), is a 12-year federal and State research component of the San Joaquin River Agreement. VAMP calls for intensive fisheries sampling in the lower San Joaquin River during the pulse flow period. Studies coordinate variable export pumping rates with fisheries collection efforts to estimate the relative survival of marked salmon moving through the Delta under VAMP during the pulse flow period. The goal is to conduct operational changes and associated studies from 1999 to 2010 to determine if a relationship exists between river flow, Delta exports, and salmon survival throughout the southern Delta. The resulting information will be used to determine if changing San Joaquin River flows and Delta exports in the spring can significantly benefit San Joaquin River fall-run Chinook salmon.

Actions associated with VAMP were implemented between April 22 and May 22, 2007. The VAMP test period was delayed one week from the default period of April 15 through May 15 to allow test fish to increase to a size that would accommodate implantation of acoustic tags. Flow and fisheries monitoring were conducted in the lower San Joaquin and Old rivers and the Delta.

### Temporary Barriers

VAMP-participating agencies install temporary barriers in the San Joaquin River to provide an adequate water supply for South Delta water diverters, improve water quality in the Stockton Deep Water Channel, and prevent entrainment of juvenile Chinook salmon at the South Delta facilities.

In 2007, a temporary barrier was installed at the Head of Old River in the spring from April 20 to June 6 and in the fall from October 17 to November 29. The spring season barrier improves conditions for out-migrating juvenile Chinook salmon while the fall barrier prevents adult salmon from migrating into the area.

Temporary agricultural barriers are installed to increase water levels in the South Delta for local water users. In 2007, barriers were installed at Middle River from April 10 to November 20; at Old River near Tracy from April 18 to November 18; and at Grant Line Canal from May 10 to November 29.

Brief background information about the temporary barriers can be found in Chapter 2, Delta Resources.

### ***San Joaquin River Restoration Program***

In 2006 the San Joaquin River Restoration Program (SJRRP) was established to implement the court settlement to restore 153 miles of the San Joaquin River from Friant Dam to the confluence of the Merced River. The agencies responsible for the implementation of the program include Reclamation, U.S. Fish and Wildlife Service (USFWS), National Marine Fisheries Service (NOAA Fisheries), DWR, and the California Department of Fish and Game (DFG). During 2007 many organization and management actions were initiated to provide a structure for the SJRRP. A Program Management Plan was completed in May 2007 to provide a framework and strategy that the implementing agencies will use to collaborate and adaptively implement the program. Four technical work groups were formed to support the SJRRP: Water Management, Engineering and Design, Environmental Compliance and Permitting, and Fisheries Management.

In August 2007, both the National Environmental Policy Act (NEPA) and

California Environmental Quality Act (CEQA) processes were initiated for the overall program with Reclamation as the NEPA lead agency and DWR as the CEQA lead agency. A Notice of Intent and a Notice of Preparation for a draft program environmental impact statement (EIS)/environmental impact report (EIR) were issued. Scoping and other outreach meetings were conducted, beginning the first phase of implementing the SJRRP.

More information about SJRRP is available on the program's website: <http://www.restoresjr.net>.

### **Environmental Water Account**

The Environmental Water Account (EWA) was established in the CALFED programmatic EIS/EIR Record of Decision. The EWA is a cooperative management program for fishery protection, restoration, and recovery needs. Water assets acquired through banking, borrowing, transferring, and arranging conveyance are used to augment stream flows and Delta outflows; modify water exports during critical stages of fish life cycles; and replace water supply that may be interrupted by changes to water operations associated with fish protective actions.

### **Lower Yuba River Accord**

The Lower Yuba River Accord (Yuba Accord) was announced in 2005 to settle long-standing litigation over instream flows in the Yuba River in relation to fisheries. The purpose of the Yuba Accord is to resolve instream flow issues associated with the operation of the Yuba River Development Project (Yuba Project [includes New Bullards Bar Dam and Reservoir, and several small water and hydroelectric facilities located above and below Englebright Dam]) in a way that protects and enhances lower Yuba River fisheries and local water supply reliability. The Yuba Project provides revenues for local flood control and water supply projects,

water for the CALFED EWA for protection and restoration of Sacramento-San Joaquin Delta fisheries, and improvements in statewide water supply management, including dry year water supplies for participating SWP and CVP contractors.

The pilot programs are essential for the Yuba Accord's development. Under the 2006 and 2007 programs, the Yuba Project released water from New Bullards Bar Reservoir to meet significantly higher minimum instream flows for the fisheries resources of the lower Yuba River.

The Yuba Accord pilot programs include water sales to the CALFED Bay-Delta Program EWA to benefit the fisheries resources of the Bay-Delta. Revenues from these sales help fund the cost of the Yuba Accord's EIR/EIS and implementation of the Yuba Accord, as well as other activities, such as Yuba Project's share of costs for ongoing flood protection efforts in Yuba County.

The State Water Resources Control Board (SWRCB) approved a second 1-year pilot program for the Yuba Accord in February 2007. Yuba Project filed a separate petition under Water Code Section 1700 to change the effective date of the long-term flow requirements to April 1, 2008. Order WR 2007-0002 approved Yuba Project's petition to change the effective date of the interim instream flows under Permit 15026 to April 1, 2008.

*The Agreement for the Long-Term Purchase of Water from Yuba County Water Agency by the Department of Water Resources* was signed on December 4, 2007 as one element of implementing the Yuba Accord. In accordance with the agreement, DWR paid Yuba \$30,900,000 for 60,000 acre-feet (af) of Component 1 water per year for 2008 through 2015 (480,000 af in total) for EWA program purposes. In addition, DWR began the process of executing agreements with

participating SWP and CVP contractors for dry year water under the Yuba Accord.

## Oroville Facilities Relicensing

DWR continued to seek a new 50-year license from the Federal Energy Regulatory Commission (FERC) to generate hydroelectric power while meeting existing commitments and complying with laws and regulations regarding water supply, flood control, the environment, and recreational opportunities. Though the previous license expired on January 31, 2007, the project continued to operate under an annual license issued by FERC.

USFWS issued a terrestrial biological opinion (BO) for the Oroville Facilities Relicensing Project (FERC File Number 2100), Butte County, California, on April 9, 2007. This BO addressed the continued operation of the Oroville facilities for power generation and the terms and conditions of the new FERC license and the *Settlement Agreement for Licensing of the Oroville Facilities* (Settlement Agreement). USFWS determined the project could affect five federally listed species within the project area: valley elderberry longhorn beetle, vernal pool fairy shrimp, vernal pool tadpole shrimp, giant garter snake, and bald eagle. Effects include 12 acres of elderberry shrub habitat, 9.5 acres of vernal pool habitat, 450 acres of giant garter snake habitat, and unknown effects on bald eagle nesting sites. However, given a number of conservation measures proposed by DWR, USFWS determined that the project would not jeopardize these species.

On July 11, 2007, DWR submitted the biological assessment and essential fish habitat assessment evaluating the effects of the Settlement Agreement and issuance of a new FERC license on federally listed anadromous fish. Anadromous species addressed in the biological assessment include Central Valley spring-run Chinook

salmon, California Central Valley steelhead, southern distinct population segment (DPS) of North American green sturgeon, Central California Coast steelhead, and Sacramento River winter-run Chinook salmon.

## Habitat Expansion Agreement

On November 20, 2007, the *Habitat Expansion Agreement for Central Valley Spring-Run Chinook Salmon and California Central Valley Steelhead* (HEA) was signed. This agreement, a component of the relicensing Settlement Agreement, states that DWR and Pacific Gas & Electric Company (PG&E) (the licensees) will restore or expand spawning, rearing, and holding habitat to accommodate a net increase of 2,000 to 3,000 spring-run Chinook salmon in the Sacramento River basin. This agreement was signed as an alternative to Federal Power Act, Section 18 fish passage prescriptions which may be required by NOAA Fisheries. The signing of the HEA begins a 2-year collaborative process in which DWR and PG&E will assess and select a project or projects that will accomplish this threshold, using a number of predetermined criteria outlined in the HEA. DWR and PG&E will be required to submit a Draft Habitat Expansion Plan by November 20, 2009, at which time the other signatories to the Settlement Agreement will be given an opportunity to comment on the plan prior to final approval from NOAA Fisheries.

DWR and PG&E entered into the Habitat Expansion Coordination Agreement (HECA), also effective November 20, 2007, to ensure that DWR and PG&E coordinate their decision-making and implementation of actions to achieve the goals of the HEA, as well as share costs incurred during the planning and implementation of habitat expansion actions. The HECA, which defines the roles and responsibilities of DWR and PG&E for implementing the HEA, ensures that DWR and PG&E fulfill their obligations under the HEA and achieve the HEA habitat

expansion goals in an efficient and cost-effective manner.

For more information, visit the Oroville Relicensing website at <http://www.water.ca.gov/orovillereLICensing> or the HEA website at <http://www.sac-basin-hea.com>.

## Invasive Species

### Northern Pike Containment and Eradication, Lake Davis

Northern pike is a nonnative aggressively invasive fish species illegally introduced into two of the SWP's Upper Feather Reservoirs during the 1980s and 1990s. The risk posed by northern pike, and innovative measures undertaken by DFG and DWR to contain and prevent its spread, were described in detail in Bulletin 132-07. The selected option to eradicate northern pike from the SWP's Lake Davis, and prevent its potentially catastrophic spread into other waters of the State, was implemented in September 2007.

Lake Davis is located in Plumas County on Big Grizzly Creek, a tributary to the Middle Fork Feather River. The 84,000 af capacity reservoir, formed by Grizzly Valley Dam, is operated by DWR for the primary purposes of recreation, fish and wildlife enhancement, and water supply.

Northern pike were discovered in Lake Davis in 1994. DFG subsequently implemented the first Lake Davis pike eradication project in October 1997, a controversial application of the fish pesticide ("piscicide") rotenone. However, pike were rediscovered in Lake Davis in 1999, having either survived treatment or having been illegally reintroduced.

After a multiyear, stakeholder-driven effort directed at containment and control, DFG proposed a second pike eradication project for Lake Davis and its tributary waters. In January 2007, DFG completed and certified a

final EIR/EIS, selecting a project alternative that minimized impacts to ongoing recreation and the other natural and cultural resources associated with the reservoir. The selected project alternative was chemical treatment (rotenone) of the lake and its upper tributaries.

Throughout 2007, staff from DWR worked with DFG to implement the eradication project. DWR and DFG executed an interagency agreement on August 24, 2007 which outlined the responsibilities of DFG and DWR to maintain an adequate water supply to parties with water rights downstream of Grizzly Valley Dam, provide access to DWR property, provide for streamflow curtailment, and for DWR assistance to DFG as necessary including Big Grizzly Creek fish relocation efforts. Over the course of the summer, the level of Lake Davis was drawn down to 43,000 acre-feet to help reduce the amount of chemicals required and to improve the effectiveness of the piscicide. DWR executed an amendment to the DWR-DFG Big Grizzly Creek minimum flow agreement on July 27, 2007 and obtained a temporary urgency change to its water rights for Lake Davis from SWRCB on August 29, 2007 to allow the cutoff of all releases and deliveries from the dam during treatment.

In cooperation with the Forest Service (Plumas National Forest), the area surrounding Lake Davis was closed following the Labor Day 2007 holiday weekend. Grizzly Valley Dam discharge to Big Grizzly Creek was suspended by DWR on September 25, 2007 to prevent discharge of the piscicide chemicals to downstream waters. Over two days, DFG applied several thousand gallons of rotenone products to the reservoir and its upstream tributaries.

The selected chemical neutralization option was natural degradation in the lake which required that the outlet from the Dam remain closed until no trace of the chemicals

remained. DPH and DFG continued to conduct water and sediment monitoring to ensure there was no detectable residuals remaining of chemical constituents before the lake could be returned to service as a drinking water source. Plumas County and the City of Portola proceeded with plans for construction of a new water treatment plant at Lake Davis, for delivery of the county's SWP allocation from Lake Davis. DFG and DWR committed to additional seasons of post-project monitoring to ensure eradication project success. This includes continued operation of the Northern Pike Containment System (see Bulletin 132-07), at the outlet of Lake Davis on Big Grizzly Creek, to provide ongoing assurance that if any northern pike survive, neither adults, larvae, or eggs have the opportunity to move downstream.

## Quagga Mussel Monitoring

The quagga mussel, *Dreissena rostriformis bugensis*, and the closely related zebra mussel, *D. polymorpha*, are invasive aquatic species. The mussels colonize hard or soft substrates, but tend to attach to structures, clogging power generation facility cooling and pumping plant systems and trash racks, screens, internal piping, strainers, and filters used in municipal, industrial, and agricultural water delivery systems. The resulting damage to infrastructure can cost billions of dollars in maintenance or repair.

Quagga mussels are prolific invaders and can have major ecological impacts on the water bodies they invade. Being very efficient water filterers, they can change the base of the food web by removing substantial amounts of phytoplankton and suspended particulates from the water. They can attach to other clam and mussel species, eventually smothering and out competing them. A widespread, high density population of quagga mussels may contribute to algal blooms. Potential economic impacts include the cost of training, monitoring, and control efforts by public agencies, nonprofit

organizations, and private entities and lost revenue due to decreased property values, impacts on fisheries, or decreased use of water for swimming, boating, fishing, and other recreational activities. Once the mussels establish themselves in a water body, they are difficult to eradicate, making prevention vital. Introduction of mussels into SWP facilities and water bodies is a serious threat.

The adult and juvenile mussels are spread when they are inadvertently moved from one water body to another in or on trailered boats or any type of aquatic vehicles or equipment. Larval mussels also spread by drifting downstream. Quagga mussels can quickly infest a water body, and once they are established, there is no economically feasible method of eradication, therefore the best course of action is preventing the spread of mussels by cleaning and drying aquatic equipment before using it in another water body.

Quagga mussels were discovered in January 2007 in Lake Mead, and subsequent surveys found them in Lakes Mohave and Havasu and part of the Colorado River Aqueduct (CRA) that serves Southern California. It was the first discovery of these mussels west of the Continental Divide. They are believed to have entered the Colorado River system in boats trailered there from infested waters in the Midwest. In August 2007 they were discovered in San Diego and Riverside county reservoirs served by the CRA.

Immediately following the quagga mussel discovery, an interagency Incident Command System (ICS) was established, led by DFG and supported by DWR, Department of Food and Agriculture, Department of Boating and Waterways, and USFWS. The assembled Quagga Mussel Incident Response Team implemented a detection and delineation survey for quagga mussels in prioritized waterways in California,

mobilized agricultural inspection stations to focus on boat inspections, conducted a feasibility assessment of eradicating the quagga mussel in the Lower Colorado River, and developed a strategic plan for statewide mussel detection, management, and control. DWR began monitoring the SWP for quagga mussels shortly after the mussels were first detected in California. No mussels were found in the SWP or its associated watersheds. Metropolitan Water District of Southern California (Metropolitan) began surveying and monitoring the CRA, first discovering mussels in March 2007 and eventually finding mussels throughout the entire CRA system. The City of San Diego's survey activities discovered mussels in the San Diego Aqueduct.

Considering there is no ecologically and economically feasible method of eradicating widespread mussel infestations in large water systems, early management efforts focused on: (1) monitoring to establish the extent of the invasion; (2) mandatory boat inspections at all agricultural inspection stations; (3) public outreach to prevent the inadvertent transport of mussels by recreational boaters; and (4) outreach and mussel identification training of State and water district staff, including biologists, maintenance craftsmen, infrastructure inspectors, and law enforcement officers. DWR offered several training workshops on quagga mussel surveying techniques and identification. The ICS demobilized in March, but federal and State agency representatives who were involved in the incident continued to work on action items identified by the Quagga Mussel Incident Response Team.

In April 2007, a science advisory panel was convened to plan California's response to the invasion. Their report, *California's Response to the Zebra/Quagga Mussel Invasion in the West*, released in May 2007, contains science advisory panel recommendations in three operational areas: control and eradication in currently infested waters; containment



within those waters; and monitoring to detect new infestations. The report also included recommendations for future research priorities. The report recommends that agencies proceed with advance planning for responding to new infestations and reducing the impacts from infestations that are not prevented or eradicated.

More information about the quagga mussel is provided on agency websites.

DFG, <http://www.dfg.ca.gov/invasives/quaggamussel>

USGS, <http://nas.er.usgs.gov/taxgroup/mollusks/zebramussel>

DWR, [http://www.water.ca.gov/environmentalservices/invasive\\_species.cfm](http://www.water.ca.gov/environmentalservices/invasive_species.cfm)

## Biological Opinions Issued on the CVP/SWP Operating Criteria and Plan

The CVP and SWP Long-Term Operations Criteria and Plan (OCAP) incorporates measures to provide protection for ESA listed fish species. In July 2006, Reclamation requested reinitiation of ESA Section 7 consultation with NOAA Fisheries and USFWS regarding future combined CVP and SWP operations. During 2007, DWR, Reclamation, NOAA Fisheries, USFWS, and DFG met regularly to develop a formal consultation initiation package. Two biological opinions from 2004 remained in effect in the interim.

### U.S. Fish and Wildlife Service Biological Opinion

In 2004 USFWS issued a BO finding that the proposed coordinated operations of the SWP and CVP would have no adverse effect on the continued existence and recovery of the delta smelt and its critical habitat. In May 2007, a federal judge ruled that the 2004

OCAP BO did not adequately protect delta smelt, and that it was unlawful because it did not ensure that appropriate mitigation actions would take place, it was not based on the best available scientific information, it specified take limits that failed to consider recent declines in abundance, and it failed to consider impacts to critical habitat. The court remanded the 2004 BO and ordered a new OCAP BO be completed by September 2008.

The court issued an interim remedial order in December 2007 which modified CVP and SWP operations for the protection of delta smelt until the new BO is completed. The order set limits on net upstream (reverse) flow in Old and Middle rivers due to CVP and SWP exports in order to reduce the risk of entrainment of delta smelt at the pumps.

### NOAA Fisheries Biological Opinion

In 2004, NOAA Fisheries issued a BO concluding that continuation of OCAP is not likely to jeopardize the continued existence of spring-run Chinook salmon or steelhead in the Central Valley. Since that opinion was issued, there have been new species listings and new critical habitat designations for listed species.

During this time, reasonable and prudent measures to minimize take of spring-run Chinook salmon and steelhead outlined in the 2004 BO were followed, as outlined in Bulletin 132-07.

### Delta Export Curtailment

A team of interagency scientists known as the Delta Smelt Working Group (DSWG) met throughout 2007 to review smelt distribution and abundance based on monitoring and survey data and to recommend actions for water project operations that would reduce salvage. In January 2007, the DSWG recommended maintaining a net upstream (negative) combined OMR flow no greater than 5,000 cubic feet per second (cfs) throughout winter and spring, until the

## Endangered Species Acts

Section 7 of the Endangered Species Act requires federal agencies to ensure that any action authorized, funded, or carried out by them is not likely to jeopardize the continued existence of listed species or modify their critical habitat, formal consultation is required. Federal agencies must consult with either the U.S. Fish and Wildlife Service and/or the National Marine Fisheries Service. As part of the consultation process, wildlife agencies issue a biological opinion (BO). Where appropriate, a BO provides an exemption for the take of listed species. If an action is determined by an agency to jeopardize a species or adversely modify critical habitat, agencies suggest Reasonable and Prudent Alternatives that the action agency may take to avoid the likely jeopardy or adverse modification (Title 16, United States Code Sections 1531–1544 [1973]). The California Endangered Species Act is substantially similar in all aspects (California Fish and Game Code Sections 2050–2098 [1984]).

An endangered species is one in danger of extinction in all or a significant portion of its range; a threatened species is one likely to become endangered. These acts are designed to protect threatened and endangered species by ensuring federal and State agencies adopt measures to protect the species during the design, construction, and operation of projects and in taking other forms of agency action; and prohibiting the unauthorized take of endangered species.

risk of smelt entrainment abated. Due to low delta smelt abundance indicated by monitoring surveys, DSWG provided an additional recommendation on May 14 of no net negative OMR flow until Delta temperatures reach the lethal threshold for delta smelt.

In 2007, 2,343 delta smelt were salvaged by SWP and 348 were salvaged by CVP. This represents an increase in salvage at both facilities compared with a combined annual salvage of 336 at both facilities in 2006.

## The Bay-Delta Conservation Plan

The Bay-Delta Conservation Plan (BDCP) is a current effort by DWR, Reclamation, Mirant Delta, LLC, and the State and federal water contractors to attain long-term take authorization under the CESA and

ESA while providing for the conservation and management of covered species in the Sacramento-San Joaquin Delta. When completed, the BDCP will provide a plan to restore and protect water supply, water quality, and ecosystem health within a stable regulatory framework. The BDCP will be composed of a Habitat Conservation Plan and a Natural Community Conservation Plan. The Resources Agency acts as facilitator for the BDCP Steering Committee, which consists of the applicants or potentially regulated entities mentioned above, fish and wildlife agencies (DFG, USFWS, NOAA Fisheries), and some nongovernmental organizations.

The BDCP Planning Agreement was signed on October 6, 2006 by all members of the steering committee, and a draft work plan was drawn up that outlines the tasks to be completed by the primary consultant,

Science Applications International Corporation (SAIC).

During 2007, the BDCP Steering Committee assembled an independent science panel which produced the first BDCP *Independent Science Advisors Report* in September. During the first half of 2007, the Steering Committee developed a list of 10 conceptual conservation strategies, evaluated those strategies, and shortened that list to four Conservation Strategy Options which were published in the *Options Evaluation Report*. In November, the Steering Committee produced a document titled *Points of Agreement for Continuing into the Planning Process* which will guide formulation of a comprehensive conservation strategy during 2008.

For more information, see Chapter 2, Delta Resources, or visit the BDCP website: <http://baydeltaconservationplan.com>.

## Decisions on Endangered Species

### North American Green Sturgeon

The Southern DPS of North American green sturgeon, *Acipenser medirostris*, was listed as threatened under the federal ESA in 2006 (see Bulletin 132-07). On April 17, 2007, the Center for Biological Diversity filed a notice of intent to sue NOAA Fisheries for failing to designate critical habitat for the Southern DPS of green sturgeon, as required by the ESA. A settlement agreement was reached, and proposed critical habitat designation is expected in 2008.

### Delta Smelt

In 2006, the Center for Biological Diversity, Bay Institute, and Natural Resources Defense Council filed a petition with USFWS to uplist delta smelt, *Hypomesus transpacificus*, from threatened to endangered species status under the federal ESA (Bulletin 132-07). A similar petition was filed with the California Fish and Game Commission (FGC) in February 2007. The petitions state that record

low abundance levels, population viability analysis, loss of habitat, and increasing occurrence of multiple known threats are evidence that the species is at risk of extinction.

On May 24, 2007, the Center for Biological Diversity filed a notice of intent to sue the USFWS for failure to respond to the 2006 petition. On June 7, 2007, the California FGC accepted the petition to consider uplisting the delta smelt to endangered species status under CESA, initiating a 12-month review of the species' status.

### Longfin Smelt

On August 8, 2007, the Bay Institute, Center for Biological Diversity, and the Natural Resources Defense Council petitioned the USFWS to list the Bay-Delta population of longfin smelt as threatened or endangered under the federal ESA, and petitioned FGC to list the fish statewide under CESA. The petition cites four consecutive years of record low population abundance indices (Figure 3-1), reduced genetic integrity, and threats by water management practices as reasons that warrant the proposed listing.

## Trends in Fish Abundance

Figure 3-2 shows the abundance index for delta smelt, from 1967 through 2007, based on fall midwater trawl sampling. Using only the first two tow net surveys, delta smelt abundance indices are calculated as the product of the total catch at each site and a weighting factor that represents the estimated water volume for the site, divided by 1,000. The fall abundance index provides one of the best indicators of the status of the adult delta smelt population. The 2007 index was the second lowest on record. Since 2002, abundance indices for this species have been lower than expected.

Figure 3-3 shows estimates of returning adult winter-run Chinook salmon from 1967 through 2007. These estimates are referred

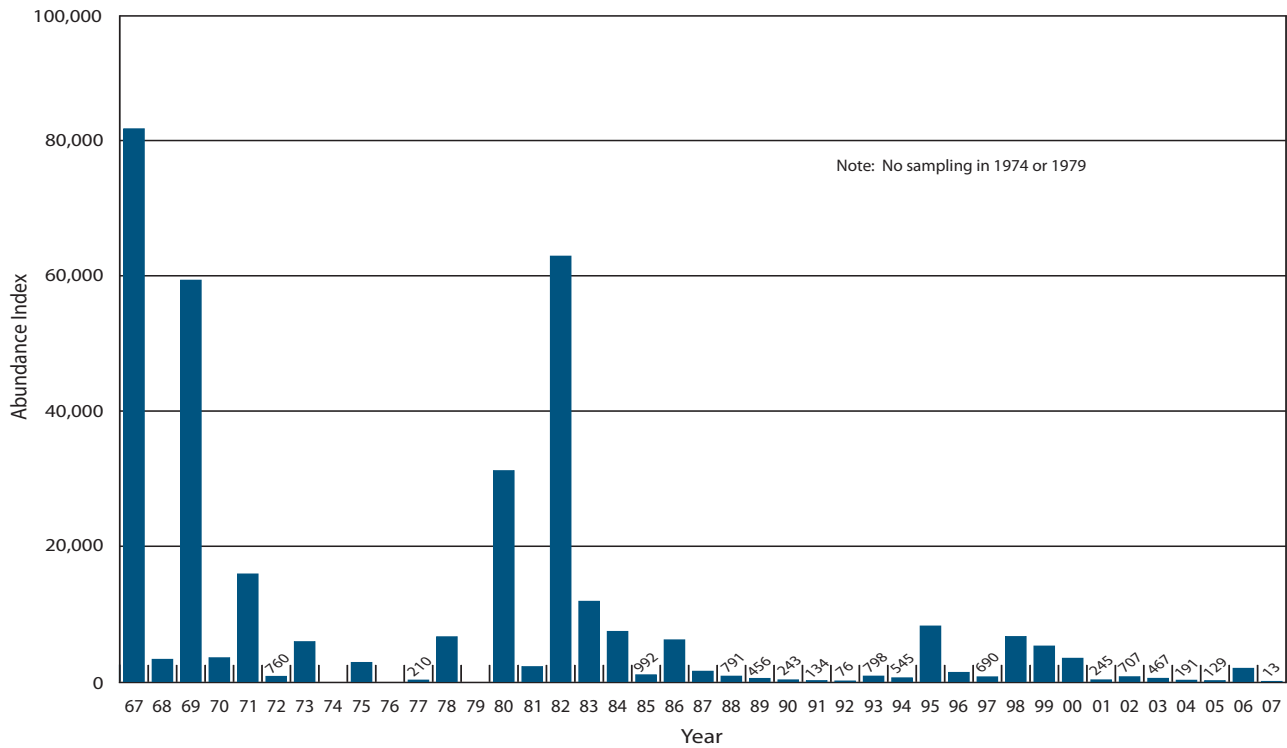


Figure 3-1 Longfin Smelt Fall Midwater Trawl Abundance Index, 1967–2007

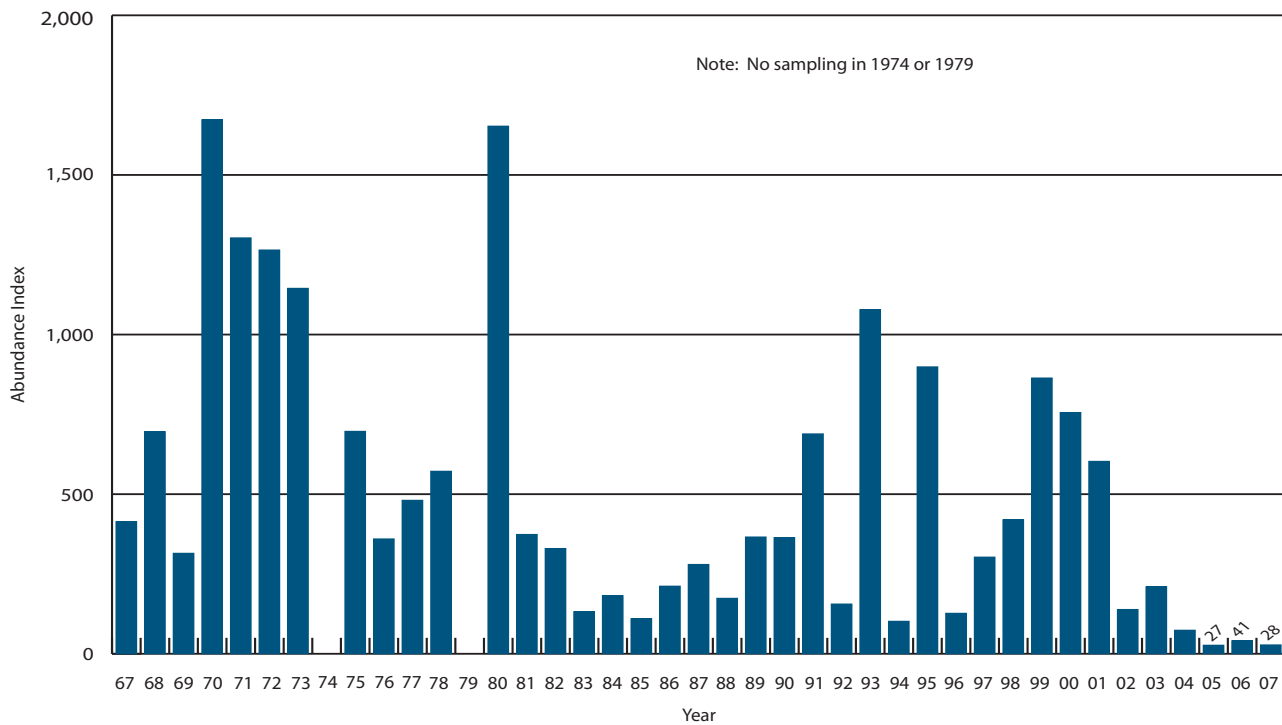
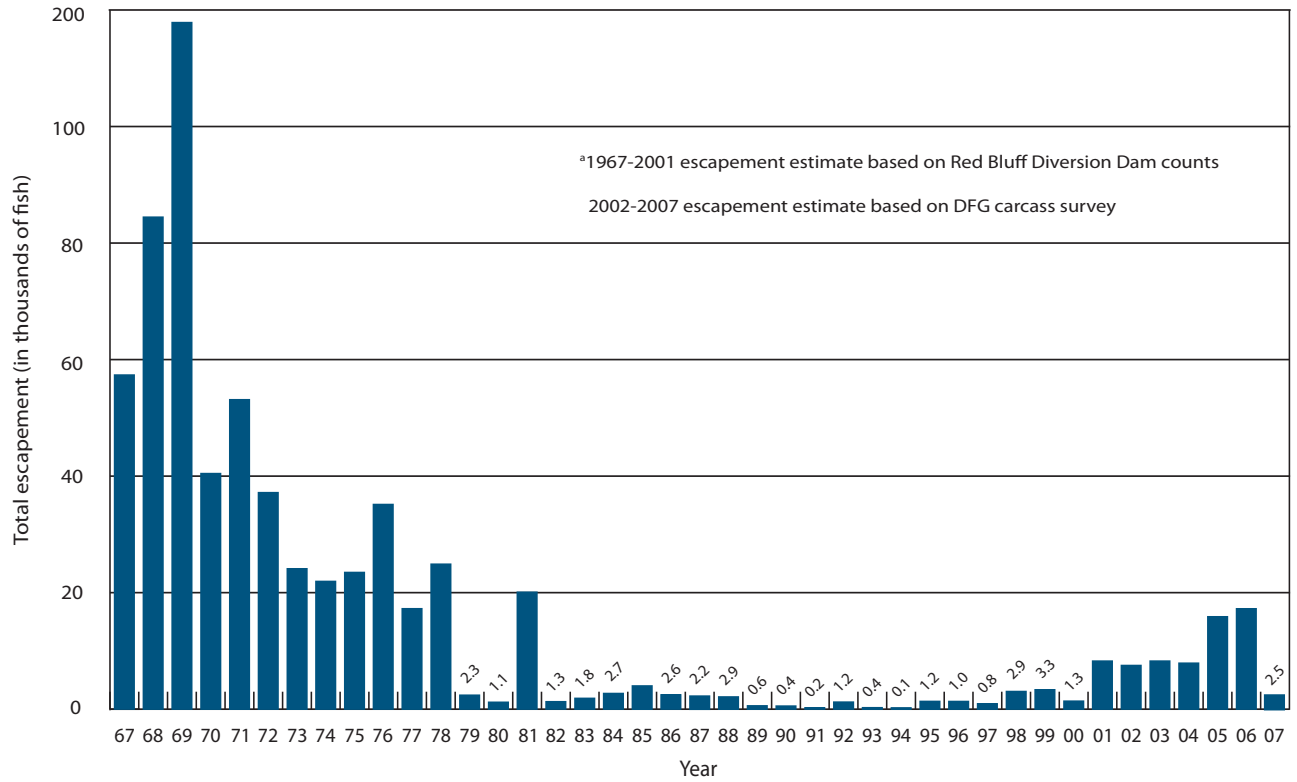
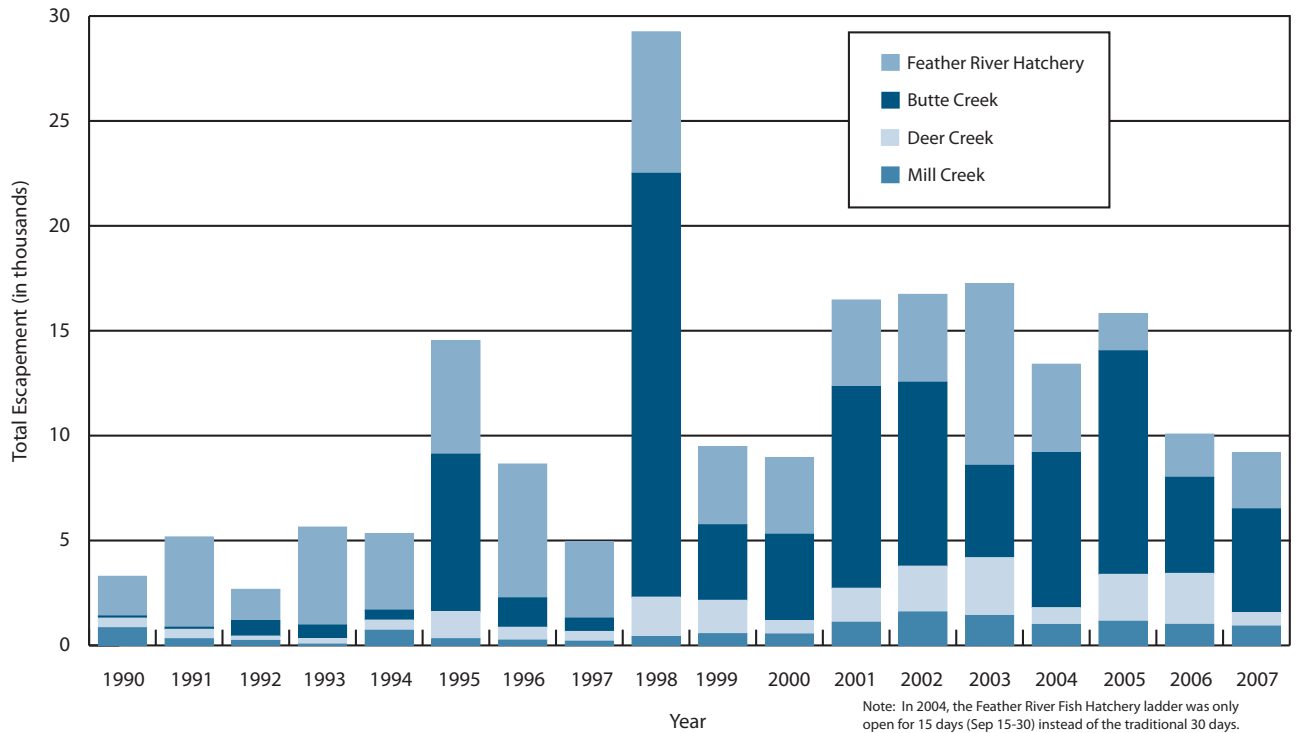


Figure 3-2 Delta Smelt Fall Midwater Trawl Abundance Index, 1967–2007



**Figure 3-3 Estimated Total Adult Winter-Run Chinook Salmon Escapement, 1967–2007<sup>a</sup>**



**Figure 3-4 Estimated Spring-Run Chinook Salmon Escapement, 1990–2007**

to as escapement estimates—the number of adults that escape mortality and return to spawn. The Sacramento River winter-run Chinook salmon escapement estimates are generated using data from the DFG carcass survey. DFG has been using the carcass survey data to generate escapement estimates since 2002. Prior to 2002, Red Bluff Diversion Dam counts were used to generate the escapement estimate. The estimated winter-run Chinook escapement for 2007 was 2,488, which is a drastic decline from the increasing trend that began in 2001. It is about half of the parent stock of 2004. Figure 3-4 shows estimates of returning adult spring-run Chinook salmon, from 1990 through 2007. Individual estimates are shown for the principal spring-run spawning streams, Mill Creek, Deer Creek, and Butte Creek, and the Feather River Fish Hatchery (FRFH).

The escapement estimates are shown separately for each stream, because the Feather River estimate is based on returns to the FRFH, where the genetic integrity of spring-run Chinook salmon is uncertain. The estimated escapement for 2007 was 2,675 for FRFH and about 6,500 for the other streams combined. The 2007 FRFH escapement was only about 63 percent of the 2004 parent stock escapement estimate. The escapement of naturally spawned fish for Mill, Deer, and Butte creeks is about 71 percent less than the 2004 parent stock.

Due to lack of comprehensive monitoring programs, there are no reliable escapement estimates for wild Central Valley steelhead.

## Feather River Fish Studies

In the early 1990s, the Feather River fish studies were initiated to document and monitor fish populations in the lower Feather River. Early efforts focused on studies to identify flow requirements for Chinook salmon and steelhead. The program progressively expanded since the mid-1990s

in preparation for the FERC relicensing of the SWP Oroville-Thermalito Complex. Field program elements have expanded to include the operation of rotary screw traps, acoustic and radio telemetry, salmon escapement surveys, spring-run Chinook tagging, and otolith thermal marking studies.

## Rotary Screw Traps

Over the last 10 years, DWR has used rotary screw traps (RST) as the primary method to assess the general abundance and timing of emigrating juvenile salmon and steelhead in the lower Feather River. This long-term monitoring effort yields valuable baseline information about juvenile salmonid production in lower the Feather River and the effects of project operations on abundance and migration timing.

Emigration timing and speed measurements confirm that most naturally produced juvenile Chinook salmon move rapidly through the upper reaches of the lower river. Consistent with select years of trapping data, turbidity may influence the emigration timing of naturally produced juvenile salmon. However, other studies demonstrate that the timing of adult spawning plays a large role in determining juvenile salmon emigration patterns as well.

The 2007 season was fished throughout the emigration period (December through June). Two RST locations were used to assess the timing and general abundance of juvenile Chinook salmon, steelhead, and other fish species emigrating the Feather River. Within the low-flow channel (LFC; Fish Barrier Dam to Thermalito Afterbay Outlet), one RST at Steep Riffle (river mile [RM] 61) provided a passage estimate of 4,496,445 juveniles. Within the high-flow channel (HFC; Thermalito Afterbay Outlet [TAO] to the confluence with Honcut Creek), one RST located just below Sunset Pumps at RM 38 was unable to produce a passage estimate due to gaps in the data resulting from high-flow events. Although Chinook

salmon and steelhead were the primary targets of trapping efforts, records were kept on all fish species caught. Thirty-one species were caught during the trapping season. Chinook salmon was the dominant species, comprising approximately 98 percent of the catch.

## Acoustic and Radio Telemetry

Acoustic and radio telemetry gathers baseline information on the migration and holding patterns of adult Chinook salmon in the river. A telemetry study was conducted to collect additional data to evaluate the relationship between water temperature and migration patterns of pre-spawning adult Chinook salmon in the Feather River below the Fish Barrier Dam.

Chinook salmon with spring-run life history enter freshwater in early summer and hold in their natal tributaries for up to several months before spawning. In order to collect additional data to evaluate water temperature and migration patterns of pre-spawning adult Chinook salmon, spring-run adult Chinook salmon are captured and radio tagged to document their habitat use. Because the water temperature regime associated with the ongoing operation of the Oroville facilities may expose pre-spawning adult Chinook salmon to elevated water temperatures during the migration and holding period, radio tagging was implemented to determine whether the pools downstream of the Thermalito Afterbay Outlet (TAO) provide water temperatures suitable for holding. Between May 3 and June 25, 2007, 45 adult Chinook salmon received an esophageal implant of a radio tag at the FRFH. Of the 45 tags deployed, 40 were subsequently located. A total of 12 tags were recovered: five were recovered during the escapement survey, two were recovered at the FRFH, and five were reported by anglers. The total gross distance traveled by the tagged fish ranged from 0 to

68.4 river miles. The largest surveyed net movement was 19.5 river miles downstream.

## Salmon Escapement Survey

The purpose of the salmon escapement survey is to evaluate the abundance, distribution, and timing of in-river Chinook salmon spawning.

The survey provides information crucial to monitoring, management, and conservation of the Feather River's salmon populations. The data are used to identify trends in population and age structure, track patterns in spawning distribution, determine proportions of hatchery versus wild fish, and explore environmental effects on salmon survival rates. Estimating the number of salmon returning to spawn is the basic goal of the carcass survey. This estimate is based on a weekly mark and recapture experiment in which salmon carcasses are tagged, chopped, and placed back into the river. The rate at which tagged carcasses are recovered (the recovery rate) relative to the number of carcasses checked for tags (chopped) provides the basis for an estimate of the total population.

The 2007 Chinook salmon spawning escapement survey began September 4 and continued through December 9. Due to the low numbers of returning fish, the data from the LFC and HFC were pooled to generate one estimate for the lower Feather River. A pooled Peterson estimator is used to calculate the escapement estimate. For the lower Feather River, the estimate was 21,862. There were an estimated 321 grilse (fish  $\leq$  65 cm fork length). These estimates include both fall-run and spring-run Chinook salmon since their spawning is currently not fully segregated on the Feather River. Approximately 96 percent of the spawning population utilized the LFC. This is higher than any of the previous years monitored since DWR began surveys in 2000. Since

2000, the long-term average for the LFC's spawning population is 67 percent.

### Spring-run Salmon Tagging

The spring-run Chinook salmon tagging program at the FRFH is an attempt to better segregate spawning of spring- and fall-run Chinook salmon in the hatchery. The program also investigates potential differences in spawning distribution and timing of the early arriving spring-run salmon in the river and contributes to a better understanding of spring-run salmon life history in the Feather River. Early arriving spring-run salmon entering the hatchery were marked with individually numbered Hallprint dart tags for identification purposes. Once marked, fish were released back in the river and allowed to over-summer there. During the hatchery spawning season, the mark enabled the hatchery to distinguish the early arriving spring-run from the fall-run fish, so that spring-run fish could be spawned separately from the fall-run. The mark also enabled the escapement survey crew to differentiate between spring- and fall-run salmon, so that any potential differences or trends in spawning behavior of the two runs could be analyzed.

Between May and July 2007, 9,756 spring-run Chinook salmon were marked. During the marking period, 1,527 marked spring-run salmon were recaptured in the FRFH and returned back to the river. When spawning commenced in the fall, a total of 2,873 marked fish were recovered: 1,849 at the FRFH, 773 in the river escapement survey, and 251 by anglers. The FRFH successfully spawned 1,403 (76 percent) marked spring-run salmon that returned to the hatchery.

### Otolith Thermal Marking Studies

The Chinook salmon run in the Feather River consists of Central Valley spring-run and fall-run, both heavily supplemented by the FRFH. In order to more effectively determine the

composition of the run (spring-run versus fall-run) and the origin of the fish (hatchery versus naturally produced), DFG and DWR developed an otolith thermal marking program (OTM) for the FRFH. Thermal marking provides an efficient method to mark 100 percent of the fish produced at the hatchery.

In 2005–2006, 100 percent marking of spring- and fall-run Chinook began. By 2009–2010 the entire cohort of spawning salmon will be thermally marked (ages 2 through 5 years) and otolith analysis will begin. With the continuation of this program DWR will be able to definitively determine the origin and the proportions of spring- and fall-run within the river and the hatchery. With known origin and race, more advanced otolith analyzing techniques can be employed to investigate potential differences in life history strategy for fall- and spring-run, as well as hatchery and naturally produced Chinook. This will provide valuable information to evaluate the effectiveness of past management decisions aimed at the recovery of natural-origin Chinook and guide future restoration actions.

### Pelagic Organism Decline in the Upper San Francisco Estuary

By the early 2000s, long-term monitoring by the Interagency Ecological Program (IEP) had revealed marked declines in numerous pelagic (open water) fishes in the upper San Francisco Estuary (the Delta and Suisun Bay). This decline has collectively become known as the Pelagic Organism Decline (POD).

Since 2005, IEP scientists have been coordinating studies investigating potential causes of POD. Initial research efforts identified possible stressors on fish populations and mechanisms for population declines (see Bulletin 132-06).



In 2007, abundance indices calculated from several IEP monitoring programs continued to indicate record and near-record lows for resident pelagic fishes of the upper estuary, including delta smelt, longfin smelt, striped bass, and threadfin shad. These declines had several significant management consequences, including limits to pumping to protect delta smelt. Research continued on a suite of studies to further evaluate and refine the four components of the basic POD conceptual model. A synthesis of results through 2007 highlighted new findings in the context of the conceptual model.

1. Previous abundance—Species that were previously able to recover from low adult abundance levels in pre-POD years now show limited resilience.
2. Habitat—Turbidity, salinity, and temperature are significant habitat characteristics for POD species. Additional factors such as contaminants and toxic algal blooms represent emerging issues for species such as delta smelt.
3. Top-down effects—Predation by striped bass and largemouth bass and entrainment by the CVP and SWP seem to be unlikely single causes of the POD. Salvage of pre-spawning delta smelt and longfin smelt may be influenced by reverse flows at Old and Middle rivers and turbidity as a trigger for upstream migration.
4. Bottom-up effects—The species composition of zooplankton has changed during recent years, perhaps affecting feeding success of the POD fishes. Studies underway are focusing on the availability and quality of introduced zooplankton as a food source.

The full report, *Pelagic Organism Decline Progress Report: 2007 Synthesis of Results*, is available from <http://www.water.ca.gov/iep/activities/research.cfm>.

Additional information can be found in the *Pelagic Fish Action Plan*, published in March 2007, available from the Delta Initiatives website at <http://www.water.ca.gov/deltainit>.

## Fish-Related Mitigation Projects

In 1986, DWR and DFG signed the Delta Pumping Plant Fish Protection Agreement (Delta Fish Agreement) to annually provide funds to offset direct losses of Chinook salmon, steelhead, and striped bass at Banks Pumping Plant. The Delta Fish Agreement is commonly referred to as the Four Pumps Agreement because it was adopted as part of the mitigation package for four additional pumps at the Banks Pumping Plant. Direct losses are defined as losses of fish that occur from the time fish are drawn into Clifton Court Forebay until the surviving fish are returned to the Delta. In principle, DFG and DWR intended this agreement to offset direct losses of all fish caused by the diversions of water by the pumping plant starting in 1986. However, at that time, information on impacts and measures to offset those impacts was sufficient only to deal with Chinook salmon, steelhead, and striped bass. The agreement allowed for addressing impacts on other fish species once impacts could be identified and measures could be developed that would offset such impacts.

The process which led to this agreement included an advisory committee of representatives from interest groups concerned with fish resources affected by the SWP, including but not limited to representatives of the SWP water contractors, sport and commercial fishing groups, and environmental groups. The agreement formalized the Delta Pumping Plant Fish Advisory Committee and outlined how project proposals would be reviewed and selected for funding.

The Delta Fish Agreement gives priority to mitigation measures for habitat restoration and other nonhatchery measures.

Under the agreement, DWR calculates fish loss as prescribed in the agreement, and approved mitigation projects earn fish mitigation credits to satisfy the fish loss mitigation provisions in the agreement. Mitigation is on a fish-for-fish basis.

The agreement provides for two funding components. One component is the Annual Mitigation Account for compensating the annual fish losses. It has no expiration date. The second is a \$15 million lump sum provided by DWR for additional projects to compensate for post-1986 losses. The agreement specifies that the \$15 million must be expended by December 29, 1996.

The Delta Fish Agreement has been amended three times:

- Amendment 1 (1996)—extended the period to expend the remaining \$9 million of the \$15 million to December 29, 2001;
- Amendment 2 (2001)—extended the period to expend the remaining \$5 million of the \$15 million to December 31, 2004; and
- Amendment 3 (2004)—extended the period to expend the remaining \$3.6 million of the \$15 million to December 31, 2007.

DWR and DFG work with the Fish Advisory Committee to review the success of the agreement in offsetting the direct effects of diversions by the Banks Pumping Plant. If warranted, the agreement can be renegotiated to fulfill SWP's responsibilities to compensate direct fish losses. The agreement requires DWR and DFG to conduct an annual review and provide the results in an report.

Since 1986, DWR has spent \$45 million on mitigation projects developed under the Delta Fish Agreement. Mitigation fund expenditures through December 31, 2007, were \$34.7 million for the Annual Mitigation Account and \$12.6 million for the \$15 million Lump Sum Account. Funds approved but unexpended from each account were \$10.7 million and \$2.3 million, respectively. The remaining funds are allocated for new or previously implemented, longer-term projects. Some of the mitigation projects initiated, approved, or implemented in association with the agreement and its amendments are shown in Table 3-1.

On May 7, 2007, DWR and DFG entered into a memorandum of understanding (MOU) in order to facilitate and expedite completion of the reinitiated ESA Section 7 consultation for the SWP and CVP long-term OCAP. In Paragraph 7 of the MOU, DWR and DFG agreed to begin negotiations to amend the Delta Fish Agreement for a fourth time to include additional fish species not previously covered, address indirect and direct losses of those fish species, and find methods to develop mitigation credits for such take.

The Delta Fish Agreement has been an effective tool in mitigating direct impacts and has offset more than 100 percent of the mitigation losses as determined by DFG for salmon (182 percent) and steelhead (126 percent) and approximately 99 percent for striped bass. The program is in a period of project maintenance and replacement as older mitigation projects end. Fish passage projects and migration flows and enhanced enforcement to protect spring-run Chinook salmon continue to be priority projects, as do natural production projects for steelhead.

**Table 3-1 Delta Fish Agreement Mitigation Projects Funded, Approved, or Implemented**

Project	Project Description	Project Location
<b>1986 Delta Fish Agreement</b>		
<b>San Joaquin River System</b>		
San Joaquin fish barrier, 1992–2009	Fish barrier to improve salmon spawning and rearing habitat and migration pathways in the San Joaquin Basin	San Joaquin River Georgiana Slough
San Joaquin tributary diversion fish screens	Two screens installed as part of the San Joaquin River tributary diversion fish screening pilot project	Merced River
Merced River salmon habitat enhancement program	Gravel replacement and maintenance projects to provide benefits to fall-run salmon and steelhead; spawning and rearing habitat improvement; fish passage improvement; elimination of salmonid predator habitat; and improved channel, floodplain, and riparian areas	Merced River
Merced River hyacinth control	Pilot water hyacinth eradication project	Merced River
Merced River fish facility expansion	Expanding the fish facility to increase salmon production and cost-sharing in annual operating costs	Merced River
Spring-run salmon increased protection	Enhancing the enforcement of fish and game laws in the Delta and upstream to benefit salmon, steelhead, and striped bass, as well as increasing protection for spring-run Chinook salmon	various
<b>Bay-Delta</b>		
Striped bass stocking and net pen rearing	Planting hatchery-reared and net-pen-reared striped bass	Bay-Delta
Salmon acclimation pens	Operating an acclimation pen to improve the survival of hatchery-reared salmon during their release	San Pablo Bay
Delta-Bay Enhanced Enforcement Program (DBEEP)	Enhancing enforcement of fish and game laws in the Delta and upstream to benefit salmon, steelhead, and striped bass	Bay-Delta and upstream into the Sacramento and San Joaquin river basins
Grizzly Island fish screen	Constructing fish screen	Suisun Marsh
Suisun Marsh fish screens	Screening diversions in Suisun Marsh	Suisun Marsh
<b>Sacramento River System</b>		
Feather River salmon projects	Hatchery expansion; salmon passage	Feather River
Sacramento River spawning gravel	Gravel replacement and maintenance for salmon and steelhead	Sacramento River
Mill Creek spawning gravel	Gravel replacement and maintenance for salmon and steelhead	Mill Creek
Mill Creek water exchange project	Implementing a conjunctive-use project to improve salmon migration flows	Mill Creek and Deer Creek
Spring-run salmon passage projects	Constructing fish ladders and screens	Butte Creek
<b>1996 Amendment</b>		
<b>San Joaquin River System</b>		
San Joaquin tributary diversion fish screens	Screening diversions on the San Joaquin River tributaries	Merced River
San Joaquin salmon predator isolation	Predator isolation projects on San Joaquin River tributaries	various
<b>Sacramento River System</b>		
Spring-run salmon migration	Conjunctive-use project to improve spring-run salmon migration	Deer Creek

**Table 3-1 Delta Fish Agreement Mitigation Projects Funded, Approved, or Implemented**

Project	Project Description	Project Location
<b>2001 Amendment</b>		
<b>San Joaquin River System</b>		
Merced River salmon habitat enhancement project	Gravel replacement and maintenance projects to provide benefits to fall-run salmon and steelhead; spawning and rearing habitat improvement; fish passage improvement; elimination of salmonid predator habitat; and improved channel, floodplain, and riparian areas	Merced River
Salmon spawning habitat and channel restoration projects	Gravel augmentation, rehabilitation of spawning riffles, floodplain and channel rehabilitation	Tuolumne River
Stanislaus River salmon and steelhead habitat	Gravel replacement and maintenance to provide benefits to fall-run Chinook salmon and steelhead	Stanislaus River
Merced River wing deflector gravel	Salmon spawning gravel replenishment at wing deflector site	Merced River
<b>Sacramento River System</b>		
Spring-run salmon migration	Revised conjunctive-use project to improve spring-run salmon migration	Deer Creek
<b>2004 Amendment</b>		
<b>San Joaquin River System</b>		
Merced River fish facility operations and maintenance	Augmentation of the Delta Fish Agreement annual funding due to increased operating costs	Merced River
Merced River salmon habitat enhancement project—Robinson reach	Post-construction activities related to permit compliance and cost-share requirements	Merced River
Expansion of the Robinson reach conservation easement (Merced River salmon habitat enhancement project)	Placement of conservation easements on nearly 9,000 acres at the confluence of the Merced and San Joaquin rivers, covering approximately 5 miles of riparian habitat	Merced River
Merced River salmon habitat enhancement project	Complete design scenarios for additional phases of the project	Merced River
Stanislaus River salmon habitat	Increasing and improving spawning and rearing habitat for Chinook salmon and steelhead	Stanislaus River
<b>Sacramento River System</b>		
Deer Creek water exchange (operations and maintenance)	Groundwater exchange project designed to fulfill the water needs of local agricultural and domestic water users while achieving the fisheries flow objectives for salmon and steelhead	Deer Creek
<b>Bay-Delta</b>		
Delta-Bay Enhanced Enforcement Program (DBEEP)	Additional funding for focused enforcement efforts to protect anadromous species of concern in the Delta and upstream areas	Bay-Delta and upstream into the Sacramento and San Joaquin river basins
Suisun Marsh fish screens	Operation and maintenance of 14 fish screens in Suisun Marsh over a 12-year period	Suisun Marsh



## **Chapter 4**

# **Water Quality Programs**

*Sisk Dam, San Luis Reservoir.*

## Significant Events in 2007

In September 2007, the Regional Water Control Board identified and amended the Water Quality Control Plan for the Sacramento River and San Joaquin River basins for pH and turbidity objectives to protect beneficial uses.

The Sacramento Valley Water Year Hydrologic Classification (40-30-30 Index) was dry. The San Joaquin Valley Water Year Hydrologic Classification (60-20-20 Index) was critical.

The State Water Resources Control Board convened a number of workshops to receive input and conduct detailed discussions related to the Pelagic Organism Decline (POD) in the Bay-Delta. The goal of the workshops was to collect information that might be used in updating the current Bay-Delta Plan. Following the workshops, SWRCB would determine whether there was adequate justification to convene proceedings to update the Bay-Delta Plan using the collected information.

*Information in this chapter was contributed by the Division of Environmental Services and the Division of Operations and Maintenance.*

The State Water Project (SWP) is the largest State-built, multipurpose water project in the United States. California's existence and continued prosperity depends on water. More than two-thirds of the people of California rely partly or wholly on the SWP for their daily water needs. The Department of Water Resources (DWR), Division of Operations and Maintenance currently maintains 15 automated water quality monitoring stations at key locations along the SWP. This network of automated stations continuously monitors a variety of water quality parameters throughout the system and provides real-time data to SWP water contractors. In addition, field grab samples collected weekly, monthly, quarterly, or annually from more than 30 SWP locations are routinely analyzed for a broad range of constituents at the State's Bryte Chemical Laboratory.

## Delta Activities

The State Water Resources Control Board (SWRCB) establishes water quality objectives and monitoring plans to protect a variety of the beneficial uses of water. The water quality objectives are set at points of delivery under Article 19 of the long-term SWP water supply contracts. The California Department of Public Health (DPH) establishes maximum contaminant levels for treated drinking water.

Water quality in the Delta and Suisun Marsh is protected under SWRCB's Water Right Decision 1641 (D-1641), adopted in December 1999 (see the sidebar, State Water Resources Control Board). SWRCB's issuance of D-1641 is part of its implementation of the 1995 *Water Quality Control Plan (WQCP) for the San Francisco Bay/Sacramento-San Joaquin Delta Estuary* (Bay-Delta Plan) and, accordingly, this decision amends certain water rights of the water rights holders to help achieve the plan's objectives. The SWRCB ensures that these objectives are met in part by the inclusion of water quality monitoring requirements in D-1641 as conditions for operating the SWP and Central Valley Project (CVP).

DWR conducts extensive monitoring to protect beneficial uses of water in the Delta and Suisun Marsh, as required by D-1641. Figure 4-1 shows water quality compliance

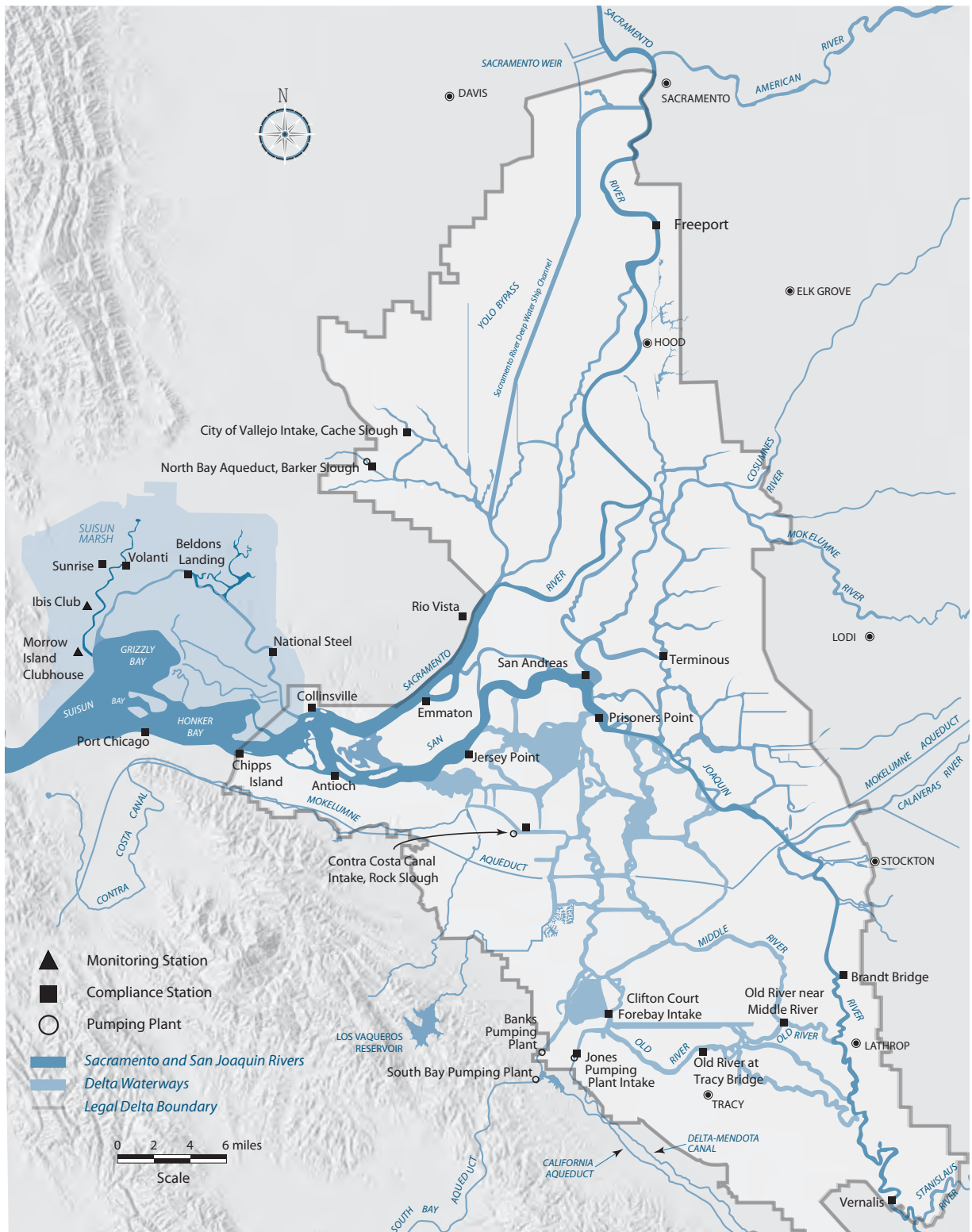
and monitoring stations throughout the Sacramento-San Joaquin Delta required by D-1641.

## Water Supply Conditions

### Water Year Classifications and Water Supply Indexes

SWRCB's D-1641 contains water quality and flow standards that are conditioned by water year type and generally become less stringent in years with less precipitation. The water year classification system provides relative estimates of a basin's available water supply based on the amounts of rainfall, snowmelt runoff, and groundwater accretion rates. Water year types are classified as "wet," "above normal," "below normal," "dry," or "critical."

The Sacramento Valley Water Year Hydrologic Classification (40-30-30 Index) and the San Joaquin Valley Water Year Hydrologic Classification (60-20-20 Index) were dry and critical, respectively, based on observed data for water year 2006–2007. (For a detailed discussion of water year 2006–2007, see Chapter 8, Water Supply.)



**Figure 4-1 Decision 1641 Water Quality Compliance and Monitoring Stations in the Sacramento-San Joaquin Delta**



## Operations under State Water Resources Control Board Water Right Decision 1641

In 2007, DWR and the Bureau of Reclamation (Reclamation) jointly operated the SWP and CVP in accordance with SWRCB's D-1641 which includes water quality, flow, and operational criteria for the Delta. Operations of the projects were coordinated with various objectives of the Bay-Delta Plan, Central Valley Project Improvement Act, and biological opinions for listed species.

As mentioned above, the water quality and flow criteria contained within D-1641 are conditioned by water year type. Specifically, the Sacramento Valley 40-30-30 Index water year type forecast on May 1 of each year determines the water year type for the implementation of flow and water quality criteria contained within D-1641. In 2007, the SWP and CVP were operated using water quality and flow criteria based on the May 1 forecast of dry for the Sacramento River Basin and critical for the San Joaquin River.

CALFED's Record of Decision mandates an Environmental Water Account (EWA) managed by DWR, Reclamation, the Department of Fish and Game (DFG), U.S. Fish and Wildlife Service (USFWS), and National Marine Fisheries Service (NOAA Fisheries) for the protection of listed fish species. Fish species currently listed under ESA and CESA include the winter and spring runs of Chinook salmon, delta smelt, steelhead, and green sturgeon.

Real-time monitoring of fish movement and conditions in the estuary aids daily water management and provides timely protection of targeted fish species from entrainment at the Delta pumping facilities. (See Chapter 3, Environmental Programs, for a discussion of other environmental issues.)

## Delta Cross Channel Gates

The Delta Cross Channel gates are operated in accordance with SWRCB D-1641. In 2007, the gates were open for 196 days to allow fresher Sacramento River water to flow into interior Delta channels toward the SWP and CVP export facilities. Reclamation's standard operating procedures call for gate closure when flow on the Sacramento River at Freeport reaches between 20,000 cubic feet per second (cfs) and 25,000 cfs to reduce flooding potential on the Mokelumne River and to prevent scouring on the downstream side of the gate structure. D-1641 contains measures that require gate closure under certain conditions from November 1 through May 20 for fisheries protection as requested by USFWS, NOAA Fisheries, and DFG.

## Water Quality Standards

Water quality objectives in D-1641 are categorized by the beneficial uses they are intended to protect, including municipal, industrial, agricultural, and fish and wildlife. DWR operators adjust upstream releases and Delta exports in order to meet D-1641 water quality and flow standards. D-1641 contains salinity standards (recorded as electrical conductivity [EC]) for three stations in the South Delta downstream of Vernalis. The stations are primarily influenced by San Joaquin River flow and in Delta diversions. San Joaquin River flows are not influenced by SWP upstream reservoirs, but local water levels may be influenced by SWP exports and circulation may be influenced by the annual placement of South Delta barriers.

## Municipal and Industrial Objectives

D-1641 includes a year-round 250 milligrams per liter (mg/L) (maximum mean daily) chloride objective that is in effect at Delta export locations (Contra Costa Canal Pumping Plant No. 1, Clifton Court Forebay, Jones Pumping Plant, Cache Slough at the City of Vallejo Intake, and Barker Slough). Chloride levels remained below the objective throughout 2007.

## State Water Resources Control Board

The State Water Resources Control Board (SWRCB), established by the California Legislature in 1967, protects water rights and water quality by setting statewide policy, overseeing appropriative water rights, coordinating with and supporting Regional Water Quality Control Board (RWQCB) efforts, and reviewing petitions that contest RWQCB actions. The five SWRCB members are appointed by the Governor and confirmed by the Senate. Each member fills a different specialized position. SWRCB is responsible for four major programs.

- Water quality: In cooperation with RWQCB, to preserve, protect, enhance, and restore water quality.
- Water rights: SWRCB issues permits for water rights specifying amounts, conditions, and construction timetables for diversion and storage.
- Financial assistance: SWRCB has several financial programs to assist local agencies and individuals prevent or clean up pollution of the State's water. These include loans and grants for constructing municipal sewage and water recycling facilities.
- Enforcement: SWRCB and its nine RWQCBs are responsible for enacting enforcement when the laws and regulations protecting our waterways are violated.

Under their water quality authority, SWRCB and RWQCBs adopt water quality control plans (WQCPs) for the 16 planning basins in the State. The WQCPs contain water quality objectives for flow, salinity, dissolved oxygen (DO) levels, and other parameters necessary for the protection of various beneficial uses, such as municipal and industrial, agricultural, and fish and wildlife. SWRCB implements these objectives in a number of ways, depending on the circumstances, including imposing conditions on water right permits and licenses. Current water quality objectives for the San Francisco Bay/Sacramento-San Joaquin Delta Estuary (Bay-Delta Estuary) and Suisun Marsh are contained in the *Water Quality Control Plan for the San Francisco Bay/Sacramento-San Joaquin Delta Estuary*, dated December 13, 2006 (Bay-Delta Plan, 2006).

The first major decision allocating primary responsibility to the State Water Project (SWP) and Central Valley Project (CVP) for meeting Delta water quality objectives was issued by SWRCB in 1978 in the *Water Right Decision 1485 (D-1485): Sacramento-San Joaquin Delta and Suisun Marsh*, which also implemented the WQCP for the Delta and Suisun Marsh. A stated purpose of D-1485 was to protect water quality at least to levels that existed without the SWP and CVP. D-1485 affected DWR and Bureau of Reclamation (Reclamation) water rights permits by placing the entire burden of meeting the Delta water quality and flow objectives on the SWP and CVP. Following its adoption, D-1485 was challenged in court by various water users and the federal government. The decision in that case (Racanelli Decision) criticized a number of the fundamental principles within D-1485, including combining the water rights and water quality functions in one proceeding and limiting the evaluation of objectives and responsibilities to the SWP and CVP impacts and operations alone.

(continued)

The SWRCB held a series of workshops and hearings beginning in March 1994 to revise the water quality objectives. The SWRCB urged interested parties to negotiate to develop alternatives for revising the objectives. These negotiations resulted in the Principles for Agreement on Bay Delta Standards (December 15, 1994). On February 28, 1995, Reclamation and DWR filed a petition with SWRCB to change their water rights to conform to the Principles for Agreement. SWRCB issued a notice of public hearing for April 18, 1995, regarding the establishment of appropriate objectives to protect the beneficial uses of the Bay-Delta Estuary. SWRCB adopted an updated *WQCP for the San Francisco Bay/Sacramento-San Joaquin Delta Estuary* (1995 Bay-Delta Plan) on May 22, 1995 which included many elements of the Principles for Agreement. Elements of the 1995 Bay-Delta Plan include water quality objectives and flow objectives in the Delta, objectives for the Suisun Marsh, and salinity control actions in the San Joaquin Basin. Certain objectives in the updated plan conflicted with those in D-1485. Water Rights Order WR 95-06 was adopted on June 8, 1995. This order amended certain portions of D-1485 to conform to the objectives in the 1995 Bay-Delta Plan. It also provided that both the SWP and CVP could use either agency Delta pumping plant to divert project water in order to increase fish protection and maintain project delivery capability (referred to as Joint Point operations). WR 95-06 had a term of only 3 years, the time estimated for completion of the Bay-Delta proceedings and adoption of a comprehensive new water rights decision. The water rights proceedings extended beyond the 3-year estimate, and SWRCB adopted WR 98-09 on December 3, 1998, to extend the terms and conditions of WR 95-06. On December 29, 1999 (Revised March 15, 2000), SWRCB adopted Decision 1641 (D-1641). The CVP and SWP agreed to meet standards in Order WR 95-06 until SWRCB adopted a new comprehensive water right decision.

In December 1995, SWRCB released a revised Notice of Preparation describing a preliminary set of alternative approaches to achieve the requirements of the 1995 Bay-Delta Plan. The SWRCB held public workshops and, on September 12, 1996, released a summary of alternatives under consideration in the Bay-Delta Plan draft environmental impact report (EIR). The summary covered the alternatives under analysis and the assumptions SWRCB was making in order to model the alternatives.

On December 2, 1997, SWRCB released the draft EIR associated with implementing the requirements of the 1995 Bay-Delta Plan. SWRCB evaluated seven alternative methods of allocating responsibility for meeting flow objectives contained in the 1995 Bay-Delta Plan.

In July 1998 SWRCB convened a series of Bay-Delta water rights hearings to consider the assignment of responsibility among water right holders to implement the flow-dependent objectives in the 1995 Bay-Delta Plan.

SWRCB divided the hearing into eight phases, with each phase focusing on a particular subject or subjects. (See Bulletin 132-00, Chapter 7, for a summary of what each phase addressed.) Phases 1 through 7 were conducted July 1, 1998 through December 21, 1999. During that time, SWRCB certified the EIR for the 1995 Bay-Delta Plan (Resolution 99-117, November 1999). On December 29, 1999, SWRCB issued D-1641 on the subjects considered in the water rights hearing Phases 1 through 7. D-1641 replaced D-1485. D-1641 modified the water rights permits of a number of water districts, DWR, and Reclamation to implement the objectives contained in the 1995 Bay-Delta Plan.

(continued)

D-1641 also authorized the proposed joint points of diversion under CVP and SWP water rights, approved agreements among the parties allocating responsibility for meeting the flow-dependent objectives, contained changes in the responsibilities to meet Suisun Marsh objectives, and approved changes in place and purposes of use of certain CVP water right permits. D-1641 is the current water rights decision governing operations of the SWP and CVP. Primary responsibility for meeting the objectives in the 1995 Bay-Delta Plan remains with the SWP and CVP. (See Bulletin 132-01, Chapter 7, for a summary of the highlights of D-1641.) In March 2000 SWRCB amended D-1641 with WR 2000-02 to address issues raised by several parties related to D-1641.

The Bay-Delta water rights hearings were to resume in August 2000 to conduct Phase 8 to complete the assignment of the remaining responsibilities for meeting the flow-dependent objectives in the 1995 Bay-Delta Plan. However, after completion of the previous 7 phases of the hearing, parties subject to Phase 8 anticipated delays associated with resolving Phase 8 issues. The Upstream Water Users, USBR, DWR, and the Downstream Water Users recognized there would be institutional water quality benefits if parties subject to Phase 8 could provide a mechanism for satisfying existing Bay-Delta water quality and flow objectives by developing a cooperative water management partnership. With this goal, the parties signed the Agreement Regarding Resolution of Phase 8 Issues, Development and Management of Water Supplies, and Binding Commitment to Proceed Pursuant of Specified Terms, known as the Stay Agreement (April 3, 2001). The Stay Agreement proposed goals and principles to resolve issues of the flow-related standards that would have been the subject of Phase 8. The agreement includes a commitment by USBR and DWR to meet the objectives required under D-1641 so long as the agreement remains in effect and for a year thereafter. Phase 8 was later dismissed by SWRCB (WR 2001-05, adopted April 26, 2001, and WR 2002-12, adopted October 17, 2002) after the remaining responsibilities to meet the flow-dependent objectives were resolved through a negotiated agreement known as the Sacramento Valley Water Management Agreement, signed in March 2003 (see Chapter 7). (See the discussion of Phase 8 in Bulletin 132-03, Chapter 7.)

In January 2004 SWRCB began its periodic review of the 1995 Bay-Delta Plan and conducted a series of workshops in 2004 and 2005 to obtain information on specific topics addressed in the plan. SWRCB commenced proceedings in September 2006 to amend the 1995 Bay-Delta Plan. The 2006 WQCP (2006 Bay-Delta Plan) was adopted December 13, 2006 (Resolution No. 2006-0098). The 2006 Bay-Delta Plan was approved by the State Office of Administrative Law on June 27, 2007.

An additional municipal and industrial water quality objective for chloride at the Contra Costa Canal Intake, near Rock Slough, specifies that the chloride level must be below 150 mg/L for a given number of days during the year, dependent upon the water year forecast.

### **Agricultural Objectives**

D-1641 contains agricultural salinity objectives, which varies by location. The salinity objectives, recorded as EC, are based on both water year type and a 14-day running average during the irrigation season, from April to mid-August, at Emmaton, Jersey Point, Terminous, and San Andreas

in the western and central Delta. The agricultural salinity objectives at these Delta locations becomes less stringent under dryer conditions. Emmaton and Jersey Point met the objective in 2007. (Data for Terminous and San Andreas were not available.)

In the south Delta, the salinity objectives are based on a 30-day running average. The 0.7 millisiemens per centimeter (mS/cm) objective for the South Delta was not met at Brandt Bridge, Old River, and Middle River. The SWP and CVP are jointly required by D-1641 to meet the agricultural EC objective imposed at these South Delta compliance locations. (See also, Chapters 2 and 7.)

## Estuarine Habitat Protection Standard

The estuarine habitat protection standard incorporates modified X2 criteria (geographic isohaline) first established in the 1994 delta smelt biological opinion (BO). The upstream movement of 2 ppt isohaline (2 parts per thousand of salt in the water), measured as 2.64 mS/cm at the surface, is maintained within a certain range of positions in the estuary by adequate Delta outflow. These positions (Collinsville, Chipps Island, Port Chicago, or Martinez) are associated with an abundance of fish and biota.

The requirement for meeting X2 criteria at Collinsville applies to all the days during the months of February through June. The number of days per month when the daily averaged EC maximum (2.64 mS/cm) is in effect at Chipps Island or Port Chicago is conditioned by the previous month's Eight River Index. This may alternately be met with a maximum 14-day running average EC of 2.64 mS/cm or with specific Delta outflow, set as a 3-day average Net Delta Outflow Index (NDOI) of 7,100 cfs, 11,400 cfs, or 29,200 cfs, when the X2 position is at Collinsville, Chipps Island, or Port Chicago, respectively. The Port Chicago standard becomes effective when the Port Chicago 14-day EC average, immediately prior to the

first day of the month, is less than or equal to 2.64 mS/cm.

The Eight River Index, from January through May 2007, in million acre feet (maf), was 0.85, 2.14, 2.06, 1.73, and 1.67, respectively. The X2 habitat protection objective at Chipps Island was required and met for 11 days in February, 31 days for March, and 25 days in April.

Additionally in 2007, the X2 habitat protection objective at Port Chicago was triggered for the month of March only with 16 days required and met for this period.

## Net Delta Outflow Index Standard

Delta outflow cannot be measured directly due to the tidal influence in the Delta. Instead, an approximation of Delta outflow is calculated using measured inflows, exports, and estimated Delta water use. The NDOI was introduced in the 1995 Bay-Delta Plan and is now part of D-1641. NDOI calculates Delta outflow using inflows of the Sacramento River, the Yolo Bypass system, the eastside stream system (consisting of the Mokelumne, Cosumnes, and Calaveras rivers), the Sacramento Regional Treatment Plant, and a measurement of San Joaquin River flow at Vernalis.

Excess outflow conditions, as defined by the Coordinated Operations Agreement, allow for greater flexibility in project operations. During 2007, Delta water conditions began and ended in excess, totaling an accumulated 150 days.

D-1641 sets specific minimum monthly NDOI standards, for the protection of fish and wildlife, based on water year type. In 2007, the monthly mean NDOI was highest in February, averaging 21,700 cfs. The monthly mean NDOI remained above 4,000 cfs during all months of the year, with the lowest monthly mean NDOI occurring in October, with 4,036 cfs. All NDOI standards were met in 2007.

## River Flow Standards

D-1641 includes minimum flow requirements measured in the Sacramento River at Rio Vista. These flow standards, incorporated from the winter-run salmon BO, set flow requirements based on the May 1 Sacramento Valley water year classification forecast. Water year 2006-2007 was forecast to be dry, requiring mean monthly flows of 3,000 cfs for September, 4,000 cfs for October, and 4,500 cfs for November and December. During these periods, the 7-day running average could not be more than 1,000 cfs below the monthly standard. The actual mean monthly flows were 8,833 cfs for September, 5,381 cfs for October, 4,924 cfs for November and 6,742 cfs for December, meeting all Rio Vista flow objectives in 2007.

If the X2 objective is required to be at or west of the Chipps Island location, dry year base Vernalis flows are set at 2,280 cfs from February to April 14 and from May 16 through June 30. The base flow objective is relaxed to 1,420 cfs when X2 is required to be east of Chipps Island.

D-1641 requires the San Joaquin River spring pulse flow for April 15 to May 15 at Vernalis. This spring pulse flow requirement varies based on the location of X2 during April. However, the CALFED Operations Group may vary the actual timing and duration of the pulse attraction flow based on real-time monitoring data. The *Vernalis Adaptive Management Plan* (VAMP), part of the San Joaquin River Agreement and approved in D-1641, contains SWRCB-approved alternate spring pulse flow and export limits. Typically, Reclamation and DWR use this alternate in lieu of D-1641 limits. The pulse flow objective for the spring 2007 VAMP period was 3,200 cfs. The San Joaquin Valley water year type was critical, therefore VAMP was a single-step operation, with no fall pulse flow.

## Export Standards

D-1641 includes an export limitation for the SWP and CVP. It limits Delta exports to a ratio of Delta inflow to combined water project exports and is expressed as a maximum export rate in percentage of Delta inflow. The maximum percentage of Delta inflow diverted varies by month; for example, in February, it is conditioned by the previous month's Eight River Index. During the San Joaquin River spring pulse flow season, VAMP export rates are typically used as an alternative to the D-1641 spring export limitation, and the CALFED Operations Group may impose additional export restrictions.

The actual export amount is calculated using the 3-day average that combines the inflow rate for Clifton Court Forebay (excluding Byron-Bethany Irrigation District diversions from Clifton Court Forebay) added to the Jones Pumping Plant diversion. The export-to-inflow ratio limit is reported as either a 3-day or 14-day running average. A 14-day running average of inflows is used unless storage withdrawals from upstream reservoirs are being made for export, in which case a 3-day average of inflows is used. In all water year types, the maximum combined export rate from February through June is 35 percent of Delta inflow. This rate may be relaxed in February, during years with less precipitation, to between 35 and 45 percent. From July through January, the export-to-inflow ratio rises to 65 percent.

During January 2007, combined SWP and CVP exports averaged about 44.5 percent of Delta inflow, meeting the 65 percent limitation.

During the more restrictive period from February through June (35 percent objective), exports averaged about 22 percent.

From July through the following January, the SWP and CVP exported about 49 percent,

16 percent less than the allowed 65 percent. From July through December 2007, the combined inflow diverted averaged 53 percent.

## South Delta Temporary Barriers

The South Delta Temporary Barriers Project, initiated as a test project in 1991, was extended for 5 years in 1996, and extended again for 7 years in 2001. The project was created partially in response to a 1982 lawsuit filed by the South Delta Water Agency and consists of four rock barriers across South Delta channels.

These temporary seasonal barriers are designed to improve local water levels and circulation patterns, protect fishery resources, and improve water quality. They are placed across Middle River, Old River near Tracy, Grant Line Canal, and at Head of Old River. Additional background information can be found in Chapter 2, Delta Resources.

The installation of the Middle River barrier was completed on April 10, 2007, and the Old River barrier near Tracy installation was completed on April 23. The spring barrier at Head of Old River, which functions as part of VAMP, was installed in April (installation completed April 26). The Grant Line Canal barrier was partially installed by April 17, with the installation completed on May 11. The Middle River barrier was notched on September 21, and removal was completed by November 29. Removal of the Old River near Tracy barrier and the Grant Line Canal barrier was completed on November 18 and 29, 2007, respectively.

The barrier placed at Head of Old River in the fall, which helps keep upstream migrating adult salmon from straying out of the San Joaquin River into interior Delta channels, can help improve dissolved oxygen (DO)

conditions in the Stockton Ship Channel. The Head of Old River barrier installation was completed October 18, and removal was completed November 29.

## Special Study and Biological Surveys

DWR conducts several special studies and biological surveys each year. This includes a special study in the Stockton Ship Channel during the late summer and early fall to monitor the occurrence of low DO levels. Low DO levels can potentially cause physiological stress to fish and block the migration of salmon into the San Joaquin River. DWR also conducts biological surveys of benthic organism density and diversity, and of phytoplankton biomass and community composition in the Sacramento-San Joaquin Delta, Suisun Bay, and San Pablo Bay.

## Fall Dissolved Oxygen Study in the Stockton Ship Channel

Historically, during the late summer and early fall, DO levels in the eastern and central portions of the Stockton Ship Channel have dropped below both the 5.0 mg/L and 6.0 mg/L water quality objectives set by SWRCB and the RWQCB, respectively. These low DO levels are a result of several factors, including low San Joaquin River inflows, warm water temperatures, high biochemical oxygen demand, reduced tidal circulation, and intermittent reverse flow conditions in the San Joaquin River at Stockton.

To help reduce the severity of these low DO conditions, DWR normally installs a temporary rock barrier across the Head of Old River during periods of projected low fall flows in the San Joaquin River. The barrier increases net flows in the San Joaquin River past Stockton by reducing the upstream diversion of flows down Old River.

Head of Old River barrier construction began on October 8 and was completed on October 18. Barrier removal began on November 9 and was completed on November 29.

### Methods

Monitoring of DO concentration in the Stockton Ship Channel was conducted by boat on 13 monitoring runs, from June 15 to December 12, 2007. During each run, 14 sites were sampled at low water slack tide from Prisoners Point in the Central Delta to the Stockton Turning Basin at the terminus of the ship channel. Because monitoring results differ within the channel, sampling stations were grouped into western, central, and eastern regions. The findings of previous fall studies have shown that fall DO levels are typically robust and high (7.0 to 9.0 mg/L) in the western channel; transitional, variable (4.0 to 7.0 mg/L), and stratified in the central channel; and low (3.0 to 5.0 mg/L) and stratified in the eastern channel. The western channel begins at Prisoners Point and ends at Columbia Cut. The central channel begins one-half mile east of Columbia Cut and ends at Fourteen Mile Slough. Finally, the eastern channel begins at Buckley Cove and ends at Rough and Ready Island. The turning basin is unique within the channel because it is east of the entry point of the San Joaquin River into the channel and isolated from down-channel flows.

### Results

During the period of this study (June 15 to December 12), DO levels varied significantly within the channel (not including the turning basin) from a low of 4.2 mg/L to a high of 10.2 mg/L. In the western channel, DO concentrations were relatively high and stable, ranging from 6.9 to 10.1 mg/L. In the central channel, DO concentrations were variable, ranging from 4.5 to 10.2 mg/L. In the eastern channel, DO levels were the lowest, ranging from a low of 4.2 mg/L to a high of 10.2 mg/L.

DO concentrations in the Stockton Ship Channel fell below both the State's 5.0 mg/L and 6.0 mg/L objectives during June (stations 8 through 12), July (stations 8 through 12), August (stations 9 through 12), and September (stations 8 through 11 and station 13). All sites were above State DO objectives on subsequent sampling runs.

Higher San Joaquin River inflows, as well as the absence of intermittent reverse flows near Stockton, coincided with improved DO conditions. Further monitoring operations for the fall special study were suspended after December 12, 2007.

### Benthic Survey

The benthic monitoring program documents changes in the composition, abundance, density, and distribution of the benthic biota within the upper San Francisco Estuary. Benthic biota are relatively long-lived and can respond to changes in physical factors within the estuary, such as fresh water inflows, salinity, and substrate composition. As a result, benthic data can provide an indication of physical changes occurring within the upper estuary. Because the operation of the SWP can impact flow characteristics of the estuary, and subsequently influence the density and distribution of benthic biota, benthic monitoring is an important biological survey conducted by DWR. In addition, benthic monitoring data are also used to detect and document the presence of newly introduced species within the upper estuary.

Benthic monitoring was conducted at 10 sampling sites distributed throughout the major habitat types within the estuary:

- Clifton Court Forebay Intake;
- San Joaquin River at Buckley Cove;
- San Joaquin River at Twitchell Island;
- Old River opposite Rancho Del Rio;
- Sacramento River below the Rio Vista Bridge;



- Sacramento River above Point Sacramento;
- Suisun Bay at Bulls Head;
- Grizzly Bay at Dolphin near Suisun Slough;
- San Pablo Bay near Pinole Point; and
- San Pablo Bay near the mouth of the Petaluma River.

Four bottom grab samples for benthic analysis and one sample for sediment analysis were collected monthly at each site during 2007. Samples were analyzed to identify organisms to the lowest possible identifiable taxon and to count all organisms collected.

DWR maintains a database of benthic organisms located within the upper estuary. The benthic database is dynamic and regularly undergoes peer review and update. When a new organism is identified at any of the sampling stations it is added to the database. In addition, the taxonomic names of organisms on the list are updated when sufficient evidence is produced to warrant such changes.

A total of 174 species of benthic macrofauna were collected in 2007 at the 10 sampling sites. Of the 174 species, the following 10 species represented 84.6 percent of all organisms collected:

- the amphipods: *Ampelisca abdita*, *Americorophium spinicorne*, *Corophium alienense*, *Gammarus daiberi* and *Americorophium stimpsoni*;
- the sabellid polychaete: *Manayunkia speciosa*;
- the turbidicid worms: *Varichaetadrilus augustipenis* and *Limnodrilus hoffmeisteri*; and
- the Asian clams: *Corbula amurensis* and *Corbicula fluminea*.

Of the 10 dominant species, *Corbula amurensis* and *Ampelisca abdita* represent

macrofauna that inhabit a typically higher saline environment and were found in San Pablo Bay, Suisun Bay, and Grizzly Bay. *Corophium alienense*, *Americorophium stimpsoni*, *Americorophium spinicorne*, and *Limnodrilus hoffmeisteri*, tolerate a wider range of salinity. They were collected both in the higher saline western sites and the more brackish to fresh water eastern sites such as the San Joaquin River at Twitchell Island and the Sacramento River above Point Sacramento. The remaining four species, *Gammarus daiberi*, *Varichaetadrilus augustipenis*, *Manayunkia speciosa*, and *Corbicula fluminea* are predominantly fresh water species and were collected at sites east of Suisun Bay.

## Phytoplankton and Chlorophyll *a* Survey

Phytoplankton are small, free-floating or attached algae that can be tiny, single-celled organisms (less than 5 micrometers [ $\mu\text{m}$ ] in diameter) or larger colonial organisms. Phytoplankton are an important source of food in the estuary for zooplankton, invertebrates, and some species of fish. Phytoplankton biomass is an indicator of the status of primary productivity in the estuary. Chlorophyll *a* is one of the main groups of pigments contained in the algal species that make up phytoplankton.

Monthly sampling of chlorophyll *a* concentrations and phytoplankton was conducted in 2007 by DWR's Bay-Delta Monitoring Branch at 13 stations throughout the upper San Francisco Estuary:

- Sacramento River at Greene's Landing/Hood and above Point Sacramento;
- San Joaquin River at Vernalis, Buckley Cove, and Potato Point;
- Old River opposite Rancho Del Rio;
- Disappointment Slough near Bishop Cut;
- Frank's Tract near Russo's Landing;
- Suisun Bay at Bull's Head near Martinez and off Middle Point near Nichols;

- Grizzly Bay at Dolphin near Suisun Slough; and
- San Pablo Bay near Pinole Point and near the mouth of the Petaluma River.

Chlorophyll *a* concentration was measured at the 13 monitoring stations to estimate overall phytoplankton biomass in the estuary. Phytoplankton samples were collected and analyzed separately to determine which species were present in the estuary.

Monthly chlorophyll *a* concentrations throughout much of the estuary were relatively low when compared to historical data. Of the 156 samples taken in 2007, 91.0 percent had chlorophyll *a* levels below 10 micrograms per liter ( $\mu\text{g/L}$ ). Chlorophyll *a* levels below 10  $\mu\text{g/L}$  are considered limiting for zooplankton growth. The mean chlorophyll *a* concentration for all samples in 2007 was 5.48  $\mu\text{g/L}$ , and the median value was 1.79  $\mu\text{g/L}$ . In 2006, mean chlorophyll *a* concentrations were lower, with a mean of 3.58  $\mu\text{g/L}$  and a median of 2.06  $\mu\text{g/L}$ . The maximum chlorophyll *a* concentration in 2007 was 108.00  $\mu\text{g/L}$ , recorded in August at the San Joaquin River at Vernalis. This maximum was higher than the 2006 peak of 32.90  $\mu\text{g/L}$ . The minimum chlorophyll *a* concentration in 2007 was 0.25  $\mu\text{g/L}$ , recorded in November at the Sacramento River above Point Sacramento.

The samples with chlorophyll *a* levels above 10  $\mu\text{g/L}$  were all measured in the San Joaquin River at Vernalis, Buckley Cove, and Disappointment Slough near Bishop Cut. These monitoring sites, plus the monitoring sites in San Pablo Bay near Pinole Point and near the mouth of the Petaluma River, had the highest chlorophyll *a* concentrations measured in 2006.

Phytoplankton biomass and resulting chlorophyll *a* concentrations in some areas of the estuary may be influenced by extensive filtration of the water column by the

introduced Asian clam, *Corbula amurensis*. Well-established benthic populations of *C. amurensis* in Suisun and San Pablo bays are thought to have contributed to the low chlorophyll *a* concentrations (and increased water clarity) measured in these westerly bays since the mid-1980s.

In addition to monitoring for chlorophyll *a*, water samples were analyzed for pheophytin. Pheophytin *a* is a primary degradation product of chlorophyll *a*, and its relative concentration is useful for estimating the general physiological state of phytoplankton populations. When phytoplankton are actively growing, the concentrations of pheophytin are normally expected to be low in relation to chlorophyll *a*. The mean pheophytin *a* concentration for all samples in 2007 was 3.04  $\mu\text{g/L}$ , and the median value was 1.37  $\mu\text{g/L}$ . The maximum pheophytin *a* concentration was 39.90  $\mu\text{g/L}$ , recorded at Disappointment Slough near Bishop Cut in February. The minimum pheophytin *a* concentration was 0.27  $\mu\text{g/L}$ , recorded at the San Joaquin River at Potato Point in November.

Phytoplankton populations consisted of these categories (in order of abundance): centric diatoms (class Coscinodiscophyceae), Cyanobacteria (class Cyanophyceae), unidentified flagellates, green algae (classes Chlorophyceae, Ulvophyceae, and Zygnematophyceae), pennate diatoms (classes Bacillariophyceae and Fragilariophyceae), cryptomonads (class Cryptophyceae), euglenoids (class Euglenophyceae), haptophytes (class Prymnesiophyceae), chrysophytes (class Chrysophyceae), dinoflagellates (class Dinophyceae), and synurophytes (class Synurophyceae). Of the genera identified, the following were the 10 most common, in order of abundance: *Cyclotella*, unidentified flagellates, *Chroococcus*, *Aulacoseira*, unidentified centric diatoms, *Microcystis*, *Skeletonema*, *Monoraphidium*, *Planktosphaeria*, and *Achnanthes*.

**Table 4-1 O&M SWP Automated Water Quality Monitoring Stations and Test Parameters**

CDEC ID	Location	County	EC ( $\mu$ S/cm)	Temp C	Turbidity (NTU)	pH	Fluoro <sup>a</sup>	UVA- 254 <sup>b</sup>
BKS	Barker Slough Pumping Plant	Solano	x	x	x	x	-	-
C13	Check 13	Merced	x	x	x	x	-	x
C21	Check 21	Kings	x	x	x	-	-	-
C29	Check 29	Kern	x	x	x	-	-	-
C41	Check 41	Kern	x	x	x	x	-	-
C66	Check 66	San Bernardino	x	x	x	-	-	-
CLC	Clifton Court	Contra Costa	x	x	x	x	x	-
CPP	Cordelia Pumping Plant	Solano	x	x	x	-	-	-
CSO	Castaic Lake Outlet	Los Angeles	x	x	x	x	-	-
DCO	Del Valle Conservation Outlet Works	Alameda	x	x	x	x	-	-
DV7	Del Valle Check 7	Alameda	x	x	x	x	x	-
DVC	Devil Canyon Headworks	San Bernardino	x	x	x	-	-	-
EDP	Edmonston Pumping Plant	Kern	-	-	-	-	-	x
HBP	Banks Pumping Plant	Alameda	x	x	x	x	x	x
PPP	Pacheco Pumping Plant	Merced	x	x	x	-	x	-
VSF	Vallecitos Turn-Out	Alameda	x	x	x	x	-	-

<sup>a</sup>Fluoro = fluorometry (measures chlorophyll)

<sup>b</sup>UVA-254 = 254nm ultraviolet absorbance (measures dissolved organic carbon)

## Activities Outside the Delta

Routine SWP water quality monitoring activities, as well as special studies, are conducted outside the Delta. These special studies are in response to increasingly stringent regulations facing water purveyors who rely on DWR to deliver high quality raw water. Most of these special studies were initiated because of the fish and wildlife and water quality concerns held by agencies that provide domestic water.

## Water Quality Monitoring in the SWP

The DWR, Division of Operations and Maintenance (O&M) Water Quality Section monitors water quality throughout the SWP. The SWP water quality monitoring program exists due to increasingly stringent regulations, statewide drought conditions, threatened or endangered fish species, operational constraints, and increasing demands on SWP water supply, which

invariably affect the quality of the SWP aqueducts, forebays, lakes, and reservoirs. The program includes the analysis of over 200 different chemical, biological, and physical constituents at more than 40 stations.

SWP automated water quality monitoring stations continuously measure parameters such as turbidity, dissolved organic carbon, salinity, temperature, and fluorometry. Data generated from the autostations (Table 4-1) are used to assess spatial changes, short- and long-term trends, impacts from emergencies (e.g., spills and pipe ruptures), and the influence of operations and hydrology. Data from the automated stations is collected from dataloggers via the O&M water quality server. The data are automatically subjected to quality assurance and quality control (QA/QC) measures and posted hourly to the California Data Exchange Center (CDEC) website at: <http://cdec.water.ca.gov/>.

**Table 4-2 O&M SWP Water Quality Grab Sample Locations**

WDL Station Code	Station Name	WDL Station Code	Station Name
AN001000	Antelope Lake	KB000386	Dyer Reservoir (DYR), Check Siphon 1
KA000331	Banks Pumping Plant	FR001000	Frenchman Lake
KG000000	Barker Slough Pumping Plant	LD001000	Lake Davis
CAS00000	Castaic Dam Control Building	PE001000	Lake Perris, Inlet
CA001000	Castaic Lake	PE002000	Lake Perris, Outlet
CA002000	Castaic Lake Outlet Tower	PE003000	Lake Perris, Alisandro Island
CA003000	Castaic Lake	PE004000	Lake Perris, Moreno Palm Beach
KA007089	Check 13	PE005000	Lake Perris, Dam
KA017226	Check 21	PE006000	Lake Perris, Back-side of the Island
KA024454	Check 23	OR001000	Lake Oroville
KA024454	Check 29	SL000000	Pacheco Pumping Plant
KA029021	Check 39	PY001000	Pyramid Lake
KA030341	Check 41	PY002000	Pyramid Lake
KA040341	Check 66	PY003000	Pyramid Lake
KA000000	Clifton Court Forebay	SL001000	San Luis Reservoir, Trash Racks
KC000934	Coastal Branch	SL005000	San Luis Reservoir, Tunnel Island
KG002111	Cordelia Pumping Plant	KB004207	Santa Clara Terminal Tank
KB001638	Del Valle Check 7	KB000000	South Bay Pumping Plant (SBU)
DV000000	Del Valle Conservation Outlet (DCO)	SI001000	Silverwood Lake, Inlet
DV001000	Del Valle Reservoir	SI002000	Silverwood Lake, Outlet
DMC06716	Delta Mendota Canal, North of McCabe Road	TA001000	Thermalito Afterbay
KA041134	Devil's Canyon Headworks	TF001000	Thermalito Forebay
KA041288	Devil's Canyon Afterbay	KB002240	Vallecitos

The routine water quality grab samples collected from numerous SWP locations (Table 4-2) help identify pollutants and provide data to evaluate trends as well as quantify upstream and downstream impacts from several known and unknown sources that can contribute to water quality degradation. The grab samples are shipped to DWR's Bryte Chemical Laboratory for analysis and processing. Constituents analyzed can include dissolved solids, nutrients, minerals such as chloride, sulfate, and sodium, trace metals, herbicides, pesticides, organic substances, and phytoplankton (Table 4-3). The grab sample data are available publicly at: <http://www.water.ca.gov/waterdatalibrary/>.

Table 4-4 displays laboratory results for select stations from SWP water quality monitoring. Grab sample data from 2007 has been averaged for Thermalito Afterbay, the North Bay Aqueduct, the Central Valley Project's Delta-Mendota Canal, and the California Aqueduct.

Of the 156 pesticides, herbicides, and other organic compounds analyzed, six compounds had concentrations above the laboratory reporting limit. Compounds with confirmed detections were diuron, simazine, atrazine, metolachor, 2,4-dichlorophenoxyacetic acid (2,4-D) and dimethyl tetrachloroterephthalate (DCPA or dacthal) (Table 4-5).

**Table 4-3 O&M SWP Grab Sampling Schedule**

Station Name	Station Number	Depth (meters)	Major Minerals	Project Standard <sup>a</sup>	Nutrients	Total Organic Carbon	Dissolved Organic Carbon	UV-254	Suspended Solids	Turbidity	Bromide	Taste & Odor (MIB-geosmin)	Phytoplankton	Pesticides & Herbicides <sup>b</sup>	MTBE (Purgeable organics)	Radical	Total Dissolved Solids (TDS)	Copper (Dissolved)	Priority Pollutants	Total & Fecal Coliform	Pathogens EPA 1623	Iron and Manganese	Reservoir Profile	Asbestos	Automated Station <sup>c</sup>	Tytronics UVA Monitor	Title 22 <sup>d</sup>	Constituents of Concern <sup>e</sup>	
Feather River Watershed																													
Antelope Lake	AN001000			A	A								A										A						
Frenchman Lake	FR001000			A	A								A										A						
Lake Davis	LD001000			A	A																	M <sup>3</sup>							
Lake Oroville	OR001000		Q	Q	M <sup>2</sup>	Q	Q		Q	Q			M	Q	Q														
Thermalito Forebay	TF001000			Q					Q		Q		A																
Thermalito Afterbay	TA001000			M	M <sup>2</sup>				Q																				
South Bay Aqueduct																													
South Bay Pumping Plant																													
Dyer Reservoir																									#				
Del Valle Check No. 7	KB001632			M	M	M	M		M	M	M	M	M	M	M										#				
Del Valle Reservoir	DV001000	0.5		Q	M	Q	Q		Q	Q	Q	M	M	M	M						M	M	M						
	DV001000	4										M	M	M	M														
	DV001000	8										M	M	M	M														
Del Valle Conservation Outlet	DV000000			M <sup>1</sup>	M <sup>1</sup>	M <sup>1</sup>	M <sup>1</sup>		M <sup>1</sup>	M <sup>1</sup>	M <sup>1</sup>	W <sup>1</sup>								M <sup>1</sup>									
Valecitos	KB002250			M <sup>1</sup>	M <sup>1</sup>	M <sup>1</sup>	M <sup>1</sup>		M <sup>1</sup>		Q <sup>2</sup>	Q <sup>2</sup>	Q <sup>2</sup>												#				
Santa Clara Terminal Tank	KB004207			Q <sup>2</sup>																					#				
North Bay Aqueduct																													
Barker Slough Pumping Plant	KG000000			M	M	M	M		M	M	M	M	M	T	M										#				
Cordelia Reservoir	KG002111			Q					Q	Q	Q	Q													#				
San Luis Joint Use Facilities																													
Pacheco Pumping Plant	SL000000			M	M	M	M				W	W	M												#				

**Table 4-3 O&M SWP Grab Sampling Schedule**

Station Name	Station Number	Depth (meters)	Major Minerals	Project Standard <sup>a</sup>	Nutrients	Total Organic Carbon	Dissolved Organic Carbon	UV-254	Suspended Solids	Turbidity	Bromide	Taste & Odor (MIB-geosmin)	Phytoplankton	Pesticides & Herbicides <sup>b</sup>	MTBE (Purgeable organics)	Radiological	Total Dissolved Solids (TDS)	Copper (Dissolved)	Priority Pollutants	Total & Fecal Coliform	Pathogens EPA 1623	Iron and Manganese	Reservoir Profile	Asbestos	Automated Station <sup>c</sup>	Tytronics UVA Monitor	Title 22 <sup>d</sup>	Constituents of Concern <sup>e</sup>	
California Aqueduct																													
Clifton Court Forebay	KA000000		M	M	M	M	M	M	M	M	M	M	M	T	M	Q								Q	#	#			
Banks Pumping Plant	KA000331		M	M	M	M	M	M	M	M	M	M	M	T	M									Q	#	#			
Check 12	KA006633		M	M	M	M	M	M	M	M	M	M	M	T		Q								Q	#	#			
O'Neill FB Outlet (Check 13)	KA007089		M	M	M	M	M	M	M	M	M	M	M	T										Q	#	#			
Check 21	KA017226		M	M	M	M	M	M	M	M	M	M	M	T										Q	#	#			
Coastal Branch	KC000934		M	M	M	M	M	M	M	M	M	M	M	T											#		B		
Check 23	KA019705		M	M	M	M	M	M	M	M	M	M	M	T											#		B		
Check 29	KA024454		M	M	M	M	M	M	M	M	M	M	M	T											#				
Check 39	KA029021		M	M	M	M	M	M	M	M	M	M	M	T		Q								Q	#	#			
Check 41	KA030341		M	M	M	M	M	M	M	M	M	M	M	T											#				
Check 66	KA040341		M	M	M	M	M	M	M	M	M	M	M	T			M	M							#				
Devil Canyon Headworks	KA041134		M	M	M	M	M	M	M	M	M	M	M	T											#				
Devil Canyon Afterbay	KA041288		M	M	M	M	M	M	M	M	M	M	M	T											#				
Central and Southern SWP Reservoirs																													
San Luis Reservoir - Trashracks	SL001000	3	M	M	M	M	M	M	M	M	M	M	M																
San Luis Reservoir - Tunnel Island	SL005000		Q	M						Q	M	W	W <sup>3</sup>																
Pyramid Lake	PY001000												W <sup>3</sup>																
	PY003000												W <sup>3</sup>																
	PY005000												W <sup>3</sup>																
Castaic Lake	CA001000		Q	M	M	M	M	M	M	Q	M		W <sup>3</sup>																
	CA002000		Q	M	M	M	M	M	M	Q	M		W <sup>3</sup>																
Silverwood Lake	SI001000		Q	M						Q	M		W <sup>3</sup>																
	SI002000		Q	M						Q	M		W <sup>3</sup>																

**Table 4-3 O&M SWP Grab Sampling Schedule**

Station Name	Station Number	Depth (meters)	Major Minerals	Project Standard <sup>a</sup>	Nutrients	Total Organic Carbon	Dissolved Organic Carbon	UV-254	Suspended Solids	Turbidity	Bromide	Taste & Odor (MIB-geosmin)	Phytoplankton	Pesticides & Herbicides <sup>b</sup>	MTBE (Purgeable organics)	Radiochemical	Total Dissolved Solids (TDS)	Copper (Dissolved)	Priority Pollutants	Total & Fecal Coliform	Pathogens EPA 1623	Iron and Manganese	Reservoir Profile	Asbestos	Automated Station <sup>c</sup>	Titronics UVA Monitor	Title 22 <sup>d</sup>	Constituents of Concern <sup>e</sup>			
Lake Perris	PE001000 PE002000 PE005000			Q	M M M	M M M			Q	M		W <sup>3</sup> W <sup>3</sup> W <sup>3</sup>						M				W <sup>3</sup> W <sup>3</sup> W <sup>3</sup>									
Castaic Dam Control Bldg Warne Powerplant	CAS00000 WEWPP																M		Q						# #						
<b>Central Valley Project</b>																															
Delta Mendota Canal	DMC06716		M	M	M M M	M M M									T																
Sampling Frequency:																															
A=Annual																															
Q=Quarterly (Feb, May, Aug, Nov)																															
Q1=Feb, May, Aug-Dec																															
Q2=Monthly during Del Valle Releases or else Q																															
M=Monthly																															
M1=Monthly during Del Valle Releases																															
M2=Monthly (Apr-Nov)																															
M3=Monthly (May-Sep)																															
M4=Weekly in Winter or else Monthly																															
B=Bi-weekly during Pump-ins																															
#*=Future planned stations																															
T=Mar, Jun, Sep																															
#=Location of Automated WQ Station																															
#*=Future planned stations																															

<sup>a</sup> Project Standard: Alkalinity, Aluminum, Antimony, Arsenic, Barium, Beryllium, Boron, Cadmium, Calcium, Chloride, Chromium, Copper, Fluoride, Iron, Lead, Magnesium, Manganese, Mercury, Nitrate, Selenium, Silver, Sodium, Solids (Dissolved), Specific Conductance, Sulfate, Turbidity, and Zinc

<sup>b</sup> Herbicides and Pesticides: Chlorinated organics, Organo-phosphorus pesticides, Herbicides, Carbamates, and Miscellaneous pesticides

<sup>c</sup> Automated Station: [http://www.water.ca.gov/swp/waterquality/AutostationData/Autostation\\_map.cfm](http://www.water.ca.gov/swp/waterquality/AutostationData/Autostation_map.cfm)

<sup>d</sup> Title 22: 22 CCR Section 64431 or as modified for a particular project

<sup>e</sup> Constituents of Concern: Arsenic, Bromide, Chromium, Manganese, nitrate (as NO<sub>3</sub>), sulfate (SO<sub>4</sub>), total organic carbon (TOC), dissolved organic carbon (DOC), total dissolved solids (TDS)

**Table 4-4 Mean Water Quality at Selected SWP Grab Sample Locations, 2007**

Constituent	Units <sup>a</sup>	Detection Limit	Thermalito Afterbay at Outlet	North Bay Aqueduct, Barker Slough Pumping Plant	Delta-Mendota Canal Upstream of McCabe Road	California Aqueduct						
						Banks Delta Pumping Plant	O'Neill Forebay Outlet (Check 13)	Kettleman City (Check 21)	Near Highway 119 (Check 29)	Tehachapi Afterbay (Check 41)	Devil Canyon Head Works	
Alkalinity	mg/L as CaCO <sub>3</sub>	1	40	97	69	80	73	72	73	74	74	74
Antimony	mg/L	0.001	<0.001	<0.001	<0.001	<0.001	<0.001	<0.001	<0.001	NR	NR	NR
Arsenic	mg/L	0.001	<0.001	0.002	0.002	0.002	0.002	0.002	0.003	0.003	0.003	0.003
Beryllium	mg/L	0.001	<0.001	<0.001	<0.001	<0.001	<0.001	<0.001	<0.001	<0.001	<0.001	<0.001
Boron	mg/L	0.1	<0.1	0.1	<0.1	0.2	<0.1	<0.1	0.1	0.1	0.1	<0.1
Bromide	mg/L	0.01	<0.01	0.04	0.22	0.21	0.24	0.24	0.22	0.23	0.23	0.22
Calcium	mg/L	1	8	17	18	23	19	19	21	22	22	22
Chloride	mg/L	1	<1	19	73	77	80	80	73	73	74	74
Chromium	mg/L	0.001	<0.001	<0.001	0.001	0.001	0.001	0.001	0.002	0.002	0.001	0.001
Copper	mg/L	0.001	<0.001	0.002	0.002	0.002	0.001	0.002	0.001	0.002	0.003	0.003
Fluoride	mg/L	0.1	<0.1	<0.1	<0.1	<0.1	<0.1	<0.1	<0.1	<0.1	<0.1	<0.1
Hardness	mg/L as CaCO <sub>3</sub>	1	34	95	95	115	98	94	98	98	98	98
Iron	mg/L	0.005	<0.005	0.008	0.019	0.008	0.008	0.007	<0.005	<0.005	0.006	0.006
Lead	mg/L	0.001	<0.001	<0.001	<0.001	<0.001	<0.001	<0.001	<0.001	<0.001	<0.001	<0.001
Magnesium	mg/L	1	3	13	12	14	12	13	11	10	11	11
Manganese	mg/L	0.005	<0.005	0.015	0.005	<0.005	<0.005	<0.005	<0.005	<0.005	0.026	0.026
Nitrite + Nitrate	mg/L as N	0.01	<0.01	0.38	0.59	NR	0.58	0.58	0.79	0.82	0.73	0.73
Organic Carbon, Dissolved	mg/L as C	0.5	NR	3.3	3.2	3.0	2.8	2.8	2.5	2.5	2.8	2.8
Organic Carbon, Total	mg/L as C	0.5	NR	7.1	3.3	3.1	2.9	2.9	2.7	2.5	2.9	2.9
Phosphate-Ortho	mg/L as P	0.01	<0.01	0.09	0.06	NR	0.06	0.06	NR	0.05	0.05	0.05
Phosphorus-Total	mg/L	0.01	<0.01	0.22	0.10	NR	0.08	0.09	0.07	0.06	0.09	0.09
Selenium	mg/L	0.001	<0.001	<0.001	<0.001	0.001	<0.001	0.001	0.001	0.001	0.001	0.001
Sodium	mg/L	1	3	24	50	58	54	54	54	54	54	54
Specific Conductance	µS/cm	1	87	304	454	528	475	486	472	462	492	492
Sulfate	mg/L	1	2	24	32	51	33	34	38	37	37	37
Total Dissolved Solids	mg/L	1	51	173	260	296	268	269	263	265	274	274
Turbidity	N.T.U.	1	3	131	11	12	6	7	7	5	4	4
Zinc	mg/L	0.005	<0.005	<0.005	<0.005	<0.005	<0.005	<0.005	<0.005	<0.005	<0.005	<0.005

<sup>a</sup> mg/L = milligrams per liter; µS/cm = microsiemens per centimeter; N.T.U. = nephelometric turbidity unit; NR = No data recorded at this location.

NOTE: A grab sample is a single sample chosen to represent the conditions in a given matrix (usually natural water) at a specific location, depth, and time. All reported constituents are the yearly mean of laboratory analytical values sampled monthly from January to December. The yearly mean may be based upon one to twelve samples for the list of constituents.



**Table 4-5 Pesticides, Herbicides, and Other Organic Substances Detected in the SWP, 2007**

Sampling Location <sup>a</sup>	Sampling Station ID No.	Sample Date	Chemical Detected <sup>b</sup>	Concentration (µg/L) <sup>c</sup>
North Bay Aqueduct Barker Slough Pumping Plant	KG000000	3/21/07	Diuron	0.81
			Simazine	0.16
Delta Mendota Canal Upstream of McCabe Road	DMC06716	6/20/07	Diuron	0.72
		3/21/07	Diuron	2.35
			Simazine	0.13
		6/20/07	Atrazine	0.02
			Diuron	0.31
			Metolachlor	0.1
Banks Delta Pumping Plant	KA000331		Simazine	0.03
		9/19/07	2,4-D	0.6
		3/21/07	Diuron	0.81
			Simazine	0.12
		6/20/07	Diuron	0.66
O'Neill Forebay Outlet (Check 13)	KA007089		Metolachlor	0.2
			Simazine	0.05
		9/19/07	2,4-D	0.3
		3/21/07	Diuron	0.69
		6/20/07	Simazine	0.10
California Aqueduct Near Kettleman City (Check 21)	KA017226	9/19/07	2,4-D	0.4
		3/20/07	Diuron	1.25
			Simazine	0.12
		6/19/07	Simazine	0.06
California Aqueduct Near Highway 119 (Check 29)	KA024454	9/18/07	2,4-D	0.3
		3/20/07	Diuron	1.20
			Simazine	0.12
		6/21/07	Simazine	0.03
		9/19/07	2,4-D	0.4
California Aqueduct At Tehachapi Afterbay (Check 41)	KA030341		Dacthal (DCPA)	0.12
		3/28/07	Diuron	0.99
			Simazine	0.10
		6/20/07	Simazine	0.05
California Aqueduct At Devil Canyon Headworks	KA041134	9/19/07	2,4-D	0.3
		3/26/07	Diuron	1.36
			Simazine	0.07
		6/20/07	Simazine	0.05

<sup>a</sup> Water at these locations was sampled during March, June, and September.

<sup>b</sup> Only chemicals found in detectable amounts at the sampling stations are included in this table. Refer to the document entitled "Analytical Methods for Organic Chemicals" for a complete listing of all organic chemicals included in the laboratory analysis. This document is available online at <http://www.water.ca.gov/swp/waterquality/GrabSample/index.cfm>.

<sup>c</sup> µg/L = micrograms per liter

## Groundwater Turn-ins

Use of local groundwater is authorized by SWP to allow recovery of previously stored project and nonproject water and provide short-term solutions to address urgent local water supply needs. The pump-in is allowed only if the quality of the groundwater meets certain minimum requirements. It must be demonstrated that the groundwater is of acceptable quality prior to pumping the groundwater into the SWP. Groundwater pump-in tends to be authorized more frequently in dry years. In 2007, California experienced variations in water supply both locally and statewide because of prolonged drought conditions. A total of 359,048 acre-feet (af) of groundwater was accepted into the California Aqueduct between mileposts 70.88 and 245 from March to December 2007 by Arvin-Edison Water Storage District, Kern County Water Agency, Semitropic Water Storage District, Wheeler Ridge Water Storage District, and Kern Water Bank Authority.

## Municipal Water Quality Investigations Program

The Sacramento-San Joaquin Delta provides drinking water for more than 25 million people in California. Because the Delta and its tributaries are located in a relatively unprotected watershed, water quality degradation is possible from many sources, including industrial and municipal wastewater discharges, storm water runoff from cities, agricultural discharges, recreational activities, abandoned mines, and illegal dumping. The Municipal Water Quality Investigations (MWQI) program was established to evaluate the suitability of Delta water as a drinking water source, to identify sources of water quality degradation, and to evaluate means of eliminating or preventing degradation.

Program participants include the municipal water contractors of the SWP and Contra

Costa Water District. Program advisors include representatives of participating agencies, the U.S. Environmental Protection Agency (EPA), DPH, and California Urban Water Agencies.

## Real Time Data and Forecasting Comprehensive Program

The MWQI program expanded from monitoring, problem identification, and assessment to working toward a Real Time Data and Forecasting Comprehensive Program (RTDF-CP). This process began in 2006 and continued moving forward in 2007. The program goal is to enhance coordination, collaboration, and resource sharing among the various DWR water quality monitoring and modeling groups and with outside agencies and entities generating drinking water quality data or requiring real-time data to increase efficiency within their organizations.

There are seven elements associated with this effort:

- organizational coordination and collaboration between DWR monitoring and forecasting groups;
- coordination and collaboration with outside agencies to enhance real-time monitoring activities;
- real-time data acquisition through monitoring;
- enhancement of forecasting and fingerprinting of drinking water quality through use of computer models;
- information management and dissemination;
- emergency response preparedness as related to drinking water quality; and
- scientific support studies.

Additional resources were required to implement this program, and a request for additional position authority was submitted for the 2007–2008 fiscal year. Additional

staff were hired at the end of 2007, and as a result the RTDF-CP has been expanded to include staff in the Bay Delta Office, the SWP Operations Support Office, and the SWP Operations Control Office.

One RTDF-CP component is to evaluate the need for and feasibility of installing in situ equipment in locations that would provide useful information for utilities, that together with modeling could provide an “early warning system” of changes in water quality approaching drinking water intakes. One location identified for the installation of new in situ instrumentation for organic carbon monitoring is the Jones Pumping Plant at the Delta Mendota Canal. In 2007, MWQI entered into negotiations with the San Luis Delta Mendota Water Authority to construct a new water quality monitoring station at this location.

In addition to taking the first steps to install a new station at Jones Pumping Plant, the MWQI program continued operating three automated carbon analyzers in the Delta at the Banks Pumping Plant, Sacramento River at Hood, and the McCune station on the San Joaquin River. These analyzers automatically sample ambient water, determine the total and dissolved organic carbon concentrations, and send the data to Sacramento, where it is posted on the California Data Exchange (CDEC) website. In addition to carbon analyzers, automated ion chromatography instruments at the Banks and McCune stations began reporting bromide, chloride, sulfate, and nitrate data to CDEC. In 2006, these data were only available to users through MWQI staff.

To support forecasting efforts, a preliminary version of the DSM2-Aqueduct Extension Model was completed in 2007. This model will be refined to increase forecasting resolution and allow drinking water utilities to better react to short- and long-term changes in source water quality. Once complete, the model will also be capable

of running in a planning mode. This will allow water managers to evaluate changes in drinking water quality associated with changes in water supply operations and watershed pollution control strategies.

## Reports

State of California drinking water regulations require certain public water purveyors to complete watershed sanitary surveys every five years. Watershed sanitary surveys must include a physical and hydrogeological description of the source watershed, a summary of source water quality monitoring data, a description of activities and sources of contamination, a description of any significant changes that have occurred since the last survey which could affect the quality of the source water, a description of watershed control and management practices, an evaluation of the system’s ability to meet applicable drinking water standards, and recommendations for corrective actions. The 2006 *State Water Project Watershed Sanitary Survey Report*, the fourth in a series for the SWP, provides information in the latest 5-year update from the original sanitary survey required by DPH in 1990. This update report was completed in June 2007 and can be downloaded from the MWQI website: <http://www.water.ca.gov/waterquality/drinkingwater/index.cfm>.

## Special Studies

### *Organic Carbon Method Evaluation Study*

Because accurate organic carbon data are so critical to drinking water operations, MWQI staff completed a series of experiments in 2007 that examined whether field instruments satisfactorily removed inorganic carbon—one area that the EPA has focused on as a source of error in organic carbon measurements. Based on the study results, sample preparation methods were modified at all real-time organic carbon instruments to ensure adequate removal of inorganic carbon.

### **Comparison of Organic Carbon Analyzers**

In 2000, MWQI evaluated the water quality management implications of using different organic carbon analyzers in the Delta. The study tested whether analyzers using different methods were equally capable of measuring organic carbon in diverse environmental water samples from the Delta and its watersheds. The study also evaluated whether the different instruments might provide differing organic carbon concentration measurements which, in turn, could trigger different regulatory requirements. MWQI staff concluded that properly operating instruments using any of the standard methods were equally capable of analyzing organic carbon concentrations typically found in Delta waters. The study results were published in the May 2007 issue of the journal *San Francisco Estuary and Watershed Science*.

### **Natural Organic Matter Source Assessment**

Understanding the sources of organic compounds to the Delta is just as important to drinking water stakeholders as knowing their concentrations. MWQI has partnered with the University of New Orleans and Lawrence Livermore National Laboratory in a CALFED-funded project to use carbon, nitrogen, and sulfur isotopes to determine the seasonal contribution of natural organic matter derived from peat islands to the carbon load in the SWP. Peat soils found on many Delta islands contain natural organic matter that is several thousand years old. The hypothesis is that this “old” carbon should be distinguishable from relatively “modern” carbon. Using age as a fingerprint, MWQI hopes to provide information on the relative sources of organic carbon at an export site like Banks Pumping Plant. Samples have been collected and analysis of the samples has begun. Knowing the relative contribution of different sources of organic carbon could help focus management practices so that organic carbon discharges are minimized.

### **Staten Island Wetlands Loading Investigation**

To examine organic carbon loads from an agricultural context, DWR, the Bureau of Land Management, Ducks Unlimited, DFG, and the Nature Conservancy partnered on a CALFED grant to develop a wildlife friendly farm management project on the Delta’s Staten Island. The MWQI program was responsible for the project’s water quality component, which represented one of the first times that loading from a Delta peat island had ever been quantified. In June 2007, a final report on the water quality results was provided to CALFED. This study determined that organic carbon loads discharged from Staten Island were greater than discharges from a non-peat soil agricultural area (Colusa Basin Drain) on the Sacramento River, but that nutrient loads discharged from the island were much lower than this drain. Both organic carbon and organic nitrogen seasonal patterns were similar. The highest concentrations were observed during the winter, even though the greatest volume of water pumped off the island occurred in the summer. The total organic carbon loading was approximately 9.05 megagrams per square kilometer per year, while total nitrogen loading rates were approximately 1.57 grams per square meter per year.

### **Bryte Chemical Laboratory**

Established in 1951, Bryte Chemical Laboratory is DWR’s primary analytical laboratory. Its main function is to analyze drinking, surface, ground, and waste water for the various water quality programs within DWR. Since 1990, the laboratory has been certified biannually by the DPH Environmental Laboratory Accreditation Program (ELAP) to perform water quality analyses following EPA or American Water Works Association (AWWA) analytical methods. This certification allows the laboratory to perform regulatory work that can be used for compliance purposes. The laboratory continues to perform the vast

majority of chemical and other related analyses required to support DWR's water quality programs. Every year, thousands of water samples are routinely analyzed for standard minerals, nutrients, metals, pesticides, herbicides, volatile organic compounds, and many other chemical constituents.

In 2007, the laboratory upgraded its capability and capacity to detect and analyze anions (chloride, sulfate, bromide, fluoride, nitrate) and ortho phosphate in water samples with the purchase of two fully automated and computer controlled integrated reagent-free ion chromatography instrument systems. The ion chromatographs are equipped with new technologically advanced automated eluent generation systems that minimize the time, labor, costs, and errors of manually prepared reagents.

The laboratory has continued to manage a variety of analytical contracts with other State agencies and several outside laboratories in accordance with the master contract policy approved in fiscal year 1994–1995. These contracts are used to perform analyses that are beyond the capability and capacity of the laboratory, such as solids and fish tissues. The laboratory works in conjunction with the DWR Municipal Water Quality Program QA/QC Section to replace these contracts as they expire each fiscal year. In 2007, the DFG contract for fish tissue analysis and the Metropolitan Water District of Southern California contract for taste and odor analysis were renewed.

SWP security and protection has continued to be a primary goal for DWR since the terrorist attack on September 11, 2001. To help protect the SWP from biochemical and chemical agents, the laboratory continued in 2007 to be an active member in a group of laboratories called the California Association of Mutual Aid Laboratories Network (CAMAL Net) headed by DPH. The laboratory

network's main objective is to voluntarily assist DPH in the analysis of chemical agents in water quality samples should a natural disaster or terrorist event occur in California. The assistance is only required should the analytical capacity of DPH be exceeded or to confirm the presence or absence of chemical agents in water quality samples provided by DPH. In 2007, Bryte Laboratory was classified as a Level II participating laboratory in the CAMAL Net organization. Level II only allows the laboratory to receive samples that are prescreened and determined to not be hazardous to laboratory personnel.

## Suisun Marsh Activities

Suisun Marsh consists of approximately 59,000 acres of tidal and managed brackish water wetlands and 30,000 acres of bays and sloughs. It is the largest contiguous brackish marsh remaining in the United States. Situated in southern Solano County, west of the Sacramento-San Joaquin Delta and north of Suisun Bay, the marsh encompasses more than 10 percent of California's remaining natural wetlands. In addition, the marsh is the resting and feeding ground for thousands of waterfowl migrating on the Pacific Flyway.

Since the early 1970s, the California Legislature, SWRCB, Reclamation, DFG, Suisun Resource Conservation District (SRCD), DWR, and other agencies have focused on preserving the Suisun Marsh as a unique environmental resource. Figure 4-2 shows the water quality monitoring and compliance sampling locations.

## Blacklock Restoration Project

DWR received CALFED Ecosystem Restoration Program grant funds in 2001 to acquire 70 acres of what is referred to as the Blacklock property in December 2003. DWR, in cooperation with Reclamation, DFG, USFWS, and SRCD, implemented the Blacklock Restoration Project (location shown on Figure 4-2). This project restored diked, managed wetlands to tidal wetlands.



**Figure 4-2 Compliance and Monitoring Stations and Water Management Facilities in the Suisun Bay and Marsh**

## **Habitat Management, Preservation, and Restoration Plan for the Suisun Marsh (Suisun Marsh Plan)**

On March 2, 1987, the Department of Water Resources (DWR), the Bureau of Reclamation (Reclamation), the Department of Fish and Game (DFG), and Suisun Resource Conservation District (SRCD) signed the Suisun Marsh Preservation Agreement (SMPA). The objective of SMPA is to assure that Reclamation and DWR mitigate for any adverse effects of the Central Valley Project (CVP) and State Water Project (SWP) on wetlands in the marsh, as well as a portion of the adverse effects of other upstream diversions. This objective is primarily accomplished by operation of large-scale facilities in the marsh to maintain a dependable supply of adequate quality water within Suisun Marsh channels. These large-scale facilities are currently operated and maintained by DWR. They include the Suisun Marsh Salinity Control Gates, Roaring River Distribution System, Morrow Island Distribution System, and Goodyear Slough Outfall (see Figure 4-2).

On August 4, 1995, the Suisun Marsh Coordinators, representing the four agencies party to SMPA, began discussions directed at updating the agreement. Representatives from Reclamation, DWR, DFG, and SRCD established a negotiating team, technical group, drafting committee, and environmental documentation team. Beginning September 1995, the SMPA negotiating team met monthly and made significant progress in developing the basis to amend the agreement. Representatives from the SWP and CVP water contractors actively participated in the negotiations. The Revised SMPA, dated June 20, 2005, reflects future hydrologic and salinity conditions in the Suisun Marsh as prescribed by the State Water Resources Control Board (SWRCB) 1995 Water Quality Control Plan and places more emphasis on improving water and land management practices and facilities operations, in partnership with the local managed wetlands landowners.

In 2001, the Suisun Principal Agencies, a group of agencies with primary responsibility for Suisun Marsh management, directed the formation of a charter group to develop a plan for the marsh that would balance the needs of CALFED, the SMPA, and other plans by protecting and enhancing existing land uses, existing waterfowl and wildlife values. The Principal Agencies are U.S. Fish and Wildlife Service (USFWS), Reclamation, DFG, DWR, National Marine Fisheries Service (NOAA Fisheries), SRCD, and CALFED Bay-Delta Program (CALFED).

The Principal Agencies directed the formation of a charter group to develop the Suisun Marsh Habitat Management, Preservation, and Restoration Plan, known as the Suisun Marsh Plan (SMP). In addition to the Principal Agencies, the charter group includes other regulatory agencies such as the U.S. Army Corps of Engineers (Corps), San Francisco Bay Conservation and Development Commission (BCDC), and the State and Regional Water Quality Control Boards.

(continued)

Development of the SMP has been a multiagency, collaborative process to design a plan that will balance the goals and objectives of CALFED, SMPA, and other management and restoration programs within the Suisun Marsh in a manner that is responsive to the concerns of all stakeholders and is based upon voluntary participation by private landowners. Landowners in the Marsh and other agencies that have a jurisdictional or other stake in the outcome of the SMP have been engaged in the process.

Overall, the SMP is intended to balance the benefits of tidal wetland restoration with other habitat uses in the marsh by evaluating alternatives that provide for a politically acceptable change in marsh-wide land uses, such as salt marsh harvest mouse habitat, managed wetlands, public use, and upland habitat. SMP will be a comprehensive plan designed to address the various conflicts regarding use of marsh resources, with the focus on achieving an acceptable multi-stakeholder approach to the restoration of tidal wetlands and the management of managed wetlands and their functions. As such, the SMP is intended to be a flexible, science-based, management plan for Suisun Marsh, consistent with the Revised SMPA and CALFED. It also is intended to set the regulatory foundation for future actions.

In July 2006, a natural breach in the levee occurred. It was determined that the planned breach should still be constructed to allow for full tidal flow and optimum sediment transportation. The planned breach construction occurred on October 3 and 4, 2006.

The project goals and objectives are to: (1) restore the area to a fully functioning, self-sustaining marsh ecosystem created through restoration of natural hydrologic, sedimentation, and biological processes; (2) increase the area and contiguity of emergent wetlands providing habitat for tidal marsh species; and (3) assist in the recovery of at-risk species. The final restoration plan for the project was published in June 2007.

A 10-year monitoring program at the site is being done in cooperation with State and federal agencies. There are 15 parameters being monitored, including sediment accretion, channel network evolution, vegetation development, water quality, methyl mercury, and avian use.

For more information about the Blacklock Project, visit the Suisun Marsh Program webpage at <http://www.water.ca.gov/suisun/restoration>.

### Revised Suisun Marsh Preservation Agreement

In 1987, DWR, Reclamation, DFG, and SRCD signed the Suisun Marsh Preservation Agreement (SMPA). SMPA contains provisions for actions to control channel water and soil salinity to mitigate impacts of the SWP, CVP, and other upstream diverters on managed wetlands in Suisun Marsh. A Revised SMPA and Revised Mitigation and Monitoring Agreements were signed in 2005 to make channel water salinity requirements consistent with the SWRCB's D-1641 and replace additional large scale water management facilities with landowner water and management activities to meet the SMPA objectives in the western Marsh.

The Revised SMPA includes the following actions: operate the Initial Facilities and



Suisun Marsh Salinity Control Gates; meet channel water salinity standards consistent with D-1641; implement a water manager program; provide portable pumps; update Individual Ownership Adaptive Management Habitat Plans; establish a drought response fund; and realign and stabilize turnouts on the Roaring River Distribution System.

During 2007, SRCD continued to implement these activities.

The Suisun Habitat Management, Preservation, and Restoration Plan, known as the Suisun Marsh Plan (SMP) provides funding for private landowner wetland management activities that are included in both the SMP and Revised SMPA. (See the following section on SMP and the SMP sidebar.)

### **Suisun Habitat Management, Preservation, and Restoration Plan**

During 2007, work continued on the Suisun Habitat Management, Preservation, and Restoration Plan (Suisun Marsh Plan [SMP]). High level representatives from the Suisun Marsh Charter Group agencies, met on a monthly basis to review potential actions and develop alternatives to be included in the SMP. The “writing group,” a team of staff level representatives of some of the Principal Agencies, also met monthly to develop impacts analyses for the EIS/EIR. The SMP EIR/EIS is being developed in coordination with the recommendations of the Delta Vision Process and with information and evaluation provided by the Delta Risk Management Study and other regional programmatic processes. Reclamation and USFWS have agreed to serve as joint National Environmental Policy Act lead agencies, and DFG has agreed to serve as the California Environmental Quality Act lead agency.

## **Operation and Maintenance**

### ***Initial Facilities Maintenance***

Several facilities constructed by DWR operate in the Suisun Marsh. They are identified in the *Plan of Protection for the Suisun Marsh* (1984) and the 1987 SMPA. These facilities provide lower salinity water to managed wetlands. The initial facilities, including the Roaring River Distribution System, Morrow Island Distribution System (MIDS), and Goodyear Slough Outfall, were constructed in 1979 and 1980. The Suisun Marsh Salinity Control Gates were installed and became operational in 1988. (See Figure 4-2.)

### ***Morrow Island Distribution System Fish Screen and Alternatives***

MIDS is an interior ditch bordered by levees that was created to distribute water to managed wetlands. Relatively less saline water is taken from Goodyear Slough in the west through water control structures which transport the water into a ditch. Water is then distributed to managed wetlands through private landowner water control structures along the ditch. Water not used by the landowners exits into Grizzly Bay through water control structures in the east. MIDS is owned by the Department of the Interior, Reclamation, and DWR. DWR operates and maintains this facility.

In 1997, USFWS issued a BO for MIDS maintenance work. The BO required that Reclamation and DWR install a fish screen at the MIDS intake on Goodyear Slough.

The cost of adding a fish screen to the MIDS intake structure was likely to be high, and the effectiveness of such screening to conserve Suisun Marsh fish populations was unknown. Therefore, DWR and Reclamation studied fish entrainment from September 2004 through June 2006 to evaluate whether screening the diversion would provide substantial benefits to local populations of listed fish species. The study

objectives were to determine what species of fish and what life stages are entrained and to assess whether certain species of fish are more likely to be entrained than others.

Based on the study results, a fish screen at MIDS would likely have negligible benefits to sensitive fish populations. (See Bulletin 132-07, Chapter 4, for a summary of sampling results.) USFWS reinitiated consultation on the MIDS maintenance project. DWR and Reclamation are proposing to fulfill the outstanding terms and conditions of the USFWS-issued BO by acquiring and protecting in perpetuity aquatic habitat in Suisun Marsh. The status of this proposal remains on-going without new notable developments or changes.

### **Suisun Marsh Salinity Control Gates**

The Suisun Marsh Salinity Control Gates are operated from October 1 through May 31, as needed, to meet salinity standards. When they are not in operation, they are placed in an open position to minimize fish concerns related to predation and impedance. In the past, the gates operation and installation or removal of the flashboards has varied due to salinity conditions, fisheries agencies' requests for sensitive species concerns, or special studies and repairs.

**Gates Status for 2006–2007.** During the 2006–2007 control season (October 2006 through May 2007), the gates did not operate until late January 2007 since salinity levels in fall 2006 were not of concern in the marsh. Operations of the gates commenced January 25, 2007 (flashboards installed on January 24, 2007) as salinity levels became a concern. Operations to control salinity continued until March 1, 2007. Thereafter, salinity levels were favorable due to high outflow in March 2007 and remained under control. The gates were not needed for the remainder of the control season (flashboards removed on April 23, 2007).

Past years' salmon passage studies indicate that boat lock gates being open during gate operations provides optimal fish passage. Starting with the 2005–2006 control season and thereafter, the boat lock gates will remain open during gate operations in support of fish passage and will only be closed for a short period to allow boat passage, as agreed by Reclamation, DWR, DFG, and SRCD and set forth in the Revised SMPA (2005).

## **Monitoring**

### **Water Quality and Compliance**

Salinity levels during the 2006–2007 control season were well below the monthly standards. Details of the salinity levels in the marsh are available in the monthly report entitled, *Suisun Marsh Monitoring Program Channel Water Salinity Report*, at: <http://www.water.ca.gov/suisun/dataReports>.

### **Suisun Marsh Expenditure History**

Suisun Marsh expenditures and reimbursements administered by DWR for calendar years 1968 through 2007 are summarized in Table 4-6. From 1968 through December 31, 2007, DWR disbursed more than \$123.7 million of SWP funds for planning, design, environmental documentation, construction, maintenance, monitoring, mitigation, and permit compliance in support of implementing the Plan of Protection for Suisun Marsh through the SMPA and for meeting standards set by SWRCB. Reclamation has reimbursed DWR about \$46.6 million (38 percent), and the State's General Fund has reimbursed about \$9.4 million (8 percent). These figures do not include up-front payments made by Reclamation for staff and other direct costs, as well as about \$5.7 million in Reclamation interest payments during 1988 and 1989.

Annual figures are reported in Table 4-6 for DWR's up-front payments, Reclamation reimbursements, General Fund reimbursements, and DWR's cumulative expenditure balance.

**Table 4-6 Suisun Marsh Expenditures and Reimbursements Administered by DWR (in dollars)**

Year [1]	Reach 305 Costs [2]	General Fund Payment [3]	Adjustment for General Fund Payment <sup>a</sup> [4]	Reclamation Invoice Payment [5]	Interest Payment Credited Back to Contractors [6]	Net SWP Costs [2] through [6] [7]	Recreation Costs <sup>c</sup> [8]	SWP Water Contractors' Costs [7] minus [8] [9]
1968	10,571					10,571	359	10,212
1969	34,181					34,181	1,162	33,019
1970	23,343					23,343	794	22,549
1971	1,042					1,042	35	1,007
1972	47					47	2	45
1973	0					0	0	0
1974	0					0	0	0
1975	2,709					2,709	92	2,617
1976	32,960					32,960	1,121	31,839
1977	37,475					37,475	1,274	36,201
1978	350,831					350,831	11,928	338,903
1979	3,660,099					3,660,099	124,441	3,535,658
1980	5,005,759					5,005,759	170,283	4,835,476
1981	2,964,974					2,964,974	101,311	2,863,663
1982	2,955,705			(2,500,000)		455,705	101,111	354,594
1983	2,754,094					2,754,094	93,643	2,660,451
1984	2,418,344					2,418,344	82,388	2,335,956
1985	2,332,773					2,332,773	79,432	2,253,341
1986	6,495,322					6,495,322	220,843	6,274,479
1987	13,600,701					13,600,701	462,424	13,138,277
1988	7,456,364			(17,368,725) <sup>b</sup>	(2,039,752)	(11,952,113)	253,516	(12,205,629)
1989	2,341,960	(9,478,000)	6,634,600	(1,219,691) <sup>b</sup>	(283,857)	(2,004,988)	79,643	(2,084,631)
1990	3,030,010			(695,450)		2,334,560	101,460	2,223,100
1991	6,223,042			(2,925,429)		3,297,613	210,454	3,087,159
1992	2,737,259			(1,174,655)		1,562,604	91,951	1,470,653
1993	2,979,255			(238,130)		2,741,125	99,897	2,641,228
1994	3,192,213			(1,962,549)		1,229,664	107,281	1,122,383
1995	2,721,978			(647,138)		2,074,840	91,218	1,983,622
1996	3,391,678			(1,482,396)		1,909,282	113,244	1,796,038
1997	3,634,267			(1,520,219)		2,114,048	121,132	1,992,916
1998	5,342,834			(1,107,501)		4,235,333	177,132	4,058,201
1999	8,867,742			(2,696,200)		6,171,542	301,424	5,870,118
2000	2,857,534			(3,300,053)		(442,519)	98,145	(540,665)
2001	2,623,227			(444,009)		2,179,218	89,494	2,089,724
2002	3,752,265			(791,319)		2,960,946	124,379	2,836,566
2003	3,258,583			(2,389,979)		868,604	107,556	761,038
2004	2,874,629			(952,940)		1,921,689	94,885	1,826,804
2005	3,940,876			(1,409,296)		2,531,580	130,049	2,401,531
2006	5,790,721			(868,449)		4,922,272	193,303	4,728,968
2007	4,085,998			(939,879)		3,146,119	134,845	3,011,274
<b>Total</b>	<b>123,783,585</b>	<b>(9,478,000)</b>	<b>6,634,600</b>	<b>(46,634,007)</b>	<b>(2,323,609)</b>	<b>71,982,569</b>	<b>4,174,336</b>	<b>67,808,232</b>

<sup>a</sup> Under State Assembly Bill 1442, the General Fund paid 20% of the Suisun Marsh costs through June 1988, which amounts to \$9,478,000. This payment includes \$2,843,400, which represents 6% of the costs through June 1988 paid by the General Fund. This amount has reduced the costs billed to the SWP water contractors. The remaining \$6,634,600 received from the General Fund represents DWR's recreation project purpose share of 14%.

<sup>b</sup> Excludes interest payments made by Reclamation.

<sup>c</sup> Allocation factors for capital recreation costs have changed from 14% to 3.4% and Operations & Maintenance recreation costs from 14% to 3.3%.



## **Chapter 5**

# **Local Assistance**

*Wetlands in the Delta.*

## Significant Events in 2007

**B**y the end of 2007, 78 water districts, three environmental interest groups, and more than 55 other interested groups had signed the Agricultural Water Management memorandum of understanding (MOU) as members of the Agricultural Water Management Council (Ag Council).

DWR received 29 urban water management plans.

From January through December of 2007, 4,117 documents were screened by the Environmental Document Review Section.

*Information in this chapter was contributed by the Division of Statewide Integrated Water Management, the Division of Environmental Services, and the Division of Integrated Regional Water Management.*

The Department of Water Resources (DWR) manages the Davis-Grunsky Act Program, water use efficiency, agricultural drainage, environmental impact document review, and Water Conservation Bond Law programs, and participates in several other programs that assist local agencies and benefit State Water Project (SWP) contractors.

## Davis-Grunsky Act Program

The Davis-Grunsky Act, authorized in 1960 as part of the Burns-Porter Act, provides construction loans for local domestic water projects and agricultural water conservation projects. It also provides grants for recreation and fish and wildlife enhancement. Loans and grants may be given to rehabilitate dams and reservoirs.

DWR's ongoing administration of the program provides oversight of the 32 recreation grant projects to ensure compliance with the contracts. Administration costs are recovered from the revenues provided by the repayment of Davis-Grunsky Act loans. The recreation grant contracts are being amended to reflect actual facilities constructed and the modification of DWR's fee oversight function.

## Water Use Efficiency

The Water Use and Efficiency Branch in the Division of Statewide Integrated Water Management (DSIWM) activities include providing technical assistance to local agencies; managing water use efficiency financial assistance programs; managing the California Irrigation Management Information System (CIMIS); reviewing, tracking, and reporting on urban and agricultural water management plans; and managing drainage and water recycling/desalination projects.

## California Irrigation Management Information System

CIMIS is a network of automated weather stations that collects weather data and transmits it to a central repository in Sacramento each day. After performing quality control and calculations, the data are made available to the public for such diverse purposes as irrigation scheduling, resource planning, research, and modeling.

In 2007, DWR's CIMIS network remained at 130 stations, with approximately 70 percent of the stations belonging to local cooperators. The demand for CIMIS data has increased steadily since its establishment in 1982. The number of registered data users has grown from 661 in 1989, to more than 7,000 in 2007.

Approximately 225,000 reports were generated from the database through its website (<http://wwwcimis.water.ca.gov>) for information in 2007. Users can register online, access archived data, download data files, and peruse content about the CIMIS program and other helpful metadata and information. A separate but concurrently operating database and web application is operating for redundancy to protect the data.

Other ongoing CIMIS enhancements include the nonideal site weather station network study and the incorporation of the Geostationary Operational Environmental Satellite (GOES) model producing statewide daily reference evapotranspiration (ET<sub>0</sub>) maps. In addition, the staff is updating CIMIS

brochures, evapotranspiration calculations, other methods of data acquisition and dissemination, data quality refinements, and technical assistance.

## Recycling and Water Desalination Branch

The goal of DSIWM's Recycling and Water Desalination Branch is to improve water use efficiency by promoting increased use of nonconventional water sources—namely recycled water and desalinated brackish and ocean waters—through planning, technical, and financial assistance. As part of a balanced water portfolio, nonconventional water sources will help meet existing and future water supply and environmental needs. The branch's mission consists of increasing the safe and beneficial use of recycled water, advancing energy-efficient treatment and desalination technologies, and encouraging economically and environmentally acceptable use of desalinated brackish and ocean waters.

In 2007, the Recycling and Water Desalination Branch activities included the following:

- provided timely water recycling and desalination information reports;
- continued to develop new knowledge on water recycling and desalination activities and projects in California;
- developed the Proposition 50 desalination grant agreements for 24 projects awarded in the 2006 funding cycle for a State share of \$21.5 million;
- continued to develop and manage grant agreements for the 24 different projects, which were awarded through the second 2004 cycle of the desalination grant program;
- continued to provide technical knowledge on water recycling and water desalination issues, including responses to questions from policy makers, regulators, State and local agencies, and the public on permitting issues; public health regulations; types, locations, and amounts of water reuse occurring, and desalinated water production and use;
- provided technical assistance on the recycled water section in the *Model Water Efficient Landscape Ordinance* —AB 1881;
- visited 11 of the Proposition 50 projects, as part of management responsibilities;
- participated in the Grant Management and Bond Accountability Project meetings
- participated in the Sacramento Water Recycling Advisory Committee (WRAC), and WRAC meetings;
- represented DWR in several meetings, workshops, and conferences and published technical papers on water recycling and made presentations about California's water recycling and desalination activities to DWR's visitors;
- assisted the California Building Standards Commission's staff to address comments from the public as well as the Green Building Code Advisory Committee, concerning proposed water use efficiency standards, and the use of recycled water and gray water in green buildings. The standards are to be included in the proposed California Green Building Standards Code as part of Title 24;
- assisted with the implementation of several Recycled Water Task Force recommendations;
- served on several project advisory committees to guide various desalination projects managed by WaterReuse Research Foundation and the Water Research Foundation (formerly the American Water Works Association Research Foundation or AwwaRF);
- published several articles on various water recycling and water desalination issues in the DWR's *Water Conservation News*;
- participated in the Reclamation's brine-concentrate management study. The study conducted a survey of the current state of Southern California's brine-

concentrate treatment and disposal facilities, regulatory requirements, and emerging/secondary constituent issues; evaluated and compared treatment and disposal methods that could meet forecasted trends in brine-concentrate management for coastal and inland areas; and provided a comparative review of recommended projects for coastal and inland areas to meet expected brine-concentrate treatment and disposal requirements; and

- continued work on the desalination planning guidebook in collaboration with the California State University Sacramento, Center for Collaborative Policy that includes guidelines for developing environmentally acceptable water desalination projects that meet regulatory and permitting requirements. The guidebook is an important resource for project proponents and communities. The planning process outlined in the guidebook is intended to identify and address the siting, regulatory, technical, environmental, and other issues to be considered in determining whether and how to proceed with a desalination project; and
- continued work on the WateReuse Curriculum Committee in collaboration with the WateReuse Foundation and other California public agencies who have the common goal of educating California youth in various aspects of water recycling. The Committee's goal is to produce water cycling education information and resources.

### Proposition 50 Water Use Efficiency Grant Program

Proposition 50 provided approximately \$105 million for the Water Use Efficiency Grant Program for three years. The Water Use Efficiency Grant Program provided funds for implementation of all urban Best Management Practices (BMPs) and agricultural Efficient Water Management

Practices (EWMPs) that would result in local, regional, and statewide benefits. Some State benefits are water conservation, flow and timing, water quality, and energy. The first Proposition 50 Water Use Efficiency grant cycle was in 2005 and resulted in 72 cooperative agreements with funding for urban and agricultural projects. The second Proposition 50 Water Use Efficiency grant cycle started in 2006 and resulted in initiation of development of 52 cooperative agreements. These cooperative agreements were finalized during 2007.

For both grant cycles, a competitive proposal solicitation package (PSP) was developed along with a comprehensive review and evaluation of the project proposals. The PSP defines project benefits, eligible projects, eligible applicants, funding caps, reporting, and other contract requirements. Both grant cycles were two-step processes. Applicants were required to submit a Concept Proposal in Step 1, and successful Concept Proposals were invited to submit a Full Proposal in Step 2. All submittals were made on-line through the Financial Assistance Application Submittal Tool (FAAST).

### Agricultural Water Management Plans

By the end of 2007, 78 water districts, 3 environmental interest groups, and more than 55 other interested groups had signed the Agricultural Water Management memorandum of understanding (MOU) as members of the Agricultural Water Management Council (Ag Council). The agricultural signatories represent more than 4.9 million acres of irrigated agricultural land statewide.

In 2007, the Ag Council endorsed an additional three agricultural water management plans that had been submitted by agricultural water suppliers. These plans have since become the basis for the districts'



water conservation efforts. The districts with endorsed water management plans are expected to prepare and submit a biennial progress report to the Ag Council from the date their plan was endorsed. DWR staff provides technical review and evaluation of these plans. DWR also reviewed four biennial progress reports for the Ag Council.

DWR staff provided technical assistance to water districts to prepare water management plans and to implement EWMPs, as well as administrative and programmatic assistance to both the council and water districts.

### **Three-Way Cooperative Agreement— Ag Council**

In 2001, DWR set up a three-way cooperative agreement among itself, Reclamation, and CALFED, and managed the State-funded portion of the agreement. This agreement provided funding to the Ag Council for three years to help implement the MOU. The management and implementation of tasks in the agreement were closely coordinated with Reclamation's Mid-Pacific Region. This activity, with a \$1.2 million budget, was shared equally between DWR and Reclamation. By the end of 2005, all DWR funds were spent for relevant tasks identified in the three-way cooperative agreement. The work continued with the federal share of funds and tasks. By the end of 2007, all provisions of this agreement were completed and the agreement is no longer in effect. No attempts have been made to reestablish this cooperative effort.

### **Urban Water Management Plans**

DWR received 29 urban water management plans in 2007. The 2005 Urban Water Management Plan (UWMP) Guidebook and DWR 2005 UWMP Review Sheets were posted on the Urban Water Management website and provided to urban water suppliers throughout the State. In addition, technical assistance was available on how to prepare a UWMP.

## **Agricultural Drainage Program**

The Agricultural Drainage Program's mission is to seek in-valley solutions to the surface and subsurface agricultural drainage water problems in the State, particularly the San Joaquin Valley, and to improve water quality in the San Joaquin River by promoting measures to reduce salinity and discharge of harmful elements.

Even though the San Joaquin Valley Drainage Implementation Program (SJVDIP) has been idle since 2003, DWR continues to implement many of its recommendations through its Agricultural Drainage Program. DWR works in partnership with California universities, CALFED, Reclamation, resource conservation districts, watershed groups, water and drainage districts, and many other local, State, and federal entities. These activities include the following:

- developing, educating, and promoting the use of Integrated On-Farm Regional Drainage Management systems in the San Joaquin Valley;
- providing technical assistance and collaborating with water and drainage districts and local entities to reduce and control surface and subsurface agricultural drainage water;
- maintaining research and demonstration projects to develop drainage reuse systems, including the development of cost-effective, salt-tolerant crops (including energy crops), drainage treatment, disposal technologies, and salt separation and utilization;
- monitoring the quality and distribution of shallow groundwater levels in drainage-impaired areas of the San Joaquin Valley;
- promoting agricultural water and energy use efficiency programs in drainage-impaired lands to reduce the volume of surface and subsurface drainage water and expand regional water supplies;

- maintaining programs to help improve water quality on the San Joaquin River; and
- providing grants for control of agricultural drainage water and the reduction of its toxic elements, using propositions 13, 50, 204, and DWR project funding.

The Agricultural Drainage Program is divided into two major activities: management of Proposition 204 (Drainage Management Subaccount) and the San Joaquin Valley Agricultural Drainage Program.

### Proposition 204 (Drainage Management Subaccount)

In 1996, Proposition 204, The Safe, Clean, Reliable Water Supply Act, authorized the transfer of approximately \$6.1 million from the State Water Resources Control Board (SWRCB) to the California Department of Food and Agriculture (CDFA). In 1997, CDFA, SWRCB, and DWR signed an MOU that established a process for utilizing the funds designated for agricultural drainage water management activities. In 1999, CDFA and DWR signed an interagency agreement to transfer the funds to DWR for developing and implementing programs consistent with Water Code Section 78645, as outlined in the MOU. The program's goal is to develop methods of using and concentrating salts and reducing trace element contaminants in the State's subsurface agricultural drainage water.

Each year, DWR solicits proposals from public entities seeking funding for research. A technical review committee (TRC) reviews and screens the proposals. DWR submits the proposal packages to an oversight committee made up of representatives from DWR, CDFA, and SWRCB for final approval. Ultimately, DWR is responsible for preparing and managing contracts for the approved

proposals. In 2007, the TRC selected the following proposals for funding:

- *High Recovery Membrane Desalting of San Joaquin Valley Brackish Water by Feed Flow Reversal RO*, University of California, Los Angeles (UCLA).
- *Identification of Key Microalgal Species for Selenium Volatilization and Biofuel Production in an IFDM Pilot System*, University of California, Davis (UCD).
- *Opportunistic Real Time Management of Saline Discharge Conjoined with San Joaquin River Restoration*, University of California, Merced (UCM).
- *Nitrogen Management Strategies that Enhance the Sustainability of Drainage Water Reuse Strategies with Canola and the Production of its Bio-based Products*, U.S. Department of Agriculture (USDA).

### San Joaquin Valley Agricultural Drainage Program

This program consists of several activities, including drainage monitoring and evaluation, drainage treatment, integrated on-farm drainage management, drainage reduction and reuse, environmental services, and the San Joaquin River Water Quality Improvement Program.

#### *Agricultural Drainage Program Tour*

In April 2007, at the Westlands Water District field office in Five Points, Agricultural Drainage Program staff presented the program's current activities to representatives from the State Water Contractors and DWR upper management. After the presentation, the group traveled to Red Rock Ranch (RRR), where they observed the various cooperative projects described in this section.

#### *Drainage Monitoring and Evaluation*

Drainage monitoring and evaluation involves collecting and evaluating information on the quality, quantity, and movement of drainage

water. In 2007, the following activities were conducted:

- Monitor shallow groundwater levels and flows, and collect water quality data for drainage water from Westside San Joaquin Valley tile drain sumps. In Kern County, groundwater levels are measured quarterly for approximately 200 wells.
- Prepare shallow groundwater and irrigation methods maps of drainage-impaired areas using drainage monitoring data in conjunction with land use and irrigation methods data.
- Provide assistance for the collection of groundwater, soil, and operational data for the integrated on-farm drainage management project at RRR in western Fresno County.
- Maintain a website that includes information on drainage programs and activities, salinity and shallow groundwater maps, Proposition 204 grants, and links related to other agricultural drainage programs (<http://www.water.ca.gov/drainage/>).

### **Drainage Treatment**

**Development of Membrane Treatment of Agricultural Drainage Water.** DWR continues to fund research on the use of membrane treatment for desalting agricultural drainage water under a multiyear contract with the UCLA Department of Chemical Engineering.

**Grassland Area Farmers: Westside Regional Drainage Plan.** DWR continues to participate in a multiagency cooperative effort with Grassland Area Farmers to comply with the objectives of the Central Valley Regional Water Quality Control Board's (CVRWQCB) *Water Quality Control Plan (Basin Plan) for the Sacramento River Basin and the San Joaquin River Basin*. One of the key components of the plan is drainage water treatment.

### **Agricultural Subsurface Drainage: Salt Recovery, Purification, and Utilization.**

DWR continues to support research into concentrating and purifying drainage salts for marketing purposes.

**Selenium Removal from Agricultural Subsurface Water.** DWR continues to participate in cooperative research with the University of California Salinity/Drainage Program (<http://lib.berkeley.edu/WRCA/WRC/>). Activities include a multiyear study for mitigating selenium ecotoxic risk in agricultural drainage systems.

**ForeverWater Distillation Unit.** Testing began on a promising new thermal desalination technology device that could be useful for desalination of agricultural drainage water. The patented device was constructed by a Fresno-based company called ForeverWater Inc. The pilot 100 gallon per hour unit featured high grade stainless steel. When in full design, it is expected to draw less than 20 watts at 440 volts 60-cycle per gallon produced. The unit was built for continuous operation with a full control panel and on/off switch, and features vapor compression heat recycling, steam stripping, distillation, and cyclone demisting. Preliminary results look promising, although the energy used during the test was nearly 100 watts per gallon. The company plans design changes to improve efficiency.

**Performance Evaluation of Combined Solar Technologies Agricultural Drainage Water Desalination and Power Production Pilot Demonstration Project in Westlands Water District.** Combined Solar Technologies (CST) of Pacific Grove, California, built a demonstration project that uses both natural gas/hydrogen-fired and solar-derived thermal energies that can both generate electricity and reclaim water. The pilot project report presented data collected from two test sites outfitted with solar-thermal/gas-powered brine reduction systems built by CST.

The pilot system at RRR was designed to treat agricultural drainage water from field irrigation. The feed-water total dissolved solids (TDS) ranged from 11,408 milligrams per liter (mg/L) to 221,000 mg/L. Tests were conducted in collaboration with DWR and UCD Department of Biological and Agricultural Engineering. The system consisted of one experimental natural gas/hydrogen-fired brine boiler, one experimental hot-fluid-type boiler, one 12-horsepower CST engine driving a 10 kilowatt (kW) generator, and one 800-square-foot parabolic trough. Testing occurred during most of 2006, processing a total of 36,902 gallons of drainage water. The majority of the water averaged a TDS of 12,000 mg/L; however, about 8,000 gallons had a TDS of 66,000 mg/L, and 250 gallons had a TDS of 223,000 mg/L. The gas-fired boiler and the hot-fluid boiler both underwent testing. Boiler efficiency ranged from 70 percent to 86 percent.

An 800-square-foot parabolic solar-concentrating array powered the hot-fluid boiler in August and September. As part of this research, a CST evaporator system prototype was field-tested using feed-water from an agricultural drainage sump.

Interpretation of the pilot test results indicate the process developed by CST can provide additional water resources through a zero liquid discharge (ZLD) reclamation process with minimal net fossil fuel-based energy inputs, possible energy output, and substantial cost savings. Boiling drainage water for power and desalination process has not been previously attempted.

### ***Integrated On-Farm Drainage Management***

DWR's San Joaquin District's Integrated On-Farm Drainage Management (IFDM) became a permanent activity when the Integrated Drainage Management Section was created in 2001. Its objective is to

provide technical assistance on IFDM systems through advisory, technical, and oversight committees. IFDM is a drainage management system based on sequential reuse of saline drainage water to irrigate crops of progressively increasing salt tolerance. Each sequential reuse reduces the volume of drainage water and increases the salt concentration. Drainage water too saline for irrigation can be applied to a variety of discharge points. The IFDM program funds, administers, and monitors contracts with State, federal, university, and local entities to learn more about IFDM systems. Findings indicate that IFDM systems have less significant environmental impacts than other options and they reduce the volume of drainage water. The program is investigating the use of accelerated evaporation systems (solar evaporators) for zero discharge systems and evaluating the feasibility of using salt-gradient solar pond systems as a way of removing salt and generating heat or electricity for agricultural use.

IFDM program staff also:

- Coordinate IFDM research activities and data collection with other agencies.
- Assist growers and local agencies in planning and developing IFDM systems.
- Investigate new techniques for zero discharge, including enhanced evaporation techniques and extraction of salts from reused drainage water at a solar still facility at RRR.
- Participate in joint investigations with Reclamation to determine the feasibility of nanofiltration as a pretreatment for desalination of subsurface drainage water using reverse osmosis (RO) technology and the feasibility of using a patented biotreatment process to remove selenium from agricultural subsurface drainage water.
- Provide assistance to research projects for the development of crops, including research being performed at RRR by

California State University, Fresno, to assess the suitability of various salt-tolerant forages and halophytes for the sequential reuse of drainage water, forage quality, productivity, and water use.

- Cooperate with the USDA in an investigation to determine crop production using an active drainage management system that employs *in situ* use of shallow groundwater and subsurface drainage water.

DWR continues to work cooperatively with Reclamation to investigate the long-term interaction of irrigation, rainfall, and local and regional groundwater with the movement of salts and selenium in the RRR soils. The project will use a three-dimensional numerical model for fully integrated subsurface and surface flow and solute transport. DWR continues to monitor a series of observation wells at RRR and surrounding areas, collect water quality samples, and measure groundwater levels to provide data for the model. Other activities include the following:

- assisting growers, water and drainage districts, and regional entities, by providing information on salt-tolerant grasses and IFDM design specifications;
- assisting SWRCB to develop policies for the management of drainage water, salt, and selenium; and
- improving enhanced evaporation features of the pilot solar evaporator.

DWR continues to collect data on evaporation rates of subsurface drainage water using dyes, nozzles, screens, and other devices and materials. The purpose is to develop design specifications for evaporating and recovering salts from drainage water in the solar evaporator, to determine optimum weather parameters to operate it, and to study methods to minimize and control potential salt drift. A white paper

summarizing results of previous research was released (<http://www.water.ca.gov/drainage/ifdm/downloads.cfm>).

DWR continues to assist Reclamation with performing project tasks for the HydroGeoSphere project at RRR. To facilitate development of the conceptual model, DWR staff collected topographic survey data of RRR and the surrounding area to determine elevation points and to locate fixed works such as sumps, pumps, and wells. Model results from this case study will be useful for the formulation of optimal design and management guidelines for IFDM systems.

DWR is continuing research on *Prosopis alba*, an Argentine mesquite tree, in cooperation with the Forestry Research Station at Catholic University of Santiago del Estero (CUSE) in Argentina. *Prosopis alba*, which originated from the plantations of CUSE, is a highly salt-tolerant tree species that holds promise for ameliorating subsurface drainage problems in western San Joaquin Valley soils. There is good potential for investment of the agriforestry component in an IFDM system. The lumber is coveted by the furniture industry in Argentina and has a value of \$1,000 per ton of sawn lumber. Research and development is needed to perfect the process for the reliability of massive production of elite *Prosopis alba* for large-scale reforestation. CUSE provided approximately 2,000 scarified *Prosopis alba* seeds to initiate plantation trials in the San Joaquin Valley. After inspection and quarantine in a USDA facility, the seeds were taken to a plant nursery to produce plants needed for trials at five locations within drainage-impaired lands.

DWR staff continues to collect operational data from IFDM projects at RRR and AndrewsAg for analysis of performance. DWR staff provided technical information and assistance on an agriforestry planting program in Kern County on farms with salinity and shallow groundwater problems.

**Saline Drainage Water can be Managed by Growing Forages.** In a project funded in part by Proposition 204, UCD continues to evaluate drainage water reuse. At a 30-hectare site in Kings County, saline-sodic drainage and other wastewaters are being used for forage and livestock production. Bermuda grass (*Cyanodon dactylon*) was planted in 1999 and grazed rotationally. Livestock trials were carried out for 3 years (2001–2003). Irrigation and grazing has continued up to the present. Forage sampling occurred at sites reflecting soil variation. Samples were analyzed for quality and mineral content. Bermuda grass grew well at moderate salinity levels. No adverse livestock health effects were observed. More recent work focuses on the use of crop simulation modeling to explore the yield potential of Bermuda grass under saline irrigation and other soil conditions.

### **Central Valley Salinity Management Program**

In 2006, CVRWQCB and SWRCB initiated a comprehensive effort to address salinity problems in California's Central Valley and adopt long-term solutions that would lead to enhanced water quality and economic sustainability. The Central Valley Salinity Alternatives for Long-Term Sustainability (CV-SALTS) is an effort to develop and implement a comprehensive salinity management program. The CV-SALTS goal is to maintain a healthy environment and a good quality of life for all Californians by protecting our most essential and vulnerable resource: water. DWR is involved in the process by providing expertise in salinity management through participation in the committees and activities of the Central Valley Salinity Policy Group. This group provides guidance and technical support on specific issues (Technical Advisory Committee, Social and Economic Impact Study Committee, and Public Education and Outreach Committee) and overall direction and management (Steering Committee) for

the development of a comprehensive Central Valley Salinity Management Plan.

### **Drainage Reduction and Reuse Program**

DWR's Drainage Reduction and Reuse Program offers technical assistance, information, and other resources to growers and irrigators for applying irrigation water efficiently to reduce both excessive deep percolation and drainage water from the immediate on-farm source, while maintaining salt balance in the root zone.

The program objective is being achieved through on-farm demonstration projects, studies, research, training, and workshops on scheduling irrigation, management, advances in irrigation technologies, evaluating irrigation systems, reusing drainage water, and managing salinity.

### **Environmental Services**

DWR's San Joaquin District Environmental Services Section investigates and reports on short- and long-term use and operation of evaporation ponds, IFDM, and other systems used for disposal and management of drainage water. Environmental investigations include the following:

- RRR research projects that involve required biological monitoring activities in accordance with Waste Discharge Requirements permits;
- assisting landowners in locating information required for preparing California Environmental Quality Act (CEQA) documentation necessary for obtaining permits and authorization for implementing, monitoring, and operating drainage reduction, treatment, and disposal projects;
- mapping agriforestry and herbaceous plots in drainage-impacted areas, using global positioning system (GPS) technology, which is then imported into a geographic information system (GIS) format linked to a database created to

track key information associated with development of the vegetation plots;

- responding to information requests from landowners wanting a better understanding of the CEQA and the National Environmental Policy Act (NEPA) public review process, so they can more meaningfully comment on upcoming State and federal drainage related projects; and
- reviewing quarterly and annual environmental monitoring reports related to evaporation pond operation and investigation.

**Wetlands Study.** As per CVRWQCB data, wetlands discharges contributed about 9 percent of the total salt load in the San Joaquin River at Vernalis. The contribution is likely to be higher today as additional water supply and land are acquired for wetlands wildlife refuges through the Central Valley Project Improvement Act (CVPIA), Environmental Water Account (EWA), and other programs. Timing of wetlands releases with assimilative capacity of the San Joaquin River could result in significant water quality improvements. However, little has been done in this regard due to concerns over disrupting existing, proven wetlands management practices.

Research is underway to determine if improved wetlands management practices can be achieved for the benefit of both wildlife and San Joaquin River water quality. Current research has focused on real-time water quality monitoring and adaptive management. Research goals are to coordinate timing of wetland discharges when assimilative capacity is available. In addition to funds provided by CALFED for the study of the *Effect of Delayed Wetlands Drawdown on Moist Soil Plants*, DWR is collaborating with the Department of Fish and Game (DFG) and private wetlands in a study to assess other aspects of delayed wetlands drawdown. The studies on delayed wetlands drawdown will be complemented

by a study funded by DWR under Proposition 204.

DWR's San Joaquin District Environmental Services Section, in a collaborative effort with DFG and other entities, is collecting biological data in seasonal San Joaquin Basin wetlands within the Grasslands Ecological Area. Information collected will be used in determining management actions that will create the opportunity for blending saline west-side and agricultural return flows with high quality east-side reservoir releases into the San Joaquin River. The objective is to improve compliance with State water quality objectives while protecting wetlands ecosystem integrity.

Wetlands managers typically begin draining managed wetlands (a primary source of saline discharge) in mid-to-late March, the same time that farmers need relatively high quality water for irrigation of salt-sensitive crops. However, modifying water release to a later drawdown date (mid-to-late April) during the San Joaquin River's assimilative capacity could be detrimental to wetlands ecosystem health. Timing and duration of drawdown is planned for optimum germination and seed production of swamp timothy (*Crypsis schoenoides*), a plant that is widely managed for, and preferentially selected by, some waterfowl and shorebirds.

Swamp timothy seed production is being estimated through soil core sampling. Six paired wetlands sites are being studied to compare the potential changes in wetlands vegetation associated with a late drawdown date. Sampling started in fall 2006 and will be continue to be taken through spring 2009. Meetings were conducted with staff from the Grassland Water District and DFG. Scientific sampling began in fall 2007.

### **San Joaquin River Water Quality Improvement Program**

DWR's Agricultural Drainage Program, in collaboration with other agencies, continues

its significant efforts to improve water quality in the San Joaquin River to benefit the State and DWR water contractors. These efforts are intended to control salinity and selenium discharges upstream of Vernalis. They include promoting on-farm and regional water management to reduce subsurface drainage, real-time water quality management to maximize the assimilative capacity of the San Joaquin River, and timing wetlands discharges for when there is assimilative capacity in the San Joaquin River.

***On-Farm and Regional Drainage Management Activities.*** Drainage management involving source control and drainage reuse has proven effective in reducing salt loads in the San Joaquin River. This is demonstrated by the efforts of the Grassland Area Farmers on the Grassland Bypass Project (GBP). Since GBP implementation, drainage discharges have decreased from 58,000 af to about 30,000 af, and salt loads have been reduced from 210,000 tons to 117,000 tons. The reductions are possible because DWR funded, through Proposition 13, an important GBP component, the San Joaquin River Improvement Project. The project consists of about 4,000 acres of lands dedicated for reuse of subsurface drainage water generated by Grassland Area Farmers to grow salt-tolerant crops. DWR continues providing technical assistance for improving and developing this important part of the GBP project.

DWR collaborates with many entities in efforts to control, reduce, or eliminate drainage water discharges into the San Joaquin River. Such efforts include the West Side Regional Drainage Plan, Reclamation's San Luis Drainage Feature Reevaluation to provide drainage service to the San Luis Unit of the Central Valley Project (CVP), and the IFDM program maintained by DWR and collaborating agencies.

***Real-Time Water Quality Monitoring Program.*** The Real-time Water Quality Monitoring Program (RTWQMP) collects flow, EC, and temperature data from several satellite-linked and web-accessible stations on the mainstem of the San Joaquin River and its tributaries to forecast flow and water quality conditions. The information provided can be used by San Joaquin River water managers and stakeholders for improving management and coordination of eastside reservoir releases and agricultural and wetland drainage flows, to achieve water quality objectives at San Joaquin River compliance points. In the early stages, the RTWQMP was funded by Reclamation and then by CALFED. Currently, DWR has assumed responsibility for funding most of the RTWQMP for the San Joaquin River.

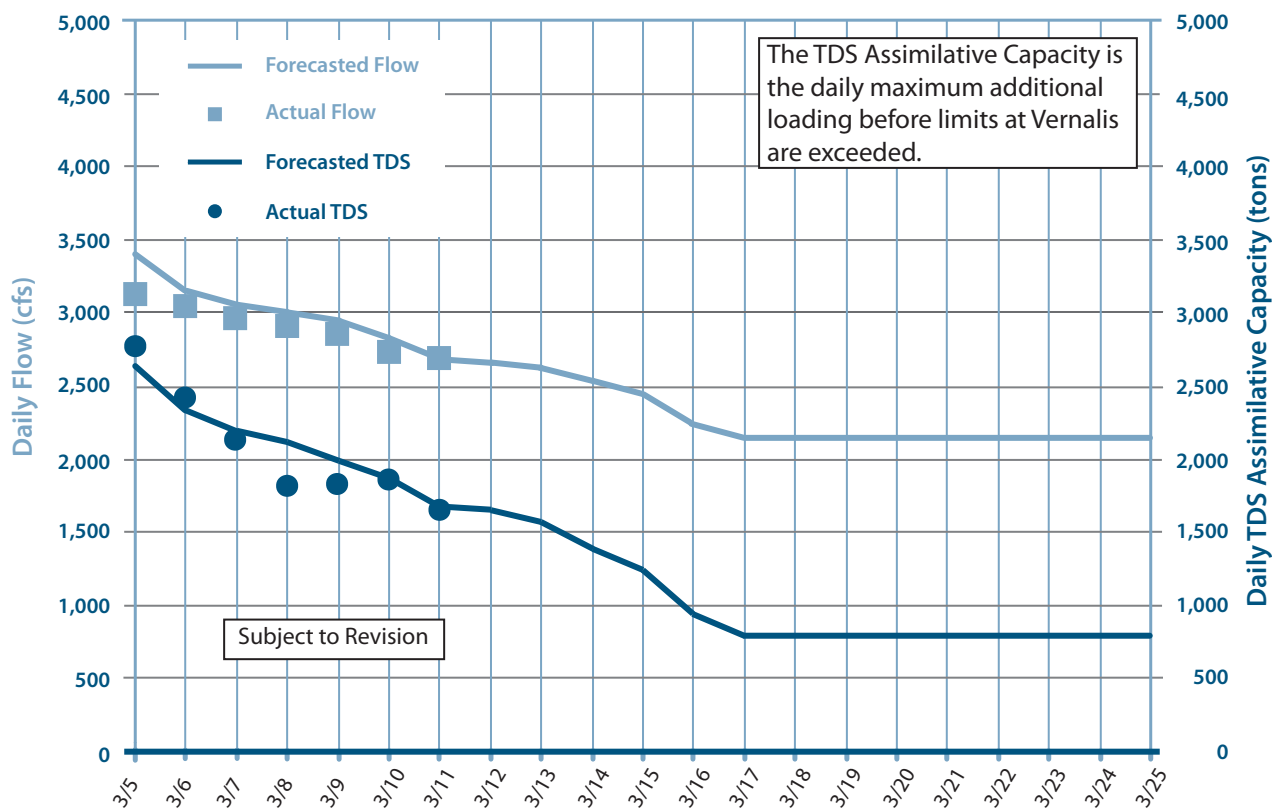
Forecasting flow and salinity conditions on the San Joaquin River, allows decision makers to take advantage of assimilative capacity of the river when available. Data collected from the network of monitoring stations is used with the San Joaquin River Input-Output Day (SJRIODAY) model to generate biweekly forecasts of salinity and flow conditions on the river near Vernalis and other upstream stations. DWR publishes the information weekly on its website. Figure 5-1 shows an example of the information generated.

In October 2007, DWR met with Reclamation, RWQCB, and other interested parties to establish the Real-time Management Partners. This multiagency group works cooperatively to make real-time management a viable tool to manage discharges of salinity sources to benefit the water quality of the lower San Joaquin River and the Delta.

***Concepts for Collaboration Drainage Resolution Issues.*** Given the uncertainty and timing of implementation of drainage service to the CVP San Luis Unit service



### Vernalis Total Dissolved Solids (TDS) Assimilative Capacity—Week 3/12/07



**Figure 5-1 San Joaquin River Input-Output Day Modeling Forecast Example**

area, Reclamation, and the federal water contractors began a Collaborative Resolution effort along with State and environmental interests to explore creative alternatives for resolving drainage issues. The concepts discussed included an alternative which would relieve Reclamation of their obligation to provide drainage to the San Luis Unit by having water service contractors assume responsibility for providing a drainage program in their respective service areas. The concepts discussed included: means of providing drainage; relieving of capital obligations; transferring water facilities or water rights to local entities; restrictions on water right Permit No. 12860; CVPIA restoration fund payments; points of

delivery; environmental benefits; and effects on Reclamation’s legal obligations including environmental compliance. DWR participated in the discussions as an interested observer, and identified a number of issues with this proposal that could affect the SWP.

**International Water Technology Transfer Conference in Riverside, California.** The Agricultural Drainage Program staff prepared a poster for the conference. The poster included an illustration of research, development, and demonstration projects providing useful technologies in managing agricultural drainage water and drainage-related effects.

Featured projects include the following:

- design of the Integrated on-Farm Drainage Management (IFDM) system and solar evaporator;
- methods to remove selenium and other constituents found in drainage water;
- selection of salt-tolerant forages for quality and productivity;
- methods for salt separation, purification, and utilization;
- characterization and utilization of saline biomass;
- planting trials of *Prosopis alba*;
- application of HydroGeoSphere, a three-dimensional numerical model; and
- demonstration of brine boiler and solar thermal concentration system.

**Salinity Objectives in the South Delta.** Staff from the Agricultural Drainage Program continued to participate with a DWR team in relation to the SWRCB public process to review salinity objectives in the South Delta. Activities included discussions and revisions of strategies and preparations for multiple SWRCB meetings on the subject; documents submitted to SWRCB regarding southern delta salinity objectives; funding sources establishing objectives and methods of implementing them, a draft plan by the San Joaquin River Group Authority (SJRGA) on process with SWRCB, coordination with other organizations SWC, Reclamation, CVP contractors, SJRGA; and development of specific comments and presentations for DWR to make to SWRCB. Agricultural Drainage Program staff has been working with the Grassland Area Farmers to help them reduce subsurface agricultural drainage water discharges into the San Joaquin River.

**An Economic Analysis of Solar Evaporators and Evaporation Ponds.** The University of California performed an economic analysis of solar evaporators and evaporation ponds. From a construction perspective, the solar evaporators are slightly more expensive due

to the costs associated with the catchment basin. From an engineering perspective, the costs associated with reporting waste under the evaporation pond option result in substantially larger cost differences. From an annual O&M perspective, operating evaporation ponds is somewhat more expensive than solar evaporators.

Also, as the amount of drainage requiring disposal increases, the average cost for disposal decreases. This result is consistent across all farm sizes, interest rates, and hazing requirements analyzed, and suggests that the capital costs are indeed a large part of the costs of operating these drainage options. As the amount of drainage water requiring disposal continues to increase, the cost curves will level out. A flexible model was generated for evaluating the costs of implementing a solar evaporator versus an evaporation pond.

Among other factors, the model allows the user to vary the size of the farm, the drainage distribution, environmental issues, and the types of costs to consider. A general observation, based on the costs analyzed in this report, is that solar evaporators are a more cost-effective alternative than evaporation ponds.

The next phase in the analysis would be to develop a more general average cost function by acre of disposal and drainage water disposed to serve as inputs into a larger regional agricultural programming model. While the cost comparison between these two alternatives is unlikely to change (i.e., solar evaporators will be less expensive than evaporation ponds), a more accurate assessment of the costs of disposing of drainage water could be determined.

**Use of Solar Evaporators for Drainage Management—Senate Bill (SB) 1347.**

SB 1347 was passed by the Legislature and signed by the Governor in September 2006. The bill amended and added sections

of Health and Safety Code, Article 9.7 Integrated On-Farm Drainage Management (IFDM). This bill added or revised definitions, regulations, and procedures pertaining to the operation of solar evaporators. The solar evaporator is the final component of the IFDM system to evaporate all drainage water and isolate the salt. The IFDM system was developed to improve drainage conditions and reduce salt accumulation in soils. Implementation of IFDM technology has demonstrated the cultivation of higher value crops and increased yields through soil improvement of salt-laden lands. The IFDM system is a viable alternative for landowners who may not choose to participate in a voluntary land retirement program for drainage-impacted lands. Additionally, the IFDM system has been implemented to eliminate discharge of agricultural drainage water to evaporation ponds.

This legislation is of interest to DWR because of its involvement with agricultural drainage issues, specifically Integrated Drainage Management (IDM) program activities. In cooperation with RRR and the Westside Resource Conservation District (WRCD), DWR developed a solar evaporator pilot demonstration project or module at RRR. Over a 3-year period, multiple methods of operation were tested at various stages to optimize the operation of the pilot solar evaporator. Data collected during the pilot demonstration phase were used to develop plans and specifications for a full capacity farm-scale solar evaporator. The research, development, and demonstration of IFDM has advanced the science, technology, and benefits to water managers, individual growers, and political leaders throughout the San Joaquin Valley by providing a practical example of integrated farming and engineering methods to protect the quality of rivers, surface and groundwater resources, soils, and the environment.

SB 1347 received the support of the WRCD, Community Alliance with Family

Farmers, and Association of California Water Agencies (ACWA). The bill text and chaptered version can be viewed at [http://www.leginfo.ca.gov/cgi-bin/postquery?bill\\_number=sb\\_1347&sesss=0506&house=B&author=machado](http://www.leginfo.ca.gov/cgi-bin/postquery?bill_number=sb_1347&sesss=0506&house=B&author=machado).

**Lysimeter Studies.** Drainage funding supported in-part the on-going lysimeter studies of shallow-rooted truck crops at the West Side Research and Extension Center (WSREC), Five Points. The study uses two recently installed lysimeters: one monitors the evapotranspiration of a large field of grass that serves as an irrigation scheduling reference crop; the other is in a field that is rotated into various common locally grown, shallow-rooted crops. The most recent crop studied was garlic.

Detailed evapotranspiration studies of shallow-rooted crops will allow for the determination of seasonal crop water use, water supply thresholds, and ultimately, the development of crop coefficients that will be transferable for use throughout West Side irrigated agriculture. Using these crop coefficients will allow growers to more efficiently apply irrigation water, reduce drainage, and enhance yields. Crops studied using the lysimeter in previous years included head lettuce, broccoli, and peppers. This funding is also allowing further study and refinement of a reference grass crop located in the San Joaquin Valley and its correlation to CIMIS-based grass reference estimates. The results should allow for better calibration of local CIMIS disseminated  $ET_0$  used by local agriculture to schedule crop irrigation.

**San Luis Unit Drainage Management Monitoring, Compliance, and Adaptive Management Plan—United States Fish and Wildlife Service Office—Sacramento.** The U.S. Fish and Wildlife Service (USFWS) developed the draft Conceptual Monitoring, Compliance, and Adaptive Management Plan for the San Luis Unit Drainage Management

Plan (Conceptual Monitoring Plan) to start the process for addressing resource impacts and the need for a drainwater monitoring and compliance plan. The Sacramento Fish and Wildlife Office coordinated with stakeholders to develop the plan with review and input from State (including DWR) and federal agencies, Westlands Water District and others. Reclamation's 2006 final environmental impact statement (EIS) for the San Luis Drainage Feature Reevaluation (SLDFR) identified a drainage plan. In 2007, Westlands proposed an alternative drainage plan based on the selected alternative in the 2007 record of decision (ROD) for the SLDFR EIS. The Conceptual Monitoring Plan compares and contrasts the SLDFR ROD and Westlands plan alternatives and recognizes issues that need to be resolved before a detailed monitoring and compliance plan can be completed. Acknowledging that a complete drainage plan project description with details on size, location, and management of facilities is not available, the Conceptual Monitoring Plan identifies assumptions, guiding principles, and objectives for developing a framework for a monitoring plan and describes project designs, regulations, guidelines, and triggers appropriate for the plan.

***Critical Process Requirements for Membrane Desalination of Agricultural Drainage in the San Joaquin Valley.*** In November 2007, UCLA completed the report under Proposition 204 funding and with DWR staff collaboration. The study investigated the potential use of RO desalting for reducing brackish agricultural drainage discharge salinity and thus provide for the reclamation and reuse of this water. A systematic approach was developed to determine product water recovery limits with respect to the source water chemistry. This approach used thermodynamic solubility analysis and diagnostic RO scaling experiments.

Analysis of available San Joaquin Valley water quality monitoring data revealed

substantial seasonal and spatial water quality variations. Water sources in a number of locations were nearly saturated with gypsum. Theoretical analysis of RO recovery limits due to mineral scaling of certain salts (e.g., calcite, gypsum, and silica) suggested that RO recovery would be limited to between 54 percent to 68 percent. The analysis also revealed that if limitations due to mineral scaling could be alleviated, recovery limits resulting from osmotic pressure would be relatively high.

The analysis was supplemented by experiments using field water samples from five different San Joaquin Valley locations. The selected locations were representative of the range of water compositions throughout the San Joaquin Valley. Membrane RO desalination test results were in reasonable agreement with recovery limits estimated through thermodynamic solubility analysis. RO desalination is a feasible technology for desalting San Joaquin Valley drainage water.

Given the spatial and temporal water quality in the San Joaquin Valley, a distributed system of desalination facilities would be the most appropriate approach for field-scale deployment of RO desalination. Such systems would require effective monitoring and mitigation technologies. Pilot field studies would be necessary in order to evaluate the ability of RO to operate at reasonable recoveries and handle variable water quality.

***Zero Liquid Discharge for Inland Desalination.***

The project objective was to investigate technologies with the potential to reduce the cost and energy consumption for inland desalination with zero liquid discharge (ZLD). The core challenge is developing more economical methods for managing desalination concentrate without discharge from the site. The established technologies are thermal desalination and evaporation ponds. The capital cost for each is high and thermal desalination is very energy intensive.

Given the disadvantages of established ZLD technologies, it was important to investigate membrane desalination for concentrate treatment. However, unlike thermal desalination, membrane desalination cannot be used to recover concentrate without first treating the concentrate to reduce its precipitation potential. Furthermore, not all of the concentrate can be recovered by membrane desalination, and the residual must still be treated with downstream processes such as thermal desalination and evaporation in ponds. Consequently, the ZLD process train proposed in this research comprised the following: primary RO concentrate treatment process or processes, secondary RO, brine concentrator (thermal desalination), and an evaporation pond.

This report establishes parameters for ZLD treatment performance and cost based on water quality characteristics. A simple procedure for calculating feasibility level costs for ZLD concentrate treatment is presented. Utility managers can use this information as a basis for deciding whether to proceed with a desalination feasibility study. The report was prepared by Black & Veatch Corporation, and jointly funded by the Water Research Foundation and the California Energy Commission, under Agreement 3010. Agricultural Drainage Program staff participated in the technical review of the report as a member of the Project Advisory Committee for this project.

## Environmental Impact Document Review

The Environmental Document Review Section in DWR's Division of Environmental Services screens State Clearinghouse documents and circulates SWP-related materials for review by DWR's four regional offices in the Division of Integrated Regional Water Management (DIRWM), Division of Operations and Maintenance (O&M), and the Division of Engineering. Other divisions and

offices are notified of activities and are asked to comment when their expertise is required.

Some environmental impact documents handled by the State Clearinghouse concern proposed activities that would affect the SWP. State Clearinghouse documents are regularly reviewed to identify any public safety or liability issues arising from the proposed activities.

From January through December of 2007, 4,117 documents were screened by the Environmental Document Review Section; 1,073 were referred for detailed review. Of these referrals, 750 assignments were made when the projects were at the Notice of Preparation or Early Consultation stage and 119 assignments were for negative declarations, CEQA environmental impact reports, and NEPA environmental impact statements. O&M received 142 formal referrals and one for information. The State Water Project Analysis Office (SWPAO) received 15 formal referrals and 6 for information. In addition to the information referrals made to O&M and SWPAO, 767 other information referrals were made to other DWR staff.

DWR comments submitted to the CEQA or NEPA lead agencies addressed a number of issues, including runoff from proposed developments; safety and water supply; encroachment on physical facilities; impacts to cross drainage facilities; and proposed plans to acquire, convey, sell, and transfer SWP water. During 2007, several requests for additional data were made to lead agencies when the environmental document did not contain enough information. Additional departmental actions, involving encroachment permit submittals and informal comments, took place but were not tracked by the Environmental Document Review Section. During 2007, 14 projects involving tribal gaming issues were assigned to the DIRWM for review. These projects are of special concern to the State and require a

specific review process. While none of these projects affected the SWP in 2007, they have a potential for causing future concerns.

During 2007, the Environmental Document Review Section tracked documents related to development along the California Aqueduct, levee encroachment, water transfers and other water supply issues, wastewater treatment, quarry development, electrical transmission lines near SWP facilities, and development of a high speed rail network.

In 2007, referrals were down by 17 percent from 2006. Part of this reduction may be due to a 9 percent decrease in documents received from the State Clearinghouse. Part of this reduction may also be attributable to an increase in administrative-type projects such as master plans, implementation plans, and transportation plans, a 60 percent increase over 2006—from 79 to 127 combined, and others, as many of these documents would be of little or no interest to DWR.

## Water Conservation Bond Laws

To assist local agencies in obtaining financing for their water management programs, California voters approved eight bond laws between 1984 and 2006 authorizing DWR to provide low-interest loans and grants to fund project feasibility studies or construction activities.

- The Clean Water Bond Law of 1984 (Proposition 25) authorized \$10.5 million for water conservation projects.
- The Water Conservation and Water Quality Bond Law of 1986 (Proposition 44) authorized \$75 million for water conservation and groundwater recharge projects.
- The Water Conservation Bond Law of 1988 (Proposition 82) authorized \$60 million for water conservation,

groundwater recharge, and new local water supply improvements.

- The Safe, Clean, Reliable Water Supply Act of 1996 (Proposition 204) authorized \$55 million for water conservation, groundwater recharge, and local water supply projects.
- The Safe Drinking Water, Clean Water, Watershed Protection and Flood Protection Bond Act of 2000 (Proposition 13) authorized \$535 million for agricultural and urban water conservation, groundwater recharge, infrastructure rehabilitation, groundwater storage, and interim reliable water supply projects and studies.
- The Water Security, Clean Drinking Water, Coastal and Beach Protection Act of 2002 (Proposition 50, Chapter 8) authorized \$500 million for the Integrated Regional Water Management (IRWM) grant program to be implemented jointly by DWR and SWRCB.
- The Safe Drinking Water, Water Quality and Supply, Flood Control, River and Coastal Protection Bond Act of 2006 (Proposition 84), approved by the voters in the November 7, 2006, General Election, authorized \$1 billion for IRWM Planning and Implementation.
- Disaster Preparedness and Flood Prevention Bond Act (Proposition 1E), passed by voters November 2006, provides \$300 million for IRWM Stormwater Flood Management.

Under these programs, grants and construction loans are available with repayment of up to 20 years at reduced interest rates for most programs.

### Propositions 25, 44, and 204

Funding is fully obligated.

### Proposition 82

Water supply loan funding is still available.

### **Proposition 13**

Agricultural water conservation loan funding is still available.

All loan and grant funds for the Groundwater Recharge, Infrastructure Rehabilitation, Urban Water Conservation, Groundwater Storage, and Interim Reliable Water Supply programs have been obligated.

### **Proposition 50**

In 2007, DWR and SWRCB awarded approximately \$307 million dollars to 16 agencies in the first round of IRWM implementation grants. Of the \$307 million, DWR awarded \$157 million. DWR and SWRCB developed guidelines and a PSP for the second round of funding for implementation grants. Draft guidelines and a PSP for Round 2 were released in April 2007, and the final versions were released in June 2007.

### **Propositions 84 and 1E**

Staff continued developing the IRWM grant program, funded by Proposition 84 and Proposition 1E, which included performing public scoping meetings. In addition to other approval criteria for most of the Water Conservation Bond Law programs, applicants must demonstrate that project benefits equal or exceed project costs. Typical projects fall under the following categories.

#### ***Local Water Supply***

Projects in this category are constructed to increase water supplies, and include new conveyance and/or storage facilities; groundwater extraction facilities, well-field development; and desalination facilities (ocean or brackish groundwater recovery).

#### ***Integrated Regional Water Management***

Projects in this category protect communities from drought, protect and improve water

quality, and improve water security by reducing dependence on imported water.

### **Water Conservation Bond Laws— Projects and Funding**

Table 5-1 totals the number of projects and funds committed for each of the water bond laws through December 2007.

**Table 5-1 Cumulative Water Conservation Bond Laws—Projects and Funding through 2007**

<b>Bond Law</b>	<b>Bond Law Subaccount (Type of Project)</b>	<b>Number of Projects<sup>a</sup></b>	<b>Funding<sup>a</sup> (millions of dollars)</b>
Clean Water Bond Law of 1984 (Prop 25)	Water Conservation	7	9.74
Water Conservation and Water Quality Bond Law of 1986 (Prop 44)	Water Conservation	24	41.60
	Groundwater Recharge	10	28.04
	<i>Subtotal</i>	34	69.64
Water Conservation Bond Law of 1988 (Prop 82)	Water Conservation	7	17.44
	Groundwater Recharge	8	24.30
	Local Water Supply	5	11.90
	<i>Subtotal</i>	20	53.64
Safe, Clean, Reliable Water Supply Act of 1996 (Prop 204)	Water Conservation	2	7.00
	Groundwater Recharge	5	22.10
	Local Water Supply	23	23.48
	<i>Subtotal</i>	30	52.58
Safe Drinking Water, Clean Water, Watershed Protection and Flood Protection Bond Act of 2000 (Prop 13)	Agricultural Water Conservation	13	1.18
	Urban Water Conservation	54	28.00
	Groundwater Recharge	24	28.30
	Infrastructure Rehabilitation	42	56.40
	Groundwater Storage	41	180.00
	Interim Reliable Water Supply	13	169.31
<i>Subtotal</i>	187	463.19	
Water Security, Clean Drinking Water, Coastal and Beach Protection Act of 2002 (Prop 50)	Local Groundwater Assistance	84	18.40
	Integrated Regional Water Management	45	176.49
	<i>Subtotal</i>	129	194.89
<b>Total of All Projects</b>		<b>407</b>	<b>843.68</b>

<sup>a</sup> Construction and feasibility study loan and grant commitments as of December 31, 2007.





## Chapter 6 Legislation and Litigation

*Flags flying at the California State Capitol.*

## Significant Events in 2007

**S**ignificant legislation coordinating the collection, management, and use of water measurement data passed in 2007. While these bills do not directly impact the State Water Project (SWP) or project operations, they may impact SWP contractors or their customers.

*Information for this chapter was provided by the Assistant Director, Legislative Affairs Office, and the Office of the Chief Counsel.*

The Department of Water Resources (DWR) monitors State and federal legislation that affects management of the State Water Project (SWP). Legislative bill tracking involves reviewing legislation at its introduction, evaluating amendments in State Assembly and Senate committee hearings, and monitoring its enactment into law. The DWR Assistant Director for Legislation monitors proposed legislation. The Office of the Chief Counsel tracks State and federal litigation that impacts management of the SWP. The DWR Chief Counsel also manages legal cases that involve SWP operations.

## Legislation

### State Legislation

No legislation directly impacting the SWP or SWP operations passed in 2007. However, the following 2007 bills could affect SWP contractors or their customers.

#### ***AB 1404 (Laird) Water Measurement Information (Chapter 675, Statutes of 2007)***

This bill requires DWR, the State Water Resources Control Board (SWRCB), the CALFED Bay-Delta Program (CALFED), and the State Department of Public Health to coordinate the collection, management, and use of water measurement information. It also requires these agencies to prepare and submit a report to the Legislature evaluating the feasibility of developing a coordinated water measurement database. The bill requires agricultural water suppliers to report water delivery data, and it conditions eligibility for specific grants or loans on compliance with these reporting requirements.

#### ***AB 1406 (Huffman) Recycled Water: Toilet and Urinal Flushing: Condominiums (Chapter 537, Statutes of 2007)***

This bill permits the use of recycled water in condominium projects that are created on or after January 1, 2008, as currently used in apartment buildings.

#### ***AB 1420 (Laird) Water Demand Management Measures: Water Management Grant or Loan Funds (Chapter 628, Statutes of 2007)***

This bill requires urban water suppliers to implement demand management measures (DMMs) described in the urban water management plan in order to be eligible for specified water management grants and loans. This bill requires DWR to convene an independent panel to provide recommendations to the Legislature on new DMMs (conservation measures), technologies, and approaches.

### Federal Legislation

There was no significant federal legislation affecting management of the SWP in 2007.

## Litigation

As of December 31, 2007, DWR was involved in, or closely monitored, a number of court cases and other actions related to the management of the SWP.

#### ***Sacramento-San Joaquin Delta Delta Smelt***

Previously, a coalition of environmental groups challenged the biological opinion issued by the U.S. Fish and Wildlife Service (USFWS) which found that SWP and Central Valley Project (CVP) operations did not jeopardize the continued existence

of the delta smelt. (*Natural Resources Defense Council, et al. v. Gale A. Norton, et al.* (U.S. District Court for the Eastern District of California, 2005, Case No. 05 CV 01207 OWW (LJO)).) In the new action of *Natural Resources Defense Council, et al. v. Kempthorne, et al.*, the plaintiffs claim the USFWS opinion fails to adequately consider or address the effects on delta smelt provided in soon-to-be-renewed long-term water service contracts. The plaintiffs also claim the opinion improperly relies on uncertain future mitigation measures and the adaptive management process without adequate evidence that the measures will be undertaken and be effective. The case seeks to have the U.S. Department of the Interior and USFWS withdraw the opinion and not take any action in reliance upon it.

DWR intervened to protect its interests in the biological opinion relevant to the operations of the SWP, filing an answer to an amended complaint on October 24, 2006. Deadlines were set for filing motions for summary judgment for the end of December 2007, with hearings scheduled for March 2008.

Another similar case was filed October 4, 2006, *Watershed Enforcers, a project of California Sportfishing Protection Alliance, a non-profit corporation v. California Department of Water Resources, Lester Snow, Ralph Torres, David Starks, David Duval and L.D. Elmore* (Alameda County Superior Court, Case No. RG06292124). Watershed Enforcers asserts that DWR lacks authority for the losses, also known as “take,” of the endangered delta smelt and winter- and spring-run salmon. DWR believes that a number of agreements/plans starting as early as 1986 with the Department of Fish and Game (DFG) provide for SWP compliance with the California Endangered Species Act (CESA) and the federal Endangered Species Act (ESA) allowing “incidental take” of these fish. For the past 12 years, DWR has been operating the SWP while actively addressing and mitigating environmental impacts,

including incidental take. Plaintiffs claim that DWR is not operating consistent with CESA because it has not obtained a permit, a consistency determination, or completed a conservation plan. On March 22, 2007, the court gave DWR 60 days to obtain take authorization from DFG. DWR appealed. The parties also negotiated a joint motion for stay of the appeal through December 2008 to coordinate the federal biological opinion reconsultation and issuance of a new biological opinion by the end of 2008. DWR will then seek a consistency determination from DFG, in effect mooting the appeal.

In another case (*Pacific Coast Federation of Fishermen's Associations/Institute for Fisheries Resources, The Bay Institute, BayKeeper, and Its Deltakeeper Chapter, California Trout, Friends of the River, Natural Resources Defense Council, Northern California Council of the Federation of Fly Fishers, and Sacramento River Preservation Trust, all non-profit organizations and the Winnemem Wintu Tribe v. Carlos M. Gutierrez, in his official capacity as Secretary of Commerce, William T. Hogarth, in his official capacity as Assistant Administrator for Fisheries, National Marine Fisheries Service, National Oceanic and Atmospheric Administration, Dirk Kempthorne, in his official capacity as Secretary of the Interior, and William E. Rinne, in his official capacity as Acting Commissioner, United States Bureau of Reclamation and (Intervenors/Defendants) San Luis & Delta Mendota Water Authority, Westlands Water District, California Farm Bureau Federation, Glenn-Colusa Irrigation District, et al. and State Water Contractors, et al*), the plaintiffs, nine environmental groups, served a 60-day notice to the federal defendants, NOAA, of alleged violations of ESA on May 31, 2006.

DWR was not named as a defendant in this case and has not intervened as party defendants in this matter, although it intends to do so in the remedy stages of the case, providing similar input and contribution to the delta smelt case. The defendants in this

case attempted to consolidate the smelt and salmon/steelhead cases but the motion was denied. The smelt litigation went forward and an interim remedy order was issued on December 14, 2007. A similar litigation path is anticipated in this case.

Plaintiffs' amended complaint alleges that the survival and population stability of five salmon and steelhead species are threatened by the current and planned joint operations of the CVP and SWP. Plaintiffs allege the operations of the water projects continue to block fish passage to hundreds of miles of upstream spawning and rearing habitat; further reduce and degrade the remaining habitat due to water diversions; create high temperatures and changes in dissolved oxygen ratios and silt load; and draw large numbers of fish into the Central and South Delta as a result of operations of the Delta Cross Channel and the CVP and SWP pumps. Plaintiffs claim a percentage of salmon and steelhead are killed through direct entrainment from project water diversions and from other unscreened diversions resulting in a lower survival rate. Plaintiffs request the court declare the 2004 CVP/SWP Operations Opinion unlawful and issue an injunction from implementation of project operations as described in the 2004 opinion.

A motion for summary judgment was heard before federal Judge Wanger on October 3, 2007. The judge has taken this matter under submission since conclusion of the hearing and advised the parties that he will issue an order after finalizing the order in the related smelt case.

### ***State Water Resources Control Board Hearing***

In February 2005, DWR and the Bureau of Reclamation (Reclamation) petitioned the State Water Resources Control Board (SWRCB). This petition requested a temporary change and delay of the effective date to implement the southern Delta

agricultural water quality objective contained in SWRCB's Water Right Decision 1641 (D-1641). This objective was scheduled to begin on April 1, 2005. A second petition was submitted to request a change of the implementation date to April 1, 2008. (This date matches the date the southern Delta permanent gates are scheduled for operation.) SWRCB denied the first petition. No action was taken on the second petition.

On May 3, 2005, SWRCB notified DWR and Reclamation of its intention to issue a cease and desist order. This requested order sought to stop a potential violation of the southern Delta agricultural water quality objective of 0.7 millimhos per centimeter (mmhos/cm) electrical conductivity (EC) by DWR and Reclamation. This water quality objective was scheduled to be in effect annually, from April 1 through August 31, beginning in 2005. D-1641 conditioned the operation of the SWP and CVP with implementation of this agricultural objective. DWR and Reclamation requested a hearing on the cease and desist order. In October and November 2005, DWR and Reclamation presented evidence and argued that the cease and desist order should not be issued.

On February 15, 2006, SWRCB issued a cease and desist order requiring DWR and Reclamation to take corrective actions to obviate the threat of noncompliance with conditions in D-1641 that implement the 0.7 mmhos/cm EC water quality requirement by constructing the permanent gates or equivalent measures by July 1, 2009. The order also requires DWR and Reclamation to report to SWRCB if they exceed or threaten to exceed the water quality requirements and to report the reasons for the exceedance. SWRCB will then determine if enforcement actions are necessary. The cease and desist order also allows Joint Point of Diversion operation if DWR and Reclamation comply with the conditions of their water rights and SWRCB's order.

SWRCB was asked to reconsider its cease and desist order. However, the board did not take any action on this request, and the cease and desist order became a final order on May 16, 2006. On June 15, 2006, Reclamation and the State and federal water contractors filed a complaint in federal district court against SWRCB challenging the cease and desist order. DWR and SWRCB agreed to toll the date for DWR to file to allow time for the parties to negotiate a settlement of the issues. Reclamation and the water contractors have also entered into tolling agreements pending negotiations. Negotiations between the parties resulted in a letter from the SWRCB Executive Director that clarified the cease and desist order and extended DWR's time to file an action against the order to May 1, 2007.

In January 2007, SWRCB began workshops to review the southern Delta agricultural water quality objectives that are the subject of the cease and desist order and the litigation. This review is consistent with the Executive Director's letter to DWR regarding these objectives. The review is expected to require about 2 years to complete, after which SWRCB may consider modification of the objective in its Water Quality Control Plan and in DWR and Reclamation's water rights.

### **CALFED Litigation**

The CALFED record of decision (ROD) issued on August 28, 2000, was challenged by environmental groups and agricultural interests in both State and federal courts. The ROD established a number of program measures to help resolve conflicts over the use of water in the Delta. Initially, three complaints were filed in State courts: *Laub v. Davis, et al.* (California Farm Bureau Federation (Farm Bureau) and three individuals); *Regional Council of Rural Counties v. State, et al.* (Regional Council of Rural Counties (RCRC) and South and Central Delta); and *Municipal Water District of Orange County v. Resources Agency*. In 2004, the parties to the third suit settled,

based on an agreement that emphasizes the importance of the CALFED Science Program and provides notice to the Water District of Orange County about CALFED stakeholder participation opportunities. The other two cases were coordinated in the Sacramento County Superior Court.

The remaining parties claimed the CALFED programmatic environmental impact statement/environmental impact report (EIS/EIR) violated CEQA, the National Environmental Policy Act (NEPA), and the federal Administrative Procedure Act. The Superior Court found in favor of the plaintiffs. The State agencies appealed, and oral argument was held on August 30, 2005. The two cases were consolidated on appeal, and the Appellate Court reversed the lower court (*In Re Bay-Delta Programmatic Environmental Impact Report Coordinated Proceedings*, Court of Appeals, Third District, Consolidated Case Nos. C044267 and C044577).

The California Supreme Court agreed to hear the case. DWR argued that CEQA does not require a lead agency to analyze a suggested alternative to its proposed project if the proposal would fail to achieve the project's fundamental purpose. EIRs for general projects, like the broad CALFED 30-year plan, are a general analysis, whereas EIRs for detailed projects like subdivisions require a more in-depth analysis.

All briefing has been completed. The parties are waiting for the Supreme Court to set oral argument.

The issue of whether the federal agencies violated NEPA is pending in federal district court.

### **Hydropower**

#### ***Hyatt-Thermalito***

On April 29, 2005, 14 of the 29 State Water Contractors brought suit against DWR. These contractors claimed the method used by

DWR to allocate costs and revenue of its Hyatt and Thermalito Power Plants (Hyatt-Thermalito) at Lake Oroville violated the terms of long-term water supply contracts. (*Alameda County Flood Control & Water Conservation District, Zone 7 et al. v. State of California Department of Water Resources* (Sacramento County Superior Court, Case No. 05ASO1775).) In December 2005, entities representing 13 other contractors intervened in the lawsuit in opposition to the claims of the plaintiffs and in support of DWR's method of allocating costs and revenue. If the water contractors who filed the lawsuit are ultimately successful, this could result in contractors requiring the most pumping for delivery of their State Water Project water to pay more to DWR, while those contractors requiring less pumping would pay less.

The plaintiffs' motion to file an amended complaint adding causes of action for: (1) making the plaintiffs whole; (2) alleging defendants could not profit at the plaintiffs' expense; (3) breaching the agreement of good faith and fair dealing implicit with every contract; and (4) contending defendants received money which should have been paid to the plaintiffs, was granted on September 14, 2006. The plaintiffs have also expanded the list of desired remedies to include a court ordered trust, injunction, equitable lien, and attorney fees. In addition, the amended complaint joined two other State water contractors.

After a hearing on October 13, 2006, the court granted DWR's motion to bifurcate the case into two separate phases, i.e., liability and damages. The court has agreed to entertain motions for protective orders seeking to stay discovery on damages until conclusion of the liability phase. Pretrial discovery on the issues of contract interpretation and liability commenced in April 2007. Depositions of DWR employees were taken. On September 21, 2007, at a Case Management Conference, the first phase of the trial on contract interpretation was scheduled for May 12, 2008.

## Other Cases

Several cases pending resolution may affect SWP operations and costs. The first case involves a Federal Energy Regulatory Commission (FERC) ruling that the cost of certain Pacific Gas & Electric Company (PG&E) transmission facilities should be integrated into gridwide charges to California Independent System Operator (CAISO) customers, including DWR. DWR has appealed these charges on the basis that the facilities primarily benefit PG&E—not the grid as a whole—and the cost allocation mechanism should reflect this fact (*California Department of Water Resources v. Federal Energy Regulatory Commission* (U.S. Court of Appeals for the Ninth Circuit, No. 04-76131)). The Court of Appeals ruled against DWR, finding that if a facility serves any network function, its cost may be charged gridwide.

The *California Department of Water Resources v. Federal Energy Regulatory Commission* (U.S. Court of Appeals for the Ninth Circuit (No. 04-73577)) case involved a challenge to the manner in which the costs for the transfer of transmission facilities are allocated. FERC approved the transfer of the transmission facilities of Anaheim and Riverside to CAISO. As part of this transfer, costs for the facilities are spread to the users of the grid, including DWR. DWR is contesting the cost allocation mechanism in a current FERC proceeding. This appeal preserved the ability of DWR to contest costs in the administrative cost allocation proceeding. As a result of the decision in the PG&E transmission case (No. 04-76131), DWR dismissed this appeal.

The *California Department of Water Resources v. Federal Energy Regulatory Commission* (U.S. Court of Appeals for the Ninth Circuit (No. 05-74488)) case involved a challenge to the FERC decision concerning transmission access charge methodology. This charge is imposed on users of the CAISO grid to recover the embedded costs of

the grid. DWR has appealed these charges, primarily on the basis that FERC failed to use a time-of-use methodology. Briefs have been filed; however, oral argument has not been scheduled yet.

## Colorado River

Two lawsuits related to the Colorado River have potential implications for California water supply.

The first lawsuit is *Imperial Irrigation District v. All Interested Persons* and eight related cases (Judicial Council Coordination Proceeding No. 4353, Sacramento County Superior Court). This lawsuit is a series of nine claims, which have been coordinated into a single proceeding, before the Sacramento County Superior Court. These lawsuits challenge the Quantification Settlement Agreement (QSA) and associated actions taken to implement the QSA. The QSA is a collection of 38 agreements that resolve disputes among water users in Southern California regarding their rights to California's shrinking share of Colorado River water. The QSA facilitates California's plan to reduce its use by settling disputes regarding priority and use. For example: (1) transfer of conserved agricultural water from the Imperial Irrigation District to San Diego County Water Agency for urban uses; (2) establishing water budgets for the parties; and (3) providing for the mitigation of environmental impacts and the restoration of the Salton Sea. Proceedings in the Superior Court have been stayed, pending oral argument before the Third District Court of Appeal, on Imperial County's petition for writ of mandate.

On June 14, 2007, the Court of Appeal affirmed the lower court's dismissal of the litigation. A petition for rehearing filed by Imperial County was denied. In October, in accordance with the direction from the trial court, SWRCB sought dismissal of the air districts' writ of mandate under the same

indispensable party theory that dismissed Imperial County's action. Imperial Valley landowners filed a motion for preliminary injunction, seeking to enjoin the Imperial Irrigation District water transfer. The hearing is set for January 31, 2008.

*Consejo de Desarrollo Economico de Mexicali, A.C. et al. v. Norton, et al.* (U.S. District Court, District of Nevada, Las Vegas (No. CV-S-05-0870-KJD-PAL)) is a challenge to Reclamation lining the All American Canal. The All American Canal lining is a water conservation project that is an integral part of the QSA. The State, through DWR, is contributing \$220 million to the canal lining project. Mexican business leaders and California environmental groups filed a lawsuit that challenges the actions of the Secretary of the Interior and the Commissioner of the Bureau of Reclamation to authorize the All American Canal improvement project. This complaint seeks declaratory and injunctive relief. Claiming the conservation project will mean the loss of 100,000 af of recharge water per year, the plaintiffs assert a deprivation of water rights, including claims based on constitutional violations, Mexican federal law, and others. The plaintiffs also challenge the action based on violations of NEPA, the Administrative Procedure Act, the ESA, the Migratory Bird Treaty Act, and environmental mitigation obligations under the authorizing legislation (San Luis Rey Act (P.L. 100-675)) for the conservation project.

On February 9, 2006, the court dismissed all but one of the plaintiffs' causes of action, leaving only the claim challenging federal NEPA compliance. On February 23, 2006, plaintiffs filed a First Amended Complaint. The court's ruling on the defendants' subsequent summary judgment motion held that NEPA does not require a supplemental EIS on the canal lining project because the impacts in Mexico are beyond agency control and the impacts in the United States are too speculative. The case was appealed



to the Ninth Circuit, which on August 25, 2006, issued an injunction halting the project pending a December 6, 2006, court hearing.

While the matter was under advisement before the Ninth Circuit, new federal legislation was passed requiring the canal lining to proceed without further delay. The federal defendants filed a motion to dissolve the injunction and dismiss the appeal as moot as to half of the remaining claims.

The Ninth Circuit heard oral argument on the motion on February 21, 2007, and on April 6, 2007, the court vacated the injunction and remanded the case back to the federal district court for dismissal. The court ruled: (1) that the 2006 Administrative Procedure Act rendered the federal NEPA, ESA, Migratory Bird Treaty Act, and Settlement Act claims moot; (2) that the district court lacked jurisdiction over the takings claim, which should have been asserted before the Court of Federal Claims; and (3) that the remaining claims were barred by sovereign immunity. The Ninth Circuit, further, denied all pending motions as moot.

## Castaic Lake Water Agency

California Water Impact Network (CWIN) and the Friends of the Santa Clara River, both nonprofit environmental organizations, filed a Petition for Writ of Mandate against Castaic Lake Water Agency (Castaic Lake) in Ventura County. This Petition for Writ of Mandate challenged Castaic Lake's approval of a project to store up to 24,000 af of allocated 2002 Table A water, in the Semitropic Groundwater Storage Program, before the end of 2004. As reported in Bulletin 132-06, the CEQA process followed by DWR and Castaic Lake was upheld by the 2nd District Court of Appeal and the time for appeal to the California Supreme Court has run out. The plaintiffs alleged the approval of the project violated CEQA, the Urban Water Management Planning Act, and the Public

Trust Doctrine. The plaintiffs alleged that DWR should have been the lead agency in the preparation of an EIR. The Friends of the Santa Clara River had also filed a Reverse Validation Action in Sacramento County, which sought to set aside the agreement. Following the resolution of the CEQA case in Ventura County, plaintiffs filed a motion to dismiss the Sacramento case.

CWIN and the Planning and Conservation League (PCL) also challenged a new EIR certified by Castaic Lake for the permanent transfer of 41,000 af of SWP Table A water to Castaic Lake from Kern County Water Agency (Kern) member unit, Wheeler Ridge-Maricopa Water District. These lawsuits were filed on January 24 and January 26, 2005. The original EIR, which was certified by Castaic Lake for this transaction, was successfully challenged in *Friends of the Santa Clara River v. Castaic Lake* on the grounds that it tiered off the decertified Monterey Agreement EIR. In response to the Los Angeles Superior Court's Order on remand in that case, Castaic Lake decertified its original EIR on December 27, 2002, and issued a Notice of Preparation for a new EIR on January 22, 2003. The new EIR, which does not tier off any EIR for the Monterey Agreement, was certified on December 23, 2004. DWR entered into contract amendments with both Castaic Lake and Kern, which implemented this transfer in 1999. DWR has been basing its SWP allocations to Castaic Lake on the increased Table A amount.

DWR is primarily concerned with the CWIN and PCL arguments that: (1) DWR, and not Castaic Lake, should be the lead agency under CEQA for this transaction and (2) the EIR should tier off of the not-yet-complete Monterey Plus EIR. Other issues raised by CWIN and PCL are that the EIR is inadequate under CEQA for a number of reasons, including violation of the Urban Water Management Planning Act and the Public Trust Doctrine, and it represents a prejudicial abuse of discretion.

The two cases were consolidated and a hearing on the merits was held on March 19, 2007. On May 22, 2007, the judge ruled in favor of Castaic Lake and the respondents in all but one aspect. He found that Castaic Lake could be the lead agency and did not have to wait for DWR to complete the Monterey Plus EIR to proceed. However, the judgment found that the 2004 EIR had one defect. It failed to show the analytic route as to how and why various allocations of SWP water are relevant and would occur. He required Castaic Lake to set aside its approval of the EIR and to comply with CEQA either through a new EIR or other environmental documentation, including an addendum. Plaintiffs have filed an appeal from the trial court decision. Castaic Lake has filed a cross-appeal. The parties have agreed to suspend actions on attorney fees until after a Court of Appeal decision.

## Environmental Review Acts

The National Environmental Policy Act (NEPA) (Title 42 United States Code Sections 4321–4347 [1970]) and the California Environmental Quality Act (CEQA) (California Public Resources Code Sections 21000–21177 [1970]) require government agencies to document and consider environmental consequences of their actions in their decision-making processes. NEPA states that it is the goal of the federal government to use all practicable means consistent with other considerations of national policy to protect and enhance the quality of the environment. All federal agencies must prepare an environmental impact statement (EIS), including a discussion of mitigation measures and alternatives, for federal actions that could significantly affect environmental quality.

CEQA is patterned after NEPA. Under CEQA, agencies are required to (1) disclose, through an environmental impact report (EIR), the significant impacts a proposed project would have on the environment, and (2) identify ways to reduce or avoid environmental damage.

CEQA applies to projects directly undertaken, funded, or approved by State or local agencies. NEPA applies to projects directly undertaken, funded, or approved by federal agencies. The Department of Water Resources conducts many projects in cooperation with federal agencies. In these cases, both CEQA and NEPA must be followed.

NEPA requires that mitigation measures and alternatives be disclosed to the public in the EIS, but it does not generally require federal agencies to adopt such mitigation measures or alternatives. CEQA does impose substantive duties on all California government agencies approving projects with significant environmental impacts to adopt alternatives or mitigation measures that they find to be feasible to substantially lessen these impacts, unless there are overriding reasons they cannot. When a project is subject to both CEQA and NEPA, both laws encourage agencies to cooperate in planning the project and preparing joint environmental documents.

The environmental review process allows citizens to learn about a proposed project and its potential significant effects and to participate in the decision-making process by providing feedback on agency information. The review process requires agencies to:

- describe the proposed project and the purpose or need for it;
- identify the lead and cooperating agencies involved in the project;
- invite interested parties to participate in the process;
- determine the scope of study with input from responsible agencies and the public;
- prepare and distribute a draft EIS or EIR;
- respond to comments received on the draft;
- prepare the final EIS or EIR;
- make findings and adopt feasible alternatives or mitigation measures to avoid significant effects, if applicable;

### **Environmental Review Acts (*continued*)**

- adopt a monitoring plan to ensure compliance with mitigation measures; and
- prepare a list of permits required to implement the project if it is approved.

The scoping phase, which occurs early in the review process, is particularly important because it enables government agencies to identify issues and topics to be considered or addressed in the EIS or EIR.

Information gathered in the scoping phase helps agencies identify and evaluate reasonable alternatives, identify potential environmental impacts of the project, determine data and information needed, develop a work schedule, and allocate resources for preparing and distributing the draft environmental document for public review and comment.

NEPA requires a lead agency to involve the public during scoping, while CEQA does not. CEQA, however, does encourage public involvement at this stage. Members of the public may raise issues and identify additional alternatives, environmental effects, methods of assessment, and mitigation measures during the scoping phase and continue to participate in the review process for the draft environmental document. Thus, the CEQA process may lead to changes in a project through the development, consideration, and adoption of alternatives or enforceable mitigation measures to avoid or reduce any potential significant adverse effects on the environment.

If the project is approved, the lead agency publishes a document discussing all the factors considered in reaching its decision to proceed with the proposed action. It also discusses whether all practical means to avoid or minimize environmental harm have been adopted, and if not, the reasons they were not.



## **Chapter 7**

# **Water Supply Development and Reliability**

*The Delta Cross Channel near the town of Locke on the Sacramento River.*

## Significant Events in 2007

The Department of Water Resources (DWR), in cooperation with federal and State agencies, completed a pilot salmon outmigration study in the North Delta. DWR also conducted value engineering studies for the Franks Tract Project and the Through-Delta Facility Project.

The Governor issued a list of immediate and interim actions, including the Franks Tract Project, to be included as part of a comprehensive water package to improve Delta conditions.

The draft environmental impact report/environmental impact statement (EIR/EIS) for the Proposed Lower Yuba River Accord was released to the public on June 26, 2007, for a 60-day public review and comment period. The final EIR/EIS for the proposed accord was released to the public on October 23, 2007.

The draft supplemental EIS/EIR to the Environmental Water Account (EWA) final EIS/EIR became available on October 26, 2007.

DWR prepared an addendum on October 29, 2007, to the previously certified EWA EIS/EIR for the purpose of continuing actions described in the EIS/EIR for an additional year, to December 31, 2008.

*Information in this chapter was contributed by the State Water Project Analysis Office, the Division of Integrated Regional Water Management, the Division of Statewide Integrated Water Management, and the Bay-Delta Office.*

The Department of Water Resources (DWR) is working to improve the reliability of State Water Project (SWP) supplies and the long-term water contract annual Table A water allocations delivered to SWP water contractors. Staff is engaged in planning activities to develop additional water supplies and storage capacity.

Developing new water supplies and storage projects that are economically, environmentally, and technically sound, while satisfying institutional requirements and political concerns, presents significant challenges. Many concerns center on possible adverse effects that additional storage and delivery facilities may have locally and on the Sacramento-San Joaquin Delta. In the SWP conveyance system, the Delta is the critical link between water supplies in the Sacramento Valley and deliveries to the rest of the Central Valley and Southern California.

DWR works with the State and federal governments, local agencies, and public interest stakeholder groups to ensure water supply reliability now and in the future. To meet SWP water contractors' needs for sufficient water supplies, DWR is engaged in planning, developing, and providing local assistance with the objective of augmenting future SWP water supplies.

## Supply Development and Reliability

Some of the activities DWR is engaged in to augment future SWP supplies include:

- implementing programs to transfer water, such as the Dry Year Water Purchase Program, the Environmental Water Account (EWA), and facilitating transfers between SWP long-term contractors and other agencies, including Central Valley Project (CVP) contractors;
- assisting in the development and implementation of local and regional conjunctive use programs in the Sacramento Valley;
- constructing a groundwater monitoring network and a subsidence monitoring network to detect potential impacts caused by pumping associated with groundwater substitution transfers;
- managing the Feather River watershed above Lake Oroville to reduce sedimentation in the lake and preserve storage capacity; and
- investigating and evaluating storage projects.

## Water Conveyance Through the SWP

DWR encourages and facilitates temporary transfers of water using SWP conveyance facilities for long-term SWP water contractors and other agencies to help meet local, State, and environmental water supply needs. As a practical matter, SWP facilities are often needed to convey transfer water from the existing place of use to the place of use of the transferee. State law requires DWR to make unused SWP capacity available for transfers upon payment of fair compensation, provided that (1) no legal user of water will be injured; (2) there will be no unreasonable effect on fish, wildlife, or other instream beneficial uses; and (3) there will be no unreasonable effect on the overall economy or the environment of the county from which the water is being transferred (California Water Code [CWC] Section 1810). Water transfers can involve transfers and

exchanges among SWP long-term water contractors, between SWP water contractors and non-SWP entities, or between two or more non-SWP entities.

The transferability of water depends on many factors including the source of the water being transferred, what is being done to make water available, when the water can be made available, and the type of water right the existing user holds. Several CWC provisions authorize temporary transfers and put conditions on those transfers to protect those not involved in them. Short-term transfers, of less than one year, are authorized under Sections 1725–1732. Long-term transfers, for periods greater than one year, are authorized by Sections 1735–1737. Other CWC sections specify conditions under which water can be transferred and legal protections for those transferring water. For information regarding specific transfers or exchanges, please see Chapter 9, Water Contracts and Deliveries.

### ***Transfer and Exchange Evaluations***

An important element of any water transfer is determining what quantity of water, if any, is transferable. Several CWC provisions (e.g., Sections 1702, 1706, 1725, and 1736), are intended to protect other legal users of water and fish and wildlife from the possible adverse effects of a water transfer. These provisions reflect the concept that changes can be made to water supply as long as there is no injury to others as a result of the change (the “no injury rule”). The no injury rule in State water law is intended to protect other water right holders from a water user’s expansion of water use beyond what has been used historically under that water user’s existing water rights. Hence, under the no injury rule, only “new water” is transferable (i.e., water that adds to the downstream water supply as a result of the transfer). To protect other users, a transfer would not be authorized to the extent that it would reduce the amount or timing of

water that would have been available to downstream users, regardless of the water priority of those users.

CWC Section 1810(d) requires DWR to consider potential impacts of a transfer to legal users, to instream uses, and to the economy of the area from which the water would be transferred. DWR must also determine whether to allow use of its surplus water conveyance capacity for a transfer. DWR reviews each request to transfer water through SWP facilities to assure that only new water will be transferred.

Transfer water is typically developed through four methods: surplus water released from storage facilities, substitution of groundwater for transferred surface water, idling agricultural land, and undertaking conservation activities that develop new water. Transfers may result in direct impacts and third party impacts (on parties not involved in the transfer). Certain CWC provisions were enacted to limit potential impacts. For example, additional groundwater pumping from a groundwater substitution program can potentially affect other groundwater users in the area. CWC Section 1745.10 generally requires that transfers of surface water where groundwater will be pumped to make up for the transferred surface water: (1) be consistent with a groundwater management plan adopted pursuant to State law for the affected area or (2) do not create or contribute to conditions of long-term overdraft in the affected groundwater basin.

Injury can also occur due to stream depletion induced by pumping wells near a stream. The amount of water depleted from the stream as a result of the increased pumping must be deducted from the amount of water transferred or the groundwater pumping is not truly an addition to the surface water supply, and the net surface water flows will not increase as assumed. Consequently, to



evaluate possible impacts from groundwater substitution transfers, DWR requires that users proposing to transfer water through groundwater substitution provide the information required to estimate the effects on the surface water system. Each type of transfer has its own set of potential impacts that must be evaluated to protect parties not involved in the transfer.

With the exception of short-term transfers done under CWC Section 1725, which go through the State Water Resources Control Board (SWRCB), water transfers are subject to compliance with the California Environmental Quality Act (CEQA), and, possibly, the National Environmental Policy Act (NEPA). The CEQA/NEPA and SWRCB processes provide opportunities for public review and comment on water transfer proposals.

Staff in the State Water Project Analysis Office, Division of Operations and Maintenance, Division of Integrated Regional Water Management, and the Office of the Chief Counsel evaluate proposed water transfers to determine whether they will impact the SWP, other water users, the environment, or the area from which the water will be transferred.

## SWP Delivery Reliability Report

To assist local agencies assessing their overall water supplies, DWR prepares a biennial draft and final report entitled *The State Water Project Delivery Reliability Report*. For the 2007 draft report, DWR provided current data on the SWP's ability to deliver water under 2007 conditions and for projected conditions. The 2007 final report will be issued in 2008, and the next draft update of this biennial report is expected in 2009.

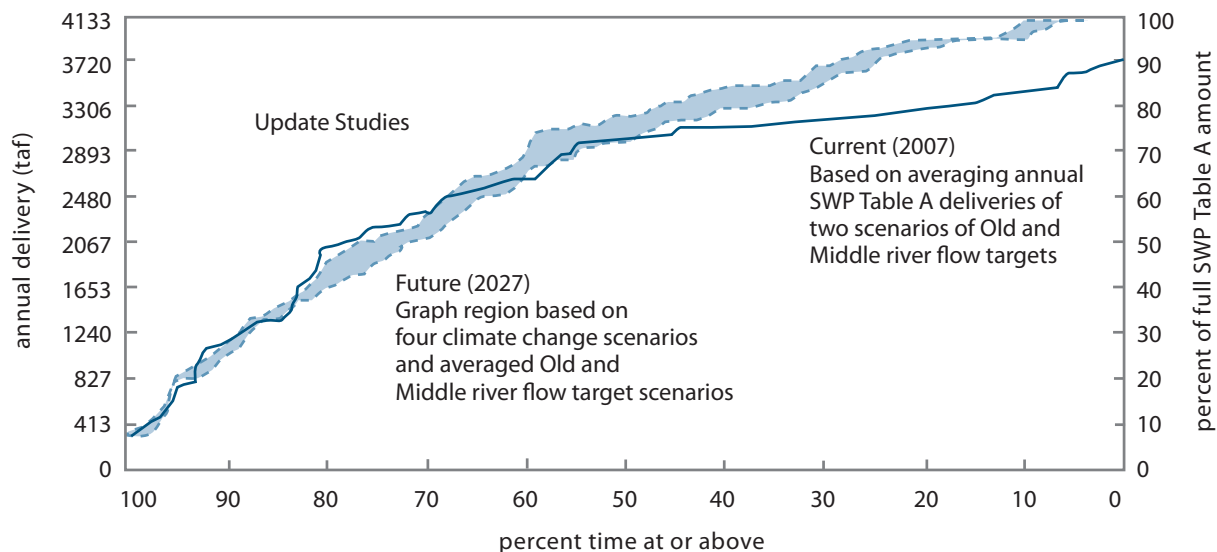
Water delivery reliability depends on three factors: the availability of water at the source, the ability to convey water from

the source to the desired point of delivery, and the level of demand. Information in *The State Water Project Delivery Reliability Report 2007–Draft* for projected conditions is based on four climate change scenarios. In addition, the analysis of the ability to convey water from the source to the point of delivery assumes only SWP facilities and permits existing in 2007. To provide a conservative estimate of water delivery reliability, no planned facility improvements to the SWP are assumed. Lastly, the level of demand, amount, and pattern of demand for SWP water were derived from historical data and information received from SWP water contractors.

The probability that a given level of SWP annual Table A water will be delivered from the Delta for conditions both in 2007 and projected to exist in 2027 is shown on Figure 7-1. The following can be deduced for year 2027 conditions:

- In 75 percent of the years, annual SWP Table A water delivery is estimated to be at or above the range of 1.86 to 2.08 million acre-feet (maf) per year (45 to 50 percent of 4.13 maf).
- In 50 percent of the years, delivery is estimated to be at or above the range of 2.97 to 3.21 maf per year (72 to 78 percent of 4.13 maf).
- In 25 percent of the years, delivery is estimated to be at or above the range of 3.69 to 3.82 maf per year (89 to 92 percent of 4.13 maf).

Detailed information on the assumptions, data, and results of additional studies, as well as other scenarios for annual Table A amounts, can be found in the reliability report at [http://www.water.ca.gov/pubs/swp/swp\\_delivery\\_reliability\\_report\\_2007/swpdrr07.pdf](http://www.water.ca.gov/pubs/swp/swp_delivery_reliability_report_2007/swpdrr07.pdf).



**Figure 7-1 SWP Table A Water Delivery Probability for Years 2007 and 2027**

## SWP Future Water Supply Program

The Future Water Supply (FWS) Program is managed to coordinate DWR’s efforts to ensure the success of the Sacramento Valley Water Management Program (SVWMP). The FWS Program also provides technical support within DWR for the Lower Yuba River Accord (Yuba Accord) and the EWA by monitoring and assessing the conditions of the Sacramento Valley groundwater basin and the effects the Yuba Accord and the EWA have upon the basin. These activities emphasize coordination with local agencies, which have become increasingly active in developing groundwater management programs and asserting control over water supply development and management. To develop water management alternatives that benefit all water rights holders in the Sacramento Valley, DWR provides technical assistance to local agencies through the FWS Program and technical and financial assistance through the Conjunctive Water Management Program. DWR’s goal for these

efforts is to build consensus for local and regional conjunctive use.

The FWS Program’s Upper Feather River watershed management component evaluates the state of the Feather River watershed above Lake Oroville and identifies actions that can be taken within the watershed to increase base-flow runoff and reduce sedimentation. The initial effort explored ways to improve local water supplies without adversely affecting SWP supply or operations. Activities included installing monitoring equipment and gathering pertinent data on stream flows, water quality, erosion, and land use. The data were used to formulate reports and studies for future action. The work received strong local support.

## Sacramento Valley Water Management Program

DWR, the Bureau of Reclamation (Reclamation), water users in the Sacramento River Basin (upstream water

users), and water contractors of the SWP and CVP (downstream water users) have been working to implement the SVWMP since the Short-Term Settlement Agreement (*Short-Term Agreement to Guide Implementation of Short-Term Water Management Actions to Meet Local Water Supply Needs and to Make Water Available to the SWP and CVP to Assist in Meeting the Requirements of the 1995 Water Quality Control Plan and to Resolve Phase 8 Issues*) became effective in February 2003. For more information on the development and implementation of the SVWMP, and issues surrounding the Short-Term Settlement Agreement, see Bulletins 132-02, 132-03, and 132-04, available at <http://www.water.ca.gov/swpao/bulletin.cfm>.

During 2007, the Sacramento Valley Water Management Agreement (SVWMA) Management Committee, consisting of representatives from DWR, Reclamation, upstream water users, and downstream water users, renewed their commitment to implement the SVWMP. DWR continued to participate in developing the SVWMP EIS/EIR in collaboration with Reclamation and their consultant. However, progress on the environmental document was hindered by concerns that assumptions were not sufficiently defined to conduct baseline (pre-project) conditions computer modeling of SWP and CVP operations for the environmental analysis. Many simultaneously occurring factors regarding the Delta contributed to this uncertainty. These included:

- pelagic organism decline (POD) in the Delta;
- Operations Criteria and Plan (OCAP) litigation;
- OCAP Endangered Species Act (ESA) reconsultation;
- Bay-Delta Conservation Plan (BDCCP) development; and
- Delta Vision recommendations.

DWR continued to implement the SVWMP monitoring plan. Activities included constructing monitoring wells for Yuba County Water Agency (Yuba), Glenn County, and other local agencies that had received grant awards from DWR for this purpose. The wells in Yuba County monitor the conjunctive use activities of the Yuba Accord. The wells in Glenn County will help determine how implementing the SVWMP affects local hydrologic conditions. DWR continued to collect, maintain, and analyze groundwater level data throughout the Sacramento Valley to establish a basis of comparison for the projects that are proposed to operate as part of the SVWMP, the EWA, and the Yuba Accord.

## SWP Water Rights Activities

### Water Rights Permits

SWP operations are governed by the terms and conditions contained in DWR's water rights permits and licenses along with other State and federal regulatory restrictions, such as biological opinions (BO) for the protection of endangered species. DWR currently holds 15 water right permits for the operation of the SWP and upper Feather River facilities, five of which specifically authorize SWP operations at the Oroville/ Thermalito and Delta facilities, including the North Bay Aqueduct, for water supply purposes. Each permit specifies the authorized quantities of direct diversion and diversion to storage, place of use, and time within which the permitted quantities must be put to beneficial use. A change in any of the terms and conditions contained in the water right permits and licenses requires SWRCB approval.

Diversion and use of SWP water throughout the SWP service area has steadily increased since initial operations in the 1960s. However, due to a number of factors, including operational and regulatory constraints, the beneficial use of water has

not yet reached the maximum quantities anticipated for full development of the SWP. When the full permitted quantity of water authorized under the water right permits has not been utilized by the date specified in the permit, a petition for time extension must be submitted to the SWRCB.

### Water Quality Control Plan for the San Francisco Bay/Sacramento-San Joaquin Delta Estuary

The Delta and Suisun Marsh are located where California's two major river systems, the Sacramento and San Joaquin, converge to flow westward to meet incoming seawater tides flowing through the San Francisco Bay. The watershed of the San Francisco Bay/Sacramento-San Joaquin Delta Estuary (Bay-Delta Estuary) is a critical source of water supply for much of California. The watershed is a source of drinking water for two-thirds of the State's population; it supplies some of the State's most productive agricultural areas; and it provides water for fish, wildlife, and other public trust uses of water within and upstream of the estuary.

Water originating in the Bay-Delta watershed is delivered to areas within the watershed and to areas south and west of the estuary. The primary water distribution systems that release stored water into the Delta and directly divert water from the Delta are the SWP, operated by DWR, and the federal CVP, operated by Reclamation. Numerous other water storage and diversion projects affect the inflows and outflows of the Bay-Delta Estuary.

SWRCB regulates both the quality of water in the Bay-Delta Estuary and the diversion and use of water released into and diverted from the Bay-Delta Estuary for water supply. SWRCB coordinates its regulatory authorities under State laws governing water quality and water rights to ensure that water quality is protected for all beneficial uses when water is diverted from the estuary. The *Water*

*Quality Control Plan for the San Francisco Bay/Sacramento-San Joaquin Delta Estuary* (Bay-Delta Plan) establishes water quality objectives for flow, salinity, dissolved oxygen levels, and other parameters for the protection of beneficial uses such as municipal and industrial, agricultural, and fish and wildlife. SWRCB reviews volumes of testimony and evidence to establish water quality objectives for these uses, then implements the objectives in part or in whole, depending on the circumstances, through conditions on water right permits and licenses.

DWR has worked cooperatively with SWRCB for more than 50 years to support development of appropriate water quality standards for the Bay-Delta Estuary and to identify which water sources are required to meet those standards. The current objectives are contained in the 2006 Bay-Delta Plan, adopted December 13, 2006. In 1999, SWRCB adopted Water Right Decision 1641 (D-1641) (later modified by Order WR 2000-02) to implement the objectives in the 1995 Bay-Delta Plan. SWP licenses and permits were amended to include the terms and conditions outlined in D-1641.

SWRCB may initiate water right proceedings to allocate responsibility to meet established objectives among water right holders who divert water from the watersheds of the Bay-Delta Estuary. They may also establish terms and conditions on the use of affected water rights. SWRCB prepares appropriate documentation under CEQA, in addition to documentation included with the 2006 Bay-Delta Plan.

For more information about the SWRCB, see Chapter 4, Water Quality Programs.

### SWRCB Bay-Delta Proceedings—2007 Activities

In 2007, SWRCB proceedings examined a number of issues in the Bay-Delta Estuary

relating to water quality, salinity, fishery protection, and pelagic organism decline, which have the potential to affect Delta water supply and reliability.

### **South Delta Salinity**

On January 16, 2007, SWRCB convened a workshop to receive information and conduct detailed discussions on the south Delta agricultural salinity objectives. SWRCB specified that the information provided focus on salinity objectives and a corresponding program of implementation. SWRCB also requested that participants recommend studies they believe are needed regarding salinity in the southern Delta. Based on the information in these recommendations, SWRCB would evaluate whether additional studies and other efforts could support an amendment to the Bay-Delta Plan.

To improve water circulation, levels, and quality for agricultural uses, South Delta Water Agency (SDWA) has been relying on a proposed physical solution of permanent operable gates to be installed in the southern Delta. Although these permanent gates may continue to be the preferred solution for implementing southern Delta agricultural objectives, information provided to SWRCB during the D-1641 water rights hearings showed that these gates will not effectively control salinity under dry year conditions and will not have a significant effect on water quality at some of the compliance locations. Therefore, it was recommended that SWRCB consider including in the 2006 Bay-Delta Plan and its program of implementation additional methods other than the permanent operable gates to achieve these objectives.

On April 24, 2007, DWR, in coordination with Reclamation and in compliance with Condition 4 of SWRCB Order WR 2006-0006, submitted a "Report of Potential Exceedence of South Delta Water Quality Agricultural Objective" to SWRCB. Condition 4 discusses

potential exceedence of the agricultural water quality objective at three compliance monitoring stations in the South Delta. Since actions causing exceedence were beyond the reasonable control of DWR and Reclamation, the letter did not offer any corrective actions at that time.

Later in the year, in response to DWR's letter regarding potential exceedence of the South Delta agricultural objectives, SWRCB requested a feasibility study of increased San Joaquin River flows. This feasibility study would include water releases from New Melones Reservoir, water recirculation through the Delta Mendota Canal, and other water releases in the San Joaquin basin. SWRCB indicated that there was substantial evidence that salinity issues within the South Delta were due to Reclamation operations and therefore recommended that Reclamation participate in identifying and developing potential solutions.

On May 4, 2007, DWR participated in an SWRCB meeting regarding Southern Delta salinity objectives and discussed DWR modeling capabilities, time frames for studies, and more specific definitions of operations.

For a more thorough discussion of salinity issues and objectives in the South Delta, see Chapter 4, Water Quality Programs.

### **Fishery Protection Plan**

On February 8, 2007, SWRCB approved the Revised Fishery Protection Plan (Fishery Plan) for Joint Point of Diversion (JPOD), dated December 26, 2006. The Fishery Plan is required by SWRCB D-1641 and must be approved by SWRCB prior to the commencement of Stage 2 JPOD operations. The Fishery Plan was approved subject to conditions that included compliance with updated BOs. A JPOD would afford increased opportunities for the CVP to fill San Luis Reservoir (a joint storage facility) when there

are high winter flows through the Delta. There are times when the pumping rate at Banks Pumping Plant is significantly less than the maximum allowable rate. The JPOD provisions would allow unused capacity at Banks Pumping Plant to be made available to Reclamation for filling the CVP share of San Luis Reservoir early. A shift towards increased Delta pumping capability earlier in winter, such as might be provided for by a JPOD, could result in additional decreases in project pumping during the early spring, if both SWP and CVP shares of San Luis Reservoir are full, since typical demands during this time are relatively low.

### **Pelagic Organism Decline**

On March 22, 2007, SWRCB convened a workshop to consider POD in the Bay-Delta Estuary. The workshop covered current studies and available results; proposed studies and projected time lines for implementation; status of the scientific peer review of the work plan prepared by the POD team; and interim actions SWRCB needs to consider, based on available information. During the workshop, DWR presented related documents, including the 2007 *Pelagic Fish Action Plan*, *Interagency Ecological Program 2006–2007 Work Plan to Evaluate the Decline of Pelagic Species in the Upper San Francisco Estuary*, and response to the CALFED Science Program Review Panel Report to the IEP Management Team on POD. The pelagic fish action plan was prepared in coordination with the Department of Fish and Game (DFG).

For more information on POD, see Chapter 3, Environmental Programs.

## **CALFED Bay-Delta Program**

The California Bay-Delta Authority (CBDA) oversees the implementation of the CALFED Bay-Delta Program for the 25 State and federal agencies working cooperatively to improve the quality and reliability of

California's water supplies, while restoring the Bay-Delta ecosystem.

The California Bay-Delta Act of 2003 established the CBDA as the governance structure and charged it with providing accountability, ensuring balanced implementation, tracking and assessing the CALFED Bay-Delta Program progress, using sound science, assuring public involvement and outreach, and coordinating and integrating related government programs.

The CALFED Bay-Delta Program mission is to develop and implement a long-term comprehensive plan to restore ecological health and improve water management for beneficial uses of the Bay-Delta. DWR supports this effort to develop and manage the State's water resources to meet SWP water delivery commitments and to benefit both the public and the environment.

The CALFED Bay-Delta Program is envisioned as a 30-year plan and is implemented through 11 major program elements. The first 7-year phase of implementation, Stage 1, includes planning for proposed large facilities and implementation of lesser facilities. DWR is the State lead agency for the storage program element, which consists of surface storage studies and groundwater programs and projects.

### **Storage Program**

The storage program is a comprehensive program with potential benefit for the SWP consisting of actions related to surface and groundwater storage. The Division of Statewide Integrated Water Management and the Division of Integrated Regional Water Management have been working with CALFED agencies to enhance storage and conjunctive-use programs that support local project development via loans and grants. The storage program is part of an ongoing evaluation of how storage, both groundwater

## CALFED Bay-Delta Program

The San Francisco Bay/Sacramento-San Joaquin Delta (Bay-Delta) Estuary is the largest estuary on the West Coast. It is a maze of tributaries, sloughs, and islands, and a haven for more than 750 plant and wildlife species. It is also the hub of California's two largest water distribution systems—the Central Valley Project, operated by the U.S. Bureau of Reclamation, and the State Water Project, operated by the Department of Water Resources. Together, these water development projects divert approximately 20 to 70 percent of the natural flow in the system, depending on the amount of runoff available in a given year. This, along with other issues, such as population growth and pollution, have had a serious impact on water supply and quality and on the fish and wildlife resources in the estuary. Although there is consensus that the Bay-Delta Estuary is important as both a reliable source of water and as fish and wildlife habitat, there was none for resolving conflicts regarding methods of management, conservation, increasing system capacity, and protecting the region's ecology.

In June 1994, in the quest for solutions to the resource problems in the Bay-Delta, State and federal agencies signed an agreement to: (1) coordinate their actions to meet water quality standards to protect the Bay-Delta Estuary; (2) coordinate the operation of the State Water Project and the Central Valley Project more closely with recent environmental mandates; and (3) develop a process to establish a long-term Bay-Delta solution to address four categories of problems—ecosystem quality, water quality, water supply reliability, and levee system vulnerability. This agreement, *Principles for Agreement on Bay-Delta Standards between the State of California and the Federal Government* (Bay-Delta Accord) signed in December 1994 by the State and federal governments, detailed interim measures for both environmental protection and regulatory stability.

The Bay-Delta Accord laid the foundation for the CALFED Bay-Delta Program, which began in May 1995. The *CALFED Bay-Delta Program, Final Programmatic Environmental Impact Statement/Environmental Impact Report* was released in July 2000, followed by the *Programmatic Record of Decision* in August 2000.

The California Bay-Delta Act of 2003 established the California Bay-Delta Authority as the new governance structure and charged it with providing accountability, ensuring balanced implementation, tracking and assessing the CALFED Bay-Delta Program progress, using sound science, assuring public involvement and outreach, and coordinating and integrating related government programs.

The CALFED Bay-Delta Program is designed to address the complex issues that surround the Bay-Delta and is a cooperative interagency effort involving 25 State and federal agencies with management or regulatory responsibilities for the Bay-Delta. It is an unprecedented effort to build a framework for managing California's most precious natural resource—water. Establishment of the CALFED Bay-Delta Program represents State and federal government in partnership, launching the largest, most comprehensive water management program in the world.

conjunctive use and surface storage, can meet California's urban, agricultural, and environmental supply reliability and water quality needs.

### **Surface Storage Investigations**

Surface storage investigations are developing environmental documentation and feasibility studies for four of the five surface storage projects identified for further study in the CALFED Record of Decision (ROD).

State and federal scientists have detected a decline in the Delta's pelagic organisms. Consequently, Delta export pumping increases anticipated by the South Delta Improvements Program (SDIP) were not achieved, causing a reassessment of modeling studies, scope, and schedule for the surface storage projects.

**In-Delta Storage Program.** The In-Delta Storage Program would provide capacity to store approximately 217,000 af of water in the South Delta for a wide array of water supply, water quality, and ecosystem benefits. The project would include two storage islands (Webb Tract and Bacon Island) and two habitat islands (Holland Tract and Bouldin Island).

No work was done on this project in 2007, and further detailed study of the In-Delta Storage Program is suspended until a proposal is submitted by potential participants detailing their specific interests, needs, and objectives that would support reinitiation.

For more information about this project, see Chapter 7, Water Supply Development and Reliability, Bulletin 132-07, at <http://www.water.ca.gov/swpao/bulletin.cfm>.

**Los Vaqueros Reservoir Expansion Project.** Contra Costa Water District (Contra Costa) owns and operates the 100,000 af Los Vaqueros Reservoir just southwest of the

Sacramento-San Joaquin Delta. The Los Vaqueros Reservoir Expansion Project involves analysis of increasing reservoir storage by as much as 400,000 af, for a potential storage capacity up to 500,000 af.

The project objectives are to (1) improve Bay Area water supply reliability, (2) provide an environmental water supply to the long-term EWA or similar program, and (3) improve water quality for Bay Area water users.

Contra Costa ratepayers voted to support further studies of the Los Vaqueros Reservoir Expansion Project in a March 2004 advisory vote. In 2006, Reclamation, in coordination with DWR and Contra Costa, completed a report entitled *Initial Economic Evaluation for Plan Formulation*. Also in 2006, Contra Costa filed a Notice of Preparation under CEQA to prepare an EIR. Contra Costa is the lead agency under CEQA and, in coordination with Reclamation and DWR, will continue with the feasibility study and environmental documentation.

### **Shasta Lake Enlargement Investigation.**

Reclamation, in coordination with DWR and other agencies, is conducting a feasibility study of expanding Shasta Dam and Reservoir, primarily to promote increased survival of anadromous fish populations in the upper Sacramento River and to increase water supply reliability. An enlargement of Shasta Dam would inundate additional lands around the existing reservoir and affect a portion of the McCloud River. California Public Resources Code Section 5093.542(c), the Wild and Scenic Rivers Act, states that, "except for participation by the DWR in studies involving the technical and economic feasibility of enlargement of Shasta Dam, no department or agency of the state shall assist or cooperate with, whether by loan, grant, license, or otherwise, any agency of the federal, state, or local government in the planning or construction of any dam, reservoir, diversion, or impoundment facility that could have an adverse effect on the



free-flowing condition of the McCloud River, or on its wild trout fishery.”

The State budget does not include funding for DWR to continue participating in this study. However, in 2007, Reclamation continued work on the feasibility study and an EIS and completed the Plan Formulation Report for federal review.

**North-of-the-Delta Offstream Storage Investigation.** DWR and Reclamation are working in partnership with local, State, and federal agencies to further study north-of-the-Delta offstream storage opportunities. The North-of-the-Delta Offstream Storage (NODOS) Investigation focuses on potential projects on the west side of the Sacramento Valley, including Sites Reservoir.

Storing water in offstream reservoirs during excess flow periods could provide opportunities to increase water storage in an environmentally sensitive manner. The stored water could then be made available to enhance water management flexibility in the Sacramento Valley and the Bay-Delta Estuary, reducing water diversions on the Sacramento River during critical fish migration periods, increasing the reliability of supplies for the Sacramento Valley and statewide, and providing storage and operational flexibility to augment environmental water supplies and adapt to climate change.

In 2007, DWR and Reclamation continued with the feasibility study and NEPA/CEQA process for the NODOS Investigation. In April 2007, DWR and Reclamation completed a supporting document entitled *A Conceptual Framework for Modeling of Physical River Processes and Riparian Habitat on the Sacramento River, California*.

**Upper San Joaquin River Basin Storage Investigation.** DWR and Reclamation, in coordination with other State and federal agencies, are evaluating opportunities for

increased storage in the upper San Joaquin River watershed. Storage could be added by expanding Millerton Lake by raising Friant Dam or by a functionally equivalent storage program. Potential objectives of the Upper San Joaquin River Basin Storage Investigation (USJRBSI) include (1) contributing to the restoration of the San Joaquin River, (2) improving the water quality of the San Joaquin River, and (3) facilitating additional conjunctive management and water exchanges that improve the quality of water deliveries for urban communities. Other benefits could include hydropower, flood control, and recreation.

In 2006, the parties to the San Joaquin River litigation reached agreement, significantly affecting the USJRBSI baseline assumptions. Following the settlement agreement, DWR and Reclamation developed an interim plan to revise the study assumptions, objectives, scope, and schedule. The revised objectives are to increase water supply reliability for agricultural and urban users and enhance San Joaquin River water temperature and flow conditions. Another key change to the investigation was the inclusion of water releases from Friant Dam dedicated to restoring fish populations in the San Joaquin River (as agreed to in the settlement) in the without-project conditions. DWR and Reclamation continued with the feasibility study and the NEPA/CEQA process for the reformulated USJRBSI.

In 2007, DWR and Reclamation completed geologic drilling investigations at potential dam and borrow sites and conducted habitat mapping and surveys of sensitive species. The U.S. Fish and Wildlife Service (USFWS) prepared a baseline habitat evaluation for the reservoir areas. A 2007 Study Update brochure was released by DWR and Reclamation summarizing these activities.

## Conveyance Program

The Conveyance Program consists of projects proposed in the North and South Delta. These projects are discussed briefly below, but for more information about the North and South Delta, see Chapter 2, Delta Resources.

### North Delta

The North Delta Program is composed of studies related to a through-Delta facility (TDF), Delta Cross Channel (DCC) Reoperation, a flow control facility in the Franks Tract region, and a project to improve flood management and the ecosystem along the Mokelumne River.

DWR, in cooperation with federal and State agencies, completed the fieldwork and data processing of a pilot salmon outmigration study, which was conducted to assess the feasibility of a comprehensive Delta salmon outmigration study. DWR also conducted water quality modeling analyses and prepared conceptual design layouts for alternatives considered for the Franks Tract Project and the TDF. To evaluate these alternatives, DWR conducted value engineering studies for both the Franks Tract Project and the TDF. Reclamation prepared a plan of study for the North/Central Delta Improvement Study for evaluation of the DCC, the Franks Tract Project, and the TDF.

With the North Delta Flood Control and Ecosystem Restoration Project (NDFCERP), solutions to improve flood management and the ecosystem are being considered, including setback levees, detention basins, dredging, and levee degradation for floodplain expansion.

In 2007, DWR, with the assistance of consultants, developed responses to comments received with the release of the 2006 Administrative Draft and completed the NDFCERP Draft EIR.

### South Delta

Actions in the South Delta include the South Delta Improvement Program (SDIP), implementing flood control/ecosystem improvements in the lower San Joaquin River, and potential interties between the SWP California Aqueduct and the CVP Delta-Mendota Canal.

SDIP, a component of the CALFED Bay-Delta Program, as recommended in the ROD, is a two-stage project. Stage 1 proposes to reduce the movement of San Joaquin River watershed Central Valley fall-run and late fall-run juvenile Chinook salmon into the South Delta via Old River and to maintain adequate water levels and water quality for agricultural diversions in the South Delta. Stage 2 would increase water deliveries and delivery reliability to SWP and CVP contractors south of the Delta and increase the maximum permitted level of diversion through the existing intake gates at Clifton Court Forebay to 8,500 cubic feet per second (cfs).

The SDIP Final EIR/EIS (2006) evaluated alternatives and proposed proceeding with SDIP Stage 1. This component involves constructing permanent operable gates and channel dredging in the South Delta.

DWR is proposing installation of these permanent gates to replace temporary structures currently installed and removed each year.

In 2007, Reclamation and DWR were developing a project description and biological assessment for the Operations Criteria and Plan (OCAP) that includes operation of the SDIP permanent operable gates. OCAP covers the operation of the CVP and SWP. Most planning and permitting efforts were either slowed or suspended during 2007, and permitting could not

move forward without OCAP BOs. Limited design work and modeling were completed during 2007.

Any action regarding SDIP Stage 2 will require further study and public input. Stage 2 planning was suspended during 2007.

## Environmental Water Account

Established in 2000 by the CALFED ROD, EWA is a cooperatively managed program intended to provide protection to the fish of the Bay-Delta Estuary through environmentally beneficial changes and increased flexibility in SWP and CVP operations, while maintaining water supply reliability to the projects' water users. Responsibility for implementing EWA rests with the National Marine Fisheries Service, USFWS, and DFG (the management agencies), and with Reclamation and DWR (the project agencies).

The management agencies are responsible for recommending SWP/CVP operational changes beneficial to the Bay-Delta ecosystem and the long-term survival of fish species. The project agencies are responsible for acquiring and managing EWA assets and cooperating with the management agencies in administering EWA and implementing operational changes proposed by the management agencies, as appropriate.

Under EWA, fish protection is achieved by periodically curtailing project water exports from the Bay-Delta and replacing them later, generally within the same calendar year. This replacement for reductions in Delta exports during the winter and spring necessitates the acquisition of EWA assets, which are used to replace the project water supply, generally during the summer transfer period. EWA assets consist of variable assets, which are acquired through changes in operations; fixed assets, which are acquired through water purchases from willing water sellers;

source shifting, which involves deferral of scheduled delivery of water by willing participants; and other non-water assets, such as the ability to use 500 cfs dedicated pumping capacity at Banks Pumping Plant from July 1 to September 30.

In 2001, DWR and Reclamation initiated work on a joint EIS/EIR for the EWA, which considers the environmental impacts associated with use of EWA assets, impacts on both SWP and CVP operations through December 2007, and addresses multiyear EWA contracts with willing water sellers.

The EWA project and management agencies completed and approved the EIS/EIR for the short-term EWA pertaining to the acquisition and management of EWA assets between 2004 and 2007. The *Environmental Water Account Operating Principles Agreement* was originally executed among the five State and federal agencies in 2000, and in 2004, it was extended through December 31, 2007. The agreement has not been extended past 2007.

DWR and Reclamation continue to develop a supplemental EIS/EIR to the EWA Final EIS/EIR in response to changes in the environmental settings and the need to provide an evaluation of the effects associated with EWA operations from 2008 through 2011. The Draft Supplemental EIS/EIR to the EWA Final EIS/EIR became available on October 26, 2007. It analyzes three alternatives, including two action alternatives that involve acquisition of EWA assets via stored surface water, stored groundwater, groundwater substitution, and cropland idling purchases; with EWA assets management through source shifting, groundwater storage, and borrowing project water. The alternatives differ primarily in actions taken to protect fish and the quantities of assets acquired under each. The supplement reviewed all resource areas addressed in the 2004 EIS/EIR to determine whether any changes to the regulatory or environmental settings would change the

impact conclusions in the 2004 EIS/EIR. With the exception of fisheries and aquatic ecosystems, no other resource areas produced different conclusions or findings than that of the 2004 EIS/EIR.

An addendum to the 2004 EIS/EIR was prepared to continue through December 31, 2008, certain actions to obtain assets for EWA that have been previously implemented under the certified 2004 EIS/EIR. DWR proposed to extend three agreements to obtain EWA assets by amending two agreements with Metropolitan Water District of Southern California and one agreement with Kern County Water Agency in administering EWA and implementing operational changes proposed by the management agencies.

For more details on EWA deliveries, see Chapter 9, Water Contracts and Deliveries.

### Lower Yuba River Accord

Yuba County Water Agency (Yuba) has pursued a negotiated settlement to resolve flow issues on the Yuba River associated with operation of the Yuba River Development Project. The result, the Lower Yuba River Accord (Yuba Accord), is structured to protect and enhance lower Yuba River fisheries and local water supply reliability. Additionally, Yuba has a goal to provide revenues for local flood control and water supply projects, and Reclamation and DWR have goals to obtain water for the EWA to use for protection and recovery of Delta fisheries and for improvements in statewide water supply reliability, including supplemental water for the CVP and SWP.

The Yuba Accord includes three major elements, all of which must be in place for the Yuba Accord to become effective: (1) the fisheries agreement, under which Yuba County Water Agency (Yuba) would revise the operations of the Yuba River Development Project to provide for higher

flows in the lower Yuba River under certain conditions to improve fisheries protection and enhancement and local water-supply reliability; (2) the conjunctive use agreements between Yuba and water districts within Yuba County for implementing a conjunctive use and water use efficiency program; and (3) an agreement between Yuba and DWR, pursuant to which DWR will have rights to beneficially use water made available by Yuba through the fisheries agreement, the conjunctive use agreements, and additional water releases from the Yuba project. Yuba asserts it would not and could not make these flows available from the Yuba project in the absence of the Yuba Accord and without the revenues provided to Yuba under the *Agreement for the Long-Term Purchase of Water from Yuba County Water Agency by the Department of Water Resources*.

Once the agreements are implemented, they will collectively provide significant environmental and economic benefits, including:

- higher instream flow requirements to protect lower Yuba River Chinook salmon, steelhead, and other fish species, ranging from 260,000 af in a dry year to more than 574,000 af in a wet year (an increase of 25,000 af in a dry year to more than 170,000 af in a wet year);
- improved water supply reliability for DWR and Reclamation, including a commitment of 60,000 af per year for the EWA and up to an additional 140,000 af in dry years for the SWP and CVP;
- a \$6 million long-term lower Yuba River fisheries monitoring, study, and enhancement program;
- improved water supply reliability for Yuba County farmers, along with a conjunctive water use program to improve water use efficiency for local farmers; and
- a secure funding source for Yuba and local irrigation districts to finance conjunctive water use and water use

efficiency activities, levee strengthening, and other water management actions in Yuba County.

On December 4, 2007, DWR signed an 18-year agreement with YCWA for the purchase of water for the EWA and for dry year water supplies to 22 SWP and CVP contractors. DWR purchased a total of 480,000 af of water from YCWA for delivery at the rate of 60,000 af annually from 2008 to 2015 to help offset Delta export pumping reductions to benefit at-risk fish species and improve water supply reliability. In December 2007, DWR signed agreements with several of the contractors for dry year supplies from YCWA and was in final negotiations for the remaining agreements.

See Chapter 9, Water Contracts and Deliveries, for additional details.



## **Chapter 8**

# **Water Supply**

*Antelope Lake.*

## Significant Events in 2007

Water year 2006–2007 proved to be very dry, with much less than average precipitation and snowpack. Only 2 of the 5 wet season months, November through March, were above average in precipitation and two, January and March, were abnormally dry. As a result, statewide precipitation was only 65 percent of average in 2006–2007. The northern regions of the State did better than the southern regions, with precipitation amounts ranging from 83 percent on the North Coast to 29 percent in the Colorado Desert region. The mountain snowpack, too, was poor and peaked about a month early around the first of March at 60 percent of the normal April 1 snowpack water content. March was unusually warm and dry and by April 1 the pack had been reduced to 39 percent of average

Statewide river runoff totaled 53 percent of average in the 2006–2007 water year. Runoff in the Sacramento River and San Joaquin River regions was 55 percent and 43 percent of average, respectively. Feather River unimpaired inflow to Lake Oroville was 2.5 million acre feet (maf) (55 percent of average) for the water year, compared with 8.2 maf (178 percent of average) the previous year. Estimated statewide reservoir storage in water year 2006–2007 started out strong at 122 percent of average on October 1, as a result of a wet 2006, but declined during the year to 84 percent at the end of September.

The Sacramento Valley Water Year Hydrologic Classification (40-30-30 Index) and the San Joaquin Valley Water Year Hydrologic Classification (60-20-20 Index) were dry and critical, respectively, based on observed data for water year 2006–2007.

*Information in this chapter was contributed by the Division of Flood Management and the Division of Operations and Maintenance.*

The Department of Water Resources (DWR) monitors precipitation, calculates runoff, and operates storage facilities during each water year. The official California water year runs from October 1 through September 30. DWR works during the water year to fulfill its key contractual obligations to the State Water Project (SWP) long-term water supply contractors.

## Water Year 2006–2007

### Precipitation and Snowpack

California experienced significantly less than average rainfall and mountain snowpack during water year 2006–2007. The State, as a whole, received precipitation at 65 percent of average in 2006–2007, as compared with 136 percent of average in 2005–2006. Figure 8-1 presents water year precipitation for the various regions of the State. The Northern Sierra 8-Station Index finished the water year with 37.2 inches of precipitation, which was 74 percent of average.

The statewide average snow water equivalent, based on snow sensors, reported for April 1 was 13 inches, or 45 percent of average. Snowpack peaked early on February 28 with 17 inches of snow water content. Historically, April 1 is the average annual date of peak snow accumulation.

Table 8-1 presents monthly precipitation totals for water year 2006–2007 at various gauges located throughout the State, listed north to south. For much of the State, the two wettest months were December and February, when precipitation totals nearly exceeded 200 percent of average in a few locations.

Mount Shasta City, in far Northern California, received 30.0 inches of precipitation for a water year total which was 83 percent of average. Precipitation was heaviest during the months of December, February, and July, with precipitation totaling 173, 171, and 224 percent of average, respectively.

Blue Canyon experienced precipitation above normal for 6 months of water year 2006–2007. The month of February accumulated the largest monthly precipitation for the water year, 19.2 inches, which was 197 percent of average. The highest percent of normal value for the water year was 238 percent, in September. However, this only amounted to 1.8 inches of precipitation.

In the San Joaquin and Tulare Lake watersheds, precipitation was less intense than in the north. The December storms did bring above-average (114 percent) precipitation to Yosemite Headquarters. The February storms totaled 127 percent of average at Grant Grove. However, water year precipitation totals in those two locations were 61 and 56 percent of their respective annual averages. In the South Central watershed, the cities of Los Angeles and San Diego were even drier, totaling 26 and 37 percent of their annual averages, respectively.

The monthly totals for the Northern Sierra 8-Station Index (see sidebar, Precipitation and Water Supply Indices) for water year 2006–2007 are presented in Table 8-2. Precipitation for the water year totaled 37.2 inches, which is 74 percent of average. Monthly precipitation totals for December, February, and July were above average at 101, 170, and 250 percent of average, respectively. January and March, conversely, each registered as the sixth driest on record for the index. Following the wet February, the rest of the water year was quite dry and unusually warm.





Figure 8-1 Statewide Precipitation by Hydrologic Region, 2006–2007 Water Year, as Percent of Average

**Table 8-1 Monthly Precipitation Totals at Various Locations in California during Water Year 2006–2007**

Monthly Precipitation (in inches)												
Station	2006			2007								
	Oct	Nov	Dec	Jan	Feb	Mar	Apr	May	Jun	Jul	Aug	Sep
Mount Shasta City	0.18	4.05	10.20	0.86	9.57	1.64	1.51	0.69	0.30	0.56	0.03	0.39
% of avg	8	88	173	13	171	37	54	41	28	224	10	49
Eureka Woodley Island	0.58	7.41	7.09	1.86	11.86	2.51	2.72	0.86	0.46	0.97	0.08	0.60
% of avg	19	134	111	29	229	48	95	48	75	882	33	79
Blue Canyon (DWR-2)	1.00	8.42	11.24	2.78	19.17	1.99	5.46	2.10	0.92	0.00	0.01	1.76
% of avg	27	107	107	22	197	23	109	77	105	0	3	238
Sacramento WB City	0.21	1.03	3.12	0.07	5.17	0.50	1.42	0.43	0.00	0.01	0.00	0.08
% of avg	23	51	98	2	158	21	96	93	0	33	0	38
San Francisco WB AP	0.63	3.05	5.31	0.72	4.79	0.52	1.44	0.43	0.00	0.02	0.00	0.09
% of avg	59	129	143	16	146	19	101	98	0	67	0	47
Yosemite Headquarters	0.65	1.51	7.48	0.82	4.72	1.86	1.88	0.67	0.15	0.00	1.92	0.69
% of avg	38	36	114	12	75	38	58	48	26	0	960	111
Fresno WB AP	0.08	0.23	1.33	0.59	2.29	0.97	0.49	0.05	0.00	0.00	0.02	0.02
% of avg	17	21	76	29	110	52	45	18	0	0	100	13
Grant Grove	0.84	0.93	4.54	1.65	9.19	2.82	2.77	0.21	0.00	0.00	0.02	1.58
% of avg	43	18	58	22	127	37	64	18	0	0	29	293
Los Angeles-WSO Airport	0.00	0.25	0.61	0.39	0.82	0.09	0.36	0.00	0.00	0.01	0.00	0.49
% of avg	0	18	29	14	28	5	39	0	0	100	0	272
San Diego NWS-Lindbergh	0.76	0.15	0.71	0.51	1.12	0.09	0.46	0.00	0.00	0.00	0.00	0.05
% of avg	181	13	37	25	58	6	61	0	0	0	0	28

**Table 8-2 Northern Sierra 8-Station Precipitation for Water Year 2006–2007**

	Month	Precipitation (inches)	Percent of Monthly Average Precipitation
2006	October	0.51	17
	November	5.65	90
	December	8.49	101
2007	January	1.44	16
	February	13.6	170
	March	1.65	24
	April	3.09	79
	May	1.16	55
	June	0.37	37
	July	0.50	250
	August	0.01	3
	September	0.74	82
	<b>Total</b>	<b>37.21</b>	<b>74</b>

Taking the entire water year into consideration, 60 percent of the water year total precipitation fell during December and February, essentially during three stormy periods: December 8 to December 27, 8.2 inches; February 6 to February 12, 6.8 inches; and February 20 to February 28, 6.6 inches.

Areas of the Central Valley received above normal precipitation in February only. Precipitation totals for the month were 5.2 inches for Sacramento (158 percent of average) and 2.3 inches for Fresno (110 percent of average).

The precipitation that fell during water year 2006–2007 resulted in a snowpack well below average throughout the State’s mountainous regions. Monthly statewide snowpack for the 2006–2007 water year is shown in Table 8-3. Snow water equivalents

shown in the table were obtained from daily snow sensor reports corresponding to the first day of each month.

The statewide average snow water equivalent reported for April 1 was 13 inches, (no statewide average for the courses

is available), or 45 percent of average (39 percent of average, if courses are used). Snowpack peaked early on February 28 with 17 inches of snow water content. Not only was the peak observed one month earlier than normal (April 1 is typically the average annual date of peak snow accumulation), it was 58 percent of the April 1 average.

**Table 8-3 Statewide Snowpack for Water Year 2006–2007**

Date	Snow Water Equivalent (in inches)	Percent of Average	Percent of April 1 Average <sup>a</sup>
2006	October 1	0	0
	November 1	0	0
	December 1	2	36
2007	January 1	6	61
	February 1	7	42
	March 1	17	66
	April 1	13	45
	May 1	6	27
	June 1	0	0

<sup>a</sup> April 1 is the average date of peak statewide snowpack.

### Runoff and Storage

Statewide river runoff totaled 53 percent of average in the 2006–2007 water year. The monthly runoff totals for the Sacramento River (see sidebar), San Joaquin River, Tulare Lake, and Feather River regions are shown in Table 8-4. The water year runoff totals for these regions were 55, 42, 37, and 55 percent of average, respectively.

From a water supply perspective, the most closely monitored period is April through July. April concluded with 51, 63, and 57 percent of normal runoff for the Sacramento River, San Joaquin River, and Tulare Lake regions, respectively. By the end of July, the April–July runoff volumes had

**Table 8-4 Unimpaired Runoff for Water Year 2006–2007 (million acre-feet)**

	Oct	Nov	Dec	Jan	Feb	Mar	Apr	May	Jun	Jul	Aug	Sep	WY
SRR runoff	0.45	0.62	1.22	0.78	1.88	1.64	1.21	0.99	0.46	0.38	0.33	0.33	10.28
% average	86	70	69	30	71	57	51	43	37	63	78	80	55
SJR runoff	0.06	0.06	0.10	0.10	0.26	0.42	0.53	0.68	0.19	0.06	0.04	0.03	2.51
% average	101	43	38	22	55	69	63	48	18	13	28	41	42
TLR runoff	0.05	0.04	0.05	0.05	0.08	0.17	0.23	0.31	0.10	0.04	0.02	0.02	1.16
% average	102	64	44	30	40	62	57	42	16	12	24	34	37
Feather River runoff	0.10	0.14	0.28	0.18	0.47	0.44	0.31	0.23	0.11	0.11	0.09	0.08	2.54
% average	84	67	70	31	77	61	48	35	33	73	91	88	55
<b>Statewide % average</b>	<b>82</b>	<b>61</b>	<b>76</b>	<b>30</b>	<b>68</b>	<b>64</b>	<b>54</b>	<b>46</b>	<b>26</b>	<b>35</b>	<b>59</b>	<b>69</b>	<b>53</b>

SRR: Sacramento River Region

Sacramento River at Bend Bridge, Feather River at Oroville, Yuba River at Smartville, American River at Folsom

SJR: San Joaquin River Region

Stanislaus River below Goodwin, Tuolumne River at La Grange, Merced River below Merced Falls, San Joaquin River at Friant

TLR: Tulare Lake Region

Kings River at Pine Flat, Kaweah River at Terminus, Tule River at Success, Kern River at Isabella

WY: Water Year (Oct–Sep)

dropped to 47, 38, and 33 percent of average for the three respective regions.

The Sacramento Valley Water Year Hydrologic Classification (40-30-30 Index) and the San Joaquin Valley Water Year Hydrologic Classification (60-20-20 Index) were “dry” and “critical”, respectively, based on observed data for water year 2006–2007 (see sidebar).

During water year 2006–2007, statewide reservoir storage was at its peak of 124 percent of average in October, following the very wet 2005–2006 water year, and declined steadily to a low of 85 percent of average during the summer months of

July to September. Monthly storage totals for the major Sierra reservoirs are shown in Table 8-5. End-of-water-year storage in the major Sierra reservoirs ranged from 108 percent of average in the New Melones Reservoir on the Stanislaus River to 27 percent of average in the Success Reservoir on the Tule River.

## Water Year 2007–2008 October through December Water Conditions

The last three months of calendar year 2007 mark the beginning of a new water year, 2007–2008.

**Table 8-5 Reservoir Storage for Water Year 2006–2007 (thousand acre-feet)**

Reservoir	Oct	Nov	Dec	Jan	Feb	Mar	Apr	May	Jun	Jul	Aug	Sep
Shasta	3,119	3,127	3,335	3,374	3,772	4,011	3,901	3,601	3,141	2,560	2,134	1,879
% of avg	113	113	115	108	112	107	98	91	84	77	72	67
Oroville	2,760	2,680	2,793	2,795	3,009	3,123	3,078	2,965	2,644	2,194	1,823	1,568
% of avg	128	122	125	117	119	113	105	97	90	83	77	70
Folsom	538	488	482	468	589	693	740	787	656	490	376	323
% of avg	108	104	100	91	106	111	101	94	79	69	61	58
San Luis	1,461	1,651	1,922	1,943	1,896	1,792	1,567	1,023	510	412	477	639
% of avg	132	132	137	120	108	96	84	61	38	40	54	64
Pardee	167	165	163	161	176	182	183	193	191	196	187	179
% of avg	96	94	92	90	98	100	101	102	99	103	102	100
New Melones	1,988	1,994	1,992	1,977	2,001	1,979	1,909	1,778	1,673	1,573	1,492	1,437
% of avg	153	151	148	142	139	133	129	119	110	108	109	108
Don Pedro	1,612	1,597	1,600	1,607	1,644	1,641	1,610	1,612	1,525	1,401	1,301	1,266
% of avg	124	122	120	116	115	111	110	105	95	91	91	93
Millerton	241	253	248	237	209	246	295	347	300	226	186	200
% of avg	128	116	89	70	61	68	81	85	72	69	81	99
Pine Flat	410	435	468	492	513	560	640	698	508	267	187	185
% of avg	117	116	112	103	96	100	105	97	73	51	48	53
Kaweah	14	17	23	15	25	52	88	129	91	35	14	12
% of avg	130	135	149	72	103	134	122	112	89	69	73	95
Success	6	7	9	11	17	25	32	34	22	6	5	4
% of avg	65	69	72	60	67	74	71	61	41	17	23	27
Isabella	231	226	227	223	222	226	231	241	210	158	126	114
% of avg	145	150	147	132	123	116	103	82	68	59	60	62
<b>Statewide % avg</b>	<b>125</b>	<b>120</b>	<b>120</b>	<b>110</b>	<b>110</b>	<b>110</b>	<b>105</b>	<b>95</b>	<b>90</b>	<b>85</b>	<b>85</b>	<b>85</b>

## Precipitation and Water Supply Indices

### Northern Sierra 8-Station Index

In the northern Sierra Nevada, precipitation is indexed by averaging rain gauge totals at eight representative stations creating what is known as the Northern Sierra 8-Station Index. The eight stations are: Mount Shasta City, Shasta Dam, Mineral, Quincy, Brush Creek, Sierraville Ranger Station, Blue Canyon, and Pacific House. The 8-Station Index provides a representative sample of the major watersheds (upper Sacramento, Feather, Yuba, and American rivers) and serves as a wetness index for the Sacramento River hydrologic region.

### Sacramento River Runoff

Sacramento River runoff is the sum of unimpaired flow in million acre-feet (maf) at the Sacramento River above Bend Bridge, Feather River at Oroville (inflow to Lake Oroville), Yuba River near Smartville, and American River below Folsom Lake. The Sacramento Valley unimpaired runoff represents the natural water production of the Sacramento River basin, unaltered by upstream diversions, storage, or export of water to or import of water from other basins.

Also known as the "Sacramento River Index," this index was previously used to determine year type classifications under State Water Resources Control Board (SWRCB) Water Right Decision 1485. Also previously referred to as the "4 River Index" or "4 Basin Index".

### Eight River Index

This index is the sum of the unimpaired runoff from eight rivers—four in the Sacramento Valley (same as those used to calculate the Sacramento River Index) and four in the San Joaquin Valley: Stanislaus River inflow to New Melones Reservoir; Tuolumne River inflow to New Don Pedro Reservoir; Merced River inflow to Lake McClure; and San Joaquin River inflow to Millerton Lake.

This index determines the duration of the fish and wildlife salinity and flow standards at Chipps Island or Port Chicago from February through June.

### Sacramento Valley 40-30-30 Index

SWRCB Water Right Decision 1641 (D-1641) applies the Sacramento Valley Water Year Hydrologic Classification (Sacramento Valley 40-30-30 Index), a water supply forecasting tool, to derive the water year type for the Sacramento Valley. Previously, the Sacramento River Index was used to classify types of water years. SWRCB first introduced the Sacramento Valley 40-30-30 Index in the 1991 Water Quality Control Plan for the San Francisco Bay/Sacramento-San Joaquin Delta Estuary (Bay-Delta Plan), and continued using it with the 1995 Bay-Delta Plan. D-1641 implements portions of the 1995 Bay-Delta Plan with respect to the operation of the State Water Project and the Central Valley Project. The Sacramento Valley 40-30-30 Index is used to determine the Sacramento Valley water year type for the purpose of implementing water quality objectives defined in D-1641. It also provides an estimate of the potential water supply originating in a basin from rainfall and snowmelt runoff, groundwater accretion, and reservoir carryover storage. The Sacramento Valley 40-30-30 Index incorporates seasonal differences in water contribution for the year and includes the prior year's conditions in order to establish a more reliable index of water availability. The 40-30-30 factors represent the percentage weight given to the following:

- (1) 40%—the current year's April through July Sacramento Valley unimpaired runoff;

- (2) 30%—the current year’s October through March Sacramento Valley unimpaired runoff; and
- (3) 30%—the previous year’s index with a cap of 10 maf (to account for required flood control reservoir releases during wet years).

The water year type is determined by where the index value falls on a scale specific to the Sacramento Valley (as defined in D-1641).

Classification	Index (maf)
Wet	Equal to or greater than 9.2
Above Normal	Greater than 7.8 and less than 9.2
Below Normal	Equal to or less than 7.8 and greater than 6.5
Dry	Equal to or less than 6.5 and greater than 5.4
Critical	Equal to or less than 5.4

Year types are set by the first-of-the-month forecasts beginning in February, and the Sacramento Valley 40-30-30 Index May 1 forecast determines the final water year type for implementing water quality and flow requirements contained in D-1641. The D-1641 objectives are conditioned by water year type and generally become less stringent during dryer years.

**San Joaquin Valley 60-20-20 Index**

D-1641 uses a similar method to determine the water year type for the San Joaquin Valley. The San Joaquin Valley Water Year Hydrologic Classification (San Joaquin Valley 60-20-20 Index) uses (1) the current year’s April through July San Joaquin Valley unimpaired runoff (60 percent); (2) the current year’s October through March San Joaquin Valley unimpaired runoff (20 percent); and (3) the previous year’s San Joaquin Valley 60-20-20 Index (20 percent, with a cap of 4 maf to account for required flood control reservoir releases during wet years).

The water year type is determined by where the index value falls on a scale specific to the San Joaquin Valley (as defined in D-1641).

Classification	Index (maf)
Wet	Equal to or greater than 3.8
Above Normal	Greater than 3.1 and less than 3.8
Below Normal	Equal to or less than 3.1 and greater than 2.5
Dry	Equal to or less than 2.5 and greater than 2.1
Critical	Equal to or less than 2.1

The San Joaquin Valley 60-20-20 Index May 1 forecast determines the water year type for D-1641 San Joaquin River Vernalis flow standards.

October generally provided above average precipitation for the northern half of the state and below average rainfall for the southern half, November was extremely dry statewide, and December was slightly less than average throughout most of the state. At the end of October, water year runoff totals were 90, 47, and 46 percent of average for the Sacramento River, San Joaquin River, and Tulare Lake regions, respectively. By the end of December, runoff totals for the new water year were 47, 22, and 35 percent of average, respectively, for the same three regions.

## State Water Project Storage

The State Water Project (SWP) operates a complex system of dams and reservoirs to collect and store water for future deliveries. Lake Oroville is the first of two primary SWP conservation facilities. Inflow into Lake Oroville comes from tributaries of the Feather River.

The San Luis Reservoir is the second primary SWP conservation facility. This Central California facility derives its inflow from pumping at the Gianelli Pumping-Generating Plant. San Luis is an off-stream storage reservoir. Most of the water is pumped into the reservoir from late fall to early spring. This water is temporarily stored, then released to the California Aqueduct to meet water contractor peaking demands in the summer months. The remaining SWP dams and reservoirs regulate the stored water supply in delivery patterns that are designed to fit local water demands.

## Water Year 2006–2007 Storage Totals

At the end of the 2006–2007 water year, water storage in all SWP reservoirs was 2.72 maf or 50 percent of maximum storage, compared to 4.4 maf or 82 percent of maximum storage at the end of water year 2005–2006. The average end-of-month total storage for the 2006–2007 water

year in major SWP reservoirs was 3.98 maf. End-of-water-year storage on September 30, 2007, at Lake Oroville was 1.57 maf, which was about 1.26 maf less than the previous water year. The State's share of San Luis Reservoir storage at the end of the 2006–2007 water year was 445,112 af, as compared with 911,032 af in the previous water year. The combined storage in southern reservoirs was 618,703 af on September 30, 2007, as compared with 572,800 af at the end of the 2005–2006 water year.

## Calendar Year 2007 Storage Totals

The total storage in major SWP reservoirs was about 2.45 maf at the end of calendar year 2007, as compared with 4.49 maf in 2006. The State's share of San Luis Reservoir storage was 663,928 af on December 31, 2007, as compared with 1,242,330 af at the same time in 2006. The combined storage in the southern reservoirs was 556,671 af on December 31, 2007, as compared with 458,487 af at the same time in 2006.

## Lake Oroville

Lake Oroville is the keystone of the SWP. It has a maximum water storage capacity of 3,537,580 af. Runoff from Feather River drainage is collected and stored in this reservoir. This water is released to the Sacramento-San Joaquin Delta through Oroville Dam, Thermalito Diversion Dam, and Thermalito Afterbay.

## Water Year 2006–2007 Inflow

Lake Oroville inflow for the 2006–2007 water year totaled about 2.33 maf, which was 55 percent of the 30-year average (4.25 maf). Maximum daily inflow occurred on February 10, 2007, at 53,980 af. Minimum daily inflow occurred on September 21, 2007, at 238 af. Peak monthly total inflow (for the 2006–2007 water year) occurred in February 2007, at 378,419 af, 16 percent of the water year total of 2,330,851 af.

The maximum total in 30 years was in water year 1982–1983 at 8,853,572 af. The minimum total in 30 years was in water year 1976–1977 at 1,555,774 af. (See Figures 8-2 and 8-3 for calendar year and cumulative inflows, respectively, into Lake Oroville.)

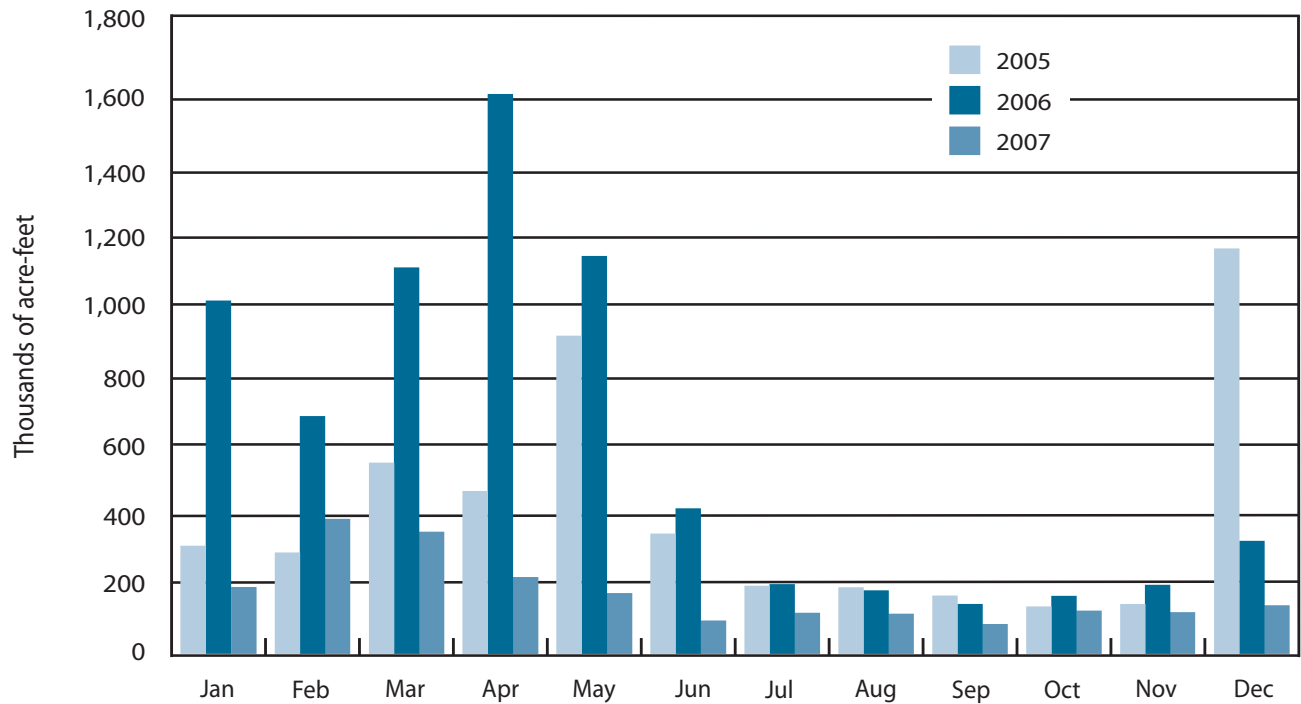
### Calendar Year 2007 Inflow and Storage

Total inflow into Lake Oroville during the calendar year was 2,026,586 af. Minimum storage occurred on December 31, 2007, at 1,226,833 af, 35 percent of its capacity. Maximum storage occurred on April 4, 2007, at 3,135,623 af, 89 percent of its capacity. End-of-year Lake Oroville storage was 1,226,833 af. Figure 8-4 compares end-of-month storage in Lake Oroville for the 2006 and 2007 calendar years.

### 2006–2007 Water Year San Luis Reservoir Operations

San Luis Reservoir is operated jointly by DWR and the Bureau of Reclamation per operating procedures adopted in June 1981. San Luis Reservoir has a normal operating capacity of 2,027,840 af. The SWP share of this capacity is 1,062,183 af.

San Luis Reservoir reached its maximum water year total storage on January 14, 2007, at 2,013,241 af, 99 percent of its normal maximum operating capacity. At the beginning of the water year, San Luis Reservoir contained 1,318,075 af, 65 percent of its capacity. SWP storage share at the beginning of the water year was 916,668 af. The highest end-of-month SWP share of water storage for the 2006–2007 water year occurred in December 2006, at 1,242,330 af. (See Figure 8-5.)



**Figure 8-2 Monthly Inflow into Lake Oroville from the Feather River, 2005–2007 Calendar Years**



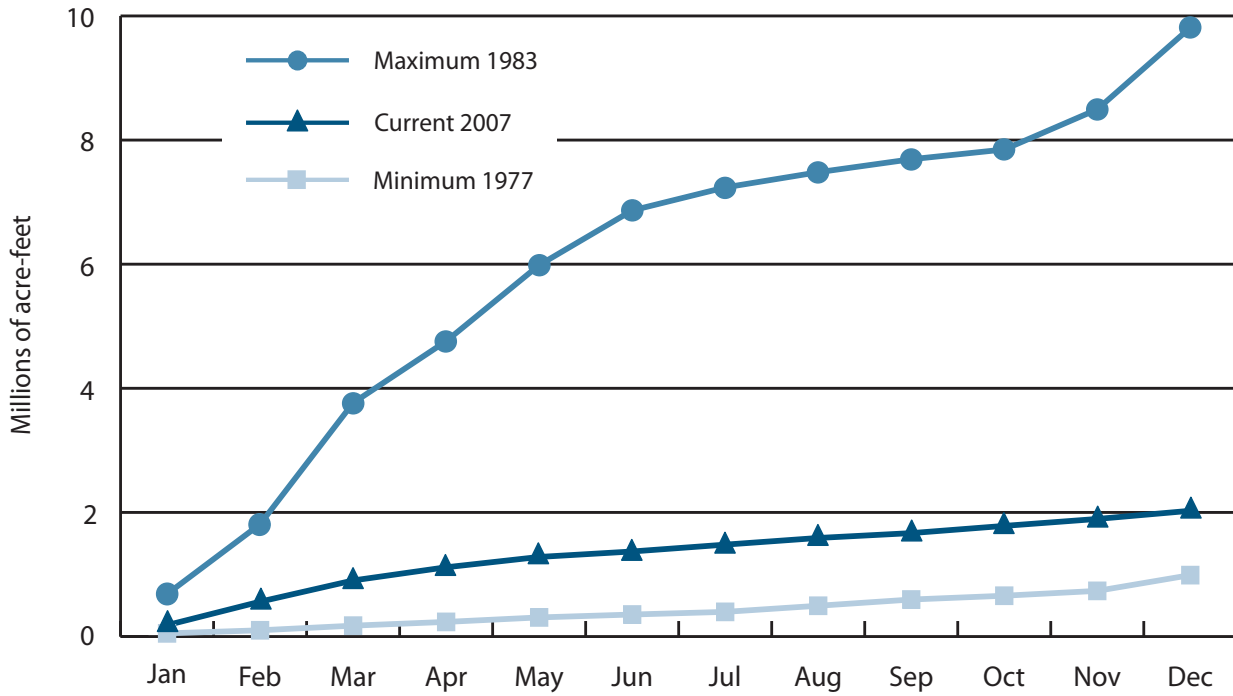


Figure 8-3 Cumulative Maximum, Minimum, and Current Lake Oroville Inflow

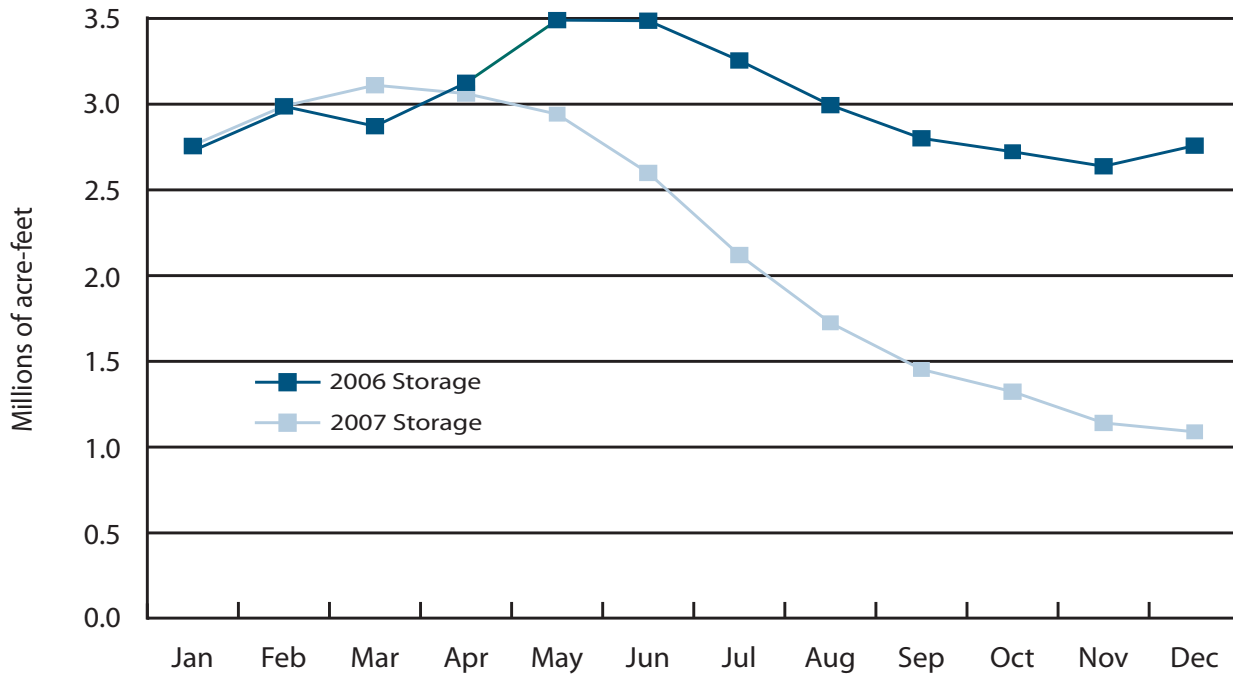
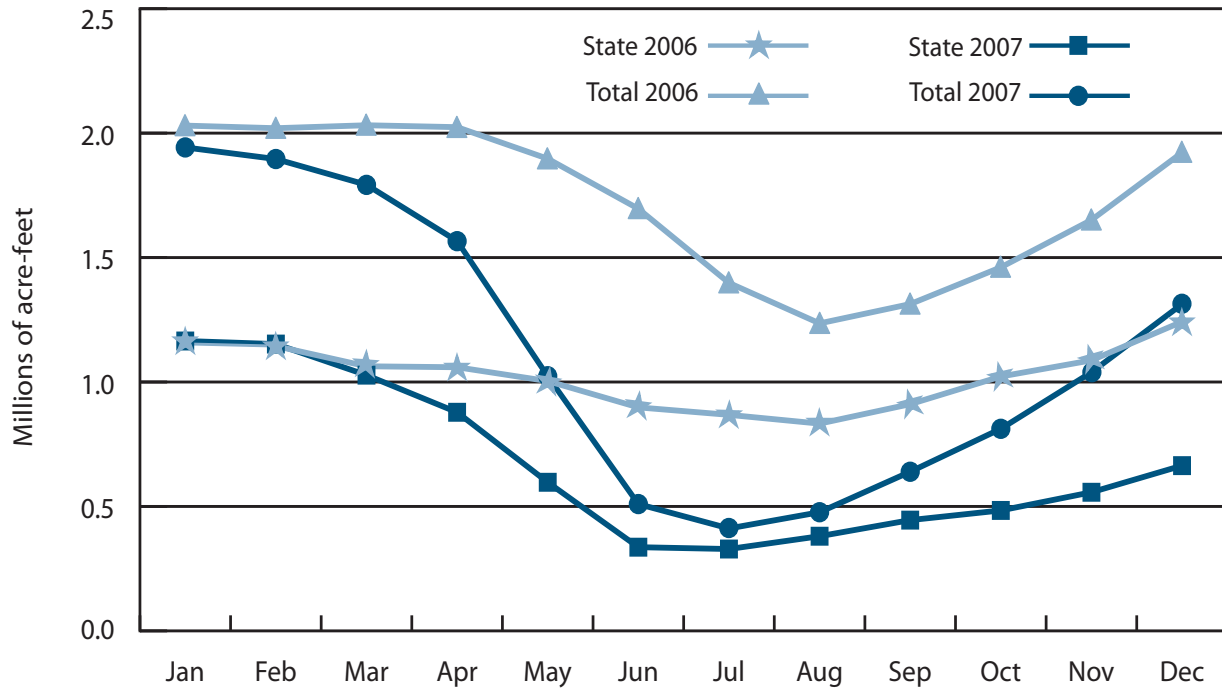


Figure 8-4 End-of-Month Storage in Lake Oroville, 2006 and 2007 Calendar Years



**Figure 8-5 End-of-Month Storage in San Luis Reservoir, 2006 and 2007 Calendar Years**

### 2006–2007 Water Year Lake del Valle Operations

Lake del Valle, which is situated off the South Bay Aqueduct, functions primarily as a storage facility for later water delivery into Santa Clara and Alameda counties. At the beginning of the water year, Lake del Valle held 35,742 af, which was about 46 percent of its maximum capacity of 77,106 af. Its highest storage during the 2006–2007 water year occurred on May 23, 2007, at 41,511 af. Its lowest storage occurred on December 18, 2006, at 24,644 af.

By the end of the water year, on September 30, 2007, storage in Lake del Valle was 32,724 af, 42 percent of maximum capacity of 77,106 af. There were no releases to Arroyo Valle and releases for the water year to the South Bay Aqueduct from Lake del Valle totaled 17,881 af.

### 2006–2007 Water Year Southern Reservoir Operations

During normal operating conditions, DWR maintains its four southern reservoirs—Pyramid, Castaic, Silverwood, and Perris—at or near full operating capacity to ensure uninterrupted delivery of water to Southern California contractors.

At the beginning of the water year, these reservoirs held 572,800 af, with 83 percent of their combined normal maximum operating capacity of 689,021 af. At the end of the water year, the reservoirs held 618,703 af, 90 percent of combined normal maximum operating capacity.

### Diversions from the Delta

SWP diverts water from the Sacramento-San Joaquin Delta, through Banks and Barker Slough pumping plants, for delivery to SWP water contractors’ storage facilities. In 2007, the SWP diverted 2,396,391 af at

Banks Pumping Plant. Cross Valley Canal wheeling at Banks Pumping Plant totaled 24,221 af and Central Valley Project (CVP) water wheeled at Banks Pumping Plant by DWR during 2007 totaled 83,257 af. The CVP diverted 2,586,383 af at the Jones Pumping Plant and 111,350 af at the Contra Costa Pumping Plant. The combined Delta exports include all of these plants. Figure 8-6 shows the amounts of water pumped each month in 2007 at the Banks Pumping Plant. Figure 8-7 shows the monthly amounts of water diverted from the Delta in 2007 by the SWP and CVP. CVP diverts water to similar areas from the Delta through Jones Pumping Plant and Contra Costa Pumping Plant.

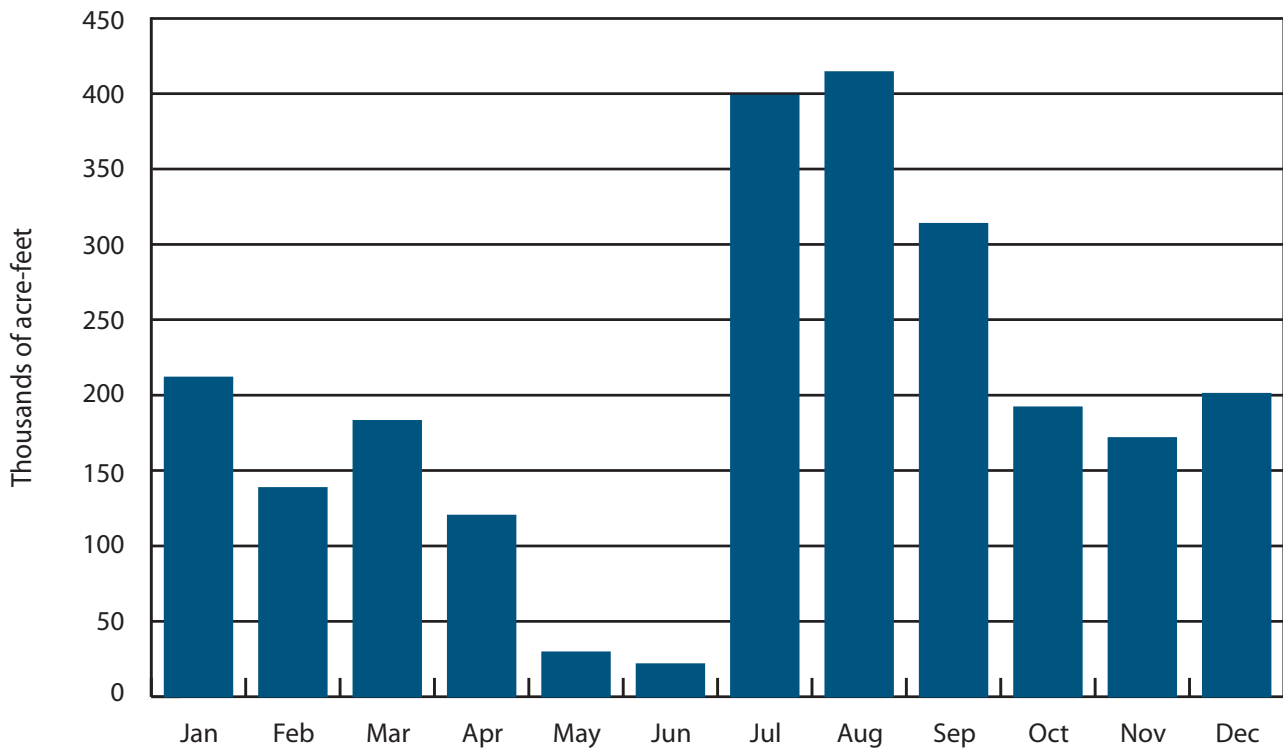
Water is delivered from Banks Pumping Plant to the South Bay Area through the South Bay Aqueduct and to the San Joaquin Valley, Central Coastal, and Southern California areas through the California Aqueduct. The SWP diverts water from Barker Slough Pumping Plant to the North Bay Aqueduct.

In 2007, the North Bay Aqueduct received 59,464 af of project water from the Barker Slough Pumping Plant.

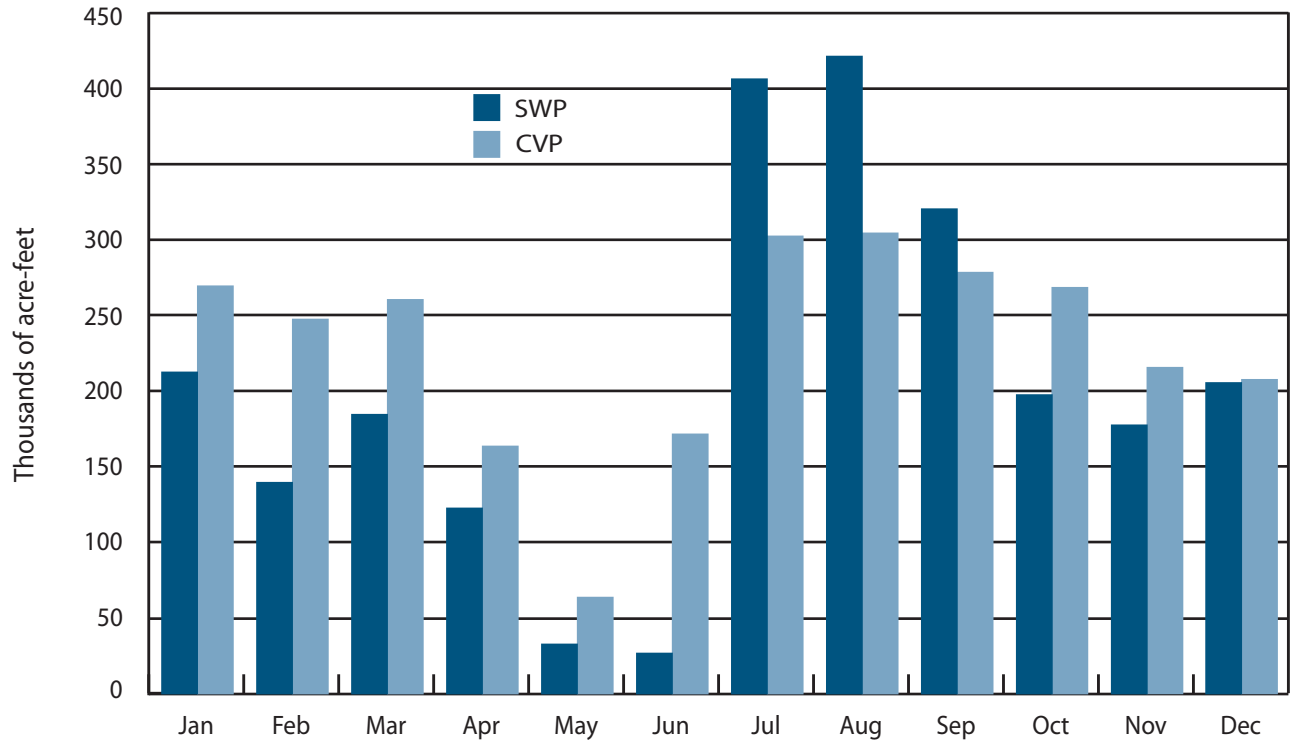
Dos Amigos Pumping Plant diverts water from O'Neill Forebay to the California Aqueduct. Figure 8-8 shows monthly total amounts pumped at Dos Amigos Pumping Plant for calendar year 2007. Pumping peaked in July 2007 at 364,499 af.

Maximum daily Delta exports occurred on July 15, 2007, at 25,309 af. Combined SWP and CVP monthly Delta exports in 2007 varied from a low of 92,657 af in May, to a high of 695,362 af in August. In 2007, Delta exports totaled approximately 5.09 maf.

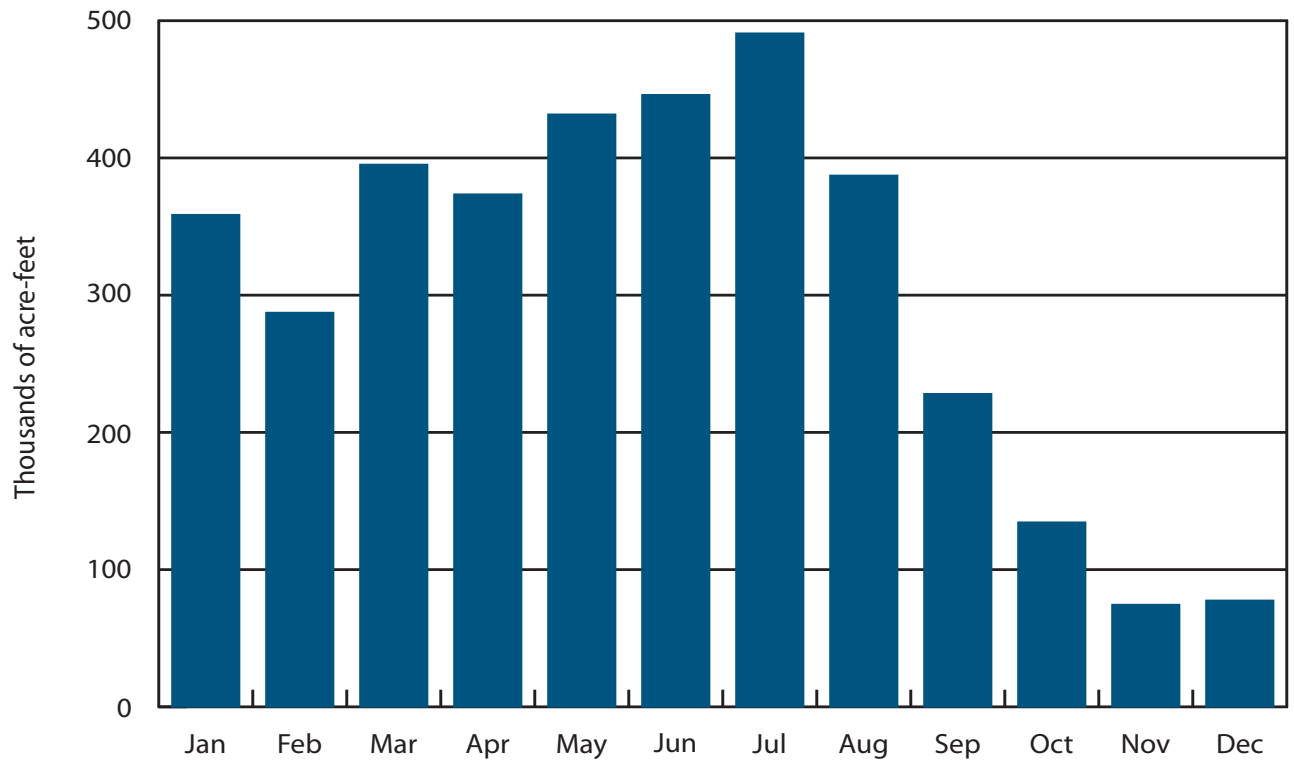
In 2007, water pumped through the Edmonston Pumping Plant for delivery to Southern California totaled 2,037,144 af. Figure 8-9 shows the amount of water pumped each month in 2007.



**Figure 8-6** Water Pumped at Banks Pumping Plant, 2007 Calendar Year

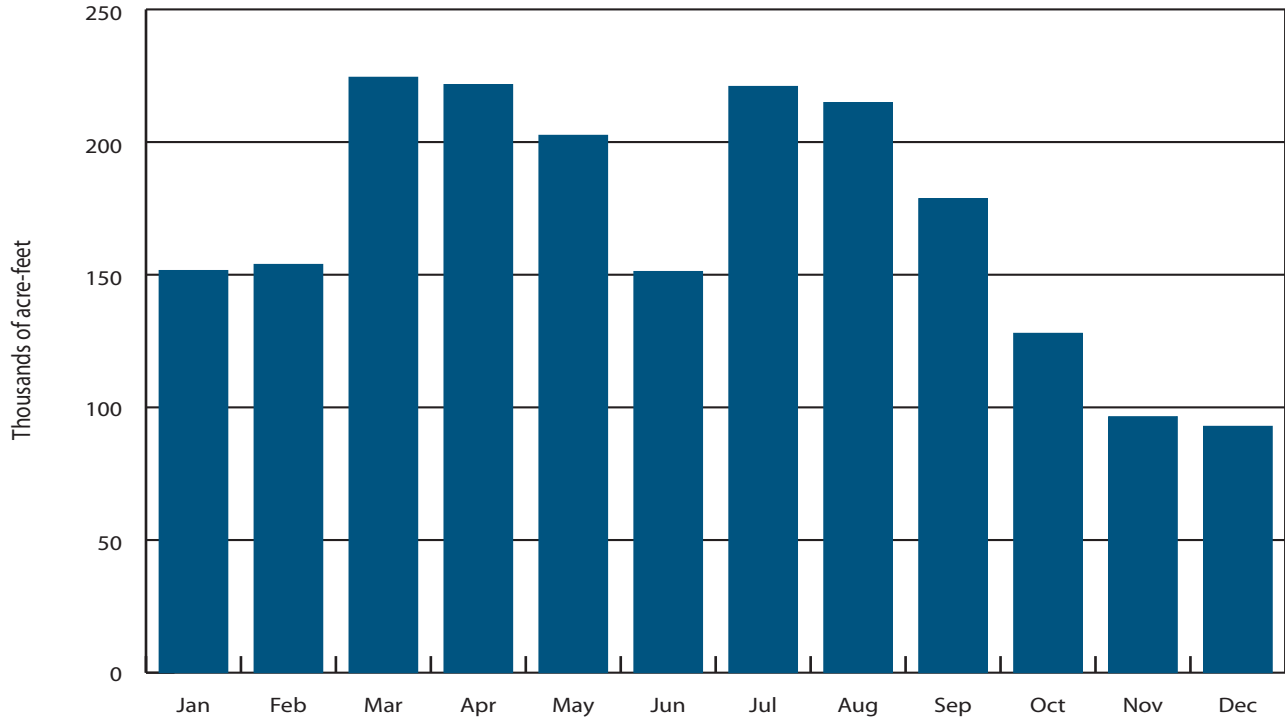


**Figure 8-7 Sacramento-San Joaquin Delta Exports by State Water Project and Central Valley Project, 2007 Calendar Year**



**Figure 8-8 Water Pumped at Dos Amigos Pumping Plant, 2007 Calendar Year**

For more information, see the water supply information website at [http://cdec.water.ca.gov/water\\_supply.html](http://cdec.water.ca.gov/water_supply.html).



**Figure 8-9** Water Pumped at Edmonston Pumping Plant, 2007 Calendar Year



## **Chapter 9**

# **Water Contracts and Deliveries**

*Oroville Lake and Dam.*

## Significant Events in 2007

The draft environmental impact report (EIR) for the Monterey Amendments was released for public review and comment in October 2007.

In 2007, the Sacramento Valley 40-30-30 Index classified the water year in the Sacramento Valley as “dry,” and the San Joaquin Valley 60-20-20 Index classified that region’s water year as “critical.” The Department of Water Resources (DWR) was able to approve 60 percent of all State Water Project (SWP) water contractors Table A requests, amounting to 2,466,224 af. The total Table A water delivered to all SWP water contractors in calendar year 2007 was 1,986,455 af.

On December 4, 2007, DWR signed an 18-year agreement with Yuba County Water Agency (YCWA) for the purchase of water for the Environmental Water Account and for dry year water supplies to 22 SWP and Central Valley Project (CVP) contractors. DWR purchased a total of 480,000 af of water from YCWA for delivery at the rate of 60,000 af annually from 2008–2015 to help offset Delta export pumping reductions to benefit at-risk fish species and improve water supply reliability. In December 2007, DWR signed agreements with several of the contractors for dry year supplies from YCWA, and was in final negotiations for the remaining agreements.

*Information for this chapter was provided by the State Water Project Analysis Office.*

The long-term water supply contracts between the Department of Water Resources (DWR) and 29 public agencies and local water districts provide for water service from the State Water Project (SWP) and are the basis for the SWP's construction and on-going operations. The State provides SWP financing, capital construction, improvements, and all operations and maintenance of SWP facilities and the agencies have contractually agreed to repay all associated costs.

The contracts also set forth the maximum amount of water a contractor may request each year from the SWP and these are written within the contracts in a list format known as Table A. "Table A" or "Table A water" represents a portion or all of the annual Table A requested by the SWP water contractors and approved for delivery by DWR, based on hydrologic conditions, current reservoir storage, and combined requests from the SWP water contractors. Under certain conditions DWR is not able to deliver the quantity of water requested by contractors. In these years, a lesser amount is allocated and delivered according to the long-term water supply contracts by prorating the amount in proportion to each SWP water contractor's maximum Table A amount. Table A amounts may also be used as a factor to allocate other available water supplies to each contractor. Approved Table A amounts may also be referred to in this chapter as "approved amounts," "approved water," or "allocated water". Long-term water supply contracts can be found at <http://www.water.ca.gov/swpao/wsc.cfm>.

The long-term water supply contracts are amended as needed. During 2007, eleven amendments were executed; however, eight will not become effective until 2010. All newly executed amendments are further described in this chapter.

DWR also enters into agreements with SWP water contractors, corporations, and other water agencies, which may be amended

periodically, to convey SWP and non-SWP water through the California Aqueduct and to approve the construction, operation, and maintenance of turnouts along SWP facilities. These agreements are listed in this chapter.

The State Water Project Analysis Office (SWPAO) developed a numbering system for contracts, amendments, and agreements executed by DWR. These numbers, referred to as SWPAO numbers, are designated in Chapter 9 text as "SWPAO #XXXXX" and are located in parentheses after each contract, amendment, or agreement description. These numbers can be used as an identifier for anyone who contacts DWR staff for more detailed information on a particular document.

## Amendments to Long-Term SWP Water Supply Contracts

All the original contracts signed by DWR and public and local agencies have been previously amended to incorporate mutually desired changes. Most amendments fall under the following five general categories:

1. revision of annual Table A amounts in the water supply contracts;
2. allocation of costs and benefits for the enlargement or extension of the East Branch and extension of the Coastal Branch of the California Aqueduct;
3. purchase of excess capacity in the California Aqueduct;



## SWP Long-Term Water Supply Contracts

The first water supply contract was signed with the Metropolitan Water District of Southern California (Metropolitan) on November 4, 1960. The contract was negotiated by DWR and Metropolitan according to terms of the contracting principles for water service contracts announced by the Governor on January 20, 1960.

The Metropolitan contract became the prototype for all water contracts. By the end of 1967, 31 agencies had contracted for water. In addition, a water supply contract was executed with the City of West Covina in December 1963, but was terminated in August 1965; the city's Table A amount was transferred to Metropolitan through an amendment to the district's long-term contract with DWR. Long-term contracts with Hacienda Water District and Devil's Den Water District were also terminated when those districts transferred their Table A amounts, through contract amendments, to Tulare Lake Basin Water Storage District (1981) and Castaic Lake Water Agency (1992), respectively. Today the SWP has long-term water supply contracts with 29 agencies. Those contracts have been amended periodically to incorporate mutually agreed upon modifications.

All water contracts signed in the 1960s included an estimate of the date water would first be delivered and a schedule of the amount of water the agency could expect to be delivered annually (annual Table A amounts). That amount was designed to increase gradually until the maximum amount of annual Table A was reached. The total combined maximum annual Table A amount for all water contracting agencies was initially 4,230,000 af, assuming full development of the SWP.

The contracts were initially designed to be valid for 75 years or until all bonds sold as part of the California Water Resources Development Bond Act were repaid, whichever period was longer. As a result of amendments to contracts in the 1990s, the current combined maximum annual Table A amount totals 4,172,786 af, and the contracts are in effect for the longest of the following periods: (1) the project repayment period, which extends to 2035; (2) 75 years from the date of the contract; or (3) the period ending with the latest maturity date of any bond used to finance the construction costs of project facilities.

4. provisions to allow contractors, under certain conditions, to carry over undelivered SWP Table A water from one year for delivery in the next year; and
5. implementation of Monterey Agreement principles.

## 2007 Amendments to Long-Term Water Supply Contracts

The following water supply contract amendments were executed or became effective during 2007 for changes to Table A amounts.

### **One-Year Reduction of Table A Amounts: County of Butte**

DWR executed Amendment No. 19 to the water supply contract between County of Butte (Butte) and DWR on January 19, 2007. The amendment provides for a reduction of Butte's Table A amounts to 1,200 af for 2007 only. (SWPAO #06014)

### **Amendments to Adjust Table A Amounts**

**San Geronio Pass Water Agency.** DWR executed Amendment No. 17 to the water supply contract between San Geronio Pass Water Agency (San Geronio) and DWR on April 27, 2007. The amendment provides for a permanent increase effective January 1, 2007, of 1,150 af and permanent decreases of 5,300 af for 2008; 3,300 af for 2009; and 1,300 af for 2010 of San Geronio's Table A amounts. This had the effect of decelerating the growth of San Geronio's Table A amounts. (SWPAO #07002)

DWR executed Amendment No. 18 to the water supply contract between San Geronio and DWR on December 26, 2007. The amendment provides for a permanent increase effective January 1, 2008 of 5,300 af and permanent increases of 3,300 af for 2009, and 1,300 af for 2010 of San Geronio's Table A amounts. This had the long-term effect of restoring San Geronio's Table A deliveries to their previous amounts prior to Amendment 17 being executed. (SWPAO #07028)

### **Permanent Transfers of Table A Amounts**

Permanent transfers of Table A amounts occur in pairs; one SWP contractor's Table A amounts decrease by a designated amount, and another SWP contractor's Table A amounts increase by the same amount. The following such permanent transfers occurred in 2007.

### **From Tulare Lake Basin Water Storage District to Coachella Valley Water District and Desert Water Agency**

**Tulare Lake Basin Water Storage District.** DWR executed Amendment No. 34 to the water supply contract between Tulare Lake Basin Water Storage District (Tulare) and DWR on May 9, 2007. The amendment provides for a permanent transfer of 5,250 af to decrease Tulare's Table A amounts effective January 1, 2010. (SWPAO #07014)

**Coachella Valley Water District.** DWR executed Amendment No. 20 to the water supply contract between Coachella Valley Water District (Coachella) and DWR on May 9, 2007. The amendment provides for a permanent transfer of 5,250 af to increase Coachella's Table A amounts effective January 1, 2010. (SWPAO #07015)

**Tulare Lake Basin Water Storage District.** DWR executed Amendment No. 33 to the water supply contract between Tulare and DWR on May 9, 2007. The amendment provides for a permanent transfer of 1,750 af to decrease Tulare's Table A amounts effective January 1, 2010. (SWPAO #07012)

**Desert Water Agency.** DWR executed Amendment No. 19 to the water supply contract between Desert Water Agency (Desert) and DWR on May 9, 2007. The amendment provides for a permanent transfer of 1,750 af to increase Desert's Table A amounts effective January 1, 2010. (SWPAO #07013)

### **From Kern County Water Agency to Coachella Valley Water District and Desert Water Agency**

**Kern County Water Agency.** DWR executed Amendment No. 38 to the water supply contract between Kern County Water Agency (Kern) and DWR on September 26, 2007. The amendment provides for a permanent transfer of 12,000 af to decrease Kern's Table A amounts effective January 1, 2010. (SWPAO #07019)

**Coachella Valley Water District.** DWR executed Amendment No. 21 to the water supply contract between Coachella and DWR on September 26, 2007. The amendment provides for a permanent transfer of 12,000 af to increase Coachella's Table A amounts effective January 1, 2010. (SWPAO #07020)

**Kern County Water Agency.** DWR executed Amendment No. 37 to the water supply contract between Kern and DWR on September 26, 2007. The amendment provides for a permanent transfer of 4,000 af to decrease Kern's Table A amounts effective January 1, 2010. (SWPAO #07017)

**Desert Water Agency.** DWR executed Amendment No. 20 to the water supply contract between Desert and DWR on September 26, 2007. The amendment provides for a permanent transfer of 4,000 af to increase Desert's Table A amounts effective January 1, 2010. (SWPAO #07018)

## Monterey Amendments

The Monterey Amendments increase the reliability of existing water supplies, and increase water management flexibility, providing more tools for local water agencies to maximize use of existing facilities.

The Monterey Amendments include changes in allocation of Table A water, the transfer of Table A amounts and land, financial restructuring, and increased operational flexibility. The Monterey Amendments are discussed in detail in Chapter 1, Summary of Significant Events, of Bulletin 132-95, available online at [http://www.water.ca.gov/swpao/docs/bulletin/95/chapters\\_frameset95.html](http://www.water.ca.gov/swpao/docs/bulletin/95/chapters_frameset95.html).

Plumas County Flood Control and Water Conservation District (Plumas) and Empire-West Side Irrigation District (Empire) remain the only long-term SWP water contractors who have not signed the Monterey Amendments.

In accordance with the terms of the May 5, 2003, Monterey Settlement Agreement, the SWP continues to operate pursuant to the Monterey Amendments, while the new environmental impact report (EIR) is being prepared. The draft EIR was released in October 2007 and is available online at [http://www.water.ca.gov/environmentalservices/monterey\\_plus.cfm](http://www.water.ca.gov/environmentalservices/monterey_plus.cfm). The final EIR is expected to be released in early 2010. The settlement agreement is discussed in detail in Chapter 9, Water Contracts and Deliveries, of Bulletin 132-04 (available online at <http://www.water.ca.gov/swpao/docs/bulletin/04/Bulletin132-04.pdf>).

## Miscellaneous Agreements with Long-Term SWP Water Contractors

### 2007 Water Conveyance and Exchange Agreements

Water conveyance and exchange agreements that were executed or pending execution with long-term SWP water contractors during 2007 are described below.

#### Castaic Lake Water Agency

An agreement pending execution among DWR, Castaic Lake Water Agency (Castaic Lake), and Kern provides for the long-term annual conveyance of up to 11,000 af of nonproject Kern River water from Buena Vista Water Storage District (Buena Vista), a member unit of Kern, to Castaic Lake. The Kern River water will be provided to Castaic Lake either by a change in the point of delivery (POD) of a portion of Kern's annual Table A water in exchange for a like amount of Buena Vista's water or by direct pump-in to the California Aqueduct and conveyance under Article 55 of Castaic's long-term water supply contract. A total of 11,000 af was delivered under this agreement during 2007. (SWPAO #07008)

### **County of Butte**

A letter agreement dated December 17, 2007 between DWR and County of Butte (Butte) provides for a one-time approval of an advance delivery of 255 af of Butte's 2008 Table A allocation to meet Butte's 2007 water supply needs. Butte County received 236 af under this agreement, which DWR will deduct from Butte's 2008 Table A water allocation. (SWPAO #07032)

### **Crestline-Lake Arrowhead Water Agency**

A long-term POD agreement pending execution among DWR, Crestline-Lake Arrowhead Water Agency (Crestline), and San Bernardino Valley Municipal Water District (San Bernardino) will provide for an emergency water supply totaling 7,600 af to Lake Arrowhead Water Community Services District effective January 1, 2007 through December 31, 2020, or until all water has been delivered pursuant to this agreement. A total of 710 af was delivered to Crestline in 2007. (SWPAO #07025)

### **Dudley Ridge Water District**

An agreement pending execution among DWR, Dudley Ridge Water District (Dudley Ridge), and Kern will provide for the transfer of up to 1,000 af of Dudley Ridge's 2007 Table A water to Kern on behalf of a landowner who farms in both the Dudley Ridge and Kern service areas. During 2007, 1,000 af was delivered under this agreement. (SWPAO #07034)

### **Empire-West Side Irrigation District**

A contract dated April 30, 2007, between DWR and Empire provides for the delivery of unscheduled water to Empire in 2007 at times when SWP water is not needed for fulfilling Table A deliveries or for meeting project operational commitments. During 2007, 1,172 af of unscheduled water was delivered to Empire. (SWPAO #07009)

### **Kern County Water Agency**

A letter agreement executed on April 26, 2007, between DWR and Kern provides for the transfer and future return of up to 50,000 af of Westlands Water District (Westlands) Central Valley Project (CVP) water to Kern. The Bureau of Reclamation (Reclamation) provided Westlands' 2006–2007 CVP water in O'Neill Forebay, and DWR conveyed the water, under Article 55 of Kern's long-term water supply contract, to Semitropic Water Storage District (Semitropic), a member unit of Kern. Water will be returned to Westlands either by pumping recovered groundwater into the California Aqueduct and delivery of a like amount by DWR to CVP in O'Neill Forebay, or by delivery of Kern's Table A water in a like amount to CVP in O'Neill Forebay. During 2007, 8,867 af was delivered to Kern pursuant to this agreement. (SWPAO #06013)

A letter agreement, pending execution between DWR and Kern, will provide for the delivery of up to 1,000 af of the City of Tracy's (Tracy) 2006–2007 CVP water to Kern for Semitropic to use as in lieu or for direct recharge of the local groundwater basin. In exchange, the agreement states that 100 af will be returned to Tracy in 2007 and a total of 800 af in future years. In 2007, 1,000 af of Tracy's CVP water was delivered to Semitropic and 100 af was returned to Tracy. (SWPAO #07011)

A letter agreement, pending execution between DWR and Kern, will provide for the delivery of up to 53,300 af of 2007 CVP water to Kern from Kern-Tulare Water District (Kern-Tulare) and Rag Gulch Water District (Rag Gulch), both Cross Valley Canal (CVC) contractors, in exchange for a like amount of Kern's Table A water. The CVP water will be delivered pursuant to Article 55 of Kern's long-term water supply contract. The agreement would be effective from March 1, 2007, through February 29, 2008. During 2007, 15,429 af of 2007 CVP water was delivered to Kern. (SWPAO #07016)

A change in POD agreement is pending execution among DWR, Kern, and Westlands for up to 6,214 af of Kern's 2007 Table A water. Kern's water will be delivered to the Kings County portion of Westlands' service area, which is within the SWP place of use. This agreement will allow for conveyance of nonproject water to Westlands from Nickel Family, LLC, by exchanging that water for a portion of Kern's 2007 Table A water. The agreement would be effective from July 15, 2007, through December 31, 2008. A total of 6,214 af was delivered to Westlands during 2007. (SWPAO #07023)

A change in POD agreement is pending execution among DWR, Kern, and Westlands for up to 10,000 af of Kern's 2007 Table A. Kern's water will be delivered to the Kings County portion of Westlands' service area, which is within the SWP place of use. This agreement will allow Westlands to acquire water stored in the Kern Water Bank (KWB) by exchanging that water for a portion of Kern's 2007 Table A water. The agreement would be effective from July 15, 2007, until all water has been returned pursuant to the agreement. During 2007, 10,000 af was delivered to Westlands. (SWPAO #07026)

A letter agreement, pending execution between DWR and Kern, will provide for the delivery of up to 10,000 af of Kern's 2007 Table A water in O'Neill Forebay for use at the Kern National Wildlife Refuge on behalf of Reclamation. This action will facilitate the return of 11,111 af of Kern-Tulare's (a CVP contractor) Friant-Kern water acquired by Reclamation. This agreement would be effective from January 1, 2007, through December 31, 2007. A total of 10,000 af was made available to Reclamation during 2007. (SWPAO #07033)

### **County of Kings**

A change in POD agreement, pending execution among DWR, County of Kings (Kings), and Westlands, provides for Kings'

approved SWP water supplies to be delivered to specified Westlands turnouts in the California Aqueduct. This agreement defines the Westlands turnouts to be used during the term of the agreement, January 1, 2007, through December 31, 2035. Kings requested the water for use on Westlands' agricultural lands within Kings' service area, and during 2007 DWR delivered 300 af of Kings' 2007 Table A water and 286 af of Article 21 water. (SWPAO #07010)

### **Littlerock Creek Irrigation District**

A letter agreement executed on December 31, 2007, among DWR, Littlerock Creek Irrigation District (Littlerock) and Antelope Valley-East Kern Water Agency (AVEK) will provide for the exchange of up to 1,380 af of Littlerock's 2007 Table A water with AVEK. AVEK will return an equal amount of its allocation of Table A water by December 31, 2017. DWR delivered 1,380 af of Littlerock's 2007 Table A water to AVEK's service area. (SWPAO #07031)

### **Palmdale Water District**

An agreement pending execution among DWR, Kern, West Kern Water District (West Kern) a member unit of Kern, and Palmdale Water District (Palmdale) will provide for the delivery of 5,000 af of West Kern's portion of Kern's 2007 Table A water to Palmdale, effective September 1, 2007. By December 31, 2017, Palmdale will provide for the return of 10,000 af of Palmdale's Table A water to Kern. This 2-for-1 exchange was necessary in order for Palmdale to acquire an additional water supply for 2007. Kern provided 4,926 af for DWR delivery during 2007. (SWPAO #07029)

### **Tulare Lake Basin Water Storage District**

A letter agreement dated May 4, 2007 between DWR and Tulare approved the transfer of up to 5,000 af of Tulare's 2007 Table A water to Westlands. The transfer was made on behalf of two landowners, Hansen Ranches for up to 4,000 af, and Newton

Farms for up to 1,000 af, both of which farm in Tulare's and Westlands' service areas. DWR petitioned the State Water Resources Control Board (SWRCB) for a temporary change in place of use and received approval on May 7, 2007. During 2007, 4,340 af of Tulare's Table A water was delivered to Westlands. (SWPAO #07003)

A letter agreement dated April 27, 2007, between DWR and Tulare approved the transfer of up to 6,000 af of Tulare's 2007 Table A water to Westlands on behalf of Westlake Farms Inc., which farms in both Tulare's and Westlands' service areas. During 2007, 1,805 af was delivered to Westlands for use on lands within the SWP place of use, Kings County portion of Westlands' service area. (SWPAO #07004)

A letter dated January 25, 2007, from DWR approved a temporary change in the delivery of Tulare's SWP water supplies through Dudley Ridge's turnout and for subsequent delivery into Tulare's service area effective December 19, 2006, through December 31, 2007. This approval facilitates the use of two adjacent turnouts during capacity restrictions in Tulare's turnout. During 2007, DWR delivered 454 af of Tulare's Article 21 water and 305 af of Article 56(c) water through Dudley Ridge's Turnout 2. (SWPAO #07006)

### ***Oak Flat Water District***

A letter agreement, pending execution between DWR and Oak Flat Water District (Oak Flat), provides for a one-time approval of an advance delivery of Oak Flat's 2008 Table A allocation to meet Oak Flat's 2007 water supply needs. Oak Flat received 10 af in 2007 and DWR will deduct 10 af from Oak Flat's 2008 Table A water allocation. (SWPAO #07036)

### ***Santa Clara Valley Water District***

A letter agreement dated August 16, 2007 approved the conveyance of up to 3,100 af

of Brown's Valley Irrigation District non-Project water under Article 55 of Santa Clara's Water Supply Contract. During 2007, 3,100 af was delivered under this agreement. (SWPAO #07021)

## **Water Conveyance and Exchange Agreements Prior to 2007**

Water delivered during 2007 pursuant to agreements with SWP water contractors that were executed prior to 2007, is described below.

### ***Castaic Lake Water Agency***

By a letter dated June 2, 1994, DWR recognized the long-term agreement "Wheeling of SWP Water and other Allocated Water to Castaic Lake Water Agency" between Castaic Lake and Metropolitan Water District of Southern California (Metropolitan) for the conveyance of Castaic Lake's SWP water supplies through Metropolitan's Foothill Feeder. Metropolitan will convey Castaic Lake's water to the Rio Vista Water Treatment Plant in Castaic Lake's service area. During 2007, DWR delivered to Metropolitan's turnout facility 20,336 af of Castaic Lake's approved SWP water supplies (790 af of Article 56 water, and 19,546 af of Table A water). (SWPAO #94001)

### ***County of Kings***

A long-term change in POD agreement, executed March 10, 2006, among DWR, Kings, and Tulare will provide for the delivery of up to 200 af of Kings' annual Table A water and other SWP water supplies to Westlands' service area. The water is conveyed to GWF Energy, LLC, for use within the SWP place of use, Kings County service area. During 2007, 2 af was delivered to Westlands turnouts. (SWPAO #02031)

A change in POD agreement, executed March 24, 2004, among DWR, Kings, and Westlands provides for the delivery of up to 5,000 af of Kings' annual Table A water

through Westlands turnouts for use at Lemoore Naval Air Station. The agreement is effective from January 1, 2004, through December 31, 2035. During 2007, DWR delivered 2,531 af of Kings' Table A water to Westlands turnouts. (SWPAO #04005)

### ***Dudley Ridge Water District***

A long-term letter agreement dated November 19, 2003, among DWR, Dudley Ridge, and San Gabriel Valley Municipal Water District (San Gabriel) provides for delivery to San Gabriel of up to 11,458 af of Dudley Ridge's 2003 Table A amounts. San Gabriel will return its Table A water to Dudley Ridge during the term of the agreement through December 31, 2013. During 2007, San Gabriel returned 5,857 af of its Table A water to Dudley Ridge. (SWPAO #03055)

A long-term letter agreement dated March 13, 2005, among DWR, Dudley Ridge, and Kern provides for delivery to Kern of up to 12,000 af of Dudley Ridge's 2005 Table A water. Kern will return a portion of its Table A water, equal to two-thirds (66.7 percent) of Dudley Ridge's water delivered to Kern in 2005, during the term of the agreement through December 31, 2018. Kern returned 2,000 af of its Table A water to Dudley Ridge in 2007. (SWPAO #05015)

### ***Kern County Water Agency***

A POD agreement executed on June 8, 2000, between DWR and Kern provides approval for the delivery to Western Hills Water District (Western Hills) a portion of Kern's annual Table A water. In exchange, Kern will take a like amount of banked local water from the Pioneer Groundwater Bank. SWRCB approved Western Hills' service area to be included within the authorized SWP place of use on April 21, 2000. During 2007, 1,031 af of Kern's Table A water was delivered to Western Hills. (SWPAO #01001)

A long-term letter agreement dated July 19, 2006 provides for the delivery of up to 25,000 af of Westlands' CVP water to Kern for storage in Semitropic effective November 1, 2005, through April 15, 2006. Kern will provide return water in future years through December 31, 2035, or when all stored water has been returned to Westlands. By a letter dated October 11, 2007, from DWR, and with SWRCB approval, Kern provided 4,000 af of Westlands' water to the Fresno County portion of Westlands' service area during 2007. (SWPAO #05020)

### ***Mojave Water Agency***

A change in POD agreement executed November 13, 1997, among AVEK, Mojave Water Agency (Mojave), and DWR, and effective through December 31, 2019, allows for delivery of up to 2,250 af of Mojave's annual Table A amount to AVEK. Mojave does not have conveyance facilities to provide service to a solar energy generating station located within its service area. AVEK does have conveyance capability and has agreed to provide water service on Mojave's behalf. During 2007, DWR delivered 1,176 af of Mojave's SWP water supplies through AVEK's turnout, of which 1,140 af was 2007 Table A and 36 af was 2006 Article 56(c). (SWPAO #97003)

### ***Napa County Flood Control and Water Conservation District***

A change in POD agreement executed December 26, 2001, among DWR, Napa County Flood Control and Water Conservation District (Napa), and Solano County Water Agency (Solano) approved the delivery of up to 628 af of Napa's annual Table A water to the City of Vallejo Water Treatment Plant in Solano's service area of the North Bay Aqueduct (NBA). This water is further conveyed to the City of American Canyon, a member agency of Napa. During 2007, 180 af of Napa's water was delivered to Solano—175 af was Table A and 5 af was 2006 Article 56(c). (SWPAO #00029)

### **San Bernardino Valley Municipal Water District**

San Bernardino and Metropolitan entered into Attachment 2 *Coordinated Use Agreement for Conveyance Facilities and State Water Project Water Supplies* on

May 14, 2001. By a letter dated February 27, 2002, DWR acknowledged the agreement and the coordinated use of local facilities currently existing within San Bernardino's jurisdictional boundaries. The coordinated use provides for delivery of San Bernardino's SWP water to Metropolitan's facilities within San Bernardino's service area. This action is permitted under Article 10 of the long-term water supply contract. During 2007, 30,000 af of San Bernardino's Table A water was delivered to Metropolitan. (SWPAO #02035)

### **Santa Barbara County Flood Control and Water Conservation District**

A long-term letter agreement dated September 13, 2002, among DWR, Santa Barbara County Flood Control and Water Conservation District (Santa Barbara), and Dudley Ridge approved the exchange of up to 745 af of Santa Barbara's 2002 Table A water delivered to Dudley Ridge during 2002. Dudley Ridge will provide its future water supplies by December 31, 2012, to return water to Santa Barbara. During 2004, Dudley Ridge provided 225 af of its Table A water to Santa Barbara, and during 2007 the agreement was completed with a final return delivery of 520 af. (SWPAO #02013)

### **Solano County Water Agency**

A settlement agreement was executed May 19, 2003, among DWR, Solano, and the cities of Fairfield, Vacaville, and Benicia. Concurrently, a conveyance agreement was executed between DWR and Solano. Together, these agreements approved the delivery of up to 31,620 af annually of settlement water to Solano for delivery to the three cities to help meet their current and future municipal and industrial water needs

through the NBA. During 2007, 10,568 af of settlement water was delivered to the three cities via the NBA. (SWPAO #03017)

## **Turnout Agreements**

### **Kern County Water Agency**

On July 2, 2007, DWR executed an agreement with Kern and Tejon-Castac Water District (Tejon-Castac) for operation and maintenance of the Wheeler Ridge-Maricopa Turnout No. 12 located at Milepost 285.01 of the California Aqueduct. The agreement transfers all interests, rights, and responsibilities of the turnout from Wheeler Ridge-Maricopa Water Storage District (Wheeler Ridge-Maricopa) to Tejon-Castac. The turnout has a maximum design capacity of 65 cubic feet per second (cfs).

### **Kern County Water Agency**

On August 29, 2007, DWR executed an agreement with Kern and Semitropic for construction, operation, and maintenance of the Semitropic No. 3 Turnout, a new turn-in/turnout facility located at Milepost 206.99 of the California Aqueduct. In addition to water supply, the facility will increase the rate at which water that is stored in the Semitropic Groundwater Bank can be recovered by the water agencies that have placed the water into storage. The design capacity of the facility is 620 cfs.

### **Plumas County Flood Control and Water Conservation District**

On December 19, 2007, DWR executed an agreement with Plumas for operation of the Grizzly Ranch Turnout to deliver SWP water to the Grizzly Ranch Community Services District. The turnout is located on Grizzly Creek, approximately 4.7 miles downstream from the dam at Lake Davis (an SWP facility) with a design capacity of 1 cfs.



## Agreements and Activities Related to the Monterey Amendments

### Turn-Back Water Pool Program

Pursuant to Article 56(d) of the Monterey Amendments, the twelfth year of the Turn-Back Water Pool Program was initiated by Notice to State Water Project Contractors No. 07-02, dated February 9, 2007. All SWP water contractors who signed the Monterey Amendments were permitted to participate in the program. The program allowed SWP water contractors to offer a portion of their approved 2007 Table A water for sale in a turn-back pool for use by interested SWP water contractors. Based on Table A supply and demand, turn-back pool water was allocated among the purchasing contractors. In 2007, 16,380 af was purchased under the Turn-Back Water Pool Program.

Initial transactions for Pool A and Pool B of the Turn-Back Water Pool Program occurred in February and March 2007, respectively. The program was then extended to June 1 to allow for changes in the percentages of Table A allocations between April 1 and June 1. Only SWP water contractors who were already committed to purchase water through Pool B were allowed to continue with the program until June. Turn-back pool water sold for \$12.74 per af (50 percent of the Delta Water Rate) through Pool A, and for \$6.37 per af (25 percent of the Delta Water Rate) through Pool B. All money collected through the Turn-Back Water Pool Program was paid to the selling SWP water contractors. The 2007 Turn-Back Water Pool Program closed on June 1, 2007. Notices to State Water Project Contractors describing the Turn-Back Water Pool Program are available online at <http://www.water.ca.gov/swpao/notices.cfm>.

Table 9-1 lists SWP water contractors who participated in Pool A and Pool B of the Turn-Back Water Pool Program in 2007.

**Table 9-1 2007 Turn-Back Water Pool Program (af)**

Contractor	Sold	Purchased
<b>Pool A</b>		
San Gabriel	7,280	
San Luis Obispo	100	
Ventura	9,000	
Alameda County		197
Alameda-Zone 7		378
Coachella		568
Desert		234
Dudley Ridge		269
Kern		4,683
Kings		43
Metropolitan		8,962
Oak Flat		27
Palmdale		100
Santa Clara		469
Tulare		450
<b>Total</b>	<b>16,380</b>	<b>16,380</b>
<b>Pool B</b>		
<b>Total</b>	<b>0</b>	<b>0</b>

### Storage of Water Outside Service Area

Pursuant to Article 56(c) of the Monterey Amendments, SWP water contractors have agreements with DWR to deliver SWP water outside their service areas for storage and later use within their service areas. The following agreements include provisions for the conveyance and points of delivery of such water.

#### Alameda County Flood Control and Water Conservation District, Zone 7

A long-term change in POD agreement pending among DWR, Alameda County Flood Control and Water Conservation District, Zone 7 (Alameda-Zone 7), and Kern, provides for the delivery of a portion of Alameda-Zone 7's approved SWP water supplies for storage in Semitropic, and for the return of such water by future exchange of a like amount of Kern's Table A water. All

return water is to be delivered to Alameda-Zone 7 by December 31, 2035. During 2007, a total of 717 af of Alameda-Zone 7's water supply was delivered to Semitropic of which 250 af was 2006 Article 56(c) and 467 af was Article 21. No water was recovered in 2007 under this agreement. (SWPAO #04017)

A long-term change in POD agreement pending among DWR, Alameda-Zone 7, and Kern will provide for delivery of a portion of Alameda-Zone 7's approved SWP water supplies for storage in Cawelo Water District, a member unit of Kern. Alameda-Zone 7 would recover one-half of its stored water in future years by the return of Cawelo's portion of Kern's Table A water or by direct pumping from the groundwater bank into the California Aqueduct. All return water is to be delivered to Alameda-Zone 7 by December 31, 2035. During 2007, no water was delivered or recovered under this agreement. (SWPAO #06010)

### ***Alameda County Water District***

A POD agreement dated October 28, 1996, among DWR, Alameda County Water District (Alameda County), and Kern provides for the conveyance of a portion of Alameda County's 1996 Table A water to Semitropic. Kern's Table A water will be exchanged for recovery of Alameda County's stored water supplies or by direct pump-in to the California Aqueduct in future years through December 31, 2035. During 2007, 5,000 af was recovered by Alameda County through exchange of Kern's Table A from Semitropic under this agreement. (SWPAO #96018)

A change in POD agreement pending execution among DWR, Alameda County, and Kern, will provide for the delivery of a portion of Alameda County's 2007 approved SWP water supplies for storage in, and later recovery from, Semitropic. DWR delivered a total of 1,029 af of Alameda County's 2007 SWP water supplies— 451 af was Article 21 water and 578 af was Article 56(c). No water

was recovered from storage in 2007 under this agreement. (SWPAO #07005)

### ***Castaic Lake Water Agency***

A long-term change in POD agreement, executed September 25, 2006, among DWR, Castaic Lake, and Kern, provides for the delivery of a portion of Castaic Lake's approved 2005 and future SWP water supplies for storage in, and later recovery from, Rosedale-Rio Bravo Water Storage District (Rosedale-Rio), a member unit of Kern. During 2007, DWR delivered 8,200 af of Castaic Lake's approved 2007 Table A water to Kern for subsequent delivery to Rosedale-Rio. (SWPAO #05016)

### ***Dudley Ridge Water District***

A letter agreement dated October 22, 1997, among DWR, Dudley Ridge, and Kern allowed for the transfer and future return of Dudley Ridge's 1997 SWP water supplies to Kern for storage in the KWB, within Kern's service area, on an acre-foot for acre-foot basis. During 2007, Kern returned 462 af to Dudley Ridge to complete the agreement. (SWPAO #97021)

A letter agreement dated February 26, 1998 among DWR, Dudley Ridge, and Kern allowed for the transfer and future return of Dudley Ridge's 1998 SWP water supplies to Kern for storage in the KWB within Kern's service area on an acre-foot for acre-foot basis. During 2007, Kern returned 5,278 af to Dudley Ridge to complete the agreement. (SWPAO #98003)

A letter agreement, executed October 2, 2006, among DWR, Dudley Ridge, and San Gabriel provided for delivery of a portion of Dudley Ridge's 2005 and 2006 approved SWP water supplies to San Gabriel's service area for groundwater recharge. In future years, through December 31, 2016, San Gabriel will return a like amount of its Table A water to Dudley Ridge. During 2007, 119 af of San

Gabriel's 2007 Table A water was returned to Dudley Ridge. (SWPAO #05017)

A change in POD agreement pending execution among DWR, Dudley Ridge, and Kern, will provide for the delivery of a portion of Dudley Ridge's 2007 approved SWP water supplies for storage in and later recovery from the KWB. DWR delivered 2,161 af of Dudley Ridge's SWP water supplies allocated as Article 21 water during 2007. No water was recovered from storage in 2007 under this agreement. (SWPAO #07001)

### **Metropolitan Water District of Southern California**

A long-term agreement executed on August 21, 1995, among DWR, Metropolitan, and Kern provides for the delivery of a portion of Metropolitan's SWP water supplies for storage in and later recovery from Semitropic. The agreement is effective until November 4, 2035. Recovery of Metropolitan's water is either by direct pump-in to the California Aqueduct or by exchange of Kern's SWP allocated water. During 2007, no water was stored under this agreement; however, 93,986 af was recovered for delivery to Metropolitan's service area. (SWPAO #95010)

A long-term POD agreement, executed March 18, 2004, among DWR, Metropolitan, and Kern, provides for the delivery of a portion of Metropolitan's future SWP water supplies for storage in and later recovery from groundwater basins within Arvin-Edison Water Storage District (Arvin-Edison). A letter agreement dated December 29, 1997, among DWR, Kern, Metropolitan, and Arvin-Edison, along with subsequent extensions to that agreement, provided approval for Metropolitan's water to be delivered for storage to Arvin-Edison. This 2004 agreement recognizes water delivered for storage, in multiple prior years starting in 1997, and for the future return of that

water. The return water is to be delivered to Metropolitan from Arvin-Edison by pump-in or by exchange of Metropolitan's water for a like amount of Kern's Table A water or other water supplies. During 2007, 1,881 af of Metropolitan's Article 21 water was delivered to Arvin-Edison for storage pursuant to SWPAO agreement #01013. A total of 22,532 af was recovered for delivery to Metropolitan; 7,586 af was recovered to complete a prior year agreement, SWPAO #99009, and 16,639 af was recovered under SWPAO #01013. (SWPAO #99009 and #01013)

A long-term POD agreement executed August 30, 2004, among DWR, Metropolitan, and Kern, provides for the delivery of a portion of Metropolitan's approved SWP supplies for storage in and later recovery from the groundwater basin underlying Kern Delta Water District (Kern Delta), a member unit of Kern. During 2007, no water was delivered or recovered from storage in Kern Delta. (SWPAO #03019)

A POD agreement is pending execution among DWR, Metropolitan, and Mojave to provide for the delivery of up to 75,000 af of Metropolitan's 2003, 2004, and 2005 approved SWP water supplies for storage within the Mojave service area. The water is to be returned to Metropolitan by exchange of Mojave's Table A water by January 15, 2010. During 2007, 26,000 af was returned to Metropolitan. (SWPAO #03057)

### **Santa Clara Valley Water District**

A POD agreement dated September 19, 1996, among DWR, Santa Clara Valley Water District (Santa Clara), and Kern provides for the conveyance of a portion of Santa Clara's 1996 Table A water to Semitropic. Kern's Table A water will be exchanged for recovery of Santa Clara's stored water supplies or by direct pump-in to the California Aqueduct in future years through December 31, 2035. During 2007, 10,500 af was recovered by

Santa Clara through exchange of Kern's Table A from Semitropic to complete this agreement. (SWPAO #96012)

A POD agreement dated November 10, 1997, among DWR, Santa Clara, and Kern will provide for the conveyance of a portion of Santa Clara's 1997 Table A water to Semitropic. Kern's Table A water will be exchanged for recovery of Santa Clara's stored water supplies or by direct pump-in to the California Aqueduct in future years through December 31, 2035. During 2007, 9,500 af was recovered by Santa Clara through exchange of Kern's Table A from Semitropic under this agreement. (SWPAO #97020)

A POD agreement, pending execution among DWR, Santa Clara, and Kern, will provide for the delivery of a portion of Santa Clara's approved 2007 SWP water supplies for storage in and later recovery from Semitropic. During 2007, DWR delivered a total of 2,342 af of Article 21 and 1,350 af of 2006 Article 56(c) to Semitropic. (SWPAO #06011)

A letter agreement pending execution among DWR, Santa Clara, and Kern will provide for the conveyance of a portion of Santa Clara's CVP water to Semitropic pursuant to Article 55 of Santa Clara's long-term water supply contract. Kern's Table A water will be exchanged for recovery of Santa Clara's stored CVP supplies in future years through December 31, 2035. This agreement acknowledges DWR delivery of CVP water in 2005 and 2006. During 2007, no water was recovered by Santa Clara through exchange of Kern's Table A from Semitropic under this agreement. (SWPAO #06012)

## Article 21 Water Program

Pursuant to the Monterey Amendments, Article 21 water replaces unscheduled, surplus, wet weather, and Article 12(d) water. The Article 21 Water Program allows

an SWP water contractor to take delivery of water over the approved and scheduled Table A amounts for the current year. Article 21 water is available for delivery on a short-term basis as determined by DWR when water is still available after operational requirements for SWP water deliveries, water quality, and Delta requirements are met.

Conditions for the Article 21 Water Program for 2007 are described in the February 8, 2007, Notice to State Water Project Contractors No. 07-01, available online at <http://www.water.ca.gov/swpao/notices.cfm>. Fourteen participants signed the notice, which indicated their acceptance of the criteria, procedures, and charges for the program. They collectively received 308,801 af of Article 21 water (Table 9-2).

During the Article 21 Water Program period, unscheduled water was also made available to Empire pursuant to its long-term water supply contract. Empire received 1,172 af of unscheduled water in 2007 for agricultural purposes.

**Table 9-2 2007 Article 21 Water Deliveries (af)**

Contractor	Amount
Alameda County	550
Alameda-Zone 7	912
Dudley Ridge	8,953
Kern	99,861
Kings	474
Metropolitan	166,517
Napa	3,597
Oak Flat	41
Palmdale	843
San Luis Obispo	24
Santa Barbara	1,070
Santa Clara	4,840
Solano	8,217
Tulare	12,902
<i>Subtotal</i>	<i>308,801</i>
Empire <sup>a</sup>	1,172
<b>Total</b>	<b>309,973</b>

<sup>a</sup>Unscheduled agricultural water.

### Flexible Storage Program

Pursuant to Article 54 of the Monterey Amendments, the flexible storage program provides SWP water contractors participating in the repayment of the capital costs of Castaic Lake and Lake Perris the option to withdraw water in excess of approved deliveries. The program objective is to provide additional flexibility and water management benefits to local participating agencies.

Available “flexible storage” is approximately 50 percent of active storage, providing for 160,000 af at Castaic Lake and 65,000 af at Lake Perris. Participating SWP water contractors participating in the Castaic Lake flexible storage program include Metropolitan, Ventura County Watershed Protection District (Ventura), and Castaic

Lake. Each can withdraw a maximum of 153,940 af, 1,377 af, and 4,683 af, respectively. At Lake Perris, since 2004, Metropolitan, Coachella, and Desert have participated in the repayment of the capital costs; but through agreement, Metropolitan is the only SWP water contractor that can withdraw water, and it may withdraw up to 65,000 af. Any participating SWP water contractor is given 5 years to replace the water with Table A amounts, purchased water, exchange water, or local water.

Metropolitan participated in the flexible storage program in 2007. In 2007, it borrowed 99,367 af from Castaic Lake and replaced 84,017 af, leaving a negative balance of 15,350 af. They had a zero balance in Lake Perris at the end of 2003. In 2007, it borrowed 15,837 af, leaving a balance of zero.

### Extended Carryover Program

Pursuant to Article 56 of the Monterey Amendments, SWP water contractors can elect to store project water outside of their service areas and carry it over to the following year for use within their service areas. Qualified contractors can request Table A water be carried over for delivery in the following year to the extent that such deliveries do not adversely affect current or future project operations. Factors that influence how much extended carryover water can be delivered include operational constraints of project facilities, filling of SWP conservation storage facilities, flood control releases, and water quality restrictions. If storage requests exceed the available storage capacity, the amount available is allocated among the SWP water contractors requesting storage in proportion to their annual Table A water for that year. Fifteen SWP water contractors took delivery of 93,942 af of approved 2006 Table A water carried over into 2007, as extended carryover.

## Kern River Intertie

DWR may accept floodwaters into the California Aqueduct under the “Agreement Among the State of California, Kern County Water Agency, and the Kern River Interests for Diversions of Floodwaters Through the Kern River-California Aqueduct Intertie,” dated November 18, 1975.

The intertie was authorized by the U.S. Army Corps of Engineers (Corps) as a Small Flood Control Project under the Flood Control Act of 1948, and construction was completed by the Corps in 1977.

Floodwaters from the Kern River, and other water that flows into the Kern River downstream from Lake Isabella, which are determined to be in excess of the needs of the Kern River Interests (Buena Vista Water Storage District, North Kern Water Storage District, Tulare Lake Basin Water Storage District, and Hacienda Water District) are diverted into the California Aqueduct under this agreement to alleviate flooding in Kern and Tulare counties. No flood flows were introduced into the California Aqueduct during 2007.

## Environmental Water Account

The Environmental Water Account (EWA) is a cooperatively managed program intended to provide beneficial environmental changes to protect the fish of the Bay-Delta Estuary through increased operational flexibility of the SWP and CVP Delta export pumps without uncompensated water supply impacts on the SWP and CVP contractors. Three management agencies: the National Marine Fisheries Service (NOAA Fisheries), U.S. Fish and Wildlife Service (USFWS), and the Department of Fish and Game (DFG); and two project agencies: Reclamation and DWR, are responsible for implementing the EWA.

The EWA provides fish protection by curtailing project water exports from the Sacramento-San Joaquin Delta in the winter and spring and replacing it at a later date, usually in the summer of the same calendar year. The EWA acquires water from willing sellers to replace Delta exports foregone during pumping curtailments and repays that water to the SWP and CVP to assure no interruptions in scheduled deliveries. EWA assets consist of “operational assets,” which are acquired through changes in operations as defined in the August 28, 2000, CALFED record of decision (ROD); “purchased assets,” water purchased from willing water sellers; “source shifting,” which involves deferral of scheduled delivery of water to willing participants who are compensated for the risk involved; and other non-water assets, including 500 cfs of dedicated pumping capacity at Banks Pumping Plant from July 1 through September 30.

In 2007, the EWA's seventh operational year, Delta exports were periodically curtailed at the SWP and the CVP export facilities between January and June. These actions resulted in EWA export reductions of about 408,050 af by the SWP (January—96,598 af; February—68,300 af; March—75,200 af; April—21,900 af; May—73,401 af; and June—72,651 af) and 93,466 af by the CVP (May—39,393 af and June—54,073 af).

During water year 2007, DWR and Reclamation obtained 451,472 af of assets for the EWA, which included upstream of Delta water purchases of 113,538 af from Yuba County Water Agency (Yuba) and Merced Irrigation District (MID) after carriage and conveyance losses, south of Delta water purchases of 125,000 af from Kern, and 212,933 af from Operational Assets (see explanation in “Operational Assets” later in the chapter). The upstream of Delta water purchases consisted of a Reclamation purchase of 25,000 af from MID and DWR purchases of 125,000 af of water from Yuba. The 125,000 af of Yuba assets resulted from

two DWR purchases of water from Yuba: 62,000 af in 2006 that could not be delivered until 2007 due to excess conditions in the Delta in 2006, and 63,000 af purchased in 2007.

All EWA asset acquisitions in 2007 were covered by the EWA environmental impact statement (EIS)/(EIR) in compliance with the National Environmental Policy Act (NEPA) and the California Environmental Quality Act (CEQA). Source shifting to defer water deliveries was not required because the water level of San Luis Reservoir did not require such action. The EWA had no carryover debt at the beginning of January 2007. EWA's debt increased to 50,042 af by the end of December 2007.

The EWA Operating Principles Agreement between DWR, Reclamation, U.S. Fish and Wildlife Service (USFWS), National Marine Fisheries Service (NOAA Fisheries), and the Department of Fish and Game (DFG) expired on December 31, 2007, marking the end of the multi-agency operations of the EWA. Congressional authorization and limited federal funding of the EWA will continue into 2008.

## Technical Services for Evaluation of the Environmental Water Account

### Department of Fish and Game

DWR and DFG executed Amendment No. 1 to Interagency Agreement No. 4600004351 (SWPAO #06702) on May 29, 2007, to extend the contract term by 2 years from June 30, 2007, to June 30, 2009, and to increase the maximum amount payable by DWR for DFG's services to the EWA for fiscal year (FY) 2008 and FY 2009 by \$298,820 from \$281,089 to \$579,909. Under this amendment, DFG will continue to provide technical services to DWR for development and refinement of the EWA, planning and management, and to conduct evaluations of the effectiveness of the EWA in protecting Delta fisheries and

maintaining water supply reliability for SWP and CVP water users.

## Purchased Assets

The following SWP water contractors and other willing sellers participated in the EWA program in 2007. The purchased asset water amounts described herein represent the total amounts of water acquired for the EWA from various sources. These amounts have not been adjusted to reflect Delta carriage and conveyance losses.

### Kern County Water Agency

DWR and Kern completed their third and final year of the multiyear agreement in 2007 (SWPAO #05705) for support of the EWA by exchanging 125,000 af of previously stored water in the KWB for the same amount of Kern's Table A water.

DWR and Kern executed Amendment No. 1 to *Agreement for the Transfer of Water from Kern County Water Agency to the Department of Water Resources of the State of California on Behalf of the Environmental Water Account for the Years 2005 through 2007* (SWPAO #05705-A1) on December 31, 2007 to extend the transfer of water to DWR for support of the EWA through December 31, 2008.

### Merced Irrigation District

Reclamation purchased 25,000 af of water for the EWA in 2007 that was transferred in October and November to provide added instream fishery benefits. The transfer was charged a 10 percent conveyance loss.

### Metropolitan Water District of Southern California

DWR and Metropolitan completed their third and final year of the multiyear agreement in 2007 (SWPAO #05701) for delivery of up to 100,000 af of Metropolitan Exchange Water to DWR for EWA's use in 2005. An equal amount of EWA Exchange Water will

be returned in years in which DWR's final allocation of SWP water to State Water Contractors is greater than 60 percent of Table A amounts. DWR could not return the 50,000 af of Metropolitan Exchange Water by the end of the contract term due to wet year hydrology conditions.

DWR and Metropolitan executed Amendment No. 1 to *Agreement between the Department of Water Resources of the State of California and Metropolitan Water District of Southern California for an Equal Exchange of Water in Support of the Environmental Water Account Program* under the California Bay-Delta Authority (SWPAO #05701-A1) on December 31, 2007, to extend the term of the agreement through December 31, 2008. This allowed DWR another year to return the 50,000 af of water that was previously delivered for support of the EWA.

DWR and Metropolitan completed their second and final year of the multiyear agreement in 2007 (SWPAO #06703 executed on July 25, 2006) for deferred water deliveries and repayment of up to 100,000 af per year that would provide additional water to the EWA, subject to compensation of services, in order to protect the San Luis Reservoir from being drawn down to the point where water quality issues would affect SWP and CVP contractors. Due to hydrologic conditions, there was no need for deferred water deliveries in 2007. An amendment to this contract was not executed.

### **Yuba County Water Agency**

DWR and Yuba executed the *Agreement for the Temporary Transfer of Water from Yuba County Water Agency to the Department of Water Resources* (SWPAO #07701) on May 16, 2007 for the transfer of up to 125,000 af from storage in New Bullards Bar Reservoir and groundwater substitution for support of the EWA as the second pilot year transfer under the water purchase agreement of the pending Yuba River Accord. DWR had

purchased 62,000 af of water from Yuba in 2006, but the water could not be delivered in 2006 due to unfavorable Delta transfer conditions. This agreement allowed Yuba to provide DWR a credit for payment of 62,000 af toward the cost of future water sales since no water was delivered to the EWA in 2006. DWR initially purchased an additional 60,000 af from Yuba for the EWA in 2007.

DWR and Yuba later executed Amendment No. 1 to *Agreement for the Temporary Transfer of Water from Yuba County Water Agency to the Department of Water Resources* (SWPAO #07701-A1) on December 5, 2007, for the additional 3,000 af. As a result of favorable Delta transfer conditions in 2007, Yuba was able to release 125,000 af for EWA purposes. Of the 125,000 af released by Yuba, all but 11,400 af was available for export in 2007 and the remaining 11,400 af was stored in Lake Oroville for transfer when Delta conditions allow.

### **Operational Assets**

In 2007, the EWA used its operational flexibility to export 212,933 af of excess flows in the Delta using available capacity at Banks Pumping Plant to reduce the EWA debt in San Luis Reservoir. DWR pumped 26,667 af in January while Reclamation did not pump any water to reduce the EWA debt, making the combined projects' pumping total for reducing the EWA debt equal to 26,667 af. In 2007, the EWA did not realize any gain from its allocated share of the SWP water gain from the Central Valley Project Improvement Act (CVPIA) Section 3406 (b)(2) fish actions release.

### **Lower Yuba River Accord**

The Yuba Accord includes three separate but related agreements, all of which had to be in place for the Yuba Accord to become effective: a fisheries agreement among Yuba, DFG, and other entities; a conjunctive use agreement between Yuba and water districts



in Yuba County; and a water purchase agreement between Yuba and DWR. The Lower Yuba River Fisheries Agreement finalized on October 11, 2007, states that it will become effective when (1) DWR and Yuba execute their water purchase agreement; (2) Yuba executes conjunctive use agreements with its member units; and (3) Yuba executes an agreement or memorandum of understanding with Pacific Gas & Electric Company (PG&E) to make the necessary amendments to the 1966 Yuba/PG&E Power Purchase Contract for the implementation of the fisheries agreement. All of the necessary Yuba Accord agreements were executed.

DWR and Yuba executed the *Agreement for the Long-Term Purchase of Water from Yuba County Water Agency by the Department of Water Resources* (Tier 1 Agreement) (SWPAO #08800) on December 4, 2007, for the purchase of 60,000 af of water per year for 8 years from Yuba to the EWA, for a total of \$30.9 million. The agreement is effective through December 31, 2025. Due to Yuba's Federal Energy Regulatory Commission (FERC) relicensing, quantities and price of water for the remaining 10 years of the contract will be negotiated after 8 years.

DWR and Reclamation drafted but did not execute the *Agreement between the United States Department of the Interior, Bureau of Reclamation, and the State of California Department of Water Resources for Sharing of Water Purchased from the Yuba County Water Agency for the Lower Yuba River Accord* (Tier 2 Agreement) for a 50-50 percent split in sharing Component 2, 3, and 4 water between the SWP and federal CVP contractors. As a consequence of Reclamation's inability to execute the agreement during certain Delta-related litigation, DWR replaced Reclamation in the water purchase agreements by contracting directly with the federal participants and assuring the 50-50 split in Component 2, 3, and 4 water.

DWR executed the first three Tier 3 Agreements with Metropolitan, Kern, and the San Luis & Delta-Mendota Water Authority (San Luis & Delta-Mendota) titled *Agreement for the Supply and Conveyance of Water by the Department of Water Resources of the State of California to the Participating State Water Project Contractors Under the Dry Year Water Purchase Program and Agreement for the Supply and Conveyance of Water by the Department of Water Resources of the State of California to the San Luis & Delta-Mendota Water Authority Under the Dry Year Water Purchase Program* (SWPAO #s 08801 through 08803) on December 21, 2007, for the purchase of Component 2, 3, and 4 water from Yuba.

## Miscellaneous Agreements with Other Agencies

In addition to negotiating agreements with SWP water contractors to provide for specified water deliveries, DWR also entered into several agreements with other agencies for water conveyance, or exchange, between January 1, 2007, and December 31, 2007.

## Water Conveyance Agreements—CVP Water

DWR regularly enters into agreements to convey CVP water for contractors receiving water from Reclamation through the Cross Valley Canal (CVC), a water conveyance facility that connects with the California Aqueduct, Milepost 238.04, in Kern County. Corporations or other water agencies receive CVP water through agreements between DWR and Reclamation, including the U.S. Department of Veterans Affairs, U.S. Fish and Wildlife Service (USFWS), and Musco Family Olive Company. Occasionally, DWR also enters into agreements with Reclamation to convey CVP or SWP water from the Delta to O'Neill Forebay through CVP or SWP facilities. Some of these agreements allow Reclamation to make up for curtailed water exports from C.W. "Bill" Jones (Jones)

Pumping Plant associated with improving conditions for fish in the Delta. Other agreements allow the replacement of water exports foregone during maintenance and repair of Jones and Banks pumping plants and CVP and SWP conveyance facilities between the Delta and O'Neill Forebay.

### **Cross Valley Canal**

Through long-term three party contracts with Reclamation and DWR, eight CVP water contractors began to receive CVP water via the California Aqueduct to the CVC. The following eight CVP water contractors are defined as CVC Contractors: County of Fresno (Fresno), County of Tulare (Tulare), Hills Valley Irrigation District (Hills Valley), Kern-Tulare Water District (Kern-Tulare), Lower Tule River Irrigation District (Lower Tule), Pixley Irrigation District (Pixley), Rag Gulch Water District (Rag Gulch), and the Tri-Valley Water District (Tri-Valley). Fresno, Tulare, Lower Tule, and Pixley executed contracts in 1975. Hill's Valley, Kern-Tulare, Rag Gulch, and Tri-Valley executed contracts in 1976. All eight original contracts terminated on December 31, 1995. In 1995, amendments were executed that extended the termination date to February 29, 1996 for all contracts. Interim Renewal (IR) contracts have been executed during the ensuing years to extend the termination date as follows:

- March 1, 1996 through February 28, 1998 (IR1);
- March 1, 1998 through February 28, 2000 (IR2);
- March 1, 2000 through November 30, 2000 (IR3);
- December 1, 2000 through February 28, 2001 (IR4);
- March 1, 2001 through February 28, 2002 (IR5);
- March 1, 2002 through February 28, 2003 (IR 6);
- March 1, 2003 through February 29, 2004 (IR 7);
- March 1, 2004 through February 28, 2005 (IR 8);
- March 1, 2005 through February 28, 2006 (IR 9);
- March 1, 2006 through February 28, 2007 (IR 10); and
- March 1, 2007 through February 29, 2008 (IR 11).

During the period July 2007 through October 2007, DWR delivered a total of 6,398 af of 2007-2008 CVP water to the CVC contractors as follows: Fresno 1,500 af, Hills Valley 1,673 af, Tri-Valley 571 af, and Tulare 2,654 af.

During 2007, CVC contractors executed the following change in POD agreements of CVP water with DWR. All the listed deliveries were made using the DWR portion of the San Luis Canal.

- Lower Tule to Westlands for up to 22,500 af; DWR delivered 1,551 af through Reaches 4-7 (SWPAO #07308);
- Lower Tule to Del Puerto Water District (Del Puerto), for up to 10,500 af, DWR delivered 10,500 af to Reach 3 (SWPAO #07310);
- Lower Tule to San Luis Water District, for up to 3,500 af, DWR delivered 3,500 af to Reach 3 (SWPAO #07315);
- Pixley to Westlands, for up to 22,500 af, DWR delivered 5,051 af to Reaches 4-7 (SWPAO #07309);
- Pixley to Del Puerto, for up to 10,500 af, DWR delivered 10,500 af to Reach 3 (SWPAO #07311);
- Kern-Tulare to Westlands, for up to 10,000 af, DWR delivered 8,419 af to Reaches 4-7 (SWPAO #07316);
- Rag Gulch to Westlands, for up to 5,000 af, DWR delivered 2,802 af to Reaches 4-7 (SWPAO #07317).

### ***Byron Bethany Irrigation District–Musco Family Olive Company***

A pending agreement among Byron-Bethany Irrigation District (Byron-Bethany), DWR, and Reclamation provides for the conveyance of up to 800 af of Byron-Bethany's CVP water to Reach 2A of the California Aqueduct for use by Musco Family Olive Company. A total of 354 af was delivered in 2007 under this pending agreement (SWPAO #04300). Construction of a permanent turnout is currently being pursued. Note: On August 12, 2004, Plain View Water District became part of Byron-Bethany. Starting with SWPAO #04300, Byron-Bethany will execute conveyance agreements for CVP water to be used by Musco Family Olive Company.

### ***U.S. Department of Veterans Affairs***

A pending letter agreement among the U.S. Department of Veterans Affairs, DWR, and Reclamation provides for the conveyance of up to 850 af of CVP-approved water to Reach 2B of the California Aqueduct to the U.S. Department of Veterans Affairs' San Joaquin Valley National Cemetery. A total of 113 af was delivered to the National Cemetery from Reach 2B of the California Aqueduct in 2007 under this pending agreement. (SWPAO #03312)

### ***U.S. Fish and Wildlife Service Cooperative Agreement***

Reclamation initiated a cooperative agreement with DWR to deliver CVP water to the Kern National Wildlife Refuge for USFWS. Under the terms of this cooperative agreement, dated September 28, 2004, up to 30,500 af of CVP water would be delivered from the end of Reach 7, to the Buena Vista Water Storage District (Buena Vista) Turnout BV-1B, Reach 10A of the California Aqueduct, from May 1, 2002, to May 31, 2012. DWR conveyed 7,526 af of CVP water to Kern National Wildlife Refuge in 2007. (SWPAO #03317)

## **Water Deliveries**

### **Table A Deliveries**

Each year, by October 1, the SWP water contractors submit initial requests for Table A deliveries allocated to them for use in the subsequent calendar year. Initial Table A allocation amounts for the coming year are made by DWR in December. They are based on operations studies that assume 90 percent exceedence of historical water supply (where exceedence refers to the possibility that water supply in the coming year will be exceeded by the historical water supply), current reservoir storage, and total requests by the SWP water contractors. Forecasts for the year are updated as hydrologic conditions change. Table A amounts are increased or decreased depending on both actual and projected hydrologic conditions, though decreases are rare as the 90 percent exceedence criteria is fairly conservative.

On October 1, 2006, SWP water contractors submitted initial requests for 2007 totaling 4.13 maf.

DWR approved deliveries of 2.47 maf on November 30, 2006, resulting in initial Table A amounts of 60 percent of most SWP water contractor requests.

Notices to State Water Project Contractors informing them of increases or decreases in Table A amounts are online at <http://www.water.ca.gov/swpao/notices.cfm>.

### **2007 SWP Deliveries**

The SWP delivers water for a variety of beneficial uses. In addition to delivering Table A water to SWP water contractors, the SWP:

- conveys water to other public and local agencies through special contracts and agreements;
- provides water for wildlife and

recreational uses; and

- stores, releases, and delivers local runoff water from SWP facilities to agencies that hold local water rights.

In 2007, 4,061,696 af was delivered to 27 SWP water contractors and 26 other agencies, categorized as follows:

- 1,986,455 af of Table A water;
- 309,973 af of Article 21 water;
- 94,762 af of 2006 carryover water;
- 2,581 af of SWP water for recreation and fish and wildlife;
- 1,258,278 af of nonproject water delivered to satisfy settlement agreements and agreements with SWP water contractors for local water supplies; and
- 114,492 af delivered to satisfy agreements between the SWP and CVP.

Figure 9-1 shows amounts of water delivered to various locations during 2007.

Specific information about water deliveries made to SWP water contractors and other agencies during 2007, and historical deliveries from 1962 through 2007, are presented in the following three sections, each with a corresponding table, located at the end of the chapter:

- Water Delivered to Long-Term Water Supply Contractors in 2007, by Service Area (Table 9-3);
- Water Delivered in 2007, by Month (Table 9-4); and
- Total Amounts of Annual Table A Water and Water Conveyed, by Type, 1962–2007 (Table 9-5).

Please note that the water delivery figures listed are accurate at the time of this Bulletin 132 publication, but small volumes of water may be reclassified over time pursuant to long-term water supply

contract provisions. If your research requires more current data than was available at the time of publication, please consult the most recent edition of Bulletin 132 and/or contact DWR staff in the State Water Project Analysis Office.

## **2007 Water Deliveries to Long-Term SWP Water Contractors**

Table 9-3 shows amounts of water delivered in 2007, by service area. The following information is arranged by column number.

### ***Table A Water Delivered***

Columns 1 through 5 show a detailed breakdown of Table A water delivered for SWP water contractors in 2007.

### ***Turn-Back Pool Water***

Column 4 shows 16,380 af of Turn-Back Pool water was delivered to SWP water contractors in 2007.

### ***2006 Carryover Table A Water Delivered During 2007***

Column 6 shows a total of 94,762 af was carried over from 2006 for delivery in 2007.

The carryover program was designed to encourage the most effective and beneficial use of water and to avoid obligating the contractors to use or lose the water by December 31 of each year. The SWP water contractors' long-term contracts and amendments state the criteria for carrying over Table A water from one year to the next, under Articles 12(e), 14(b), and 56(c).

### ***Total Table A Water Delivered***

Column 7 shows all Table A water delivered in 2007—a total of 2,081,217 af.

### ***Article 21 and Unscheduled Water***

Column 8 shows 309,973 af of 2007 Article 21 water was delivered to SWP water contractors (which includes 308,801 af of



**Figure 9-1 Water Delivered in 2007 and Delivery Locations of Long-Term Water Supply Contractors and Feather River Area Districts with Water Rights Agreements with DWR**

Article 21 and 1,172 af of unscheduled water to Empire). SWP water contractors who have not signed the Monterey Amendments receive unscheduled water.

### **Other SWP Water**

Column 9 shows 125,772 af of other SWP water. Other SWP water includes flexible withdraw water from Castaic Lake and Lake Perris, and settlement water.

### **Total SWP Water Delivered**

Column 10 shows 2,516,962 af of total SWP water was delivered in 2007. This includes total Table A water, 2006 Table A carryover water, Article 21 water, and Other SWP water.

### **Non-SWP Water Deliveries to Long-Term SWP Contractors**

Columns 11 and 12 include deliveries of non-SWP water to long-term water contractors. Column 11 shows 179,951 af of water bank recovery water. Column 12 shows 77,042 of other non-SWP water. Non-SWP water is local and permit water that an SWP water contractor has a water right to, or water purchased from, exchanged with, or transferred from non-SWP agencies. In 2007, non-SWP water deliveries totaled 256,993 af.

### **Total Deliveries**

Column 13 shows total amounts of water delivered to SWP water contractors. In 2007, the SWP delivered 2,773,955 af to 29 long-term contractors.

### **Water Delivered in 2007 by Month**

During 2007, the SWP provided water service to 53 agencies, including 29 SWP water contractors. Those agencies and the amounts of water delivered to them by month are listed in Table 9-4 and are summarized below as SWP water and non-SWP water.

### **SWP Water**

SWP water, as defined in the long-term water supply contracts, includes Article 21 water, carryover Table A water, current year Table A amounts, transfer and exchange of Table A water, and Turn-Back Pools A and B. Detailed information concerning those conveyances is found under the "Miscellaneous Agreements with Long-Term SWP Water Contractors" section in this chapter.

### **2007 Non-SWP Water**

In 2007, DWR used SWP facilities to convey water for various agencies according to the terms of water rights settlement agreements and water transfer and exchange agreements. Detailed information concerning those conveyances is found under the "Miscellaneous Agreements with Other Agencies" section in this chapter.

### **Water Rights Water**

Water in this category is transported through SWP facilities to long-term SWP water contractors and other agencies according to terms of various settlement agreements. Some water simply passes through SWP transportation facilities; some portion is stored in SWP reservoirs for release later. In 2007, 1,258,278 af in this category was delivered to the Feather River, Delta, South Bay, North Bay, and Southern California areas, as summarized below.

**Feather River Area.** Nine non-SWP agencies in the Feather River area received 1,192,276 af:

- Last Chance Creek Water District, 12,304 af;
- Thermalito Irrigation District, 1,781 af;
- South Feather Water and Power Agency, formerly Oroville-Wyandotte Irrigation District, 5,595 af;
- Western Canal Water District, 329,924 af;
- Joint Water District Board, 821,094 af;
- Oswald Water District, 490 af;

- Tudor Mutual Water Company, 2,270 af;
- Garden Highway Mutual Water Company, 14,208 af; and
- Plumas Mutual Water Company, 4,610 af.

**Delta.** In the Delta, 25,714 af of Byron-Bethany Irrigation District water was delivered pursuant to the May 28, 2003, *Agreement Between the Department of Water Resources of the State of California and the Byron-Bethany Irrigation District Regarding the Diversion of Water from the Delta*.

**North Bay Area.** In the North Bay area, 11,801 af of Vallejo permit water and 10,568 af of water pursuant to the May 19, 2003, *Settlement Agreement among DWR, Solano County Water Agency, and the Cities of Fairfield, Vacaville, and Benicia*, was delivered.

**South Bay Area.** In the South Bay area, a total of 17,794 af of local water was delivered to Alameda-Zone 7 and Alameda County. These two South Bay Aqueduct (SBA) SWP water contractors hold water rights to runoff from the Lake del Valle watershed.

**Southern California.** In Southern California, 125 af of local runoff from the Houston Creek watershed was stored and delivered to Crestline under water rights held by DWR on Houston Creek. The authorized place of use is limited to Crestline.

## Annual Table A Water and Water Delivered Since 1962

Information about annual Table A water and water conveyed for the past 45 years is contained in Table 9-5. The following discussion of conveyed Table A water is arranged according to column numbers.

### Annual Table A Water

Columns 1 through 7 of Table 9-5 show the amount of SWP water contractors' annual Table A water by area for years 1962 through

2007 as specified in the Table A schedules of the long-term water supply contracts.

In some instances, Table A schedules—projections of each contractor's need for water to 2035—have been amended to meet the needs of individual contractors. The amounts of annual Table A water each SWP water contractor may request for years 1962 through 2035 can be found in Table B-4 in Appendix B.

### Water Delivered

Columns 8 through 16 show water delivered or conveyed, including initial fill water and operational losses and storage changes.

**Table A Water.** Column 8 shows amounts of Table A water delivered each year from 1962 through 2007. In 2007, a total of 2,081,217 af of Table A water was delivered.

**Article 21 and Unscheduled Water.** Column 9 shows amounts of Article 21 water, as defined under SWP deliveries, and unscheduled water delivered from 1962 through 2007. Article 21 and unscheduled water is water in excess of that required to meet all demands for the year's Table A water and water to be stored in SWP reservoirs. In 2007, a total of 309,973 af of Article 21 and unscheduled water was delivered.

**Other Water.** Column 10 includes amounts of water classified as other water delivered in 2007, including non-SWP water conveyed through SWP facilities and regulated delivery of local supply. In 2007, a total of 449,935 af of other water was delivered.

**Feather River Diversions.** Column 11 includes amounts of water from the Feather River delivered according to agreements for water rights water. Column 11 also includes Delta diversions. In 2007, a total of 1,217,990 af in this category was delivered to agencies in the Feather River area, including 25,714 af delivered to Byron-Bethany in the Delta.

**Recreation Water.** Column 12 shows water conveyed for recreational use or to improve habitat or water quality for fish and wildlife. In 2007, 2,581 af of SWP water was conveyed for this purpose.

**Initial Fill Water.** The quantities listed in Column 14 represent the amounts used to initially fill the aqueducts and reservoirs south of the Delta to maximum operating capacities. Initial filling began with the SBA in 1962, and was completed in 1979, when Lake Perris reached its maximum operating capacity of 127,000 af. In 1996 and 1997, the Coastal Aqueduct was initially filled.

**Operational Losses.** Column 15 includes the total amounts of water lost through evaporation and seepage, net storage changes in reservoirs south of the Delta, and amounts of inflow from local drainage areas, including inflows into San Luis Canal and from the Kern River Intertie. Negative values are indicated for years when withdrawals and evaporation from reservoirs south of the Delta exceed the amounts of water added to the reservoirs.



**Table 9-3 Water Delivered to Long-Term Contractors in 2007, by Service Area (Acre-Feet)**

SWP Contractor	Table A Water Delivered										Non-SWP			Total Water Delivered (13)				
	Table A not Transferred, Exchanged, or Stored (1)					Table A Transferred or Exchanged (2)					Total Table A (7)	Article 21 (8)	Other SWP (9)		Total SWP Water (10)	Water Bank Recovery (11)	Other Non-SWP (12)	
	Table A not Transferred, Exchanged, or Stored (1)	Table A Transferred or Exchanged (2)	Table A Stored (3)	Turnback Pools (4)	Total Table A (5)	2006 Carryover (6)	Total Table A (7)											
<b>Feather River</b>																		
County of Butte	956				956					956								956
Plumas County FC&WCD					0					0								0
City of Yuba City	2,327				2,327					2,327								2,327
<b>North Bay</b>																		
Napa County FC&WCD	6,362				6,362	998	7,360			7,360								10,957
Solano County WA	14,892				14,892	1,822	16,714			16,714			10,568				11,801	47,300
<b>South Bay</b>																		
Alameda County FC&WCD-Zone 7	32,972			378	33,350	2,895	36,245			36,245								51,353
Alameda County WD	16,541			197	16,738	2,103	18,841			18,841					5,000		6,598	30,989
Santa Clara Valley WD	38,812			469	39,281	8,161	47,442			47,442					20,000		3,100	75,382
<b>San Joaquin Valley</b>																		
Castaic Lake WA (SJV)	4,424				4,424	1,647	6,071			6,071								6,071
County of Kings	4,924			43	4,967	305	5,272			5,272								5,746
Dudley Ridge Water District	26,937	6,976		269	34,182	2,000	36,182			36,182								45,135
Empire-West Side ID	397				397	515	912			912								2,084
Kern County WA	337,443	18,214		4,683	360,340	19,645	379,985			379,985					5,740		25,296	510,882
Oak Flat Water District	3,430			27	3,457	69	3,526			3,526								3,567
Tulare Lake Basin WSD	51,127	6,145		450	57,722	16,459	74,181			74,181								87,083
<b>Central Coastal</b>																		
San Luis Obispo County FC&WCD	3,752				3,752		3,752			3,752								3,776
Santa Barbara County FC&WCD	24,760	520			25,280	1,390	26,670			26,670								27,740
<b>Southern California</b>																		
Antelope Valley-East Kern WA	74,039	1,800			75,839	4,364	80,203			80,203								80,203
Castaic Lake WA	32,350		8,200		40,550	2,569	43,119			43,119								54,119
Coachella Valley WD	72,660			568	73,228		73,228			73,228								73,228
Crestline-Lake Arrowhead Water Agency	1,768				1,768		1,768			1,768							125	1,893
Desert Water Agency	30,000			234	30,234		30,234			30,234								30,234
Littlerock Creek ID	0				0		0			0								-
Metropolitan Water District of SC	1,047,046			8,962	1,056,008	28,098	1,084,106			1,084,106								1,515,038
Mojave Water Agency	19,372				19,372	737	20,109			20,109								20,109
Palmdale Water District	12,780			100	12,880	985	13,865			13,865								19,634
San Bernardino Valley MWD	26,406	30,710			57,116		57,116			57,116								57,116
San Gabriel Valley MWD	4,024				4,024		4,024			4,024								4,024
San Geronimo Pass WA	4,009				4,009		4,009			4,009								4,009
Ventura County WPD	3,000				3,000		3,000			3,000								3,000
<b>Total</b>	<b>1,897,510</b>	<b>64,365</b>	<b>8,200</b>	<b>16,380</b>	<b>1,986,455</b>	<b>94,762</b>	<b>2,081,217</b>	<b>309,973</b>	<b>125,772</b>	<b>2,516,962</b>	<b>179,951</b>	<b>77,042</b>	<b>2,773,955</b>					

**Table 9-4 Total Amounts of Water Delivered in 2007, by Month (Acre-Feet)**

Contracting Agency and Type of Service	Jan	Feb	Mar	Apr	May	June	July	Aug	Sept	Oct	Nov	Dec	2007 Total Deliveries
<b>FEATHER RIVER AREA</b>													
<i>SWP Agencies</i>													
City of Yuba City	0	0	0	0	0	117	1,125	1,077	8	0	0	0	2,327
Table A	9	137	82	221	93	21	137	6	6	3	4	1	720
County of Butte	0	0	0	0	0	0	78	109	49	0	0	0	236
Table A	9	137	82	221	93	138	1,340	1,192	63	3	4	1	3,283
Plumas County Flood Control and Water Conservation District	0	0	0	0	0	0	0	0	0	0	0	0	0
Table A	2	0	0	1	4	0	0	1	0	0	0	0	9
Recreation/Fish and Wildlife (SWP)													
Recreation/Fish and Wildlife													
<i>Non-SWP Agencies</i>													
Garden Highway Mutual Water Company	0	0	0	991	1,438	1,807	3,238	1,488	2,247	2,561	438	0	14,208
Regulated delivery of local supply													
Joint Water Districts Board	48,113	0	0	45,090	125,760	120,633	127,340	109,460	45,020	44,688	86,100	68,890	821,094
Regulated delivery of local supply													
Last Chance Creek Water District	0	112	0	42	3,328	3,084	2,505	2,225	692	232	44	40	12,304
Regulated delivery of local supply													
Oswald Water District	0	0	0	0	1	174	154	96	65	0	0	0	490
Regulated delivery of local supply													
Plumas Mutual Water Company	0	0	56	740	124	1,826	746	482	636	0	0	0	4,610
Regulated delivery of local supply													
South Feather Water and Power Agency	161	164	18	0	655	893	962	990	924	440	298	90	5,595
Regulated delivery of local supply													
Thermalito Irrigation District	118	42	126	112	197	204	221	262	234	154	111	0	1,781
Regulated delivery of local supply													
Tudor Mutual Water Company	0	0	42	513	656	346	219	414	80	0	0	0	2,270
Regulated delivery of local supply													
Western Canal Water District	5,868	0	0	10,415	63,041	58,333	64,671	29,823	9,336	26,450	44,305	17,682	329,924
Regulated delivery of local supply													
SWP	11	137	82	222	97	138	1,340	1,193	63	4	4	1	3,292
Non-SWP	54,260	318	242	57,903	195,200	187,300	200,056	145,240	59,234	74,525	131,296	86,702	1,192,276
<b>Feather River Area Total</b>	<b>54,271</b>	<b>455</b>	<b>324</b>	<b>58,125</b>	<b>195,297</b>	<b>187,438</b>	<b>201,396</b>	<b>146,433</b>	<b>59,297</b>	<b>74,529</b>	<b>131,300</b>	<b>86,703</b>	<b>1,195,568</b>

**Table 9-4 Total Amounts of Water Delivered in 2007, by Month (Acre-Feet)**

Contracting Agency and Type of Service	Jan	Feb	Mar	Apr	May	June	July	Aug	Sept	Oct	Nov	Dec	2007 Total Deliveries
<b>NORTH BAY AREA</b>													
<i>SWP Agencies</i>													
Napa County Flood Control and Water Conservation District													
Table A	0	2	5	100	123	1,171	681	685	755	609	1,168	888	6,187
Table A POD through Solano*	0	3	6	5	22	60	31	23	8	10	5	2	175
Article 56(c) carryover	993	0	0	0	0	0	0	0	0	0	0	0	993
Article 56(c) carryover POD through Solano*	5	0	0	0	0	0	0	0	0	0	0	0	5
Article 21	0	882	577	866	1,141	0	0	0	0	0	0	131	3,597
Vallejo Permit from Solano	0	0	0	0	0	0	213	223	64	0	0	0	500
Agency Total (*excluded from total)	993	884	582	966	1,264	1,171	894	908	819	609	1,168	1,019	11,277
Solano County Water Agency													
Table A	50	90	54	60	180	5,427	5,113	3,918	0	0	0	0	14,892
Table A POD for Napa	0	3	6	5	22	60	31	23	8	10	5	2	175
Article 56(c) carryover	1,822	0	0	0	0	0	0	0	0	0	0	0	1,822
Article 56(c) carryover POD for Napa	5	0	0	0	0	0	0	0	0	0	0	0	5
Article 21	422	1,427	1,038	563	4,536	0	0	0	0	0	0	231	8,217
Settlement	0	0	0	1,286	0	0	0	0	3,427	2,202	2,654	999	10,568
Vallejo Permit	0	100	99	197	100	100	1,682	2,720	2,533	1,738	1,473	559	11,301
Vallejo Permit to Napa*	0	0	0	0	0	0	213	223	64	0	0	0	500
Agency Total (*excluded from total)	2,299	1,620	1,197	2,111	4,838	5,587	6,826	6,661	5,968	3,950	4,132	1,791	46,980
SWP	3,292	2,404	1,680	2,880	6,002	6,658	5,825	4,626	4,190	2,821	3,827	2,251	46,456
Non-SWP	0	100	99	197	100	100	1,895	2,943	2,597	1,738	1,473	559	11,801
<b>North Bay Area Total</b>	<b>3,292</b>	<b>2,504</b>	<b>1,779</b>	<b>3,077</b>	<b>6,102</b>	<b>6,758</b>	<b>7,720</b>	<b>7,569</b>	<b>6,787</b>	<b>4,559</b>	<b>5,300</b>	<b>2,810</b>	<b>58,257</b>
<b>SOUTH BAY AREA</b>													
<i>SWP Agencies</i>													
Alameda County Flood Control and Water Conservation District, Zone 7													
Table A	0	28	89	208	3,977	3,707	5,872	5,303	4,548	3,127	3,514	2,599	32,972
Pool A	0	0	0	0	0	0	378	0	0	0	0	0	378
Article 56(c) carryover	2,645	0	0	0	0	0	0	0	0	0	0	0	2,645
Article 56(c) carryover to Semitropic*	250	0	0	0	0	0	0	0	0	0	0	0	250
Article 21	0	338	107	0	0	0	0	0	0	0	0	0	445
Article 21 to Semitropic*	0	467	0	0	0	0	0	0	0	0	0	0	467

**Table 9-4 Total Amounts of Water Delivered in 2007, by Month (Acre-Feet)**

Contracting Agency and Type of Service	Jan	Feb	Mar	Apr	May	June	July	Aug	Sept	Oct	Nov	Dec	2007 Total Deliveries
Local	123	2,058	3,002	3,668	1,085	697	57	200	172	134	0	0	11,196
Transfer from Byron-Bethany Irrigation District	0	0	0	0	0	0	0	1,000	1,000	1,000	0	0	3,000
Agency Total (*excluded from total)	2,768	2,424	3,198	3,876	5,062	4,404	6,307	6,503	5,720	4,261	3,514	2,599	50,636
Alameda County Water District													
Table A	0	0	0	0	1,826	721	3,655	3,468	2,023	2,057	2,172	619	16,541
Pool A	0	0	0	0	0	197	0	0	0	0	0	0	197
Article 56(c) carryover	1,525	0	0	0	0	0	0	0	0	0	0	0	1,525
Article 56(c) carryover to Semitropic*	578	0	0	0	0	0	0	0	0	0	0	0	578
Article 21	0	0	99	0	0	0	0	0	0	0	0	0	99
Article 21 to Semitropic*	0	451	0	0	0	0	0	0	0	0	0	0	451
Semitropic Recovery	0	0	0	0	0	0	0	0	1,043	1,057	1,694	1,206	5,000
Local	0	0	468	3,270	1,167	1,693	0	0	0	0	0	0	6,598
Agency Total (*excluded from total)	1,525	0	567	3,270	2,993	2,611	3,655	3,468	3,066	3,114	3,866	1,825	29,960
Santa Clara Valley Water District													
Table A	0	0	5,688	3,164	0	0	7,475	8,558	4,270	3,646	3,489	2,522	38,812
Pool A	0	0	0	0	0	0	469	0	0	0	0	0	469
Article 56(c) carryover	6,811	0	0	0	0	0	0	0	0	0	0	0	6,811
Article 56(c) carryover to Semitropic*	1,350	0	0	0	0	0	0	0	0	0	0	0	1,350
Article 21	0	874	1,624	0	0	0	0	0	0	0	0	0	2,498
Article 21 to Semitropic*	0	2,342	0	0	0	0	0	0	0	0	0	0	2,342
Semitropic Recovery	0	0	0	0	5,454	4,719	0	0	3,000	0	3,000	3,827	20,000
Transfer from Browns Valley Irrigation District	0	0	0	0	0	0	0	0	0	3,100	0	0	3,100
Agency Total (*excluded from total)	6,811	874	7,312	3,164	5,454	4,719	7,944	8,558	7,270	6,746	6,489	6,349	71,690
Non-SWP Agencies													
Byron-Bethany Irrigation District													
Regulated delivery of local supply	848	279	2,223	4,003	4,356	4,152	4,213	2,945	1,849	560	162	124	25,714
Recreation/Fish and Wildlife (SWP)													
Lake del Valle	3	2	0	8	18	23	21	22	16	13	8	4	138
SWP	10,984	1,242	7,607	3,380	11,275	9,367	17,870	17,351	14,900	9,900	13,877	10,777	128,530
Non-SWP	971	2,337	5,693	10,941	6,608	6,542	4,270	4,145	3,021	4,794	162	124	49,608
<b>South Bay Area Total</b>	<b>11,955</b>	<b>3,579</b>	<b>13,300</b>	<b>14,321</b>	<b>17,883</b>	<b>15,909</b>	<b>22,140</b>	<b>21,496</b>	<b>17,921</b>	<b>14,694</b>	<b>14,039</b>	<b>10,901</b>	<b>178,138</b>

**Table 9-4 Total Amounts of Water Delivered in 2007, by Month (Acre-Feet)**

Contracting Agency and Type of Service	Jan	Feb	Mar	Apr	May	June	July	Aug	Sept	Oct	Nov	Dec	2007 Total Deliveries
<b>SAN JOAQUIN VALLEY AREA</b>													
<i>SWP Agencies</i>													
Castaic Lake Water Agency													
Table A	0	871	282	2,849	422	0	0	0	0	0	0	0	4,424
Table A to Rosedale-Rio*	0	0	0	0	0	4,100	4,100	0	0	0	0	0	8,200
Article 56(c) carryover	1,647	0	0	0	0	0	0	0	0	0	0	0	1,647
Agency Total (*excluded from total)	1,647	871	282	2,849	422	0	0	0	0	0	0	0	6,071
County of Kings													
Table A	0	0	138	63	0	0	1,679	211	0	0	0	0	2,091
Table A POD through WWD*	1	0	94	406	444	213	411	439	330	253	156	86	2,833
Pool A	0	0	0	0	0	0	31	6	0	0	0	6	43
Article 12(e) carryover	305	0	0	0	0	0	0	0	0	0	0	0	305
Article 21	0	117	71	0	0	0	0	0	0	0	0	0	188
Article 21 through WWD*	102	112	72	0	0	0	0	0	0	0	0	0	286
Agency Total (*excluded from total)	305	117	209	63	0	0	1,710	217	0	0	0	6	2,627
Dudley Ridge Water District													
Table A	94	303	0	486	2,697	4,869	7,677	6,060	2,363	2,065	276	47	26,937
Table A Transfer to KCWA*	0	0	0	0	0	0	1,000	0	0	0	0	0	1,000
Table A Exchange from KCWA	0	0	0	0	0	2,000	0	0	0	0	0	0	2,000
Table A Exchange from SGVMWD	0	0	0	0	0	2,000	2,000	1,976	0	0	0	0	5,976
Table A Exchange to Santa Barbara County FCWCD*	0	0	0	0	0	0	0	0	520	0	0	0	520
Pool A	0	0	0	0	0	0	0	0	269	0	0	0	269
Article 56(c) carryover POD for Tulare	305	0	0	0	0	0	0	0	0	0	0	0	305
Article 56(c) carryover Transfer to KCWA*	2,000	0	0	0	0	0	0	0	0	0	0	0	2,000
Article 21	5,257	963	572	0	0	0	0	0	0	0	0	0	6,792
Article 21 POD for Tulare	454	0	0	0	0	0	0	0	0	0	0	0	454
Article 21 to Kern Water Bank*	1,284	506	371	0	0	0	0	0	0	0	0	0	2,161
Kern Water Bank Recovery	0	0	495	1,700	1,900	395	0	0	1,250	0	0	0	5,740
Agency Total (*excluded from total)	6,110	1,266	1,067	2,186	4,597	9,264	9,677	8,036	3,882	2,065	276	47	48,473
Empire-West Side Irrigation District													
Table A	0	0	1	0	64	27	0	305	0	0	0	0	397
Article 12(e) carryover	515	0	0	0	0	0	0	0	0	0	0	0	515
Article 21 unscheduled	1,047	71	54	0	0	0	0	0	0	0	0	0	1,172
Agency Total	1,562	71	55	0	64	27	0	305	0	0	0	0	2,084

**Table 9-4 Total Amounts of Water Delivered in 2007, by Month (Acre-Feet)**

Contracting Agency and Type of Service	Jan	Feb	Mar	Apr	May	June	July	Aug	Sept	Oct	Nov	Dec	2007 Total Deliveries
Kern County Water Agency													
Table A	0	3,843	37,392	16,361	50,555	97,376	85,385	35,708	9,792	0	0	0	336,412
Table A Transfer from Dudley Ridge	0	0	0	0	0	0	1,000	0	0	0	0	0	1,000
Table A Transfer to Westlands Water District*	0	0	0	0	0	0	4,000	12,214	0	0	0	0	16,214
Table A Exchange to Dudley Ridge*	0	0	0	0	0	2,000	0	0	0	0	0	0	2,000
Table A Exchange for Castaic Lake WA*	0	0	0	0	0	0	2,000	2,000	2,000	2,000	2,000	1,000	11,000
Table A Exchange for City of Tracy*	0	0	0	0	0	0	0	0	100	0	0	0	100
Table A Exchange for Kern National Wildlife Refuge	0	0	0	0	0	0	0	0	2,000	4,104	2,974	922	10,000
Table A Exchange for Palmdale Water District*	0	0	0	0	0	0	0	0	1,359	1,710	1,335	522	4,926
Table A POD to Western Hills Water District*	23	26	62	99	149	188	173	145	30	76	38	22	1,031
Table A for EWA	0	0	0	0	36,220	0	40,000	30,000	18,780	0	0	0	125,000
Pool A	0	0	0	0	0	0	0	4,683	0	0	0	0	4,683
Article 56(c) carryover	19,645	0	0	0	0	0	0	0	0	0	0	0	19,645
Article 56(c) Transfer from Dudley Ridge	2,000	0	0	0	0	0	0	0	0	0	0	0	2,000
Article 21	62,985	20,871	16,005	0	0	0	0	0	0	0	0	0	99,861
Article 21 POD from Dudley Ridge	1,284	506	371	0	0	0	0	0	0	0	0	0	2,161
Transfer from Kern-Tulare Water District	0	0	0	0	0	0	5,947	5,634	0	0	0	0	11,581
Transfer from Rag Gulch Water District	0	0	0	0	0	0	1,976	1,872	0	0	0	0	3,848
<i>Deliveries to Water Banks</i>													
ACF&WCD, Zone 7 Article 56(c) to Semitropic	250	0	0	0	0	0	0	0	0	0	0	0	250
ACF&WCD, Zone 7 Article 21 to Semitropic	0	467	0	0	0	0	0	0	0	0	0	0	467
ACWD Article 56(c) to Semitropic	578	0	0	0	0	0	0	0	0	0	0	0	578
ACWD Article 21 to Semitropic	0	451	0	0	0	0	0	0	0	0	0	0	451
CLWA Table A to Rosedale-Rio	0	0	0	0	0	4,100	4,100	0	0	0	0	0	8,200
MWDSC Article 21 to Arvin-Edison	745	1,136	0	0	0	0	0	0	0	0	0	0	1,881
SCWWD Article 56(c) to Semitropic	1,350	0	0	0	0	0	0	0	0	0	0	0	1,350
SCWWD Article 21 to Semitropic	0	2,342	0	0	0	0	0	0	0	0	0	0	2,342
City of Tracy to Semitropic	0	1,000	0	0	0	0	0	0	0	0	0	0	1,000

**Table 9-4 Total Amounts of Water Delivered in 2007, by Month (Acre-Feet)**

Contracting Agency and Type of Service	2007 Total Deliveries												
	Jan	Feb	Mar	Apr	May	June	July	Aug	Sept	Oct	Nov	Dec	
Westlands Water District to Semitropic	0	8,867	0	0	0	0	0	0	0	0	0	0	8,867
Water Bank Delivery Subtotal	2,923	14,263	0	0	0	4,100	4,100	0	0	0	0	0	25,386
Agency Total (*excluded from total)	88,837	39,483	53,768	16,361	50,555	101,476	98,408	47,897	9,792	0	0	0	506,577
Oak Flat Water District													
Table A	0	0	574	443	505	524	548	559	182	66	19	0	3,420
Unauthorized Table A	0	0	0	0	0	0	0	0	0	0	3	7	10
Pool A	0	0	0	0	0	0	27	0	0	0	0	0	27
Article 56(c) carryover	69	0	0	0	0	0	0	0	0	0	0	0	69
Article 21	0	13	28	0	0	0	0	0	0	0	0	0	41
Agency Total	69	13	602	443	505	524	575	559	182	66	22	7	3,567
Tulare Lake Basin Water Storage District													
Table A	0	0	3,535	3,792	10,462	13,388	7,226	11,142	0	0	151	1,431	51,127
Transfer Table A to Westlands Water District *	0	0	0	0	2,500	1,300	1,605	0	0	740	0	0	6,145
Pool A	0	0	0	0	0	0	431	18	0	0	0	1	450
Article 56(c) carryover	16,154	0	0	0	0	0	0	0	0	0	0	0	16,154
Article 56(c) POD through Dudley Ridge*	305	0	0	0	0	0	0	0	0	0	0	0	305
Article 21	8,410	2,481	1,557	0	0	0	0	0	0	0	0	0	12,448
Article 21 POD through Dudley Ridge*	454	0	0	0	0	0	0	0	0	0	0	0	454
Agency Total (* excluded from total)	24,564	2,481	5,092	3,792	10,462	13,388	7,657	11,160	0	0	151	1,432	80,179
Recreation/Fish and Wildlife (SWP)													
Department of Fish & Game, O'Neill	68	46	47	36	27	42	48	64	14	0	15	15	422
Parks and Recreation, O'Neill	3	0	3	0	2	1	3	0	1	1	1	0	15
Agency Total	71	46	50	36	29	43	51	64	15	1	16	15	437
Non-SWP Agencies													
Western Hills Water District													
Table A POD from KCWA	23	26	62	99	149	188	173	145	30	76	38	22	1,031
EWA Program													
SWP Gain*	0	0	0	0	0	0	18,620	26,460	15,680	5,710	16,787	0	83,257
Table A from KCWA*	0	0	0	0	36,220	0	40,000	30,000	18,780	0	0	0	125,000
CVP Water Annual Contractors													
Plain View WD/Musco Olive Company	29	31	35	29	32	33	4	10	26	62	36	27	354
U.S. Dept. of Veterans Affairs, S.J.V. National Cemetery	1	2	3	7	14	13	12	16	10	13	11	11	113

**Table 9-4 Total Amounts of Water Delivered in 2007, by Month (Acre-Feet)**

Contracting Agency and Type of Service	2007												
	Jan	Feb	Mar	Apr	May	June	July	Aug	Sept	Oct	Nov	Dec	Total Deliveries
Agency Total	30	33	38	36	46	46	16	26	36	75	47	38	467
Cross Valley Canal Contractors													
County of Tulare	0	0	0	0	0	0	741	1,913	0	0	0	0	2,654
Fresno County Public Works	0	0	0	0	0	0	437	1,063	0	0	0	0	1,500
Hills Valley Irrigation District	0	0	0	0	0	0	475	1,198	0	0	0	0	1,673
Kern-Tulare Water District:													
Transfer to KCWA*	0	0	0	0	0	0	5,947	5,634	0	0	0	0	11,581
POD through Westlands Water District*	0	0	0	0	0	0	0	3,835	4,584	0	0	0	8,419
Lower Tule River Irrigation District:													
POD through Del Puerto Water District*	0	0	0	0	0	0	3,011	4,914	2,575	0	0	0	10,500
POD through San Luis Water District*	0	0	0	0	0	0	1,102	1,798	600	0	0	0	3,500
POD through Westlands Water District*	0	0	0	0	0	0	418	682	451	0	0	0	1,551
Pixley Irrigation District:													
POD through Del Puerto Water District*	0	0	0	0	0	0	3,012	4,914	2,574	0	0	0	10,500
POD through Westlands Water District*	0	0	0	0	0	0	1,406	2,294	1,351	0	0	0	5,051
Rag Gulch Water District:													
Transfer to KCWA*	0	0	0	0	0	0	1,976	1,872	0	0	0	0	3,848
POD through Westlands Water District*	0	0	0	0	0	0	0	1,300	1,502	0	0	0	2,802
Tri-Valley Water District	0	0	0	0	0	0	171	400	0	0	0	0	571
Agency Total	0	0	0	0	0	0	1,824	4,574	0	0	0	0	6,398
U.S. Bureau of Reclamation													
Del Puerto Water District:													
POD from Lower Tule River Irrigation District	0	0	0	0	0	0	3,011	4,914	2,575	0	0	0	10,500
POD from Pixley Irrigation District	0	0	0	0	0	0	3,012	4,914	2,574	0	0	0	10,500
Del Puerto Water District:													
POD from Lower Tule River Irrigation District	0	0	0	0	0	0	1,102	1,798	600	0	0	0	3,500
Westlands Water District:													
Table A POD from County of Kings	1	0	94	406	444	213	411	439	330	253	156	86	2,833
Table A Transfer from KCWA	0	0	0	0	0	0	4,000	12,214	0	0	0	0	16,214



**Table 9-4 Total Amounts of Water Delivered in 2007, by Month (Acre-Feet)**

Contracting Agency and Type of Service	Jan	Feb	Mar	Apr	May	June	July	Aug	Sept	Oct	Nov	Dec	2007 Total Deliveries
Table A Transfer from Tulare Lake Basin WSD	0	0	0	0	2,500	1,300	1,605	0	0	740	0	0	6,145
Article 21 POD from County of Kings	102	112	72	0	0	0	0	0	0	0	0	0	286
General Conveyance to KCWA*	0	8,867	0	0	0	0	0	0	0	0	0	0	8,867
POD for City of Tracy	0	0	0	0	0	0	0	0	100	0	0	0	100
POD from Kern-Tulare Water District	0	0	0	0	0	0	0	3,835	4,584	0	0	0	8,419
POD from Lower Tule River Irrigation District	0	0	0	0	0	0	418	682	451	0	0	0	1,551
POD from Pixley Irrigation District	0	0	0	0	0	0	1,406	2,294	1,351	0	0	0	5,051
POD from Rag Gulch Water District	0	0	0	0	0	0	0	1,300	1,502	0	0	0	2,802
Kern National Wildlife Refuge	1,020	806	0	305	500	200	0	2,050	1,470	0	0	1,175	7,526
Table A Exchange from KCWA	0	0	0	0	0	0	0	0	2,000	4,104	2,974	922	10,000
Recreation	0	3	0	3	1	2	1	1	1	1	0	0	13
Fish and Wildlife	55	37	40	30	21	36	37	53	9	0	13	12	343
Agency Total (*excluded from total)	1,178	958	206	744	3,466	1,751	15,003	34,494	17,547	5,098	3,143	2,195	85,783
SWP	123,291	34,619	61,353	26,235	69,727	126,423	116,344	73,530	14,231	3,201	659	1,615	651,228
Non-SWP	1,105	10,746	78	374	568	284	18,750	33,947	17,253	4,180	3,034	2,147	92,466
<b>San Joaquin Valley Area Total</b>	<b>124,396</b>	<b>45,365</b>	<b>61,431</b>	<b>26,609</b>	<b>70,295</b>	<b>126,707</b>	<b>135,094</b>	<b>107,477</b>	<b>31,484</b>	<b>7,381</b>	<b>3,693</b>	<b>3,762</b>	<b>743,694</b>
<b>CENTRAL COASTAL AREA</b>													
<i>SWP Agencies</i>													
San Luis Obispo County Flood Control and Water Conservation District													
Table A	288	334	373	303	520	330	352	292	373	261	137	189	3,752
Pool A sale*	0	100	0	0	0	0	0	0	0	0	0	0	100
Article 21	24	0	0	0	0	0	0	0	0	0	0	0	24
Agency Total	312	334	373	303	520	330	352	292	373	261	137	189	3,776
Santa Barbara County Flood Control and Water Conservation District													
Table A	0	740	1,509	2,380	3,225	3,483	3,358	3,056	2,325	2,232	824	1,628	24,760
Table A Exchange from Dudley Ridge	0	0	0	0	0	0	0	0	520	0	0	0	520
Article 56(c) carryover	1,390	0	0	0	0	0	0	0	0	0	0	0	1,390
Article 21	0	417	653	0	0	0	0	0	0	0	0	0	1,070
Agency Total	1,390	1,157	2,162	2,380	3,225	3,483	3,358	3,056	2,845	2,232	824	1,628	27,740

**Table 9-4 Total Amounts of Water Delivered in 2007, by Month (Acre-Feet)**

Contracting Agency and Type of Service	Jan	Feb	Mar	Apr	May	June	July	Aug	Sept	Oct	Nov	Dec	2007 Total Deliveries
SWP	1,702	1,491	2,535	2,683	3,745	3,813	3,710	3,348	3,218	2,493	961	1,817	31,516
Non-SWP	0	0	0	0	0	0	0	0	0	0	0	0	0
<b>Central Coastal Area Total</b>	<b>1,702</b>	<b>1,491</b>	<b>2,535</b>	<b>2,683</b>	<b>3,745</b>	<b>3,813</b>	<b>3,710</b>	<b>3,348</b>	<b>3,218</b>	<b>2,493</b>	<b>961</b>	<b>1,817</b>	<b>31,516</b>
<b>SOUTHERN CALIFORNIA AREA</b>													
<i>SWP Agencies</i>													
Antelope Valley-East Kern Water Agency													
Table A	0	3,701	6,113	6,819	8,202	9,979	11,431	11,107	8,541	5,034	2,897	215	74,039
Table A POD from Mojave Water Agency	0	39	73	75	160	151	194	140	133	107	50	18	1,140
Table A Exchange from Littlerock Creek Irrigation District	0	0	0	0	0	0	0	0	0	0	0	1,380	1,380
Table A Exchange to Palmdale Water District*	0	0	0	0	210	210	0	0	0	0	0	0	420
Article 56(c) carryover	4,364	0	0	0	0	0	0	0	0	0	0	0	4,364
Article 56(c) carryover POD from Mojave Water Agency	36	0	0	0	0	0	0	0	0	0	0	0	36
Agency Total	4,400	3,740	6,186	6,894	8,362	10,130	11,625	11,247	8,674	5,141	2,947	1,613	80,959
<i>Castaic Lake Water Agency</i>													
Table A	0	1,595	2,870	3,007	4,862	5,149	3,770	3,619	2,979	1,970	1,291	1,238	32,350
Article 56(c) carryover	2,569	0	0	0	0	0	0	0	0	0	0	0	2,569
General Conveyance	0	0	0	0	0	0	2,000	2,000	2,000	2,000	2,000	1,000	11,000
Agency Total	2,569	1,595	2,870	3,007	4,862	5,149	5,770	5,619	4,979	3,970	3,291	2,238	45,919
<i>Coachella Valley Water District</i>													
Table A	0	922	0	0	0	0	5,133	13,321	13,321	13,321	13,321	13,321	72,660
Pool A	0	0	568	0	0	0	0	0	0	0	0	0	568
Agency Total	0	922	568	0	0	0	5,133	13,321	13,321	13,321	13,321	13,321	73,228
<i>Crestline-Lake Arrowhead Water Agency</i>													
Table A	130	0	71	103	165	226	225	198	218	164	164	104	1,768
Table A Transfer from San Bernardino Valley MWD	0	0	0	0	33	48	110	145	102	116	102	54	710
Local	0	83	40	0	0	0	0	0	0	0	0	2	125
Agency Total	130	83	111	103	198	274	335	343	320	280	266	160	2,603
<i>Desert Water Agency</i>													
Table A	0	380	0	0	0	0	2,120	5,500	5,500	5,500	5,500	5,500	30,000
Pool A	0	0	234	0	0	0	0	0	0	0	0	0	234
Agency Total	0	380	234	0	0	0	2,120	5,500	5,500	5,500	5,500	5,500	30,234

**Table 9-4 Total Amounts of Water Delivered in 2007, by Month (Acre-Feet)**

Contracting Agency and Type of Service	2007												
	Jan	Feb	Mar	Apr	May	June	July	Aug	Sept	Oct	Nov	Dec	Total Deliveries
Littlerock Creek Irrigation District													
Table A Exchange to AVEK*	0	0	0	0	0	0	0	0	0	0	0	1,380	1,380
Metropolitan Water District of Southern California													
Table A	0	0	18,610	155,645	166,016	166,452	176,046	137,826	85,730	73,175	59,101	8,445	1,047,046
Table A Flexible Storage Payback	0	0	0	99,854	0	0	0	0	0	0	0	0	99,854
Table A Transfer from San Bernardino Valley MWD	0	20,000	10,000	0	0	0	0	0	0	0	0	0	30,000
Pool A	0	0	8,962	0	0	0	0	0	0	0	0	0	8,962
Article 56(c) carryover	28,098	0	0	0	0	0	0	0	0	0	0	0	28,098
Article 21	85,636	47,790	31,210	0	0	0	0	0	0	0	0	0	164,636
Article 21 to Kern Water Bank*	745	1,136	0	0	0	0	0	0	0	0	0	0	1,881
Recovery from Arvin-Edison Water Bank	0	0	2,540	1,254	598	485	500	701	1,531	5,092	5,893	5,631	24,225
Recovery from Kern-Delta Water Bank	0	0	0	0	0	0	0	0	2,500	1,250	1,250	0	5,000
Recovery from Mojave Water Bank	0	0	0	0	3,250	3,250	3,250	3,250	3,250	3,250	3,250	3,250	26,000
Recovery from Semitropic Bank	0	0	0	0	0	0	0	0	13,047	20,016	29,946	30,977	93,986
Flexible Withdrawal from Castaic Lake	0	28,352	55,665	0	0	0	0	0	0	0	0	15,350	99,367
Flexible Withdrawal from Lake Perris	0	0	15,837	0	0	0	0	0	0	0	0	0	15,837
Agency Total (*excluded from total)	113,734	96,142	142,824	156,899	169,864	170,187	179,796	141,777	106,058	102,783	99,440	63,653	1,543,157
Mojave Water Agency													
Table A	0	167	3,190	1,107	896	800	651	688	3,831	2,642	1,603	2,657	18,232
Table A POD through AVEK*	0	39	73	75	160	151	194	140	133	107	50	18	1,140
Article 56(c) extended carryover	701	0	0	0	0	0	0	0	0	0	0	0	701
Article 56(c) carryover POD through AVEK*	36	0	0	0	0	0	0	0	0	0	0	0	36
Agency Total (*excluded from total)	701	167	3,190	1,107	896	800	651	688	3,831	2,642	1,603	2,657	18,933
Palmdale Water District													
Table A	0	256	896	1,642	1,676	2,236	2,583	2,756	735	0	0	0	12,780
Table A Exchange from AVEK	0	0	0	0	210	210	0	0	0	0	0	0	420
Pool A	0	0	0	0	0	0	100	0	0	0	0	0	100
Article 56(c) carryover	985	0	0	0	0	0	0	0	0	0	0	0	985
Article 21	0	504	339	0	0	0	0	0	0	0	0	0	843
General Conveyance	0	0	0	0	0	0	0	0	1,359	1,710	1,335	522	4,926
Agency Total	985	760	1,235	1,642	1,886	2,446	2,683	2,756	2,094	1,710	1,335	522	20,054

**Table 9-4 Total Amounts of Water Delivered in 2007, by Month (Acre-Feet)**

Contracting Agency and Type of Service	Jan	Feb	Mar	Apr	May	June	July	Aug	Sept	Oct	Nov	Dec	2007
													Total Deliveries
San Bernardino Valley Municipal Water District													
Table A	916	963	2,029	1,689	2,706	1,575	2,543	2,682	2,875	2,785	2,849	2,794	26,406
Table A Transfer to CLAWA *	0	0	0	0	33	48	110	145	102	116	102	54	710
Table A Transfer to MWDSC*	0	20,000	10,000	0	0	0	0	0	0	0	0	0	30,000
Article 56(c) carryover													
Agency Total (*excluded from total)	916	963	2,029	1,689	2,706	1,575	2,543	2,682	2,875	2,785	2,849	2,794	26,406
San Gabriel Valley Municipal Water District													
Table A	0	2	0	0	907	2,925	190	0	0	0	0	0	4,024
Table A Exchange to Dudley Ridge*	0	0	0	0	0	2,000	2,000	1,976	0	0	0	0	5,976
Pool A sale*	0	7,280	0	0	0	0	0	0	0	0	0	0	7,280
Agency Total (*excluded from total)	0	2	0	0	907	2,925	190	0	0	0	0	0	4,024
San Geronio Pass Water Agency													
Table A	792	584	743	447	626	123	0	0	0	91	603	0	4,009
Ventura County Watershed Protection District													
Table A	0	0	0	124	124	124	124	124	124	124	2,012	120	3,000
Pool A sale*	0	9,000	0	0	0	0	0	0	0	0	0	0	9,000
Agency Total (*excluded from total)	0	0	0	124	124	124	124	124	124	124	2,012	120	3,000
Recreation/Fish and Wildlife (SWP)													
Castaic Lagoon	12	10	10	21	23	26	20	22	19	20	2	11	196
Castaic Lake	0	0	0	0	0	0	0	0	0	0	0	0	0
Lake Perris	141	141	141	141	141	141	141	141	141	141	141	141	1,692
Pyramid Lake	0	0	0	0	1	1	1	1	0	0	0	2	6
Silverwood Lake	3	1	6	10	13	12	16	16	12	10	3	1	103
Agency Total	156	152	157	172	178	180	178	180	172	171	146	155	1,997
SWP													
SWP	124,383	105,407	160,107	172,084	190,609	193,913	209,148	182,237	144,589	134,808	129,978	91,209	1,838,472
Non-SWP	0	83	40	0	0	0	2,000	2,000	3,359	3,710	3,335	1,524	16,051
<b>Southern California Area Total</b>	<b>124,383</b>	<b>105,490</b>	<b>160,147</b>	<b>172,084</b>	<b>190,609</b>	<b>193,913</b>	<b>211,148</b>	<b>184,237</b>	<b>147,948</b>	<b>138,518</b>	<b>133,313</b>	<b>92,733</b>	<b>1,854,523</b>
<b>SWP WATER</b>													
<i>SWP Long Term Water Supply Contracts</i>													
Table A	2,303	14,986	84,479	201,598	261,604	325,462	340,086	259,025	151,049	119,318	101,347	44,453	1,905,710
Transfer Table A	0	20,000	10,000	0	2,533	1,348	6,715	12,359	102	856	102	54	54,069
Exchange Table A	0	0	0	0	210	4,210	2,000	1,976	520	0	0	1,380	10,296
Pool A	0	0	9,764	0	0	197	1,436	4,707	269	0	0	7	16,380
Article 12(e) carryover	820	0	0	0	0	0	0	0	0	0	0	0	820

**Table 9-4 Total Amounts of Water Delivered in 2007, by Month (Acre-Feet)**

Contracting Agency and Type of Service	2007												
	Jan	Feb	Mar	Apr	May	June	July	Aug	Sept	Oct	Nov	Dec	Total Deliveries
Article 56(C) carryover	93,942	0	0	0	0	0	0	0	0	0	0	0	93,942
Article 21	166,366	81,762	54,377	1,429	5,677	0	0	0	0	0	0	362	309,973
Water Bank Recovery	0	0	3,035	2,954	11,202	8,849	3,750	3,951	25,621	30,665	45,033	44,891	179,951
Flexible Storage Withdrawal	0	28,352	71,502	0	0	0	0	0	0	0	0	15,350	115,204
Agency Total	263,431	145,100	233,157	205,981	281,226	340,066	353,987	282,018	177,561	150,839	146,482	106,497	2,686,345
Other Water Supply Contracts													
Solano Settlement	0	0	0	1,286	0	0	0	0	3,427	2,202	2,654	999	10,568
Recreation/Fish and Wildlife	232	200	207	217	229	246	250	267	203	186	170	174	2,581
<b>SWP Total</b>	<b>263,663</b>	<b>145,300</b>	<b>233,364</b>	<b>207,484</b>	<b>281,455</b>	<b>340,312</b>	<b>354,237</b>	<b>282,285</b>	<b>181,191</b>	<b>153,227</b>	<b>149,306</b>	<b>107,670</b>	<b>2,699,494</b>
<b>NON-SWP WATER</b>													
Non-SWP Water Supply Contracts													
Local	55,231	2,738	5,975	68,844	201,808	193,842	204,326	148,385	61,255	75,219	131,458	86,828	1,235,909
Vallejo Permit	0	100	99	197	100	100	1,895	2,943	2,597	1,738	1,473	559	11,801
Subtotal	55,231	2,838	6,074	69,041	201,908	193,942	206,221	151,328	63,852	76,957	132,931	87,387	1,247,710
<b>CVP/Reclamation</b>													
Water transfer to SWP contractor	0	0	0	0	0	0	7,923	8,506	1,000	4,100	0	0	21,529
Annual Contract	30	33	38	36	46	46	16	26	36	75	47	38	467
Conveyance	0	9,867	0	0	0	0	2,000	2,000	3,459	3,710	3,335	1,522	25,893
Cross Valley Canal Contractors	0	0	0	0	0	0	10,773	24,311	13,637	0	0	0	48,721
Kern National Wildlife Refuge	1,020	806	0	305	500	200	0	2,050	3,470	4,104	2,974	2,097	17,526
Recreation/Fish and Wildlife	55	40	40	33	22	38	38	54	10	1	13	12	356
Subtotal	1,105	10,746	78	374	568	284	20,750	36,947	21,612	11,990	6,369	3,669	114,492
<b>Non-SWP Total</b>	<b>56,336</b>	<b>13,584</b>	<b>6,152</b>	<b>69,415</b>	<b>202,476</b>	<b>194,226</b>	<b>226,971</b>	<b>188,275</b>	<b>85,464</b>	<b>88,947</b>	<b>139,300</b>	<b>91,056</b>	<b>1,362,202</b>
<b>Grand Total</b>	<b>319,999</b>	<b>158,884</b>	<b>239,516</b>	<b>276,899</b>	<b>483,931</b>	<b>534,538</b>	<b>581,208</b>	<b>470,560</b>	<b>266,655</b>	<b>242,174</b>	<b>288,606</b>	<b>198,726</b>	<b>4,061,696</b>

**Table 9-5 Total Amounts of Annual Table A Water and Water Conveyed, by Type, 1962-2007 (Acre-Feet)<sup>e</sup>**

Year	Annual Table Amounts According to Long-Term Water Supply Contracts							Water Conveyed							Total (16)	
	Deliveries							Deliveries								
	Upper Feather River Area (1)	North Bay Area (2)	South Bay Area (3)	San Joaquin Valley Area (4)	Central Coastal Area (5)	Southern California Area (6)	Total (7)	Table A Water (8)	Article 21, Surplus, and Unscheduled Water <sup>a</sup> (9)	Other Water <sup>b</sup> (10)	Feather River Diversions <sup>c</sup> (11)	Wildlife/Recreation Water (12)	Subtotal (13)	Initial Fill Water (14)		Losses and Storage Changes <sup>d</sup> (15)
1962	0	0	0	0	0	0	0	0	0	18,289	0	0	18,289	9	272	18,570
1963	0	0	0	0	0	0	0	0	0	22,456	0	0	22,456	71	185	22,712
1964	0	0	0	0	0	0	0	0	0	32,507	0	0	32,507	171	152	32,830
1965	0	0	0	0	0	0	0	0	0	44,105	0	0	44,105	93	729	44,927
1966	0	0	0	0	0	0	0	0	0	67,928	0	0	67,928	0	1,746	69,674
1967	0	0	11,538	0	0	0	11,538	11,354	0	53,605	0	0	64,959	8,328	4,212	77,499
1968	550	0	109,900	77,350	0	3,700	191,500	171,709	121,534	14,777	866,926	0	1,174,946	498,926	117,906	1,791,778
1969	620	0	98,700	163,075	0	5,000	267,395	193,020	72,397	18,829	794,374	0	1,078,620	510,614	72,196	1,661,430
1970	700	0	114,200	202,000	0	5,700	322,600	233,993	133,024	38,080	759,759	0	1,164,856	23,947	2,435	1,191,238
1971	890	0	116,200	251,800	0	6,700	375,590	357,340	296,019	44,119	778,362	8	1,475,948	7,853	5,812	1,489,513
1972	970	0	118,300	413,066	0	209,423	741,759	611,801	423,964	66,638	817,398	6,489	1,926,290	100,274	53,062	2,079,626
1973	1,100	0	120,400	383,652	0	481,100	986,252	692,888	296,416	42,511	800,743	1,155	1,833,713	204,638	53,798	2,092,149
1974	1,230	0	122,400	460,650	0	597,920	1,182,200	874,075	417,676	46,224	911,613	2,118	2,251,708	237,554	10,657	2,499,917
1975	1,610	0	124,500	545,809	0	714,950	1,386,869	1,223,990	622,902	63,793	862,218	3,377	2,776,280	103,352	(94,606)	2,785,026
1976	1,990	0	126,500	543,417	0	836,480	1,508,387	1,373,002	580,110	115,217	946,440	1,745	3,016,514	61,122	(681,025)	2,396,611
1977	2,420	0	128,600	581,400	0	954,901	1,667,321	573,896	0	389,065	581,994	1,111	1,546,066	0	(131,151)	1,414,915
1978	1,850	0	130,700	635,900	0	1,049,584	1,818,034	1,312,365	16,914	121,225	786,517	1,691	2,238,712	64,443	717,370	3,020,525
1979	2,130	0	132,700	702,685	0	1,190,573	2,028,088	1,404,292	648,389	187,630	882,549	1,766	3,124,626	12,302	(83,430)	3,053,498
1980	1,810	500	134,800	758,100	1,946	1,317,614	2,214,770	1,511,491	404,557	46,459	875,045	2,131	2,839,683	0	(26,606)	2,813,077
1981	1,940	650	137,000	818,000	2,813	1,432,065	2,392,468	1,889,125	908,428	279,161	838,557	4,688	3,919,959	0	(802,263)	3,117,696
1982	1,970	800	139,200	876,500	5,626	1,550,449	2,574,545	1,738,056	215,873	154,882	776,330	4,646	2,889,787	0	480,752	3,370,539
1983	2,000	950	141,400	867,118	8,439	1,681,257	2,701,164	1,184,119	13,019	181,453	602,905	7,849	1,989,345	0	(90,997)	1,898,348
1984	3,630	1,100	143,600	979,211	12,698	1,744,098	2,884,337	1,587,593	262,917	381,024	832,332	7,040	3,070,906	0	(140,182)	2,930,724
1985	3,760	1,250	145,800	1,019,049	21,138	1,864,849	3,055,846	1,912,765	307,672	404,842	870,008	4,033	3,499,320	0	92,885	3,592,205
1986	4,190	1,400	148,100	1,091,946	28,210	1,983,890	3,257,736	2,007,906	36,620	193,606	791,737	3,865	3,033,734	0	284,380	3,318,114
1987	4,620	1,550	150,300	1,188,500	35,204	2,103,941	3,484,115	2,113,915	114,907	377,592	831,947	7,672	3,446,033	0	(390,413)	3,055,620
1988	5,060	15,471	152,500	1,246,100	43,722	2,225,482	3,688,335	2,276,373	0	507,076	794,834	4,889	3,683,172	0	(92,850)	3,590,322
1989	5,500	24,615	156,700	1,290,400	56,342	2,424,633	3,958,190	2,853,747	0	474,559	830,500	8,135	4,166,941	0	447,917	4,614,858
1990	6,040	28,190	160,900	1,313,450	70,486	2,500,600	4,079,666	2,582,151	90	424,697	875,099	9,262	3,891,299	0	(528,869)	3,362,430
1991	11,880	29,590	166,400	1,338,011	70,486	2,510,200	4,126,567	549,113	3,521	551,051	565,395	4,879	1,673,959	0	167,435	1,841,394

**Table 9-5 Total Amounts of Annual Table A Water and Water Conveyed, by Type, 1962-2007 (Acre-Feet)<sup>c</sup> (continued)**

Year	Annual Table Amounts According to Long-Term Water Supply Contracts							Water Conveyed							Total (16)	
	Upper Feather River Area (1)	North Bay Area (2)	South Bay Area (3)	San Joaquin Valley Area (4)	Central Coastal Area (5)	Southern California Area (6)	Total (7)	Deliveries								
								Table A Water (8)	Article 21, Surplus, and Unscheduled Water <sup>a</sup> (9)	Other Water <sup>b</sup> (10)	Feather River Diversions <sup>c</sup> (11)	Wildlife/Recreation Water (12)	Subtotal (13)	Initial Fill Water (14)		Losses and Storage Changes <sup>d</sup> (15)
1992	11,920	32,010	171,900	1,342,300	70,486	2,510,200	41,38816	1,410,799	1,156	144,789	613,978	2,605	2,233,982	0	(63,541)	2,109,786
1993	11,960	34,620	177,400	1,342,300	70,486	2,510,200	41,46966	2,313,236	0	254,854	822,589	2,609	3,395,287	0	726,123	4,119,411
1994	12,000	37,215	182,000	1,342,300	70,486	2,510,200	41,54201	1,749,351	112,625	236,739	874,018	8,200	2,980,933	0	(295,405)	2,685,528
1995	12,050	44,030	184,000	1,342,300	70,486	2,510,200	41,163066	1,967,093	64,330	78,425	860,077	2,575	2,972,500	0	69,536	3,042,036
1996	12,100	48,225	186,000	1,301,630	70,486	2,492,900	41,11341	2,514,825	28,647	251,391	934,997	3,907	3,733,767	86	491,550	4,225,402
1997	12,150	49,315	188,000	1,297,300	45,201	2,492,900	4,084,866	2,226,083	21,432	322,000	993,211	4,146	3,601,172	527	(11,806)	3,589,893
1998	12,200	50,420	188,000	1,272,300	45,201	2,517,900	4,086,021	1,726,519	20,288	134,682	872,738	2,108	2,756,335	0	(132,491)	2,623,844
1999	12,250	51,500	188,000	1,272,300	70,486	2,519,900	4,114,436	2,738,903	158,070	85,312	1,108,672	4,324	4,095,281	0	(189,525)	3,905,756
2000	14,000	55,945	210,000	1,205,300	70,486	2,565,900	4,121,631	3,199,906	308,785	332,654	1,085,886	4,030	4,931,261	0	(20,103)	4,911,158
2001	14,670	66,561	220,000	1,185,519	70,486	2,566,900	4,124,136	1,534,263	43,435	477,835	1,078,656	2,929	3,137,118	0	159,983	3,297,101
2002	14,730	67,396	220,000	1,195,219	70,486	2,557,200	4,125,031	2,564,587	37,165	307,162	1,132,938	3,694	4,045,816	0	80,709	4,126,525
2003	14,790	68,231	220,400	1,194,819	70,486	2,558,200	4,126,926	2,890,215	59,828	251,447	1,008,093	2,846	4,212,429	0	459,377	4,671,806
2004	13,100	69,056	222,619	1,182,700	70,486	2,569,100	4,127,061	2,594,999	218,496	385,088	1,174,672	2,865	4,376,120	0	108,840	4,484,960
2005	10,800	69,481	222,619	1,170,000	70,486	2,582,300	4,125,686	2,826,210	731,083	96,932	1,074,706	1,506	4,730,437	0	529,347	5,259,784
2006	11,124	69,856	222,619	1,170,000	70,486	2,582,800	4,126,885	2,971,851	621,339	119,403	1,112,551	1,936	4,827,080	0	(119,981)	4,707,099
2007	11,520	70,231	222,619	1,170,000	70,486	2,584,450	4,129,306	2,081,217	309,973	449,935	1,217,990	2,581	4,061,696	0	(524,851)	3,536,845
<b>Total</b>	<b>269,824</b>	<b>990,158</b>	<b>6,457,514</b>	<b>37,733,476</b>	<b>1,434,316</b>	<b>70,026,359</b>	<b>116,911,647</b>	<b>68,684,705</b>	<b>8,633,601</b>	<b>9,292,048</b>	<b>35,239,354</b>	<b>141,410</b>	<b>117,929,422</b>	<b>1,834,310</b>	<b>1,244,122</b>	<b>121,007,854</b>

<sup>a</sup> Values include amounts of deliveries to short-term contractors (Mustang Water District, 1970-1972; Tracy Golf and Country Club 1974, 1979, and 1980; Green Valley Water District, 1974, 1975, 1978, 1979, 1980, and 1985; Granite Construction Company, 1980).

<sup>b</sup> Includes amounts of SWP and non-SWP water conveyed for SWP and non-SWP water contractors.

<sup>c</sup> Includes amounts of water diverted under various water rights agreements.

<sup>d</sup> Amounts reflect net effect of (1) operational losses from SWP transportation facilities; (2) changes in reservoir storage south of Delta; (3) storable local inflows to SWP reservoirs; (4) side inflow to San Luis Canal; and (5) inflow into California Aqueduct from Kern River Interlie.

<sup>e</sup> Note: values presented in this table reflect changes to historical delivery data as a result of an audit performed by DWR. These data supersede values presented in previous Bulletin 132 editions.



## **Chapter 10**

# **Power Resources**

*Sunset in the Sacramento-San Joaquin Delta.*



## Significant Events in 2007

**D**uring 2007, the California Independent System Operator (CAISO) continued work on proposals for a major redesign of its markets through the Market Redesign and Technology Upgrade (MRTU) tariff.

In January 2005, the Department of Water Resources (DWR) submitted its application for a new license for the Oroville Facilities with the Federal Energy Regulatory Commission (FERC). On February 1, 2007, FERC issued an annual license pending completion of the relicensing process. Environmental documentation and negotiations with stakeholders were ongoing in 2007.

*Information for this chapter was provided by the State Water Project Analysis Office, the SWP Power and Risk Office, and the Executive Division.*

**L**ong-term State Water Project (SWP) water contractors depend on the SWP to provide economical sources of power to deliver affordable water. Consequently, the Department of Water Resources (DWR) developed and administers a comprehensive power resources program. Key elements of the program include the strategic timing of generation and pumping schedules, purchase of power resources and transmission services, short-term sales of surplus power, and studies of power resources for future needs.

## Power Resources Program

The goals of the SWP power resources program are to:

- obtain reliable, environmentally sensitive, and competitively priced power resources and transmission services sufficient to operate the SWP;
- develop and manage power resources to minimize the cost of water deliveries to SWP water contractors;
- meet responsibilities and criteria of the Western Electricity Coordinating Council (WECC); and
- conform to regulations of the Federal Energy Regulatory Commission (FERC).

To achieve these goals, DWR constructed its own power facilities and enters into long-term contracts and short-term arrangements with other electric utilities and with the California Independent System Operator (CAISO) for transmission access and for power purchases and sales. DWR's generators and pumps also provide spinning and nonspinning reserves to the CAISO ancillary services markets. In addition, DWR's power resources program takes advantage of SWP water storage and conveyance capacities to control pump loads and generation in a cost-effective manner.

## Major Electric Utility Industry Developments

During 2007, CAISO continued refining the Market Redesign and Technology Upgrade (MRTU) tariff. At the same time, CAISO developed a post-MRTU initiatives road map to further reform the California electricity market.

In the area of renewable resources, the California Public Utilities Commission (CPUC), California Energy Commission, CAISO, and publicly owned utilities supervised the Renewable Energy Transmission Initiative to help identify transmission projects needed to accommodate renewable energy goals. These goals are primarily the result of California's Renewables Portfolio Standard, which requires electric corporations to increase procurement from eligible renewable energy resources by at least 1 percent of their retail sales annually, until they reach 20 percent by 2010.

## DWR Participation in Electric Utility Industry Activities

DWR continued to participate in CAISO's stakeholder processes to help ensure that MRTU tariff, CAISO Business Practice Manuals, and MRTU functional simulations are compatible with operations of wholesale market participants, including the SWP. DWR's participation in CAISO stakeholder

processes focused on the following primary elements:

- modeling, scheduling, and settling DWR's hydroelectric power facilities and power transactions;
- forecasting CAISO Locational Marginal Prices and participating in CAISO Congestion Revenue Rights allocation and auction processes;
- allocating Residual Unit Commitment costs;
- setting Start-up Cost and Minimum Load Cost bid caps;
- accommodating Use-Limited Resources for the CAISO market participation;
- mitigating energy bids for Exceptionally Dispatched resources;
- allocating CAISO Grid Management Charges to market participants; and
- initiating new market refinements, including Demand Response and Convergence Bidding.

DWR also participated in additional electric utility stakeholder processes and FERC proceedings to help ensure that various market requirements and cost allocation mechanisms were appropriately structured. Major processes and litigations in which DWR participated include the following (with FERC docket number given in parenthesis if applicable):

- San Diego Gas & Electric Company (SDG&E) 3rd transmission owner tariff filing to increase its wholesale Transmission Revenue Requirement (ER07-284);
- CAISO request for conceptual approval of a financing mechanism and rate treatment for facilities that interconnect Location Constrained Resources (EL07-33);
- Nevada Hydro Company filing for inclusion of its pump-storage cost into

CAISO transmission access charge (ER06-278);

- Pacific Gas & Electric Company (PG&E) 10th transmission owner tariff filing and existing transmission contracts rate filing (ER07-1213, ER07-267);
- PacifiCorp transmission agreement filing under which PacifiCorp leases to PG&E a 500 KV transmission line over a four-year window (ER07-882);
- PG&E filing to increase existing transmission contract rates under the Comprehensive Agreement with DWR (ER08-267);
- Southern California Edison (SCE) petition for declaratory order for incentive rate treatment (EL07-62);
- PG&E filing to FERC to continue revenue sharing on non-tariff products and services (ER07-91);
- CAISO filing of Transmission Rights and Transmission Curtailments that affect SWP scheduling priorities (ER06-615, ER07-613);
- CAISO Tariff Amendment 60 filing to allocate minimum load costs that are incurred in solving Inter-Zonal Congestions (EL04-103, ER04-835);
- CAISO filing to allocate ancillary service costs (ER06-615-006, ER06-615-012);
- DWR filing in recognition of DWR as a wholesale entity by California Air Resources Board for greenhouse gas emission reporting;
- California Energy Commission process for designating transmission corridors in California;
- CAISO filing to allocate Electric Reliability Organization cost to market participants (ER07-805-002, ER07-1304); and
- CAISO filing to exempt SWP Participating Load from underscheduling penalties (ER06-615-013).

DWR also participated in litigation before the Ninth Circuit Court and the D.C. Circuit Court on various electric utility matters when a

successful resolution was not reached before FERC. Litigation included:

- FERC No. 04-73161: treatment of certain PG&E interconnection facilities that connect generating plants to the transmission grid as transmission facilities and allocation of the related cost to ratepayers on a “rolled-in” systemwide basis;
- FERC No. 06-1179: treatment of certain transmission facilities that are included in the contracts between the transmission owners and the Cities of Anaheim and Riverside but that are not controlled by CAISO and allocation of the associated cost to CAISO ratepayers; and
- FERC No. 07-1222: application of Must Offer Obligations to Use-limited Resources including DWR’s hydroelectric power generators and pumps.

## Bulk Electric System Reliability Standards

### Background

The Energy Policy Act of 2005 gave FERC legal jurisdiction over the reliability of the Bulk Electric System in the United States. The North American Electric Reliability Corporation (NERC) was chosen by FERC as the Electric Reliability Organization (ERO) and is now empowered to oversee development of reliability standards and to assess the adequacy of the owners and users of the Bulk Electric System to operate in a reliable manner. Compliance with NERC reliability standards is mandatory. Noncompliance with any NERC reliability standard requirement can result in significant financial penalties and/or sanctions.

NERC has delegated enforcement of its reliability standard requirements to eight regional entities. In DWR’s region, the Western Electricity Coordinating Council (WECC) is the entity assessing and enforcing compliance with the reliability standards.

The standards developed by NERC fall under these categories:

- BAL—Resource and Demand Balancing;
- COM—Communications;
- CIP—Critical Infrastructure Protection;
- EOP—Emergency Preparedness and Operations;
- FAC—Facilities Design, Connections, and Maintenance;
- INT—Interchange Scheduling and Coordination;
- IRO—Interconnection Reliability Operations and Coordination;
- MOD—Modeling, Data, and Analysis;
- NUC—Nuclear;
- PER—Personnel Performance, Training, and Qualifications;
- PRC—Protection and Control;
- TOP—Transmission Operations;
- TPL—Transmission Planning; and
- VAR—Voltage and Reactive.

### NERC Reliability Compliance—Program Goals

DWR is committed to providing an effective reliability compliance program. In addition, DWR strives to achieve a culture of compliance that supports its key business objectives of safety and reliability.

DWR established its compliance program to ensure strict compliance with NERC’s mandatory reliability standards. These standards include specific impacts on operations, maintenance, physical security, and cyber security. The compliance program may perform program audits and reviews to ensure successful and ongoing compliance. Audits and reviews are done by the Governance side of the compliance program and include only staff that are independent of any responsibility for meeting the reliability standards. Consultants or contractors can be used for providing the objectivity that is required.

Compliance program attributes include:

- senior management involvement and support in fostering a culture of compliance as well as having a continuous role in participating, evaluating, and authorizing the program;
- DWR participation in industry groups that develop, review, approve, and implement reliability standards, North American Energy Standards Board (NAESB) business practice standards, and WECC regional criteria and guidelines;
- identification of employees, designated as Business Owners and Subject Matter Experts, who have responsibility, authority, and accountability for compliance with the reliability standards;
- employee training as required to adhere to the requirements of the reliability standards and to foster support and awareness of the compliance program and employee responsibilities;
- encouraging internal communication along with an easy mechanism to alert program staff to any issues that have caused, or are likely to cause, DWR to be potentially noncompliant with the standards; and
- responsiveness in addressing, correcting, or mitigating issues identified during the development and implementation of the compliance program.

### ***DWR's Responsibility***

All owners, operators, and users of the Bulk Electric System must formally register with NERC and fully comply with all applicable reliability standards and associated requirements. DWR is currently registered with NERC for 4 of 15 functional areas as follows:

- Transmission Owner (TO);
- Load Serving Entity (LSE);
- Generation Owner (GO); and
- Generation Operator (GOP).

DWR organizations that are responsible for the registered functional areas reside within the following offices:

- Plant Asset Management Office;
- State Water Project Operations Control Office;
- Power Planning and Contract Management Office;
- Field Division Offices; and
- Operations Support Office.

All management and staff in these organizations are required to support DWR's compliance efforts.

DWR has initiated the work required to meet the compliance requirements of the reliability standards. The first self-certification is due in January 2008 involving operations, maintenance and engineering functions. This process requires DWR to certify that it is currently in compliance with the requirements of each standard or provide a violation report supported by a mitigation plan to resolve outstanding items. Violations may lead to financial penalties or reduced operating flexibility.

### **Oroville Facilities Relicensing**

On January 26, 2005, DWR submitted an application to FERC requesting a new license for the Oroville Facilities (FERC Project Number 2100). The existing 50-year term hydropower license expired January 31, 2007, and, until the new license is issued, FERC is issuing annual licenses.

In September 2005, FERC accepted DWR's application for a new license; and in March 2006, DWR concluded settlement negotiations with a wide array of interests. The final Settlement Agreement was filed the same month.

On May 18, 2007, FERC issued the final environmental impact statement (EIS) for the Oroville facilities. On July 6, 2007,

DWR submitted the combined biological assessment and essential fish habitat assessment to the National Marine Fisheries Service (NOAA Fisheries). These assessments evaluated the effects of the proposed project on the federally listed anadromous fish species and their designated critical habitats protected under the federal Endangered Species Act (ESA).

Negotiations among DWR, PG&E, and various stakeholders on the *Habitat Expansion Agreement for Central Valley Spring-Run Chinook Salmon and California Central Valley Steelhead: FERC Project Nos. 1962, 2100, 2105, and 2107* (HEA) were concluded in November 2007, and the parties signed the habitat expansion agreement. However, negotiations with Native American tribes continued, as well as negotiations between DWR and Butte County to address socioeconomic issues, and negotiations between DWR and Feather River Service Area water users to address water temperature contractual issues. Discussions continued with appropriate parties regarding the development of a historic properties management plan and an associated programmatic agreement. DWR circulated the draft environmental impact report (EIR) in 2007 and received numerous comments from agencies and stakeholders. It continued with preparation of the final EIR and responses to comments.

The HEA is available at <http://www.sac-basin-hea.com>.

During 2007, primary achievements included:

- completion of the reconnaissance study for potential facilities modification(s) for fish habitat temperature needs;
- FERC's issuance of a Notice of Authorization for Continued Project Operation while the relicensing process continues;
- filing of responses to comments submitted by interveners on the draft EIS;

- completion of the final biological opinion by the U.S. Fish and Wildlife Service (USFWS) on wildlife and non-anadromous fish species;
- completion of the National Environmental Policy Act (NEPA) final EIS by FERC containing evaluations on DWR's proposal and alternatives for licensing the Oroville facilities;
- withdrawing and resubmitting the application for Section 401 water quality certification with the State Water Resources Control Board (SWRCB), thereby reinitiating the one-year clock for SWRCB to take action;
- issuance of a notice of completion and availability of the draft EIR and notice of public meeting for relicensing of the Oroville facilities;
- submission of the revised biological assessment for federally listed anadromous fishes;
- conducting of a public meeting on the draft EIR for the Oroville facilities relicensing;
- submission of comments to FERC on the final EIS for the Oroville facilities relicensing; and
- submission to FERC of the approved copy of the HEA.

As an interim settlement activity, DWR agreed to provide \$3 million to the Feather River Recreation and Park District to fund recreation improvements at Riverbend Park in Oroville through calendar year 2007. An additional \$2.2 million was added via a contract amendment with approval of the original signatories to the interim settlement agreement for Riverbend Park improvements. These funds count towards the total committed as part of the Supplemental Benefits Fund created by the Oroville Facilities Relicensing Settlement Agreement.

The following is a partial list of SWP facilities that will be subject to the new license terms and conditions:

- Oroville Dam and Reservoir;
- Hyatt Pumping-Generating Plant;
- Thermalito Pumping-Generating Plant;
- Thermalito Diversion Dam Powerplant;
- Thermalito Diversion Dam;
- Fish Barrier Dam;
- Feather River Fish Hatchery;
- Thermalito Power Canal;
- Thermalito Forebay; and
- Thermalito Afterbay.

### Existing SWP Power Facilities

Figure 10-1 shows the names, locations, and nameplate capacities of DWR's primary power facilities.

#### Hydroelectric

Economic hydroelectric generation provides the largest share of SWP power resources. The combined Hyatt Pumping-Generating Plant and Thermalito Pumping-Generating Plant (Hyatt-Thermalito) generate about 2.2 billion kilowatt hours (kWh) of energy in a median water year, while the 3 megawatts (MW) from Thermalito Diversion Dam Powerplant adds another 24 million kWh per year.

Generation at California Aqueduct recovery plants—Alamo, Devil Canyon, Gianelli, Mojave Siphon, and Warne—varies with the amount of water conveyed. These five plants generate about one-sixth of the total energy used by the SWP.

#### Coal

Since July 1983, under the "Participation Agreement Reid Gardner Unit No. 4" between DWR and Nevada Power Company (NPC), DWR has received energy from Reid Gardner Powerplant, a coal-fired facility in Nevada. Reid Gardner Powerplant consists of

four units. DWR owns 67.8 percent of Unit 4, and NPC owns the remainder of Unit 4 as well as all of Units 1, 2, and 3. Under the agreement, DWR receives up to 235 MW from Unit 4, subject to NPC's limited right to interrupt DWR's energy deliveries. Whenever NPC interrupts DWR's scheduled energy, DWR receives payment based on NPC's combustion turbine costs.

In 2007, NPC entered into a consent decree with the U.S. Environmental Protection Agency and the State of Nevada to settle disputes related to opacity and emission reporting requirements at the Reid Gardner Powerplant. As a result of the consent decree, NPC installed pollution control equipment, paid penalties, and agreed to comply with various reporting requirements. The Reid Gardner agreement expires in 2013 and will not be renewed.

### Future SWP Power Facilities

To meet future SWP power requirements, DWR evaluates new power and transmission resources. Factors considered include:

- anticipated power requirements for pumping;
- transmission access;
- anticipated water deliveries to contractors;
- cost of the resource;
- availability and cost of financing;
- environmental impacts and costs of mitigation; and
- operating characteristics.

In addition, DWR is considering several potential power resources at existing plants, including a second unit at Alamo Powerplant and a third unit at Warne Powerplant.

### Contractual Resource Arrangements

Through joint developments, exchanges, and purchases, DWR obtains a significant amount of capacity and energy for SWP operations



**Figure 10-1 Names, Locations, and Nameplate Capacities of Primary Power Facilities**



from other utilities throughout California, the Northwest, and the Southwest. Under these agreements, DWR can sell, buy, or exchange energy on an hourly to multiyear basis, as needed.

### **Joint Developments**

In 1966, DWR entered into a contract with the Los Angeles Department of Water and Power (LADWP) for joint development of the West Branch of the California Aqueduct. LADWP constructed and operates Castaic Powerplant, which is connected to the LADWP transmission system at the Sylmar Substation. DWR receives capacity and energy at the Sylmar Substation based on weekly water schedules through the West Branch.

Gianelli Pumping-Generating Plant is a joint project between DWR and the U.S. Bureau of Reclamation (Reclamation). DWR's share of the facility is 222 MW, and Reclamation's share is 202 MW.

### **Purchases**

DWR obtains a significant amount of energy through long-term and short-term purchase agreements.

**Long-Term Purchase Agreements.** The output of the 165 MW hydroelectric Pine Flat Powerplant, owned and operated by Kings River Conservation District, supplies the SWP with about 400 million kWh of energy in median water years. DWR also contracts for the energy output of five hydroelectric plants totaling 30 MW owned and operated by Metropolitan Water District of Southern California (Metropolitan).

**Short-Term Purchase Agreements.** DWR also purchases energy from member utilities and energy marketers of the Western Systems Power Pool, which changed its name to WSPP in May 2007. In addition to the standard WSPP transactions, DWR can also purchase surplus energy from Metropolitan's

Colorado River Aqueduct system according to the terms of the 1988 Coordination Agreement between DWR and Metropolitan. This agreement also provides for monthly surplus firm and economy energy sales from DWR to Metropolitan and energy exchanges between DWR and Metropolitan.

### **Energy Exchanges**

Under an energy exchange agreement with Sacramento Municipal Utility District (SMUD), DWR provides SMUD with energy during peak periods from May through September. In return, SMUD provides DWR with energy during off-peak periods from January through March and from September through December.

### **Load Management**

DWR operates its pumps through an extensive computerized network. This control system allows DWR to minimize the cost of power it purchases by maximizing pumping during off-peak periods when power costs are lower—usually at night—and selling power to other utilities and energy marketers during on-peak periods when power costs are higher. By taking advantage of this scheduling flexibility, whenever not restricted by operating requirements, SWP pump load and generation are optimized to reduce the net cost of power needed for SWP water deliveries.

### **Sales or Exchanges of Excess Power**

When generation from SWP power resources exceeds requirements, DWR sells or exchanges the excess power through contracts with utilities and marketers.

### **Demand Response**

Through the demand reserves contract administered by the California Energy Resource Scheduling Division of DWR, DWR reduces demand on the CAISO electric grid by dropping SWP pump load when called upon.

## Contractual Transmission Agreements

Although able to acquire transmission independently, DWR depends on other sources for transmission services. PG&E, CAISO, and SCE are the primary providers of transmission service between SWP power resources and pumping loads and also with interconnected utilities for power purchases, sales, and exchanges.

Under the Comprehensive Agreement with PG&E, DWR receives 1,300 MW of firm transmission service over the PG&E transmission system to serve SWP pump loads and power resources in Northern and Central California.

In Southern California, DWR receives transmission service for SWP loads and resources through CAISO. Additionally, DWR has interconnection and wholesale distribution service agreements with SCE for service over SCE's distribution facilities from the CAISO interchange points to SWP loads and resources.

Under the Participation Agreement with NPC, DWR receives 235 MW of firm transmission service over NPC's transmission system between Reid Gardner Unit 4 and the El Dorado Substation. Under the Firm Transmission Service Agreement between SCE and DWR, DWR receives 235 MW of firm transmission service over SCE's transmission system between the El Dorado Substation and the Vincent Substation.

## SWP Power Operation in 2007

Tables 10-1 through 10-4, at the end of this chapter, present historical information about SWP power operation for calendar year 2007, including energy consumed, generated, exchanged, purchased, and sold.

## Energy Consumed

In 2007, energy used at the 28 SWP pumping and generating plants totaled 9.77 million megawatt hours (MWh). According to the terms and conditions of various water conveyance contracts and exchange agreements, some water belonging to the Central Valley Project (CVP) is pumped through Banks and Dos Amigos Pumping Plants and Gianelli Pumping-Generating Plant. Reclamation furnishes additional energy for this purpose.

Table 10-1 shows the amount of energy used each month at SWP pumping and power generating plants to operate the SWP in 2007, excluding transmission losses.

## Energy Generated

Table 10-2 shows the amounts of energy generated at SWP facilities in 2007, as well as energy purchased for SWP operations.

### Hydroelectric and Coal

The Hyatt-Thermalito power complex in Oroville generated 2.08 million MWh of energy in 2007.

Energy generated at SWP aqueduct recovery plants—Gianelli, Alamo, Devil Canyon, Mojave Siphon, and Warne—totaled 1.99 million MWh.

The SWP share of energy generated at the coal-fired Reid Gardner Unit 4 in Nevada totaled 1.52 million MWh.

## Contractual Resource Arrangements

SWP power operations rely on contractual arrangements as well as SWP facilities. These contractual arrangements include joint development projects, energy exchanges, and energy purchases.

### **Joint Developments**

Through the West Branch Cooperative Development Agreement with LADWP, DWR receives energy based on the amount of water scheduled through the West Branch. In 2007, LADWP provided 850,513 MWh for DWR's share of energy generated at Castaic Powerplant.

DWR's share of Gianelli Pumping-Generating Plant used 183,589 MWh and generated 245,677 MWh of energy.

### **Energy Exchanges**

As detailed previously in this chapter, DWR exchanged energy with SMUD in 2007 under the terms of an existing energy exchange agreement.

### **Purchases and Costs**

Table 10-3 shows amounts of power, transmission, and other services purchased in 2007 and the costs of purchases, by area. Amounts shown include short-term and long-term purchases. It also reflects the restructuring of the electric industry through transactions with CAISO and through new charges (grid management and ancillary services charges).

DWR purchased 4.97 million MWh of energy at a cost of \$263.67 million. Other SWP power costs, including transmission, operation, maintenance, and CAISO ancillary services totaled \$135.73 million. This amount includes \$4.94 million for debt service and \$5.54 million for operations and maintenance costs at Pine Flat Powerplant. It also includes \$1.78 million for transmission at Reid Gardner Unit 4 and \$62.24 million for costs associated with operations and maintenance, fuel, insurance, and property taxes at Reid Gardner Unit 4.

**Long-Term Purchase Agreements.** According to the terms of the Kings River Conservation District contract, DWR receives the total

output of the 165 MW Pine Flat Powerplant. In 2007, the power plant provided 194,813 MWh of energy to the SWP at a total cost of \$1.56 million.

Under the Metropolitan Small Hydro contract, DWR purchased 145,142 MWh of energy in 2007 from five small hydroelectric power plants on the Metropolitan system at a cost of \$8.24 million.

**Short-Term Purchase Agreements.** Existing resources and long-term power and transmission contracts ensure that the SWP has enough power to meet long-term needs. When SWP power requirements exceed resources during daily operations, short-term purchases make up the difference. In 2007, the SWP purchased short-term energy from 24 marketers, in addition to 12 public electric utilities.

### **Sales of Excess Power**

DWR sold 2.26 million MWh of energy to 20 utilities and 22 power marketers for total revenues of \$138.89 million in 2007. DWR also received \$40.43 million in revenues for capacity, exchanges, and other energy-related services, including \$24.35 million for transactions made through CAISO. See Table 10-4 for information about energy and other services sold and revenue received, including those sold to CAISO.

### **Forecasting Power Operations**

DWR bases its forecast of power operations primarily on the amount of energy necessary to deliver approved Table A water requested by water contractors.

Each year, after reviewing the water contractors' water delivery requests and the construction schedule for future facilities, DWR forecasts the associated energy consumption and generation through 2035.

Short-term power requirements, based on actual water supply and reservoir storage levels, are determined for the current and two ensuing years of operation. Long-term operational studies for the remaining years are based on median-year water supply conditions and optimal reservoir storage levels. The forecast also includes losses in reservoirs and aqueducts, recreation water, and water to replace storage in reservoirs south of the Delta.

Actual SWP power requirements may vary significantly from the forecast amounts. Those variations are due to the amount of water available and delivered in a given year. For example, dry conditions in Northern California could result in a reduction in the amount of water available for delivery and for generation. If full deliveries could not be made, less power would be used. Power requirements could also decrease during a wet year because of the availability of local water in the San Joaquin Valley or Southern California.

Conversely, power requirements could exceed the amount originally forecast if actual water deliveries are greater than the amounts estimated. For example, if additional pumping is needed to refill reservoirs south of the Delta after an unexpectedly dry year, then more power would be used.

**Table 10-1 Energy Used at Pumping Plants and Power Plants in 2007, by Month (Millions of Kilowatt-Hours)**

Pumping Plants and Power Plants	Jan	Feb	Mar	Apr	May	Jun	Jul	Aug	Sept	Oct	Nov	Dec	Total
Hyatt-Thermalito Pumping-Generating Plant (pumpback and station service)	0.160	0.133	10.251	0.000	0.215	0.254	0.622	0.056	1.089	0.036	0.082	0.113	13.011
North Bay Interim Pumping Plant	0.000	0.000	0.000	0.000	0.000	0.000	0.000	0.000	0.000	0.000	0.000	0.000	0.000
Cordelia Pumping Plant	1.018	0.848	0.633	0.976	1.262	1.284	1.518	1.531	1.435	0.977	1.123	0.917	13.522
Barker Slough Pumping Plant	0.606	0.459	0.338	0.583	1.279	1.575	2.024	1.894	1.621	0.916	1.078	0.533	12.906
South Bay Pumping Plant	8.913	2.626	12.274	13.601	14.222	6.263	15.101	15.529	10.599	9.514	10.943	8.723	128.307
Del Valle Pumping Plant	0.022	0.018	0.266	0.532	0.317	0.031	0.029	0.015	0.015	0.020	0.024	0.028	1.315
Banks Pumping Plant	60.131	39.773	52.278	34.646	8.850	6.750	104.821	103.012	80.729	54.379	46.585	58.065	650.018
Gianelli Pumping-Generating Plant (SWP share)	19.401	21.137	12.943	7.369	(0.900)	0.043	15.257	15.509	16.089	11.379	28.609	36.752	183.589
Dos Amigos Pumping Plant (SWP share)	37.972	21.328	39.200	35.448	40.547	36.783	47.055	38.108	26.875	17.943	8.243	9.668	359.171
Buena Vista Pumping Plant	37.742	38.435	55.781	56.087	54.694	43.648	59.308	56.725	45.597	31.891	23.184	22.974	526.067
Teerink Pumping Plant	41.165	42.149	62.048	61.379	57.760	44.153	62.367	60.265	49.517	35.951	26.932	26.326	570.011
Chrisman Pumping Plant	91.511	92.906	136.198	133.557	123.613	94.215	134.756	131.168	109.300	78.911	59.362	57.285	1,242.781
Edmonston Pumping Plant	340.582	345.909	505.413	496.345	454.970	339.852	493.218	480.418	399.236	287.508	217.717	209.843	4,571.011
Alamo Powerplant (station service)	0.099	0.073	0.068	0.063	0.048	0.002	0.000	0.009	0.010	0.003	0.002	0.019	0.395
Pearlblossom Pumping Plant	63.923	29.333	60.019	59.372	63.657	61.572	74.323	63.494	54.397	46.553	44.289	26.701	647.634
Pine Flat Powerplant (station service)	0.092	0.122	0.000	0.038	0.000	0.000	0.000	0.024	0.205	0.278	0.293	0.289	1.340
Mojave Siphon Powerplant (station service)	0.007	0.046	0.001	0.000	0.002	0.001	0.000	0.000	0.014	0.001	0.000	0.012	0.085
Devil Canyon Powerplant (station service)	0.000	0.000	0.000	0.000	0.001	0.001	0.000	0.002	0.000	0.002	0.000	0.002	0.008
Oso Pumping Plant	12.947	27.448	33.041	31.744	24.890	11.699	24.049	27.041	22.290	13.382	6.858	13.656	249.043
Warne Powerplant (station service)	0.134	0.000	0.000	0.006	0.014	0.230	0.009	0.000	0.000	0.002	0.135	0.241	0.770
Las Perillas Pumping Plant	0.367	0.306	0.620	1.020	1.435	1.726	1.842	1.527	0.910	0.500	0.155	0.177	10.585
Badger Hill Pumping Plant	0.941	0.778	1.623	2.666	3.698	4.343	4.617	3.773	2.318	1.303	0.381	0.437	26.878
Devil's Den Pumping Plant	1.174	1.038	1.761	1.857	2.619	2.634	2.544	2.327	2.242	1.739	0.700	1.280	21.915
Bluestone Pumping Plant	1.105	0.982	1.672	1.761	2.499	2.509	2.410	2.195	2.102	1.637	0.659	1.205	20.735
Polonio Pass Pumping Plant	1.205	1.065	1.780	1.861	2.629	2.656	2.565	2.352	2.249	1.741	0.702	1.290	22.094
Greenspot Pumping Plant	0.813	0.645	0.639	0.489	1.068	0.611	0.597	0.627	0.826	0.706	1.020	0.881	8.923
Crafton Hills Pumping Plant	0.995	0.790	0.772	0.529	0.833	0.534	0.602	0.587	0.484	0.591	1.001	1.060	8.778
Cherry Valley Pumping Plant	0.160	0.125	0.028	0.019	0.026	0.016	0.019	0.020	0.016	0.013	0.025	0.016	0.482
<i>Subtotal</i>	723.183	668.472	989.647	941.945	860.248	663.383	1,049.656	1,008.205	830.167	597.874	480.100	478.493	9,291.374
High Voltage Transmission Line Losses and Deviation	58.389	55.351	43.853	21.112	(8.774)	34.663	47.061	3.587	26.214	64.354	48.795	87.335	481.940
<b>Total Energy Required for SWP</b>	<b>781.572</b>	<b>723.823</b>	<b>1,033.500</b>	<b>963.057</b>	<b>851.474</b>	<b>698.047</b>	<b>1,096.716</b>	<b>1,011.792</b>	<b>856.381</b>	<b>662.227</b>	<b>528.895</b>	<b>565.828</b>	<b>9,773.314</b>

**Table 10-2 Energy Generated and Purchased in 2007, by Month (Millions of Kilowatt-Hours)**

Sources of Energy	Jan	Feb	Mar	Apr	May	Jun	Jul	Aug	Sept	Oct	Nov	Dec	Total
<b>SWP Energy Sources</b>													
Hyatt-Thermalito Powerplant	111,781	102,259	139,294	162,555	172,931	253,083	336,030	270,962	176,156	122,616	144,290	84,887	2,076,844
Gianelli Pumping-Generating Plant (SWP share)	18,569	17,424	40,947	44,526	62,426	46,814	11,314	2,662	0.000	0.000	0.000	0.995	245,677
Alamo Powerplant	0.000	0.000	0.185	0.200	2,717	9,371	10,114	8,036	7,624	7,050	7,213	4,813	57,323
Mojave Siphon Powerplant	7,210	3,842	6,422	6,462	6,921	7,067	8,503	6,929	5,972	5,044	4,882	2,650	71,904
Devil Canyon Powerplant	117,755	60,100	102,426	103,000	113,184	117,293	125,639	114,673	91,800	83,671	78,614	44,427	1,152,582
Reid Gardner Unit 4	147,722	147,548	154,575	1,748	115,573	125,890	118,151	160,207	141,025	120,730	128,760	153,319	1,515,248
Warne Powerplant	26,753	50,691	56,100	53,393	50,504	24,925	45,971	47,294	46,410	29,127	0.209	26,405	457,782
<i>Subtotal</i>	<i>429,790</i>	<i>381,864</i>	<i>499,949</i>	<i>371,884</i>	<i>524,256</i>	<i>584,443</i>	<i>655,722</i>	<i>610,763</i>	<i>468,987</i>	<i>368,238</i>	<i>363,968</i>	<i>317,496</i>	<i>5,577,360</i>
<b>Energy Sources from Long-Term Agreements</b>													
Castaic Powerplant	34,989	97,978	120,091	91,323	86,474	43,261	87,496	94,199	75,968	46,683	25,914	46,137	850,513
Metropolitan Small Hydro Generation	10,379	5,613	10,138	11,761	13,663	14,433	11,800	14,453	15,826	15,339	13,587	8,150	145,142
Pine Flat Powerplant (Kings River Conservation Dist.)	0.079	2,648	6,020	5,746	34,554	72,079	62,070	11,614	0.000	0.000	0.000	0.000	194,810
Power Exchange Delivered to Other Entities	0.000	0.000	0.000	0.000	(31,000)	(30,000)	(31,000)	(31,000)	(30,000)	0.000	0.000	0.000	(153,000)
Power Exchange Received from Other Entities	43,400	39,200	43,225	0.000	0.000	0.000	0.000	0.000	24,000	43,400	42,175	43,400	278,800
Power Exchange Delivered to SCE	0.000	0.000	0.000	0.000	0.000	0.000	0.000	0.000	0.000	0.000	0.000	0.000	0.000
Power Exchange Received from SCE	0.000	0.000	0.000	0.000	0.000	0.000	0.000	0.000	0.000	0.000	0.000	0.000	0.000
Energy to Metropolitan for CRA <sup>a</sup> Pumping	0.000	0.000	0.000	0.000	0.000	0.000	0.000	0.000	0.000	0.000	0.000	0.000	0.000
Energy from Metropolitan for CRA <sup>a</sup>	0.000	0.000	0.000	0.000	0.000	0.000	0.000	0.000	0.000	0.000	0.000	0.000	0.000
Power System Imbalances	0.000	0.000	0.000	0.000	0.000	0.000	0.000	0.000	0.000	0.000	0.000	0.000	0.000
<b>Purchases</b>													
Purchases (Firm and Power Contractors)	464,689	435,010	470,096	551,960	410,169	339,012	513,965	490,207	483,033	394,751	370,176	402,817	5,325,887
<i>Subtotal</i>	<i>553,536</i>	<i>580,449</i>	<i>649,570</i>	<i>660,790</i>	<i>513,860</i>	<i>438,785</i>	<i>644,331</i>	<i>579,473</i>	<i>568,827</i>	<i>500,173</i>	<i>451,852</i>	<i>500,504</i>	<i>6,642,152</i>
Total Resources	983,326	962,313	1,149,519	1,032,674	1,038,116	1,023,228	1,300,053	1,190,236	1,037,814	868,411	815,820	818,000	12,219,512
Less Energy Sales	(201,754)	(238,490)	(116,019)	(69,617)	(186,642)	(325,181)	(203,337)	(178,444)	(181,433)	(206,184)	(286,925)	(252,172)	(2,446,198)
<b>Total Energy Provided to the SWP</b>	<b>781,572</b>	<b>723,823</b>	<b>1,033,500</b>	<b>963,057</b>	<b>851,474</b>	<b>698,047</b>	<b>1,096,716</b>	<b>1,011,792</b>	<b>856,381</b>	<b>662,227</b>	<b>528,895</b>	<b>565,828</b>	<b>9,773,314</b>

<sup>a</sup> Contractual Resource Arrangement.

**Table 10-3 Power, Transmission, and Related Purchases in 2007, by Service Area**

Purchase Category	Power (MWh)	Power Cost (Dollars)	Total Cost (Dollars)
<b>Power Purchases</b>			
Northern California Area	206,691	2,214,420.79	2,214,420.79
Southern California Area	896,745	48,101,944.83	48,101,944.83
Energy Marketers	3,866,052	213,351,277.91	213,351,277.91
<i>Subtotal</i>	<i>4,969,488</i>	<i>263,667,643.53</i>	<i>263,667,643.53</i>
<b>Transmission and Other Purchases</b>			135,727,354.22
<b>Miscellaneous Fees</b>			919.60
<i>Subtotal</i>			<i>135,728,273.82</i>
<b>Total</b>	<b>4,969,488</b>	<b>263,667,643.53</b>	<b>399,395,917.35</b>

**Table 10-4 Energy Sold in 2007 and Revenue from Sales, by Service Area**

Region	Energy Sold (MWh)	Revenue from Energy Sales (Dollars)	Revenue from Exchanges, Capacity, and Other Energy-Related Services (Dollars)	Total Power Sales (Dollars)
Pacific Northwest Area	190	12,912.00		12,912.00
Northern California Area	82,301	5,486,416.00	36,225,490.00	41,711,906.00
Southern California Area	595,306	36,614,485.00	2,617,450.00	39,231,935.00
Southeast Area	198,452	15,588,655.00	1,582,069.00	17,170,724.00
Energy Marketers	1,388,053	81,187,700.00		81,187,700.00
<b>Total</b>	<b>2,264,302</b>	<b>138,890,168.00</b>	<b>40,425,009.00</b>	<b>179,315,177.00</b>



## **Chapter 11**

# **Facilities Maintenance**

*Thermalito Afterbay Outlet on the Feather River.*



## Significant Events in 2007

**F**lowing water in the Gorman Creek Improvement Channel broke out pieces of the concrete channel lining, exposing and scouring the soil behind the lining upstream of the inlet to Gorman Creek Siphon. Approximately 1,000 feet was repaired from Station 115+75 to the Gorman Creek Siphon due to the initial break.

Three 20-foot sections of the Peace Valley Pipeline were completely encased in reinforced concrete to strengthen the pipeline's structural integrity. The resulting cross section of the work is the 144-inch diameter pipe encased in a 17' x 17' block of concrete.

A Director's Safety Review Board was convened in January 2007 for the dams in the Delta Field Division, and a Director's Safety Review Board for Upper Feather River Dams was held in November 2007. The Safety Review Board found all facilities safe for continued operation.

A construction application for enlargement of Patterson Dam's Reservoir was filed with Division of Safety of Dams in May 2007.

*Information for this chapter was provided by the Division of Operations and Maintenance, the Division of Safety of Dams, and the State Water Project Analysis Office.*

The Department of Water Resources (DWR), through the Division of Operations and Maintenance (O&M), monitors all State Water Project (SWP) facilities to ensure safety and reliability. DWR is required, by federal and State law, to contract periodically with independent consultants to review the safety of SWP dams and power facilities.

## Inspecting and Maintaining Project Dams

DWR conducts several types of inspections of SWP facilities to ensure that each dam is safe for continued operation. O&M staff collect and evaluate data about the performance of each facility. Engineers from the Division of Safety of Dams (DSOD) review instrumentation data and inspect jurisdictional SWP dams, either semi-annually or annually. They evaluate proposed modifications to existing dams, as well as the design and construction of new jurisdictional dams. The Federal Energy Regulatory Commission (FERC) inspects all licensed SWP facilities annually. These inspections include a review of significant events, instrumentation data, and the visual appearance of each dam, penstock, or power plant. In addition, under FERC and California Water Code (CWC) requirements, consulting engineers and geologists are retained to evaluate SWP dam facilities every 5 years.

DWR contracts periodically with independent consultants to review the safety of SWP dams and power facilities, except Pearblossom Spill Basin. The four dams in the San Luis Field Division (Sisk, O'Neill, Los Banos Detention, and Little Panoche Detention) are used jointly with the Bureau of Reclamation (Reclamation), and are not under DSOD jurisdiction. Pearblossom Spill Basin Dam was originally designed to be used during misoperation at the Pearblossom Pumping Plant; the spill basin was never fully completed and has never been used.

## Routine Inspections

During 2007, DSOD, along with O&M staff, inspected Frenchman, Antelope, and Grizzly Valley dams in the Upper Feather River area; Oroville, Bidwell Bar, Parish Camp Saddle Dam, and Thermalito Afterbay dams in the Oroville Field Division; Clifton Court Forebay, Bethany, Patterson, and Del Valle dams in the Delta Field Division; and Pyramid, Castaic, Cedar Springs, Devil Canyon Powerplant Second Afterbay, Perris, and Crafton Hills dams in the Southern Field Division.

## Joint-Use Facility Inspection

Every 6 years, Reclamation conducts a Comprehensive Facility Review (CFR) of the four joint-use facility dams in the San Luis Field Division. The next CFR is scheduled to be conducted from February to March of 2009. Periodic Facility Reviews (PFRs) are also conducted by Reclamation every 6 years using an alternate schedule spaced in between the CFR schedule. PFRs were conducted for the joint-use facilities in May and June of 2006. No PFRs were conducted in 2007.

## Independent Reviews

### California Water Code Reviews

To comply with the CWC and the California Code of Regulations, DWR is required to retain a consulting board to review: (1) the adequacy of the design of any dam or reservoir DWR proposes to construct and (2) the safety of the completed construction, including the terms and conditions for the Certificate of Approval.

These provisions require DWR to retain a board of three consultants to meet at least once every 5 years to review the operational performance of DWR-owned dams and more frequently when consulting on new dams. The board of consultants independently reviews and assesses safety conditions of SWP dams.

Consultants are selected based on their knowledge of geotechnical, structural, and civil engineering, including their experience in evaluating dam performance. Their independent assessments include the review of dam performance during earthquakes, evaluation of instrumentation data, inspection of each dam, and evaluation of studies performed by DWR. The consultants then prepare reports on each dam, approving dams as safe for continued operation and making recommendations. Based on these recommendations, DWR prepares action plans.

A Director's Safety Review Board was convened in January 2007 for the dams in the Delta Field Division, and a Director's Safety Review Board for Upper Feather River Dams was held in November 2007. The Safety Review Board found all facilities safe for continued operation.

Review boards for Crafton Hills Dam and Castaic Dam will be held in early 2008.

### **FERC Reviews**

These reviews and the FERC Part 12D safety inspections, which may be conducted by one or more consultants, are scheduled every 5 years. As a supplement to the FERC Part 12D safety inspection, FERC's Dam Safety Performance Monitoring Program requires that a Potential Failure Mode Analysis (PFMA) be performed for FERC-licensed dams. The PFMA involves document review and site visits to develop a comprehensive list of potential failure modes at each dam. From this review process, three

documents are generated: the FERC Part 12D safety inspection report; PFMA report; and Supporting Technical Information Document (STID), which summarizes the project elements and details that do not change significantly over time.

## **Arroyo Pasajero Program**

The Arroyo Pasajero and its tributaries drain approximately 530 square miles of the Diablo Range of the coastal mountains west of the California Aqueduct in Fresno County. Its downstream juncture with the San Luis Canal segment of the California Aqueduct, between Highway 198 and Avenal Cutoff Road, poses a particularly difficult operational and maintenance problem for the SWP. Reclamation designed and constructed the San Luis Canal segment of the California Aqueduct, while DWR operates and maintains it, with all costs shared 45 percent and 55 percent, respectively.

During periods of heavy rainfall, high flows in the Arroyo Pasajero and its tributaries transport heavy sediment loads eroded from the Arroyo Pasajero watershed. Over a vast amount of time, sediment transported by arroyo floods formed a 450-square-mile alluvial fan extending from its apex at the eastern margin of Pleasant Valley (Anticline Ridge) to the San Joaquin Valley trough. The California Aqueduct traverses the arroyo's alluvial fan and forms a barrier to arroyo flood flows. Flood control facilities, designed to accommodate Arroyo Pasajero floodwater, include the West Side Detention Basin (designed to store floodwater and sediment west of the California Aqueduct), an evacuation culvert to release floodwater east of the California Aqueduct, and drain inlets to release floodwater into the California Aqueduct.

Since the floods of 1969, when nearly all of the detention basin's planned 50-year sediment storage capacity was filled by deposition, DWR and Reclamation have

worked to mitigate the effects of heavy flooding and the diminished storage capacity of the detention basin. In 1980, asbestos was discovered in the Metropolitan Water District of Southern California's water supply and traced to runoff from the Arroyo Pasajero and other Diablo Range streams. This discovery, in conjunction with the high cost of removing sediment from the California Aqueduct, led DWR to adjust operating procedures to minimize runoff entering the California Aqueduct. The volume of runoff and sediment transported by the Arroyo Pasajero is roughly 400 percent greater than was originally estimated during the detention basin design in the mid-1960s.

### **DWR and DWR/Reclamation Alternative Long-term Solution**

Construction to restore the storage capacity of the West Side Detention Basin started in August 2004, and many of the improvements were completed by the summer of 2005. These improvements restored the storage capacity to the detention basin and added control over releases of floodwater into the California Aqueduct and onto private farmland. The intended 50-year level of protection is achieved by raising levees, adding a control structure equipped with a rubber dam, installing flood gates, and acquiring flood easements.

One project component yet to be implemented, is to armor the railroad embankment to reduce damages when it is overtopped by floodwater. This component has not been implemented due to difficulties in negotiating the improvements with the owners of the railroad. As of 2007, this was still an ongoing issue. In 2007, DWR continued to work with local landowners and the courts on efforts to settle litigation that involved the acquisition of necessary easements and fee property interest for the project.

### **Related Activities**

DWR, with the support of the State Water Contractors, continued during 2006 to provide funds and staff support to a Coordinated Resource Management Plan group, called the Stewards of the Arroyo Pasajero Watershed. This group was not active in 2007 and therefore, DWR's participation came to an end.

Planning for a restoration project similar to the West Side Detention Basin restoration project began in 2006 for the Cantua Creek Stream Group detention basins and continued in 2007. The project goal is to improve aqueduct flood protection and water quality.

A draft reconnaissance study for the Cantua Creek Stream Group Improvement Project identified actions such as raising embankments, making modifications to structures, and acquiring flood easements to provide a 50-year level of protection for the California Aqueduct at the Cantua Creek Stream Group. Improving water quality in the aqueduct was a significant goal of the study, since currently, several of the existing drain inlets are not gated and sediment-laden floodwater flows directly into the aqueduct with little detention. It has been widely understood that increasing flood storage and detention of this floodwater prior to releasing it into the aqueduct would provide a significant benefit to water quality in the aqueduct. As of 2007, DWR plans to continue work on the study to prepare feasibility-level designs and estimate costs.

During 2007, DWR initiated efforts to obtain alternative funding sources for projects associated with the Arroyo Pasajero Program. Inquiries were made to FloodSAFE about potentially using Proposition 84 and 1E funds on the Reclamation/DWR joint-use facilities. In addition, an effort was made to obtain funding via Assembly Bill 669 for construction of a bridge at State Highway Route 269 and the Arroyo Pasajero crossing.

## Repairs and Modifications

DWR continually monitors all SWP facilities and performs repairs and modifications as necessary to ensure safe, reliable water delivery.

Table 11-1 presents information, arranged chronologically, about significant scheduled and unscheduled outages at SWP pumping and power plants in 2007. The table includes information about incidents resulting in outages exceeding 14 days.

**Table 11-1 Outages for Maintenance and Repair of Facilities in 2007, by Month**

Month	Facility	Units Taken Out of Service
January	Banks Pumping Plant	Unit 6 from January 29 to April 9 for annual maintenance
	Banks Pumping Plant	Unit 7 from January 8 to February 5 for annual maintenance
	South Bay Pumping Plant	Unit 6 from January 8 to March 23 to inspect bearings and impeller, realign pump, and repair cooling water line
	Dos Amigos Pumping Plant	Unit 1 from January 8 to February 20 for biennial maintenance
	Las Perillas Pumping Plant	Unit 2 from January 31 to April 4 to refurbish motor
	Badger Hill Pumping Plant	Unit 2 from January 31 to April 12 to refurbish motor
	Pearblossom Pumping Plant	Unit 3 from January 6 to September 25 to replace failed rotor windings and rebuild pump
February	Gianelli Pumping-Generating Plant	Units 7 and 8 from February 26 to June 6 for biennial maintenance, to perform weld repair on scroll case and draft tube, and work on headgate
	Devil's Den Pumping Plant	Unit 1 from February 10 to March 2 to investigate phase current imbalance
	Teerink Pumping Plant	Unit 5 from February 26 to May 23 to rewind motor and recoat discharge line
March	Pearblossom Pumping Plant	Unit 8 from March 26 to October 22 to repair shaft and replace pump seal
	Reid Gardner Powerplant	Unit 4 from March 30 to April 29 for annual maintenance and to upgrade boiler
April	Banks Pumping Plant	Unit 4 from April 2 to April 18 for annual maintenance
	Banks Pumping Plant	Unit 5 from April 23 to June 15 for annual maintenance
	Dos Amigos Pumping Plant	Unit 3 from April 16 to May 22 for biennial maintenance
	Teerink Pumping Plant	Unit 9 from April 23 to August 9 to rewind motor and recoat discharge line
May	Thermalito Diversion Dam Powerplant	Unit 1 from May 9 to May 29 to investigate governor problems
	Thermalito Diversion Dam Powerplant	Unit 1 from May 31 to July 26 to replace governor power supply and make other governor repairs
June	Chrisman Pumping Plant	Units 1 through 3 from May 7 to May 21 to modify transformer KYA relays
	Banks Pumping Plant	Unit 8 from June 3 to July 12 to replace upstream o-ring seal
	South Bay Pumping Plant	Unit 1 from June 26 to July 11 to adjust automatic voltage regulator and motor synchronization timer
	Dos Amigos Pumping Plant	Unit 4 from June 4 to June 26 to repack discharge line coupling and recoat stay vanes
July	Banks Pumping Plant	Unit 11 from July 16 to September 10 for annual maintenance and to repair discharge valve upstream seat
	Polonio Pass Pumping Plant	Unit 3 from July 16 to September 13 replace motor bearings
	Edmonston Pumping Plant	Unit 7 from July 9 to expected completion date in 2008 to refurbish motor and pump
August	Teerink Pumping Plant	Unit 1 from August 20 to December 20 to rewind motor, replace 13.8 kV bus, and work on transformer KYA
	Teerink Pumping Plant	Unit 7 from August 13 to September 25 to recoat discharge line
	Mojave Siphon Powerplant	Unit 2 from August 6 to August 30 for annual maintenance
September	Banks Pumping Plant	Unit 3 from September 10 to September 28 to repair motor
	Banks Pumping Plant	Unit 6 from September 27 to October 26 to replace failed o-ring
	Banks Pumping Plant	Unit 10 from September 24 to October 26 for annual maintenance
	South Bay Pumping Plant	Units 1 through 4 from September 30 to October 15 for pipeline encasement
	Gianelli Pumping-Generating Plant	Units 5 and 6 from September 19 to expected completion date in 2008 for annual maintenance, to weld repair scroll case and draft tube, repair AVR, and work in switchyard
	Dos Amigos Pumping Plant	Unit 2 from September 10 to November 20 for biennial maintenance

**Table 11-1 Outages for Maintenance and Repair of Facilities in 2007, by Month** *(continued)*

Month	Facility	Units Taken Out of Service
	Polonio Pass Pumping Plant	Unit 1 from September 16 to expected completion date in 2008 to send motor to vendor for testing and to rebuild discharge valve
	Buena Vista Pumping Plant	Unit 6 from September 4 to November 1 to overhaul and realign motor and pump
	Mojave Siphon Powerplant	Unit 3 from September 10 to September 27 for annual maintenance
	Oso Pumping Plant	Unit 5 from September 13 to expected completion date in 2008 to repair broken amortisseur bar
	Pine Flat Powerplant	Unit 2 from September 17 to expected completion date in 2008 for annual maintenance and to recoat penstock
October	Banks Pumping Plant	Unit 9 from October 24 to November 29 for annual maintenance
	Barker Slough Pumping Plant	Unit 4 from October 7 to October 24 to repair unit breaker
	Gianelli Pumping-Generating Plant	Unit 4 from October 15 to November 17 to repair leaks in oil-cooling coils for lower motor guide bearing
	Devil Canyon Powerplant	Unit 4 from October 15 to November 8 for annual maintenance
	Oso Pumping Plant	Unit 3 from October 25 to November 30 to replace raw water header piping
	William Warne Powerplant	Unit 2 from October 1 to November 30 for annual maintenance, to clean cooling water sump, and to work on Peace Valley Pipeline encasement
November	Hyatt Powerplant	Unit 4 from November 25 to expected completion date in 2008 to adjust wicket gates, work on governor, and repair coating
	Banks Pumping Plant	Unit 1 from November 14 to December 17 to repair discharge valve
	Buena Vista Pumping Plant	Units 1 through 6 from November 5 to November 30 to replace 13.2kV bus and work on transformer KYA
	Teerink Pumping Plant	Units 2 through 5 from November 5 to December 2 to replace 13.8kV bus and work on transformer KYA
	Edmonston Pumping Plant	Unit 3 from November 5 to December 28 to rewedge stator and inspect rotor
	Edmonston Pumping Plant	Unit 6 from November 25 to December 17 to modify lower pump oil tub
	Oso Pumping Plant	Units 1 and 2 from November 5 to November 30 to replace raw water header piping
	William Warne Powerplant	Unit 1 from November 1 to November 30 to work on Peace Valley Pipeline encasement
December	Gianelli Pumping-Generating Plant	Unit 2 from December 12 to December 28 to install larger sump pumps and drain flooded turbine pit
	Badger Hill Pumping Plant	Unit 5 from December 4 to expected completion date in 2008 to refurbish motor
	Buena Vista Pumping Plant	Units 7 through 10 from December 4 through December 21 to replace 13.2kV bus
	Teerink Pumping Plant	Unit 7 from December 3 to December 24 to replace 13.8kV bus
	Teerink Pumping Plant	Units 6, 8 and 9 from December 3 to December 21 to replace 13.8kV bus
	Mojave Siphon Powerplant	Unit 1 from December 3 to December 19 for annual maintenance



## **Chapter 12 Engineering, Construction, and Real Estate**

*Levee project on the San Joaquin River near Lathrop.*



## Significant Events in 2007

The Department of Water Resources (DWR) prepared conceptual-level cost estimates for isolated conveyance options and existing Delta channel improvements. DWR used a 15,000 cubic feet per second diversion from the Sacramento River near Hood to the State and federal export locations at Clifton Court Forebay. The options were primarily based on the concepts outlined in *Descriptions of Potential Bay Delta Conservation Plan Conservation Strategy Options*, May 2007.

Engineering, construction and real estate work to enhance, expand, repair, and protect the State Water Project and other facilities within the State continued. Other significant projects included South Bay Aqueduct Enlargement, expansion of South Bay Pumping Plant, Tehachapi East Afterbay construction, East Branch Enlargement, Edmonston Pumping Plant refurbishment, Hyatt Powerplant Pump-Turbine refurbishment, and the East Branch Extension Phase I Improvements and Phase II projects.

Construction was completed in December 2007 on a fish containment system at the outlet structure of Grizzly Valley Dam (Lake Davis) to prevent all life stages of northern pike from escaping from Lake Davis.

*Information for this chapter was provided by the Division of Engineering.*

Initial construction of the State Water Project (SWP) facilities began in 1957 with the relocation of the Western Pacific Railroad facilities and Highway 70 near the City of Oroville to accommodate the SWP Oroville Facilities. Oroville Dam was constructed between 1961 and 1967. Construction of the South Bay Aqueduct (SBA) facilities was started in 1960, and the first SWP water was delivered through the SBA in 1965 to serve Alameda and Santa Clara counties.

In 1963, work began on the California Aqueduct, and by 1968, the State Water Project (SWP) was delivering water to long-term contractors in the San Joaquin Valley to the foot of the Tehachapi Mountains. By 1973, with the completion of Edmonston Pumping Plant at the foot of the Tehachapi Mountains and other East Branch conveyance facilities, the SWP was delivering water to Lake Perris at the southernmost point in Los Angeles County.

In 1974, SWP water was delivered to Los Angeles County through the West Branch Facilities. SWP water was delivered to Napa County in 1968, through the first phase facilities of the North Bay Aqueduct, and to Solano County in 1988 by the second phase facilities. The first SWP water delivery through the Coastal Branch (Phase I) was made in 1968 to Kings and Kern counties.

Prior to the completion of the initial facilities in 1973, work began on the Upper Feather River facilities to supply local water, recreation, and fish enhancement. Power plants, additional pumping units, and turbine-generators that had been deferred from the initial construction of the SWP were built to ensure water quality and fish enhancement in the Delta.

From the 1980s through 2005, design and construction activities shifted to repairing concrete lining failures or potential failures of the canal system and concrete pipeline sections; replacing equipment components of existing facilities; enlarging or extending aqueduct reaches; adding pumps and motors

to existing facilities; constructing the Devil Canyon Second Afterbay; constructing Phase II of the Coastal Branch to deliver water to San Luis Obispo and Santa Barbara counties in August 1997; and extending the SWP through the East Branch Extension to the San Geronio Pass service area in San Bernardino and Riverside counties. The East Branch Extension Phase I became operational in 2003.

## Design Activities

In 2007, work to enhance, expand, repair, and protect water delivery in the SWP continued. Engineering activities supported more efficient water deliveries within the confines of legal constraints, environmental restraints, and power availability. Significant projects included South Bay Aqueduct Enlargement, South Bay Pumping Plant expansion, Tehachapi East Afterbay construction, East Branch enlargement, and feasibility studies for the East Branch Extension Phase I Improvements and Phase II projects. In addition, public scoping meetings were held for the East Branch Extension Phase II project in April 2007 and the Phase I Improvements project in December 2007. Table 12-1 (at the end of the chapter) provides a list of completed and ongoing design work that was undertaken in 2007.

The Department of Water Resources (DWR) designed projects for development into construction contracts. Division of Engineering (DOE) staff worked with the Division of Operations and Maintenance,

Bay-Delta Office, Division of Flood Management, Division of Environmental Services, Office of the Chief Counsel, Department of Fish and Game, Department of Boating and Waterways, California Department of Transportation, SWP water contractors, California water districts, Sacramento River, San Joaquin River, and Delta levee maintenance districts, CALFED, U.S. Army Corps of Engineers, Bureau of Reclamation, Federal Energy Regulatory Commission, U.S. Environmental Protection Agency, U.S. Fish and Wildlife Service, National Marine Fisheries Service, and other entities concerned with water resources activities. DOE staff prepared preliminary designs and estimates, and conducted special studies of dams, canal embankments, and other SWP facilities.

In 2007, DWR prepared conceptual-level cost estimates for isolated conveyance options and existing Delta channel improvements. DWR used a 15,000 cubic feet per second (cfs) diversion from the Sacramento River near Hood to the State and federal export locations at Clifton Court Forebay. The options were primarily based on the concepts outlined in *Descriptions of Potential Bay Delta Conservation Plan Conservation Strategy Options*, May 2007.

The basis of each option (alignment and location of the intake and outlet) was derived from the Bay Delta Conservation Plan with some deviation of alignment depending on the local geological and foundation conditions for the construction of the canal embankment and relocation of existing facilities such as roads. Conveyance components included intake facilities (e.g., trashracks, flood control gates, fish screens, etc.), canals, siphons, culverts, bridges, and forebays. Delta channel improvements included intake facilities, canals, pumping plants, channel dredging, setback levees, and river barriers.

The cost estimates were conceptual and did not include environmental analysis or mitigation.

Other studies, reports, and activities continued from previous reporting periods, or initiated in 2007, include the following:

- stability analysis for Oroville, Parish Camp Saddle, Bidwell Canyon Saddle, and Thermalito dams;
- geologic faulting and seismicity studies of SWP and flood control facilities;
- Banks Pumping Plant cut slope evaluation;
- Dos Amigos Pumping Plant trash rake system replacement;
- Frank's Tract Pilot Project—conceptual design;
- South Delta Improvement Project, permanent operable barriers—final design;
- fish screens at Sherman and Twitchell islands—preliminary design;
- Delta smelt refugium at Skinner Fish Facility—final design;
- South Bay Aqueduct reliability study;
- South Bay Aqueduct enlargement and improvement activities;
- Gianelli Pumping-Generating Plant power transformer second containment basin;
- Gianelli Pumping-Generating Plant replacement of eight 156-inch butterfly valves;
- canal lining repair, Milepost 56.4 to 164.9;
- flood control improvements, Weir No. 2 Rehabilitation, Lower Butte Creek, Sutter Bypass;
- concrete encasement of Coastal Aqueduct pipeline for Highway 46 widening;
- Devil's Den Pumping Plant trashrack/traveling screen modification;
- evaluation of the hydrology and capacity of the cross-drainage facilities, Buena Vista and Teerink pumping plants;

- Warne Powerplant penstock cooling water transient study;
- Castaic, Pyramid, and Perris dams—emergency release facilities;
- Castaic Dam and Perris Dam breach inundation study;
- Pearblossom Disposal Area assessment study, Phase II;
- Hesperia Master Drainage Plan for Antelope Wash and adjacent area;
- East Branch Enlargement, Phase II preliminary design and environmental impact reports;
- East Branch Extension, Phase I Improvements and Phase II prefeasibility studies;
- Santa Ana Pipeline repair;
- Peace Valley Pipeline repair;
- North Bay Aqueduct alternate intake study; and
- Perris outlet tower study.

In 2007, DOE staff completed the following studies and activities:

- Byron Road Bridge deck deterioration study and analysis;
- Sites Reservoir inundation study;
- Castaic Dam high intake tower and access bridge analysis;
- Thermalito Forebay Dam, piezometer P 66 artesian pressure study;
- South Feather Water and Power Agency's Miners Ranch Canal—erosion sites repair study;
- Miner's Ranch erosion repair study;
- San Joaquin River Restoration Program—appraisal level design;
- feasibility of using low-pressure carbon dioxide (CO<sub>2</sub>) system at Chrisman Pumping Plant;
- feasibility study for furnishing spare parts for the Baldwin-Lima-Hamilton pumps at Edmonston Pumping Plant;
- feasibility study for replacing the east/west elevators at Edmonston Pumping Plant;

- feasibility study to replace the heating ventilation and air conditioning system at Gianelli Pumping-Generating Plant;
- feasibility study to replace the fire alarm system at San Luis and Coalinga Operations and Maintenance Centers; and
- Vista del Lago Visitors Center—erosion repair.

## Construction Activities

DOE worked on 71 construction contracts in 2007. Projects included turbine and pump replacement, pipeline repair, trashrack upgrade at fish hatcheries, and recreational and maintenance facilities improvements at dam and reservoir sites. Table 12-2 (at the end of the chapter) shows contract title, specification number, date the contractor received the Notice to Begin Work, the expected or actual acceptance date (physical completion date is discussed in narratives below), and the actual or estimated contract cost (including change orders for added work). Resolution of contract claims may extend the actual contract closeout beyond the completion or acceptance date.

### Upper Feather River Division

#### *Grizzly Valley Dam*

A fish containment system at the Grizzly Valley Dam outlet structure was constructed to prevent northern pike from exiting Lake Davis and entering Big Grizzly Creek (Specification No. 06-11). Construction began in June 2006 and was completed in November 2007. Contract administrative items are expected to continue throughout 2008.

### Oroville Division

#### *Hyatt Powerplant*

Refurbishment of turbine Units 1, 3, and 5 began in February 1999 (Specification No. 98-22) and ended in 2006. The contractor continued working on its final

contract submittals, including operations and maintenance manuals, throughout 2007.

Refurbishment of pump-turbine Units 2, 4, and 6, started in November 2001 (Specification No. 01-11), continued throughout 2007. Completion is expected in 2008.

## Delta Facilities

### *Middle River, Old River, and Grant Line Canal*

Work on a multiyear (2004 through 2006) contract (Specification No. 03-07) to install and remove seasonal temporary rock barriers in designated South Delta waterways (Middle River, Old River, and Grant Line Canal) was completed in December 2006 and accepted in June 2007.

The temporary barriers were installed to enhance water levels and circulation in the South Delta for local agricultural diversion, to assist fish migration, and to gather hydraulic data for the design of future permanent barriers. Changed or added work per contract change order included:

- emergency relocation of flood supplies;
- urgent repairs to a divider wall at the Skinner Fish Facility;
- temporary agricultural pumping;
- removal and replacement of the Roaring River Slough flapgate and flashboard riser;
- removal and replacement of flashboards at Montezuma Slough;
- repairs to Sherman Island fish screens;
- construction of the Vernalis water quality station;
- pumps and equipment for the Travis Surge Tank sediment removal;
- pumps at C-Line Ditch;
- testing of air pockets, nozzles, and valves at Brushy Creek;
- geologic trenching at Patterson;

- pondweed abatement at Clifton Court Forebay;
- vegetation removal at California Aqueduct Milepost 10.75;
- piles for the South Delta (Franks Tract, Delta-Mendota Canal, Grantline Canal);
- hyacinth removal in Tom Paine Slough;
- dredging of Bethany Reservoir and Middle River;
- demolition of a building and a cap well at Grizzly Slough;
- new pumps at Skinner Fish Facility;
- an environmental impact report and an action plan for the South Delta Improvements Program;
- removal of frames at Morrow Island and Horseshoe Bend;
- high density, electrical resistivity survey;
- aquatic herbicide application at Clifton Court Forebay;
- trashrake gripper for Skinner Fish Facility; and
- barge crane for Montezuma Slough.

On January 30, 2007, DWR issued the Notice to Begin Work for the new temporary barriers contract (Specification No. 06-26) for work from 2007 through 2009. Contract work continued throughout the year, including the following work added by construction orders:

- weed harvesting and mapping at Clifton Court Forebay;
- removal and replacement of flashboards at Montezuma Slough; and
- Delta smelt refugium at the Skinner Fish Facility.

## Suisun March Facilities

### *Roaring River Slough*

An emergency contract (Specification No. 06-02) began in January 2006 to restore approximately 1,700 feet of levee along the north side of Roaring River Slough (Station 370+20 to 417+20) on Grizzly Island

to ensure water quality and protect Grizzly Island from future flooding. The contractor completed the work in May 2006, and DWR accepted the project in December 2007.

## **North Bay Aqueduct Napa Turnout Reservoir**

Replacement of the Napa Turnout Reservoir began in April 2007 and continued throughout the year. The contract (Specification No. 07-01) includes replacing the existing tank with two, 5-million gallon steel covered tanks and installing piping and appurtenances. Construction is expected to continue throughout 2008.

## **South Bay Aqueduct South Bay Aqueduct Enlargement and Improvement**

The South Bay Aqueduct Enlargement and Improvement projects will restore the first 16.38 miles of the South Bay Aqueduct to the 300 cfs design flow and increase the design capacity by up to 130 cfs. This work will enlarge the South Bay Pumping Plant to accommodate four additional 45 cfs units, construct a third discharge line, construct Dyer Reservoir (425 af of active storage), enlarge the canal and Patterson Reservoir, and modify associated structures.

### **Dyer Reservoir**

Contract work to construct a drainage diversion at Dyer Reservoir (Specification No. 06-24) began in September 2006 and is anticipated to be complete in October 2008. DWR extended the contract to allow a temporary bridge to remain in place due to environmental restrictions. The extension is expected to continue throughout much of 2008.

### **South Bay Pumping Plant**

A contract (Specification No. 04-05) to furnish 45 cfs pump and motor units for Units No. 10 through 13 and one spare pump

and motor for the pumping plant began in November 2004 and continued throughout 2007. Completion is expected in mid-2010.

A contract (Specification No. 04-20) to furnish valves, actuators, and hydraulic power units began in May 2005 and continued throughout the year. Repairs to the butterfly valves are expected to extend the contract into mid-2010.

A contract (Specification No. 05-10) to furnish switchyard equipment began in September 2005 and is expected to be completed in mid-2010. Added work per contract change order will furnish equipment for the Banks Switchyard expansion to accommodate the new 69 kV transmission line from Banks Pumping Plant to South Bay Pumping Plant.

A contract (Specification No. 05-05) to furnish 5-kilovolt (kV) switchgear began in October 2005. The contract submittal and measuring process continued throughout 2007. Contract completion is expected in mid-2010.

The contract (Specification No. 06-04) to construct the initial facilities for the South Bay Pumping Plant enlargement began in August 2006. Construction continued throughout 2007 and is expected to be completed in late 2008. Work to repair a leak in the South Bay Aqueduct at Milepost 32.4 was added via change order.

A contract (Specification No. 07-02) to furnish power transformers began in April 2007 and is expected to be completed in mid-2010.

The contract (Specification No. 07-18) to complete the pumping plant facilities began in December 2007. Completion is expected in mid-2010.

### ***South Bay Pumping Plant Discharge Line and Brushy Creek Pipeline No. 3***

A contract (Specification No. 06-09) to construct a South Bay Pumping Plant discharge line and the Brushy Creek Pipeline No. 3 began in December 2006. Work continued throughout the year. Completion is expected in fall 2008

### **San Luis Division**

#### ***Gianelli Pumping-Generating Plant and Dos Amigos Pumping Plant***

A contract (Specification No. 04-08) to refurbish the existing CO<sub>2</sub> fire suppression system for Motor-Generator Units No. 1 through 8 and the oil purifier room at Gianelli, and Motor Units No. 1 through 6 and the oil purifier room at Dos Amigos began in July 2004. The original work was essentially complete in November 2007, but added work via contract change order continued the rest of the year. The added work includes:

- replacing and refurbishing fire extinguishers at the San Luis Field Division;
- installing an escape platform at Dos Amigos and safety platforms at Gianelli;
- repairing the CO<sub>2</sub> systems at Edmonston, Chrisman, and Teerink pumping plants;
- replacing the fire alarm systems at San Luis Operations and Maintenance Center and at Coalinga Operations and Maintenance Center; and
- inspecting and repairing the fire sprinkler system at the San Luis Operations and Maintenance Center warehouse.

#### ***Gianelli Pumping-Generating Plant, Dos Amigos Pumping Plant, Coalinga Operations and Maintenance Subcenter, Check Sites and Flowmeter Sites***

A contract (Specification No. 06-10) to replace standby engine generators began in August 2006. Work continued throughout

2007. With the added change order work listed below (and additional change order work expected in early 2008) contract completion is expected in early 2011. The added work includes:

- furnishing and installing engine generators for the Delta Operations and Maintenance Center and for Banks Pumping Plant; and
- furnishing and installing a backup generator for University of California, Davis.

### ***San Luis Canal***

Work on a contract (Specification No. 04-03) to restore the West Side Detention Basin began in August 2004 and was completed in September 2007. Acceptance is expected in mid 2008. Restoration work included:

- earthwork;
- concrete and steel reinforcement;
- gravel road surfacing and chip sealing;
- erosion protection;
- construction of a concrete weir with inflatable rubber dam, control system, and appurtenances; and
- rehabilitation of the existing drain inlets.

Work added by change orders included:

- repairing Milepost 166R and Milepost 122R canal embankments;
- sealing and paving roads at California Aqueduct Reaches 6 and 7;
- cleaning the toe drain at O'Neill Dam;
- installing security bars at the San Luis Field Division guard building; and
- installing gates at various locations in San Joaquin Field Division.

Due to subsidence that caused buckling and cracking in the canal lining, a contract (Specification No. 07-20) to remove and replace damaged portions of the concrete lining along the California Aqueduct between

Mileposts 56.40 and 164.90 began in November 2007. Completion is expected in 2009 due to pending change order work.

## South San Joaquin Division

### *Buena Vista Pumping Plant*

A contract (Specification No. 07-05) to design, manufacture, test, and deliver spare coils (17,000 horsepower [hp] and 8,500 hp) and materials began in June 2007 and is expected to be complete in May 2009.

### *Lost Hills Operations and Maintenance Center*

Contract work (Specification No. 07-06) began in August 2007 to connect existing water and sewer lines to the Lost Hills Utility District lines and was essentially completed in November 2007. DWR acceptance is pending completion of all administrative items.

### *Teerink Pumping Plant*

Recoating of Discharge Lines 1 through 7 interiors began in January 2007 (Specification No. 06-25). Completion is expected in mid-2008.

## Tehachapi Division

### *Edmonston Pumping Plant*

A contract (Specification No. 02-10) to replace pump Units W2, W4, W6, and W8 began in June 2003 and continued throughout 2007, with completion scheduled for March 2011. Work consists of:

- designing, fabricating, and testing a four-stage pump model and a single-stage pump model, and furnishing a pump model test program report;
- designing, manufacturing, delivering, storing, and installing four pumps to replace existing pumps;
- furnishing spare parts, auxiliary equipment, tools, and templates;

- modifying existing pump foundations, if required, for the new pumps;
- applying coatings; and
- providing liaison services.

A contract (Specification No. 04-09) to furnish spare impellers and diffusers began in July 2004 and was completed in March 2007. Acceptance by DWR is not expected until 2008 due to outstanding submittals. Work consists of the manufacture and delivery of:

- two complete sets of pump impellers and two additional impellers;
- one complete set of diffusers;
- two complete sets of stationary and rotating wearing rings;
- one complete set of upper and lower wear plates;
- one complete set of interstage bushings; and templates.

## Mojave Division

### *Cedar Springs Dam Maintenance Station*

DWR awarded a contract (Specification No. 07-25) in December 2007 to construct a 14,400-square foot civil maintenance and mobile equipment building to replace the outdated Cedar Springs Dam Maintenance Subcenter. Work is expected to begin in January 2008 and be completed in mid-2010.

### *Horsethief Creek Bridge*

A contract (Specification No. 07-12) to build a new one-lane railroad flat car bridge over Horsethief Creek began in September 2007. The bridge will replace partially blocked culverts, provide a larger area for Horsethief Creek storm water to pass under the Mojave Siphon Maintenance Road, improve access from Mojave Siphon Powerplant to Check 66, and protect the nearby Mojave Siphon pipelines. Completion is expected in early 2008.



### ***Mojave Siphon Powerplant***

A contract (Specification No. 07-09) to furnish, install, and encase approximately 60 feet of 10 foot diameter steel pipe from the existing tee on Barrel Number 3 to the abandoned prestressed concrete cylinder pipe (Barrel Number 4) began in August 2007. The work also includes construction of a blowoff to allow drainage of the bypass line for maintenance activities. Completion is expected in May 2008.

### ***Tehachapi East Afterbay***

The Tehachapi East Afterbay project is located near the bifurcation of the East and West Branches of the California Aqueduct in southern Kern County to provide additional storage to the existing Tehachapi Afterbay (which is located in the Tehachapi Division). The principal features of the Tehachapi East Afterbay project include an inlet channel, isolation weir, reservoir, flow barrier, spoil embankment, outlet channel, bypass, drainage culvert, control building, improvements to the existing canal, and site work.

The contract (Specification No. 04-18) to furnish roller gates began in February 2005, was completed in January 2006, and was accepted in August 2007. Work included furnishing two roller gates with hydraulic actuators and one hydraulic power unit, metalwork, coatings, and electrical work.

The afterbay completion contract (Specification No. 05-03) began in May 2005 but was terminated for default in November 2005. The remaining work was divided among three contracts, two of which remained open in 2007, as follows.

- The completion Phase II contract (Specification No. 05-16) began in January 2006, and included the bypass facilities, control building, flow barrier, removal of Cofferdam No. 2, and miscellaneous roadwork. Work was

completed in June 2006 and accepted in April 2007.

- The completion Phase III contract (Specification No. 06-14), which began in August 2006, included the outlet channel completion, aqueduct plug, Cofferdam No. 1 removal, and site work. Work was completed in March 2007 and accepted in August 2007.

## **Santa Ana Division**

### ***East Branch Extension Phase I***

Construction of the East Branch Extension Phase I began with the issuance of a Notice to Begin Work on February 26, 1999, for pipeline Reaches 1 and 2. Phase I of the project is being constructed to convey 8,650 af of SWP water annually to the San Geronio Pass Water Agency service area, with provisions to provide San Bernardino deliveries to the Yucaipa Valley. Located in San Bernardino and Riverside counties, the project facilities will consist of existing pipelines, three new pipeline reaches, three new pump stations, and a new reservoir. The official groundbreaking ceremony took place in Yucaipa on August 23, 1999.

Below are brief descriptions of the remaining construction contracts.

***Pump Stations.*** Work began in November 1999 on the contract (Specification No. 99-17) to design, manufacture, shop test, and deliver three 4,500 gallons per minute (gpm) and one 9,000 gpm vertical turbine pumps for Greenspot Pump Station; two 4,500 gpm and one 9,000 gpm vertical turbine pumps for Crafton Hills Pump Station; and two 3,600 gpm vertical turbine pumps for Cherry Valley Pump Station. The contract calls for electric motors, variable frequency drives (VFDs), appurtenant equipment, and associated training programs. Completion of this contract was scheduled for December 2003, but was extended to September 2008 due to a change order

for additional pump units and related components for Greenspot and Crafton Hills pump stations. As of December 2007, the added units were complete except for erecting engineer services, which are expected to occur in 2009 during completion of Specification 06-21.

The contract (Specification No. 01-05) to furnish and install the control and communications systems for Greenspot, Crafton Hills, and Cherry Valley pump stations began in October 2001 and was completed in May 2004. Acceptance is expected in August 2008.

Work on a contract (Specification No. 06-21) to install spare units at Greenspot, Crafton Hills, and Cherry Valley pump stations, and to replace the existing control valves and unit discharge isolation valves for Greenspot Pump Station Units No. 1 through 4 began in October 2006. Work continued throughout 2007 and is expected to be completed in late 2009. The work includes:

- furnishing and installing a pump, motor, variable VFD, programmable logic controller (PLC) cubicle, and motor control center unit breaker assembly at Cherry Valley Pump Station;
- furnishing and installing switchgear at Greenspot and Crafton Hills pump stations;
- installing PLCs, valves, piping, tubing, fittings, hangers, supports, and appurtenances at all three pump stations;
- installing DWR-furnished pumps and motors at Greenspot and Crafton Hills pump stations;
- installing a DWR-furnished VFD at Greenspot Pump Station;
- removing existing valves, piping, and appurtenances; and
- manufacturing and delivering tools and spare parts to all three pump stations.

**Valves.** Three separate contracts (Specification Nos. 99-20, 99-22, and 99-23) were awarded to furnish East Branch Extension valves. Work began on all three contracts in 1999 and was essentially complete for Specification Nos. 99-20 and 99-23 in July 2001 and June 2001, respectively, and in December 2000 for Specification No. 99-22. Several corrective issues continued to be addressed throughout 2007. Project acceptance is expected in 2008.

### **Lake Perris State Recreation Area**

Repairs to the marina at Lake Perris State Recreation Area began in May 2006 (Specification No. 06-05) and were completed in September 2006. DWR accepted the project in February 2007.

A contract (Specification No. 06-28) to modify the existing Americans with Disabilities Act (ADA) fishing dock began in February 2007. Work included new concrete footings, installing 600 feet of ADA access ramp, building and installing a 50 foot dock section, and relocating two ramps and three platforms. Added work by change order included inspection and repair of an aerator and a new anchor system for the dock pedestals and columns. All work was completed in October 2007 and is expected to be accepted in March 2008.

### **Santa Ana Pipeline**

Phase IV of the excavation, inspection, and repair of the Santa Ana Pipeline began in November 2007 (Specification No. 07-23). Completion is expected in 2010.

### **West Branch**

#### **Gorman Creek Improvement Channel**

An emergency contract (Specification No. 07-03) began in January 2007 to remove and replace 1,000 feet of damaged concrete liner near Station 115, improve the liner foundation, inspect and patch approximately 11,000 feet of open channel, and remove

concrete and silt from Hungry Valley Siphon. The repairs, which were required to ensure scheduled West Branch water deliveries, were completed in February 2007. However, after flow resumed, inspections found that 11,000 feet of the channel upstream of Station 115 were in need of urgent repair. The additional repairs began in September and continued throughout 2007. Completion is expected in mid-2008.

### **Lower Quail Canal**

A contract (Specification No. 06-23) to control seepage on the Lower Quail Canal began January 2007, was completed in March 2007, and was accepted in July 2007. Work included:

- placing a seepage control blanket;
- installing drainage piping within the seepage control blanket; and
- placing compacted embankment.

### **Oso Pumping Plant**

Work began in December 2007 to construct a 14,400 square foot civil maintenance and mobile equipment building at Oso Pumping Plant (Specification No. 07-22). Work is expected to be completed in late 2009.

### **Peace Valley Pipeline**

A contract (Specification No. 07-21) to excavate, inspect, and encase pipe section numbers 774, 808, and 825 of the Peace Valley Pipeline began in October 2007 and was completed in December 2007. Acceptance is expected in early 2008.

## **Construction Activities in Multiple Divisions**

### **Banks Pumping Plant and Gianelli Pumping-Generating Plant**

A contract (Specification No. 02-12) began in May 2003 to design, manufacture, deliver, and install automatic digital voltage regulators for Banks Pumping Plant, Units 1

through 7 and Gianelli Pumping-Generating Plant, Units 1 through 8 and completed in March 2006. Contract acceptance is expected in mid-2008; however it may be delayed until completion of all contractor submittals.

### **Banks Pumping Plant, Dos Amigos Pumping Plant, and Coalinga Operations and Maintenance Subcenter**

A contract (Specification No. 06-03) to replace and recoat roofs at Banks Pumping Plant, Dos Amigos Pumping Plant, and Coalinga Operations and Maintenance Subcenter began in March 2006 and was completed in October 2006. The contract included added work to remove and replace roofing at the Sacramento Maintenance Facility. Acceptance is expected in early 2008.

### **Banks Pumping Plant, Skinner Fish Facility, and Roaring River Intake Structure**

Contract (Specification No. 06-12) work began in August 2006 to design, manufacture, test, deliver, and install cathodic protection at Banks Pumping Plant, Skinner Fish Facility, and the Roaring River intake structure. Added work included installation of a cathodic protection system at the Travis Surge Tank; installation of insulating unions and magnesium anodes at seven liquid propane gas tanks in Delta Field Division; installation of one union at the mobile equipment repair building; installation of magnesium anodes at six riser locations in Delta Field Division; and improvement of the cathodic protection system at the trashrack structure at the Skinner Fish Facility. Work was completed in December 2007. Acceptance is expected in early 2008.

### **Banks Pumping Plant and Teerink Pumping Plant**

A contract (Specification No. 06-27) to furnish spare coils and materials for Banks

Pumping Plant and Teerink Pumping Plant began in February 2007. Completion is expected in 2008.

### **California Aqueduct**

In July 2005, work began on a contract (Specification No. 05-07) to monitor, test, and repair copper communications cable and voice and data equipment along 440 miles of the California Aqueduct. DWR terminated the contract for convenience in October 2007.

### **Oroville, Delta, and San Luis Field Divisions**

In September 2007, work began on a contract (Specification No. 07-16) to seal and pave roads and parking areas in Oroville, Delta, and San Luis Field Divisions. Final inspections were held in December 2007, and completion is expected in 2008.

### **Oroville and Southern Field Divisions**

Work began in September 2005 to seal and pave roads in the Oroville and Southern Field Divisions (Specification No. 05-11). Work was completed in April 2007; acceptance is expected in early 2008. The following work was added by change order:

- flood damage repair—Oroville Wildlife Area (Oroville Field Division);
- excavation, paving, guardrail and drainage work, and miscellaneous work (Oroville Field Division);
- erosion repair—Angeles Tunnel north adit access road (Southern Field Division);
- removal of roadway and culverts, relocation of utilities, regrading of flood channel—downstream of Devil Canyon Powerplant (Southern Field Division);
- road repair—Lower Quail Lake Canal and Oso Canal (Southern Field Division);
- installation and repair of irrigation system—Perris Lake State Recreation Area (Southern Field Division);
- installation of monitoring wells—Peace Valley Pipeline (Southern Field Division);

- modular office trailer—Pearblossom Operations and Maintenance Center (Southern Field Division); and
- roadway and culvert repair—Old Ferry Road (Delta Field Division).

### **San Luis and Southern Field Divisions**

In August 2004, work began on a contract (Specification No. 04-10) to seal and pave roads in the San Luis and Southern Field Divisions. The contract was completed in August 2005; however, acceptance is not expected until early 2008. Added work included:

- emergency repairs due to storm damage: Osito adit channel, Piru Creek embankment, Devil Canyon Powerplant access road, Smokey Bear Road, and the Angeles Tunnel south adit access road (Southern Field Division);
- installation of anode beds and repairs to cathodic protection test stations (Southern Field Division);
- providing a temporary office and a soils/concrete laboratory building—Tehachapi East Afterbay (Southern Field Division); and
- sealing and paving roads—fog seal, asphalt dikes, fill, drain inlets (Southern Field Division).

A contract (Specification No. 06-15) to seal and pave roads in San Luis and Southern Field Divisions began in July 2006, and was completed in February 2007. Acceptance is expected in early 2008. Added work included:

- road resurfacing – McCabe Road (San Luis Field Division);
- installation of drainage and headwalls, regarding, and paving – vicinity of Ritter Siphon (Southern Field Division); and
- placement of a dumpster pad and preparing parking lot for paving – Vista Del Lago Visitors Center (Southern Field Division).

### ***Southern Field Division***

In September 2007, work began on a contract to seal and pave roads and parking areas at the Southern Field Division (Specification No. 07-17). Completion is expected in early 2008.

### ***Warne Powerplant and Devil Canyon Powerplant***

A contract (Specification No. 01-13) to furnish spare coils for Warne Powerplant and for Devil Canyon Powerplant began in October 2001 and completed in February 2006. Acceptance is expected in mid-2008. Change order work included:

- furnishing and delivering a set of serge rings with support and insulation blocks;
- substitution of stator bars in lieu of stator coils; and
- furnishing and delivering an additional set of stator windings.

### **Miscellaneous Construction Activities**

The following non-SWP construction activities are categorized as miscellaneous.

#### ***Demonstration Aeration Facility***

A contract (Specification No. 05-06) to install a demonstration aeration facility on Dock 20 at Rough and Ready Island in the Port of Stockton began in December 2005 and continued through 2007. Work includes installing:

- two 30-inch diameter steel U tube casings and two 20-inch diameter U tubes;
- 24-inch steel piping and 30-inch high-density polyethylene diffuser piping;
- two vertical turbine pump-motor units;
- four fish screens with two air burst systems; and
- electrical items including a PLC, water flow meter, instrumentation, and distribution panel and meter.

Added work includes:

- decommissioning an existing meteorological tower and installing a new tower;
- modifications to the initial design;
- additional coatings;
- providing and installing a liquid oxygen storage tank and distribution system;
- removing and replacing asphalt and concrete; and
- purchasing a storage container.

#### ***Detention Basin Excavation and Stockpile***

A contract (Specification No. 07-19) to excavate a detention basin and stockpile and seed the excavated material in the City of Woodland began in September 2007 and was completed in December 2007. Acceptance is expected in late 2007.

#### ***Emergency Flood Response***

The following two emergency contracts were awarded to respond to flooding at the listed locations.

#### ***Sacramento-San Joaquin Delta and Suisun Marsh.***

The work for this contract (Specification No. 06-01) began in January 2006, was completed in May 2007, and was accepted in August 2007. Work included placing rip-rap, rock, sand, and fill; relocating flood response supplies; and restoring levees.

***San Joaquin River.*** Contract (Specification No. 06-20) work began in April 2006, was completed in December 2006, and was accepted in July 2007. Work included levee repairs and construction of filter berms.

#### ***Emergency Levee Erosion Repairs***

The contracts listed below provided emergency levee erosion repairs and included most or all of the following work:

- fencing;

- removal of trees, brush, and debris;
- levee repairs;
- placement of in-stream woody material; and
- planting, seeding, and irrigation.

***Cache Slough Miles 16.5L and 21.8R, Steamboat Slough Mile 16.2R, and Sacramento River Miles 20.8L, 26.5L, and 32.5R.***

Specification No. 06-17 began in July 2006 and continued throughout 2007. Completion is expected in May 2008.

***Sacramento River Mile 85.6R and Bear River Miles 2.4L and 10.1R.*** Specification No. 06-16 began in June 2006 and continued throughout 2007. Completion is expected in mid-2008.

***Sacramento River Miles 56.8R and 69.9R.*** Specification No. 06-18 began in July 2006 and continued through 2007. Project completion is expected in mid-2008.

***Sacramento River Miles 130.8R, 141.4R, 145.9L, 154.5R, and 164.0R.*** Specification No. 06-19 began in July 2006 and continued throughout 2007. Added work at two additional sites (Sacramento River Miles 99.5R and 182.0R) will likely extend completion to mid-2008.

***Phase II Bear River Mile 1.2L and Sacramento River Miles 99.5R and 182.0R.*** Specification No. 07-10 began in July 2007, and was complete, except for the plant establishment period, by December 2007. Completion is expected in mid-2009.

***Phase II Sutter Slough Miles 24.8L and 25.4R and Sacramento River Miles 70.7R, 71.7R, and 73.0R.*** Specification No. 07-13 began in August 2007 and completion is expected in mid-2009.

### ***Levee Setback***

A contract (Specification No. 06-13) to construct a levee setback at Cache Creek North Levee Miles 0.8, 1.1, and 2.4

began in June 2006, was completed in September 2006, and was accepted in July 2007. Work included:

- removing trees, clearing, and grubbing;
- constructing the levee setback;
- paving roads;
- excavating a notch in the existing levee;
- constructing a new road and new levee ramps; and
- fabricating and installing a gate, providing a diesel generator, relocating an irrigation line, and shaping two levee notches.

### ***Restore Habitat and Public Access***

Phase I (Specification No. 06-22) of the San Joaquin River restoration at Jensen River Ranch began in November 2006 and was completed in March 2007. The work included:

- removal of selected irrigation lines, structures, and trees;
- site work and earthwork; and
- installing a storm drain bypass and an irrigation system.

Phase II (Specification No. 07-11) of the restoration began in August 2007 and was completed in December 2007. Acceptance is expected in 2008. Work included:

- selective demolition;
- site work;
- construction of a potable waterline, an oxbow embankment, a storm drain bypass tie-in, corrugated metal pipe culverts, fencing, and gates; and
- plantings and drip irrigation.

### ***Rock Conveyor System***

The design, fabrication, transport, assembly, and demonstration of a rock conveyor system at the Port of Stockton began in November 2007 (Specification No. 07-24).

Completion is expected in mid-2008. After completion, the conveyor system will be covered, transported to the Port of Stockton, and stored for future use.

### **Sediment Removal**

Work began in July 2006 on a contract (Specification No. 06-08) to excavate and dispose of sediment material from the Yolo Bypass. The work was completed in October 2006 and accepted in June 2007.

In August 2007, removal of approximately 1.8 million cubic yards of sediment from Tisdale Bypass began (Specification No. 07-14). The work was complete in December 2007. Acceptance is expected in early 2008.

### **Real Estate Branch Activities**

DWR has spent a net total of \$251.5 million to acquire rights-of-way, recreation, and mitigation land for the SWP from its inception to December 31, 2007. DWR conducted the following real estate activities from January 1 through December 31, 2007:

- acquired four parcels (129.99 acres in permanent easement and 12.08 acres in temporary easement) for \$495,703 for the South Bay Aqueduct Improvement Project and the Cache Creek North Levee Repair;
- renewed eleven leases and added one new lease on SWP properties;
- managed leasing activities of SWP non-operating properties, which produced an income of \$350,891;
- processed 22 encroachment permit applications and issued 18;
- collected fees of \$149,247 for review and inspection costs related to encroachment permit applications;
- received eight encroachment reviews where applicant had prior property rights;
- coordinated review of 24 tentative tract map developments within 1 mile of the California Aqueduct;
- completed 14 appraisals covering 28 parcels and 5 rental rate appraisals on 9 parcels;
- completed one cost estimate covering 250 parcels for the Delta Habitat Conservation and Conveyance Project;
- completed one right-of-entry for the Horse Thief Creek Remediation Project;
- completed three Agreements for Compensation and one Agreement for Transfer of Control for the South Bay Aqueduct Project.

In addition, DWR obtained 28 temporary permits, including:

- one for the New Hope Tract Phase II Mitigation Project;
- one for the Brushy Creek Pipeline;
- one for the water quality monitoring program;
- one for the Temporary Barriers Project;
- seven for East Branch Extension, Phase II;
- two for South Delta Improvements Program, Permanent Barriers; and
- two for Crafton Hills Reservoir.

**Table 12-1 Design Activities, January 1, 2007, through December 31, 2007, by Division**

Division and Facility	Design Activity	Date Design Began	Design Actual/ Estimated Completion Date
<b>Delta Field Division</b>			
South Bay Aqueduct Enlargement (subcomponents below)			
South Bay Pumping Plant	Furnish power transformers (rebid)	December 2003	February 2007
	Furnish and install SCADA equipment	February 2004	October 2007
	Furnish valves, actuators, and hydraulic power unit	July 2003	November 2009
	Furnish 45 cfs pumps and motors	March 2003	February 2007
	Construct a 69kV transmission and switchyard	October 2006	May 2008
	Plant completion	January 2005	October 2007
	Plant discharge line and Brushy Creek Pipeline No. 3	May 2003	October 2006
Surge Tank No. 3	Construct new surge tank	July 2004	July 2009
Canal	Canal modification	July 2003	July 2008
Dyer Reservoir	Construct a new 425 af reservoir	September 2003	June 2008
Banks Pumping Plant	Hillside improvement	October 2006	November 2008
Patterson Reservoir	Raise embankment and refurbish liner	January 2006	May 2008
Permanent barriers—South Delta Improvements Program	New operable barriers—4 sites	September 2003	August 2009
Fish screens at Sherman and Twitchell Islands	New fish screens at existing siphons—10 sites	September 2007	March 2008
Skinner Fish Facility	Delta smelt refugium culture facility	September 2007	January 2008
Port of Stockton	Rock conveyor system	July 2007	March 2008
<b>Oroville Field Division</b>			
Hyatt Powerplant	Pump—turbine refurbishment, Units 2, 4, and 6	March 2000	September 2007
<b>San Joaquin Field Division</b>			
Edmonston Pumping Plant	Furnish spare impellers and diffusers, Units E1, E3, E5, E7, E9, E11, and E13	March 2004	January 2007
Edmonston Pumping Plant	Pump replacement, Units W2, W4, W6, and W8	August 2001	March 2011
Edmonston, Teerink, Chrisman, Buena Vista	Replace septic tanks and sewer piping	August 2007	September 2009
Lost Hills Operations and Maintenance Center	Domestic and fire water supply	January 2005	December 2007
Teerink Pumping Plant	Recoat discharge lines interior	December 2005	June 2009
<b>San Luis Field Division</b>			
Canal liner repair	Remove and replace damaged concrete liner	May 2007	August 2007
Dos Amigos Pumping Plant	Replace trashracks and trashrake	August 2007	September 2010
Gianelli Pumping-Generating Plant	Evaluation of existing heating ventilation and air conditioning system	August 2007	March 2008
	Replacement of eight 156-inch butterfly valves	August 2008	June 2012
East Branch Extension—Phase I Improvements	Project planning and engineering feasibility studies for the Crafton Hills Reservoir enlargement	December 2006	June 2008
East Branch Extension—Phase II	Project planning and engineering feasibility studies	March 2007	September 2009



**Table 12-1 Design Activities, January 1, 2007, through December 31, 2007, by Division**

Division and Facility	Design Activity	Date Design Began	Design Actual/ Estimated Completion Date
Perris Dam	Dam remediation	January 2007	September 2010
Perris Dam	Tower retrofit	February 2008	February 2009
Perris Dam	Emergency outlet extension	January 2007	July 2010
<b>Southern Field Division</b>			
Lower Quail Canal	Seepage control blanket	May 2006	January 2007
Vista del Lago Visitor's Center	Erosion repair and water line replacement	July 2007	March 2009
Oso Pumping Plant and Cedar Springs Dam Maintenance Station	Civil maintenance and mobile equipment buildings	May 2005	March 2007
<b>Multiple Divisions</b>			
Sacramento River Mile 85.6R and Bear River Miles 2.4L and 10.1R	Emergency levee erosion repair	June 2006	February 2008
Sacramento River Miles 56.8R and 69.9R	Emergency levee erosion repair	July 2006	February 2008
Sacramento River Miles 130.8R, 141.4R, 145.9L, 154.5R, and 164.0R	Emergency levee erosion repair	July 2006	February 2008

**Table 12-2 Construction Activities, January 1, 2007, through December 31, 2007, by Division**

Construction Division and Facility	Construction Contract (Specification Number)	Starting Date (NTBW <sup>a</sup> )	Acceptance Date (Expected or Actual)	Contract Costs (In Thousands of Dollars)
<b>Upper Feather River Division</b>				
Grizzly Valley Dam and Reservoir	Lake Davis fish containment (06-11)	June 2006	March 2008	1,590
<b>Oroville Division</b>				
Hyatt Powerplant	Refurbish pump-turbine Units 1, 3, and 5 (98-22)	February 1999	February 2008	10,089
	Refurbish pump-turbine Units 2, 4, and 6 (01-11)	November 2001	February 2008	15,966
<b>Delta Facilities</b>				
Middle River, Old River, and Grant Line Canal	Temporary rock barriers multiyear contract (2004–2006) (03-07)	November 2003	June 2007	17,656
	Temporary rock barriers multiyear contract (2007–2009) (06-26)	January 2007	February 2010	9,327
<b>Suisun Marsh Facilities</b>				
Roaring River Slough, Station 370+20 and 417+20	Emergency levee restoration (06-02)	January 2006	December 2007	2,100
<b>North Bay Aqueduct</b>				
Napa Turnout Reservoir	Reservoir replacement (07-01)	April 2007	May 2009	11,080
<b>South Bay Aqueduct</b>				
Dyer Reservoir	Drainage diversion (06-24)	September 2006	June 2008	762
South Bay Pumping Plant	Furnish 45 cfs pump and motor units and one spare pump motor (04-05)	November 2004	March 2009	7,170
	Furnish valves, actuators, and hydraulic power units (04-20)	May 2005	March 2009	2,178
	Furnish switchyard equipment (05-10)	September 2005	March 2009	1,471
	Furnish 5 kV switchgear (05-05)	October 2005	March 2009	2,996
	Construct initial pumping plant facilities (06-04)	August 2006	February 2008	14,004
	Furnish power transformers (07-02)	March 2007	November 2009	5,070
	Complete pumping plant (07-18)	December 2007	June 2009	9,833
	Discharge line and Brushy Creek Pipeline No. 3 (06-09)	December 2006	August 2008	27,191
<b>San Luis Division</b>				
Gianelli Pumping-Generating Plant and Dos Amigos Pumping Plant	Refurbish CO <sub>2</sub> system (04-08)	July 2004	June 2008	1,696
Gianelli Pumping-Generating Plant, Dos Amigos Pumping Plant, Coalinga Operations and Maintenance Subcenter, Check Sites, and Flowmeter Sites	Replace standby engine generators (06-10)	August 2006	January 2010	2,525
San Luis Canal	Restore West Side Detention Basin (04-03)	August 2004	July 2008	7,276
	Canal lining repair, Milepost 56.40 to 164.90 (07-20)	November 2007	September 2008	3,296
<b>South San Joaquin Division</b>				
Buena Vista Pumping Plant	Furnish spare coils and materials (07-05)	June 2007	July 2009	4,800
Lost Hills Operations and Maintenance Center	Water and sewer service connection (07-06)	August 2007	February 2008	339

**Table 12-2 Construction Activities, January 1, 2007, through December 31, 2007, by Division**

Construction Division and Facility	Construction Contract (Specification Number)	Starting Date (NTBW <sup>a</sup> )	Acceptance Date (Expected or Actual)	Contract Costs (In Thousands of Dollars)
Teerink Pumping Plant	Recoat discharge lines interior (06-25)	January 2007	June 2008	5,830
<b>Tehachapi Division</b>				
Edmonston Pumping Plant	Replace pumps, Units W2, W4, W6, and W8 (02-11)	June 2003	March 2011	32,900
	Impeller replacement (04-09)	July 2004	March 2007	4,300
<b>Mojave Division</b>				
Cedar Springs Dam Maintenance Station	Construct civil maintenance and mobile equipment building (07-25)	July 2007	March 2009	2,781
Horsethief Creek Bridge	Construct bridge (07-12)	September 2007	March 2008	1,737
Mojave Siphon Powerplant	Penstock bypass connection line (07-09)	August 2007	March 2008	1,535
Tehachapi East Afterbay	Furnish roller gates (04-18)	February 2005	August 2007	640
	Complete Afterbay Phase II (05-16)	January 2006	April 2007	15,814
	Complete Afterbay Phase III (06-14)	August 2006	August 2007	10,871
<b>Santa Ana Division</b>				
East Branch Extension Phase I				
Greenspot, Crafton Hills, and Cherry Valley Pump Stations	Furnish pumps, motors, and variable frequency drives (99-17)	November 1999	March 2008	4,748
	Furnish and install supervisory control and communications systems (01-05)	October 2001	August 2008	4,449
	Furnish and install additional units (06-21)	October 2006	September 2008	4,272
Valve facilities, various locations				
	Furnish ANSI ball valves (99-20)	October 1999	May 2008	1,074
	Furnish AWWA butterfly valves (99-22)	October 1999	May 2008	733
	Furnish ANSI butterfly valves (99-23)	November 1999	May 2008	1,213
Lake Perris State Recreation Area	Repair marina (06-05)	May 2006	February 2007	331
	ADA fish dock modifications (06-28)	February 2007	February 2008	886
Santa Ana Pipeline	Excavate, inspect, and repair, Phase IV (07-23)	November 2007	January 2008	975
<b>West Branch</b>				
Gorman Creek Improvement Channel	Emergency repair (07-03)	January 2007	March 2008	3,000
Lower Quail Canal	Seepage control blanket (06-23)	January 2007	July 2007	657
Oso Pumping Plant	Construct civil maintenance and mobile equipment building (07-22)	December 2007	March 2009	2,811
Peace Valley Pipeline	Excavate, inspect, and repair (07-21)	October 2007	March 2008	1,130
<b>Multiple Divisions</b>				
Banks Pumping Plant and Gianelli Pumping-Generating Plant	Design, manufacture, deliver, and install digital voltage regulators (02-12)	May 2003	January 2008	2,082
Banks Pumping Plant, Dos Amigos Pumping Plant, and Coalinga Operations & Maintenance Subcenter	Replace and recoat roofs (06-03)	March 2006	February 2008	1,732
Banks Pumping Plant, Skinner Fish Facility, and Roaring River Intake Structure	Rehabilitation of cathodic protection anodes (06-12)	June 2006	February 2008	314
Banks Pumping Plant and Teerink Pumping Plant	Furnish spare coils and materials (06-27)	February 2007	July 2008	1,680

**Table 12-2 Construction Activities, January 1, 2007, through December 31, 2007, by Division**

Construction Division and Facility	Construction Contract (Specification Number)	Starting Date (NTBW <sup>a</sup> )	Acceptance Date (Expected or Actual)	Contract Costs (In Thousands of Dollars)
California Aqueduct	Monitor, test, and repair copper communications equipment (05-07)	July 2005	Terminated for convenience October 2007	526
Oroville, Delta, and San Luis Field Divisions	Seal and pave roads and parking areas—2007 (07-16)	September 2007	February 2008	3,039
Oroville and Southern Field Divisions	Seal and pave roads (05-11)	September 2005	February 2008	6,556
San Luis and Southern Field Divisions	Seal and pave roads—2004 (04-10)	August 2004	January 2008	6,473
Southern Field Division	Seal and pave roads—2006 (06-15)	July 2006	January 2008	3,927
	Seal and pave roads and parking areas—2007 (07-17)	September 2007	February 2008	2,085
Warne and Devil Canyon Poweplants	Furnish spare coils and materials (01-13)	October 2001	February 2008	1,787
<b>Miscellaneous Activities</b>				
Bear River Mile 1.2L and Sacramento River Miles 99.5R and 182.0R	Emergency levee erosion repair—Phase II (07-10)	July 2007	November 2008	5,500
City of Woodland	Detention basin excavation and stockpile—State emergency erosion repair project (07-19)	September 2007	November 2007	298
Port of Stockton, Rough and Ready Island Dock 20	Install demonstration aeration facility (05-06)	December 2005	March 2008	4,066
Port of Stockton	Rock conveyor system (07-24)	November 2007	May 2008	911
Cache Creek Levee Mile 0.8, 1.1, and 2.4	North levee setback (06-13)	June 2006	July 2007	673
Cache Slough Miles 16.5L and 21.8R, Steamboat Slough Mile 16.2R, Sacramento River Miles 20.8L, 26.5L, and 32.5R	Emergency levee erosion repair (06-17)	July 2006	February 2008	45,168
Jensen River Ranch	San Joaquin River Restoration, Phase I (06-22)	November 2006	February 2008	1,412
	San Joaquin River Restoration, Phase II (07-11)	August 2007	December 2007	527
Sacramento River Mile 85.6R and Bear River Miles 2.4L and 10.1R	Emergency levee erosion repair (06-16)	June 2006	August 2008	19,223
Sacramento River Miles 56.8R and 69.9R	Emergency levee erosion repair (06-18)	July 2006	August 2008	8,875
Sacramento River Miles 130.8R, 141.4R, 145.9L, 154.5R, and 164.0R	Emergency levee erosion repair (06-19)	July 2006	August 2008	42,269
Sacramento-San Joaquin Delta, and Suisun Marsh	Emergency flood response (06-01)	January 2006	August 2007	2,685
San Joaquin River	Emergency flood response (06-20)	April 2006	July 2007	3,681
Sutter Slough Miles 24.8L and 25.4R and Sacramento River Miles 70.7R, 71.7R, and 73.0R	Emergency levee erosion repair (07-13)	July 2007	November 2008	4,942
Tisdale Bypass	Sediment removal (07-14)	August 2007	February 2008	7,523
Yolo Bypass	Sediment removal (06-08)	July 2006	June 2007	5,949

<sup>a</sup> Notice to Begin Work



## Chapter 13 Recreation

*Lime Saddle, Lake Oroville State Recreation Area.*

## Significant Events in 2007

The Department of Fish and Game (DFG) continued its fish planting activities at 11 of the 12 State Water Project (SWP) facilities. A total of 574,030 salmonids were planted: 417,330 trout and 156,700 salmon. Lake Oroville was planted with 133,758 coho, while Lake del Valle was planted with 10,000 Chinook and 12,932 much-desired kokanee. Additionally, Lake Perris was planted with 300 trophy-sized rainbow trout to attract more anglers.

SWP facilities supported an estimated 4.7 million recreation days of use, about the same as in 2006 and 2005.

This was the third year that the Department of Water Resources (DWR) and partner agencies scheduled Catch A Special Thrill (C.A.S.T.) events at SWP recreation lakes. Four of the SWP lakes hosted these events (Lake Oroville, Lake del Valle, Castaic Lake, and Lake Perris). More than 300 volunteers, many of them DWR employees, helped make these events a great day for 140 disabled and disadvantaged children.

*Information for this chapter was provided by the Division of Integrated Regional Water Management, Public Affairs Office, Division of Environmental Services, and the State Water Project Analysis Office.*

The State Water Project (SWP) is a multipurpose project that provides recreational benefits to millions of Californians. In addition to providing water supply, flood control, and habitat for fish and wildlife, the SWP offers extensive and varied recreational opportunities—tours, sightseeing, fishing, hunting, picnicking, camping, boating, water skiing, bicycling, hiking, and swimming. Under the Davis-Dolwig Act (DDA), these recreational opportunities, as well as fish and wildlife enhancements, are not allocable as water and power costs to the SWP water contractors. They are financed by Department of Water Resources' (DWR) existing authorities under the Burns-Porter Act as well appropriations from the Legislature specifically for these purposes.

## Recreation Areas

The SWP has 37 developed recreation areas, or sites, throughout California, including 18 developed fishing access sites. Figure 13-1 shows the name and location of each area.

## Recreation Use

In 2007, SWP facilities supported an estimated 4.7 million recreation days of use (Table 13-1), about the same as in 2006 and 2005. A recreation day is defined as one individual user visiting a recreation site along the SWP within all or part of a one-day period. Recreation usage increased significantly at Lake del Valle, Silverwood Lake, and Castaic Lake in 2007. Usage decreased at Lake Perris, where the lake level was lowered because of seismic safety risks in the foundation of Perris Dam. Recreation use at the fishing access sites and along the California Aqueduct Bikeway nearly equaled that of 2006.

Most SWP recreation use is concentrated at the major reservoirs, with 33 percent occurring at the lakes in the Oroville Field Division, and 44 percent of the total SWP recreational use in 2007 occurring at the four major reservoirs in Southern California: Pyramid Lake, Castaic Lake, Silverwood Lake, and Lake Perris. Since the SWP began delivering water in 1962, approximately

195 million recreation days have been recorded at SWP recreational facilities. In addition to recreation use, visitation at DWR's three SWP educational visitors centers totaled:

- Lake Oroville Visitors Center, 76,600 recreation days;
- Romero Overlook Visitors Center, San Luis Reservoir, 107,200 recreation days; and
- Vista del Lago Visitors Center, Pyramid Lake, 117,000 recreation days.

Overall, recreation usage of 4.7 million recreation days at the 16 SWP reservoirs listed in Table 13-1 contributed significantly to the 69.0 million (during calendar year 2007) day-use visitors at the 278 units of the California State Park System in fiscal year (FY) 2007–2008.

## Facilities

### Planning

During 2007, the following improvements to SWP facilities were planned:

#### *Lake del Valle State Recreation Area*

- East Bay Regional Parks is making plans to install a new 300,000-gallon steel bolted water storage tank on the west side of the lake.



Figure 13-1 Names and Locations of SWP Recreation Areas



**Table 13-1 Recreation Days Estimated<sup>a</sup> in 2007, by Field Division and Facility**

Field Division and Facility	Number of Recreation Days (rounded)
<b>Oroville Field Division</b>	
Frenchman Lake	65,600e
Antelope Lake	17,200e
Lake Davis	20,800e
Lake Oroville and Thermalito Forebay	1,030,500
Thermalito Afterbay and Oroville Wildlife Area	350,500
Feather River Fish Hatchery	155,700
Lake Oroville Visitors Center	76,600
<i>Subtotal</i>	<i>1,716,900</i>
<b>Delta Field Division</b>	
Lake del Valle	314,600
Bethany Reservoir	24,900e
Fishing Access Sites:	
Niels Hansen	100e
California Aqueduct:	
Walk-in fishing	600e
Bikeway	100e
White Slough Wildlife Area	11,300e
<i>Subtotal</i>	<i>351,600</i>
<b>San Luis Field Division</b>	
San Luis Reservoir SRA, includes San Luis Reservoir, O'Neill Forebay, and Los Banos Reservoir	471,600
Romero Overlook Visitors Center	107,200
California Aqueduct:	
Walk-in fishing	12,000e
Wildlife Areas	11,000e
<i>Subtotal</i>	<i>601,800</i>
<b>San Joaquin Field Division</b>	
Fishing Access Sites:	
Kettleman City	1,000e
Lost Hills	1,000e
Buttonwillow	1,000e
California Aqueduct:	
Walk-in fishing	9,500e
<i>Subtotal</i>	<i>12,500</i>
<b>Southern Field Division</b>	
Silverwood Lake	436,700
Lake Perris	678,900
Pyramid Lake	118,400
Vista del Lago Visitors Center	117,000
Castaic Lake	658,400
Fishing Access Sites:	
Quail Lake	1,300e
77th Street East	100e
Longview Road	100e
California Aqueduct:	
Walk-in fishing	1,300e
Bikeway	500e
<i>Subtotal</i>	<i>2,012,700</i>
<b>Total for Recreational Centers</b>	<b>4,394,700</b>
<b>Total for Visitors Centers</b>	<b>300,800</b>
<b>Grand Total</b>	<b>4,737,100</b>

<sup>a</sup> These values are provided by numerous sources and vary in their degree of accuracy. Recreation days are based on counts except where marked "e," which are based on partial data.

- The California Department of Boating and Waterways is planning to install an American with Disabilities Act (ADA) compliant dock on the west side of the lake in 2008.

### **San Luis Reservoir State Recreation Area**

Six new vaulted toilets and upgrade of existing four wind-warning light systems are planned for 2008 (DWR).

### **New Facilities**

During 2007, new facilities were completed at the following sites:

#### **Lake del Valle State Recreation Area**

East Bay Regional Parks installed a 300,000-gallon steel bolted water storage tank on the east side of the lake.

#### **San Luis Reservoir State Recreation Area**

DWR built five new ADA-compliant restroom facilities. These were installed at the Basalt and San Luis Creek areas along the ADA walkway. A new boat dock was also installed at Los Banos Creek.

#### **Silverwood Lake State Recreation Area**

DBW funded the installation of a new boat dock at the marina launch ramp. Construction was completed in 2007.

### **Improvements to Facilities**

During 2007, improvements were made at the following facility:

#### **Silverwood Lake State Recreation Area**

DBW provided funding for improvements to the Chamise and Sycamore Landing boat-in day use facilities. Construction will be completed in 2008.

## Oroville Recreation Plan

The Oroville Facilities, including Lake Oroville State Recreation Area, Oroville Wildlife Area, and adjacent DWR facilities are operated in conformance with the 1993 Amended Recreation Plan that was approved by the Federal Energy Regulatory Commission (FERC) in their 1994 Order 2100-054. In 2006, and consistent with their respective Davis-Dolwig Act (DDA) roles and responsibilities, DWR and its Settlement Agreement (SA) signatories submitted a new, collaboratively developed Settlement Agreement Recreation Management Plan (SARMP, March 2006) for FERC approval. This approval is expected sometime in 2011 or later, pending a new FERC license.

Additional need-based recreation improvements identified and proposed in the SARMP are anticipated to be constructed when FERC issues new license terms and conditions. The new terms and conditions are expected to be consistent with the proposed SARMP. In the meantime, DWR and its DDA collaborating partners, the Department of Parks and Recreation (DPR), the Department of Boating and Waterways (DBW), and the Department of Fish and Game (DFG), will continue to operate Oroville Facilities recreational installations consistent with the existing FERC license.

## Fish Planting

In 2007, DFG continued fish planting at SWP facilities, including all major SWP reservoirs. A total of 574,030 salmonids were planted, of which 417,330 were trout and 156,700 were salmon. Lake Oroville was planted with 133,758 coho, while Lake del Valle was planted with 10,000 Chinook and 12,932 much-desired kokanee, neither of which had been planted in 2006. Also new this year, DFG planted 300 trophy-sized rainbow trout in Lake Perris to attract more anglers. See Table 13-2.

## SWP Deliveries for Recreation

DWR has an agreement with DPR to provide onshore recreation water at several SWP facilities in an amount prorated to the yearly SWP Table A allocation. These deliveries are made pursuant to the DDA at no cost to DPR and while stipulating reimbursement from the State to DWR for these water supply deliveries, as allocated under DWR's joint SWP cost allocation. Per the 2007 60 percent SWP Table A allocation, maximum diversion amounts under the onshore recreation agreement were allocated at 60 percent, or a total of 4,068 af as follows: 1,650 af at San Luis Reservoir; 240 af at Lake del Valle; 1,398 af at Castaic Lake/Lagoon; 750 af at Lake Perris; and 30 af at Bethany Reservoir.

Actual deliveries under the agreement totaled 1,045 af as follows: 15 af at San Luis Reservoir; 138 af at Lake Del Valle; 196 af at Castaic Lake; 696 af at Lake Perris; and 0 af at Bethany Reservoir. In addition, 103 af was delivered to DPR at Silverwood Lake and 6 af to the U.S. Forest Service at Pyramid Lake. Further detail on these deliveries is provided in Table 9-4 of Chapter 9, Water Contracts and Deliveries.

## Recreation Financing

Prior to 2001, DWR reported capital costs allocated to fish and wildlife enhancement and recreation in Appendix D to Bulletin 132, *Costs of Recreation and Fish and Wildlife Enhancement*. This report is no longer mandated by the Legislature, and these capital costs, starting with FY 2000-2001, are reported in this bulletin.

The approach to financing recreation and fish and wildlife enhancement in connection with the SWP is provided in the DDA (California Water Code Sections 11900-11925, 1961); the Burns-Porter Act (CWC Section 12937, 1959); and CWC Sections as early as 1953

**Table 13-2 Fish Planted by Department of Fish and Game in 2007 (Thousands)**

Location and Size	Eagle Lake Trout	Brook Trout	Rainbow Trout	Coho Salmon	Chinook Salmon	Kokanee Salmon	Total For Lake
Antelope Lake Catchables	5.3	7.5	12.7				25.5
Lake Davis Catchables	31.2						31.2
Frenchman Reservoir Fingerlings			88.0				126.4
	38.4						
Lake Oroville Catchables				133.8			133.8
Thermalito Forebay Catchables	1.5		22.6				24.1
Lake del Valle Fingerlings					10.0	12.9	51.5
	6.4		22.1				
Los Banos Reservoir Catchables	11.3		7.2				18.5
Pyramid Lake Catchables			30.5				30.5
Castaic Lake Catchables			20.8				20.8
Castaic Lagoon Catchables			55.1				55.1
Silverwood Lake Catchables	6.2		11.6				17.8
Lake Perris Catchables	3.8		34.9				39.0
			0.3				
California Aqueduct	- - - - -	- - - - -	- - - - -	No Fish Planted	- - - - -	- - - - -	- - - - -
<b>Total</b>	<b>104.1</b>	<b>7.5</b>	<b>305.8</b>	<b>133.8</b>	<b>10.0</b>	<b>12.9</b>	<b>574.0</b>

(12581, 12582, 233, 345, 346), which declare recreation at the SWP to be a benefit to all the people of California and a cost that is to be borne by them. While this intent is cited in the DDA, no specific appropriation or funding source was defined. Consequently, Assembly Bill (AB) 12 in 1966, Senate Bill (SB) 1268 in 1970, and the Environmental Water Act, AB 1441 and AB 1442 in 1989, were all enacted to provide the statutorily required State funding for this SWP purpose.

As noted above, the Legislature has appropriated monies to meet State obligations to fund fish and wildlife enhancements and recreation at the SWP intermittently in the past. AB 12 appropriated \$5 million per year to DWR from tidelands oil and gas revenues, which totaled \$90 million through the early 1980s when these revenues were exhausted; SB 1268 appropriated \$55 million to DPR and \$5 million to DFG specifically for their responsibilities under the DDA at SWP facilities. Finally, AB 1442 appropriated a total of \$172 million to reimburse DWR for SWP Recreation and Fish and Wildlife Enhancement (R&FWE) costs incurred over the roughly previous dozen years as an offset to DWR's outstanding California Water Fund repayment, and an additional \$30 million for SWP R&FWE through 1994.

While no other appropriations to DWR for SWP R&FWE have been made by the Legislature, DWR has used its authority under the Burns-Porter Act to carry out and fund all SWP project purposes, including R&FWE, with State Water Resources Development System revenues.

### Capital Cost Allocations

Table 13-3 shows capital costs allocated to R&FWE and overall costs of lands acquired for recreation development through calendar year 2007. Total capital costs increased by \$15,406,313 since Bulletin 132-07 due to an increase of \$1,491,198

in 2007, and \$13,915,115 in years prior to 2007 due to historical adjustments. Reporting adjustments are for actual capitalized planning costs for facilities not yet constructed. These costs are budgeted by DWR from funds available for financing project construction costs. Specific (i.e., 100 percent) R&FWE costs not reported in this table are budgeted and funded by several other State departments with statutorily defined roles and responsibilities in the DDA, and these costs are financed by appropriations to these departments from a variety of funds.

### Accrued Interest Charges

Table 13-4 details accrued interest charges included in the costs shown in Table 13-3, and reimbursements through December 2007. These interest accruals are calculated through December 31, 2007, on the portion of annual disbursements financed by the California Water Resources Development Bond Fund, and based on the weighted average interest costs of Burns-Porter and water system revenue bonds sold to date. The reimbursements were included in DWR's budget as appropriations from the General Fund and are used by DWR to pay for operations, maintenance, power, and replacement costs associated with operating the SWP for R&FWE.

For a more detailed discussion of these legislative provisions, and DWR's procedures for reporting and tabulating recreation and enhancement costs, please see the last published Appendix D (to Bulletins 132-98, 132-99, 132-00, and 132-01). This report can be found online at <http://www.swpao.water.ca.gov/publications/index.cfm>.

**Table 13-3 Recreation and Enhancement Costs of the State Water Project**

Facility	Joint Costs Allocated to Recreation and Enhancement						
	1952–2006	2007	Subtotal	Interest	Total	132-07 Costs	Increase/ Decrease
<b>Frenchman Dam and Lake (78.5%)</b>							
California Water Resources Development Bond Fund	102,997	0	102,997	2,097	105,094	105,094	0
All Other Funds	2,719,775	0	2,719,775	0	2,719,775	2,717,730	2,045
<b>Antelope Dam and Lake (100%)</b>							
California Water Resources Development Bond Fund	1,033,261	0	1,033,261	113,788	1,147,049	1,147,049	0
All Other Funds	4,625,717	0	4,625,717	0	4,625,717	4,625,718	0
<b>Grizzly Valley Dam and Lake Davis (99.0%)</b>							
California Water Resources Development Bond Fund	4,003,092	0	4,003,092	486,754	4,489,846	4,489,846	0
All Other Funds	4,390,357	190,132	4,580,489	0	4,580,489	4,390,356	190,133
<b>Other Feather River Projects<sup>a</sup></b>							
California Water Resources Development Bond Fund	0	0	0	0	0	0	0
All Other Funds	746,131	0	746,131	0	746,131	0	746,131
<b>Delta Facilities<sup>a</sup></b>							
California Water Resources Development Bond Fund	0	0	0	0	0	0	0
All Other Funds	12,907,550	54,511	12,962,061	0	12,962,061	0	12,962,061
<b>Sisk Dam, San Luis Reservoir, O'Neill Forebay, and Los Banos Reservoir (3.4%)</b>							
California Water Resources Development Bond Fund	988,910	0	988,910	169,085	1,157,995	1,157,995	0
All Other Funds	3,504,115	891	3,505,007	0	3,505,007	3,504,390	617
<b>California Aqueduct Delta to Dos Amigos P.P. (3.4%)</b>							
California Water Resources Development Bond Fund	4,467,667	0	4,467,667	897,406	5,365,073	5,365,073	0
All Other Funds	4,660,748	24,434	4,685,183	0	4,685,183	4,662,760	22,423
<b>Oroville Division (2.9%)</b>							
California Water Resources Development Bond Fund	5,725,216	0	5,725,216	1,790,491	7,515,707	7,515,707	0
All Other Funds	5,597,267	186,500	5,783,767	0	5,783,767	5,021,397	762,370
<b>Del Valle Dam and Lake del Valle (48.0%)</b>							
California Water Resources Development Bond Fund	10,546,762	0	10,546,762	6,813,560	17,360,322	17,360,322	0
All Other Funds	4,194,521	3,648	4,198,169	0	4,198,169	4,194,879	3,290
<b>California Aqueduct Dos Amigos P.P. to Termini (5.7%)</b>							
California Water Resources Development Bond Fund	48,382,162	0	48,382,162	75,353,773	123,735,935	123,735,935	0
All Other Funds	86,457,021	784,790	87,241,811	0	87,241,811	86,478,513	763,298
<i>Subtotal</i>	<i>205,053,271</i>	<i>1,244,905</i>	<i>206,298,176</i>	<i>85,626,954</i>	<i>291,925,130</i>	<i>276,472,762</i>	<i>15,452,368</i>
<b>Specific Costs of Acquiring Land for Recreation Development</b>							
<b>Frenchman Dam and Lake</b>							
California Water Resources Development Bond Fund	3,379	0	3,379	160	3,539	3,539	0
All Other Funds	49,950	0	49,950	0	49,950	49,950	0
<b>Grizzly Valley Dam and Lake Davis</b>							
California Water Resources Development Bond Fund	204,475	0	204,475	17,573	222,048	222,048	0
All Other Funds	554,246	0	554,246	0	554,246	554,246	0
<b>Abbey Bridge Dam and Reservoir</b>							
California Water Resources Development Bond Fund	9	0	9	0	9	9	0
All Other Funds	9,921	0	9,921	0	9,921	9,921	0
<b>Antelope Dam and Lake</b>							
California Water Resources Development Bond Fund	3,167	0	3,167	0	3,167	0	3,167
All Other Funds	201,137	0	201,137	0	201,137	0	201,137
<b>Sisk Dam, San Luis Reservoir, O'Neill Forebay, and Los Banos Reservoir</b>							
California Water Resources Development Bond Fund	395,284	0	395,284	33,467	428,751	428,751	0
All Other Funds	867,243	0	867,243	0	867,243	867,243	0
<b>California Aqueduct Delta to Dos Amigos P.P.</b>							
California Water Resources Development Bond Fund	422,681	0	422,681	158,456	581,137	619,542	(38,405)
All Other Funds	(91,879)	0	(91,879)	0	(91,879)	(137,600)	45,721
<b>Oroville Division</b>							
California Water Resources Development Bond Fund	7,809,509	0	7,809,509	3,673,041	11,482,550	11,482,550	0
All Other Funds	3,408,487	246,293	3,654,780	0	3,654,780	3,921,246	(266,466)
<b>Del Valle Dam and Lake del Valle</b>							
California Water Resources Development Bond Fund	519,425	0	519,425	448,292	967,717	967,717	0
All Other Funds	(32,202)	0	(32,202)	0	(32,202)	(32,202)	0
<b>California Aqueduct Dos Amigos P.P. to Termini</b>							
California Water Resources Development Bond Fund	478,971	0	478,971	915,217	1,394,188	1,394,188	0
All Other Funds	419,088	0	419,088	0	419,088	410,296	8,792
<b>Castaic Dam and Lake</b>							
California Water Resources Development Bond Fund	1,954,297	0	1,954,297	3,856,203	5,810,500	5,810,500	0
All Other Funds	951,352	0	951,352	0	951,352	951,352	0
<b>Cedar Springs Dam and Silverwood Lake</b>							
California Water Resources Development Bond Fund	424,966	0	424,966	817,173	1,242,139	1,242,139	0
All Other Funds	370,164	0	370,164	0	370,164	370,164	0
<b>Perris Dam and Lake Perris</b>							
California Water Resources Development Bond Fund	1,022,313	0	1,022,313	2,033,799	3,056,112	3,056,112	0
All Other Funds	4,939,976	0	4,939,976	0	4,939,976	4,939,976	0
<i>Subtotal</i>	<i>24,885,959</i>	<i>246,293</i>	<i>25,132,252</i>	<i>11,953,381</i>	<i>37,085,633</i>	<i>37,131,687</i>	<i>(46,054)</i>
<b>Total Recreation and Enhancement Costs</b>							
California Water Resources Development Bond Fund	88,488,543	0	88,488,543	97,580,335	186,068,878	186,104,116	(35,238)
All Other Funds	141,450,687	1,491,198	142,941,885	0	142,941,885	127,500,333	15,441,551
<b>Total</b>	<b>229,939,230</b>	<b>1,491,198</b>	<b>231,430,428</b>	<b>97,580,335</b>	<b>329,010,763</b>	<b>313,604,449</b>	<b>15,406,313</b>

<sup>a</sup> Actual capitalized planning costs for facilities not yet constructed.

**Table 13-4 Calculation of Interest Accruals on California Water Resources Development Bond Fund Disbursements (in dollars at 4.608% per annum)**

Facility	1952-2006						2007						2008 Beginning of Year Balance to be Reimbursed					
	Disbursements			Reimbursements			Disbursements			Reimbursements			Disbursements			Reimbursements		
	WRD Bond Funds	All Other Funds	Interest Accrual	WRD Bond Funds	All Other Funds	Interest Accrual	WRD Bond Funds	All Other Funds	Interest Accrual	WRD Bond Funds	All Other Funds	Interest Accrual	WRD Bond Funds	All Other Funds	Interest Accrual	WRD Bond Funds	All Other Funds	Interest Accrual
Frenchman Dam and Lake	102,997	2,719,775	2,097	104,900	2,719,468	2,097	0	0	0	0	0	0	102,997	2,719,775	104,900	2,719,468	2,097	
Antelope Dam and Lake	1,033,261	4,625,717	1,137,888	1,140,322	4,478,932	1,137,888	0	0	0	0	0	0	1,033,261	4,625,717	1,140,322	4,478,932	1,137,888	
Grizzly Valley Dam and Lake Davis	4,003,092	4,390,357	486,754	4,444,594	2,568,667	486,754	0	190,132	0	0	0	0	4,003,092	4,580,489	4,444,594	2,568,667	486,754	
Other Feather River Projects <sup>a</sup>	0	746,131	0	0	0	0	0	0	0	0	0	0	0	0	0	0	0	0
Delta Facilities <sup>a</sup>	0	7,055,939	0	0	0	0	0	54,276	0	0	0	0	0	7,110,215	0	0	0	0
Oroville Division	5,725,216	5,597,267	1,790,491	7,324,529	4,570,269	1,790,491	0	186,500	0	0	0	0	5,725,216	5,783,767	7,324,529	4,570,269	1,790,491	
DelValle Dam and Lake del Valle	10,546,762	4,194,521	6,813,560	16,463,934	3,130,016	6,813,560	0	3,648	0	0	0	0	10,546,762	4,198,169	16,463,934	3,130,016	6,813,560	
California Aqueduct Delta to Dos Amigos P.P. and Los Banos Reservoir	4,467,667	4,660,748	897,406	5,267,351	4,092,435	897,406	0	24,434	0	0	0	0	4,467,667	4,685,183	5,267,351	4,092,435	897,406	
Sisk Dam, San Luis Reservoir, O'Neill Forebay, and Los Banos Reservoir	988,910	3,504,115	169,085	1,938,244	2,725,578	169,085	0	891	0	0	0	0	988,910	3,505,007	1,938,244	2,725,578	169,085	
California Aqueduct Dos Amigos P.P. to Termini	48,382,162	86,457,021	75,353,773	113,035,518	49,410,851	75,353,773	0	784,790	0	0	0	0	48,382,162	87,241,811	113,035,518	49,410,851	75,353,773	
<i>Subtotal</i>	<i>75,250,067</i>	<i>129,803,204</i>	<i>85,626,954</i>	<i>149,719,392</i>	<i>73,696,216</i>	<i>85,626,954</i>	<i>0</i>	<i>1,244,905</i>	<i>0</i>	<i>0</i>	<i>0</i>	<i>0</i>	<i>75,250,067</i>	<i>131,048,109</i>	<i>149,719,392</i>	<i>73,696,216</i>	<i>85,626,954</i>	
	<b>Specific Costs of Acquiring Land for Recreation Development</b>																	
Frenchman Dam and Lake	3,379	49,950	160	3,520	49,947	160	0	0	0	0	0	0	3,379	49,950	3,520	49,947	160	
Grizzly Valley Dam and Lake Davis	204,475	554,246	17,573	220,423	554,244	17,573	0	0	0	0	0	0	204,475	554,246	220,423	554,244	17,573	
Abbey Bridge Dam and Reservoir <sup>a</sup>	9	9,921	0	9	9,921	0	0	0	0	0	0	0	9	9,921	9	9,921	0	
Antelope Dam and Lake	3,167	201,137	0	0	0	0	0	0	0	0	0	0	3,167	201,137	0	0	0	
Oroville Division	7,809,509	3,408,487	3,673,041	11,028,039	649,733	3,673,041	0	246,293	0	0	0	0	7,809,509	3,654,780	11,028,039	649,733	3,673,041	
DelValle Dam and Lake del Valle	519,425	(32,202)	448,292	917,078	(32,200)	448,292	0	0	0	0	0	0	519,425	(32,202)	917,078	(32,200)	448,292	
Sisk Dam, San Luis Reservoir, O'Neill Forebay, and Los Banos Reservoir	395,284	867,243	33,467	425,700	415,610	33,467	0	0	0	0	0	0	395,284	867,243	425,700	415,610	33,467	
California Aqueduct Delta to Dos Amigos P.P.	422,681	(91,879)	1,584,556	603,887	(137,494)	1,584,556	0	0	0	0	0	0	422,681	(91,879)	603,887	(137,494)	1,584,556	
California Aqueduct Dos Amigos P.P. to Termini	478,971	419,088	915,217	1,271,912	398,349	915,217	0	0	0	0	0	0	478,971	419,088	1,271,912	398,349	915,217	
Castaic Dam and Lake	1,954,297	951,352	3,856,203	5,291,258	951,070	3,856,203	0	0	0	0	0	0	1,954,297	951,352	5,291,258	951,070	3,856,203	
Cedar Springs Dam and Silverwood Lake	424,966	370,164	817,173	1,132,207	370,137	817,173	0	0	0	0	0	0	424,966	370,164	1,132,207	370,137	817,173	
Perris Dam and Lake Perris	1,022,313	4,939,976	2,033,799	2,780,487	4,867,247	2,033,799	0	0	0	0	0	0	1,022,313	4,939,976	2,780,487	4,867,247	2,033,799	
<i>Subtotal</i>	<i>13,238,476</i>	<i>11,647,483</i>	<i>11,953,381</i>	<i>23,674,520</i>	<i>8,096,564</i>	<i>11,953,381</i>	<i>0</i>	<i>246,293</i>	<i>0</i>	<i>0</i>	<i>0</i>	<i>0</i>	<i>13,238,476</i>	<i>11,893,776</i>	<i>23,674,520</i>	<i>8,096,564</i>	<i>11,953,381</i>	
<b>Total</b>	<b>88,488,543</b>	<b>141,450,687</b>	<b>97,580,335</b>	<b>173,393,912</b>	<b>81,792,780</b>	<b>97,580,335</b>	<b>0</b>	<b>1,491,198</b>	<b>0</b>	<b>0</b>	<b>0</b>	<b>0</b>	<b>88,488,543</b>	<b>142,941,885</b>	<b>173,393,912</b>	<b>81,792,780</b>	<b>97,580,335</b>	

<sup>a</sup> Actual capitalized planning costs for facilities not yet constructed.



## Chapter 14

# Financial Analysis

*The confluence of the Sacramento (top) and American rivers in Sacramento, California.*



*Information for this chapter was provided by the State Water Project Analysis Office in conjunction with the Division of Fiscal Services.*



This chapter presents both a summary and a detailed explanation of State Water Project (SWP) current financial analysis, capital costs and requirements, revenues and expenses, and bond activities for years 2008 through 2015.

The Department of Water Resources (DWR) performs financial analysis annually to ensure that the SWP financing program will have sufficient funds to meet construction obligations; project operation, maintenance, power, and replacement costs; and debt service payments for bonds expended for construction. The results of the current financial analysis, dated December 31, 2007, are presented in Tables 14-1 and 14-2, located at the end of this chapter.

Future contingencies may change the financial analysis, some of which include:

- alterations in schedules of currently planned construction for future facilities;
- changes in economic conditions, including changes in interest rates and in SWP water contractor Table A amounts due to changes in amounts of water needed, conserved, or reclaimed;
- completion of Delta transfer facilities;
- development of additional sources of water not foreseen at this time;
- deviations from the assumptions regarding actual rates of price escalations for future construction from those currently assumed for cost estimates;
- increases in capital costs related to additional conservation facilities; and
- outcome of lawsuits now pending before the courts.

## Capital Requirements and Financing

In conducting the current analysis, DWR projected that future construction costs through the year 2015 plus reimbursement of \$314 million interim financing for prior expenditures will total \$2.07 billion. Special capital requirements for revenue bond financing of these construction costs are projected at \$227 million for a total capital requirement of \$2.30 billion. This projection includes construction and financing costs for the following significant SWP facilities planned for completion by 2015:

- South Delta facilities;
- Phase II enlargement of the East Branch of the California Aqueduct;
- Phase I improvements to the East Branch Extension;
- Phase II of the East Branch Extension;
- enlargement of the South Bay Aqueduct; and
- a new intake at Clifton Court Forebay.

Most of these capital requirements will be financed from the projected sale of \$2.26 billion of revenue bonds. The remaining \$36 million will be financed from capital resources revenues and the transfer of excess revenues not needed for operation costs or debt service.

The analysis of capital requirements and financing presented in Table 14-1 does not include the costs and financing of all facilities

needed to develop the remaining yield necessary to meet the total 4.2 million af contractual commitment to long-term SWP water contractors. Table 14-1 also does not include the costs of associated work essential for realizing full benefits from the SWP, but financed and constructed by local interests or State agencies other than DWR. Those facilities include on-shore recreational developments at SWP facilities and local distribution facilities.

The allocation of capital expenditures for various SWP purposes is detailed in Table 14-3.

## Capital Requirements

Lines 1 through 20 in Table 14-1 show actual and projected SWP capital requirements through 2015. Estimates of future capital expenditures include allowances for construction cost escalation of 5 percent per year from 2008 through 2015. Right-of-way costs are escalated at 4 percent per year from 2008 through 2015. Capital expenditures for the SWP also include requirements other than those for construction, such as disbursements made as part of the Davis-Grunsky Act Program (Line 16) and special capital requirements under revenue bond financing (Line 17). DWR will decide whether to construct facilities only after examining alternatives and completing environmental documentation and other review processes.

*Line 1, Initial Project Facilities*, includes only those facilities completed before 1974 (see Bulletin 132-74, Chapter 2). Additional costs after 1973, and estimated costs of remaining work on the initial SWP facilities, are not included.

*Line 2, North Bay Aqueduct*, consists of the estimated costs for improvements and the historical costs for Phase II. Phase II, which became operational in May 1988, connected with the Phase I facilities, which were completed in 1968 (Phase I costs

are included in the initial project facilities discussed in Line 1). Phase II included costs for pipelines, pumping plants, and a small reservoir necessary to divert water from the western Delta to Napa and Solano counties for urban use. The improvements consist of replacing the existing tank with two 5-million gallon tanks. Construction began in 2007 and is anticipated to be completed in March 2010.

*Line 3, Delta and Suisun Marsh Facilities*, shows historical costs in Column 1 that include planning for general Delta facilities and the previously planned peripheral canal and overland water delivery facilities for the western Delta. Also included are historical planning costs for Suisun Marsh as well as construction costs for the Suisun Marsh Salinity Control Gates and an access road. The projected amounts include projected planning costs plus projected costs for constructing four permanent barriers in the Delta.

*Line 4, Final Four Units at Banks Pumping Plant*, includes costs of the final four 1,067 cubic feet per second (cfs) units, which became operational in spring 1992.

*Line 5, Coastal Branch Aqueduct*, includes all costs for the planning, design, and construction of Phase II of the Coastal Branch of the California Aqueduct. Phase II construction began in October 1993 and was completed in 1997. Water deliveries from Phase II facilities began in July 1997.

*Line 6, West Branch Aqueduct*, shows costs for all facilities on the West Branch except Warne Powerplant. Those costs are included in Line 11.

*Line 7, East Branch Enlargement*, includes expenditures for Phases I and II of the East Branch Enlargement. Phase I included the enlargement share of power plant costs at Mojave Siphon and Devil Canyon. (The remaining power plant costs are included

**Table 14-3 Allocation of Capital Expenditures (Thousands of Dollars)**

Facilities and Construction Divisions	Expenditures Incurred Through 2007	Future Expenditures	Total	Preliminary Allocation Among Project Purposes			
				Water Supply and Power Generation	Flood Control <sup>a</sup>	Recreation and Fish and Wildlife Enhancement	Other <sup>b</sup>
<b>Project Construction Expenditures</b>							
Upper Feather Division	20,301	61	20,362	1,529	0	18,834	0
Oroville Division	623,257	30,297	653,554	558,773	71,783	22,998	0
Delta Facilities Division	411,948	34,095	446,043	430,925	0	15,118	0
North Bay Aqueduct	98,815	369,437	468,252	468,252	0	0	0
South Bay Aqueduct	178,344	110,731	289,075	265,644	8,195	15,236	0
California Aqueduct							
North San Joaquin Division	270,381	18,159	288,540	280,168	0	8,371	0
San Luis Division	269,719	5,528	275,247	262,727	0	12,520	0
South San Joaquin Division	310,607	9,929	320,536	302,703	0	17,833	0
Tehachapi Division	335,288	28,832	364,120	343,403	0	20,717	0
Mojave Division	292,799	37,575	330,374	290,108	0	40,266	0
Santa Ana Division	334,643	222,566	557,209	511,777	0	45,432	0
West Branch	511,259	34,074	545,333	511,569	0	33,764	0
Coastal Branch	492,800	11,838	504,638	504,638	0	0	0
<i>Subtotal, California Aqueduct</i>	<i>2,817,496</i>	<i>368,500</i>	<i>3,185,996</i>	<i>3,007,092</i>	<i>0</i>	<i>178,904</i>	<i>0</i>
Other Project Facilities							
Small Hydroelectric Power							
Generating Facilities	97,689	0	97,689	97,689	0	0	0
Off-Aqueduct Power							
Generating Facilities	474,246	43,220	517,466	517,466	0	0	0
East Branch Enlargement	453,459	399,780	853,239	853,239	0	0	0
East Branch Extension	120,645	255,024	375,669	375,669	0	0	0
Coastal Power Allocation	30,708	0	30,708	30,708	0	0	0
Agricultural Drainage Facilities	72,486	26,896	99,382	0	0	0	99,382
Planning and Preoperations	151,904	34,154	186,058	186,058	0	0	0
Unassigned/Miscellaneous	17,588	87,817	105,405	0	0	0	105,405
<i>Subtotal, Project Construction Expenditures</i>	<i>5,568,887</i>	<i>1,760,012</i>	<i>7,328,899</i>	<i>6,793,044</i>	<i>79,978</i>	<i>251,090</i>	<i>204,787</i>
<b>Other Capital Requirements</b>							
Davis-Grunsky Act Program	130,000	0	130,000	0	0	0	130,000
<b>Total Capital Expenditures</b>	<b>5,698,887</b>	<b>1,760,012</b>	<b>7,458,899</b>	<b>6,793,044</b>	<b>79,978</b>	<b>251,090</b>	<b>334,787</b>

<sup>a</sup>Reflects DWR's allocation to this purpose, irrespective of federal payments.

<sup>b</sup>Includes costs currently unassigned to purpose, planning costs of deleted features of project facilities, initial costs of inventoried items, and costs assigned to the Davis-Grunsky Act Program.

in Line 11.) East Branch Enlargement costs for Phase I, by facility, are presented in Table 14-4. Costs for Alamo Powerplant consist of expenditures for Unit 1 facilities allocated to enlargement. Construction of Unit 2 was deferred.

Work on the Environmental Impact Report (EIR), mapping, and preliminary design for Phase II of the enlargement began in March 2007. Construction is currently projected to be completed in 2017. Project costs include raising the canal embankment and concrete lining, constructing additional siphon barrels, adding bays to check structures, constructing Unit 2 at Alamo Powerplant, and adding two pump/motor units and a discharge line at Pearblossom Pumping Plant.

All costs in Line 7 are allocated to and repaid by the seven Southern California contractors participating in the East Branch Enlargement.

*Line 8, East Branch Improvements*, shows all aqueduct costs on the East Branch not allocated to the enlargement project. Those costs include improvements constructed concurrently with the enlargement work, the reconstruction of the San Bernardino Tunnel Intake, and the construction of the Tehachapi East Afterbay. Costs for power plant construction at Alamo, Mojave Siphon, and Devil Canyon are not included in this line.

*Line 9, East Branch Extension*, shows expenditures for Phases I and II of the extension of the East Branch of the California Aqueduct. The East Branch Extension extends the California Aqueduct east from the Devil Canyon Powerplant to a terminus at Noble Creek near Beaumont in Riverside County. The extension provides water service to the San Geronio Pass Water Agency and the San Bernardino Valley Municipal Water District. Construction of Phase I began in February 1999 and was completed in 2003. Phase I improvements

include enlargement of the Crafton Hills Reservoir and construction of the Yucaipa Connector Pipeline. Construction of this phase is to be completed by mid-2011. Phase II will increase the pumping capacity to 100 percent of design capacity. Construction is anticipated to begin in 2010. All costs in Line 9 will be allocated to and repaid by the two participating contractors.

*Line 10, South Bay Aqueduct Improvements and Enlargement*, shows expenditures for providing additional capacity required to meet increases in water demands for the service area of Alameda County Flood Control and Water Conservation District, Zone 7, and increasing the existing capacity of the South Bay Aqueduct to its original design capacity. Construction includes creating a third discharge line, creating a 500 af Dyer Reservoir, modifying the canal, and enlarging the South Bay Pumping Plant. Construction began in 2006 and is scheduled to be completed in 2012.

*Line 11, Power Generation and Transmission Facilities*, does not include the East Branch Enlargement share of costs for Alamo, Mojave Siphon, and Devil Canyon powerplants shown in Line 7 of Table 14-1. The capital costs for facilities included in Line 11 are shown in Table 14-5.

*Line 12, Additional Conservation Facilities*, shows projected costs to plan and study additional conservation facilities. Specific planning activities and projected spending amounts for 2008 through 2015 are shown in Table 14-6. Expenditures for these items are being reviewed. Construction costs of additional conservation facilities are not included in the financial analysis.

Line 12 does not include CALFED program costs. CALFED expenditures for preliminary planning and environmental impact report preparation are currently financed by appropriations from the General Fund. DWR assumes that future costs of the CALFED

**Table 14-4 East Branch Enlargement Capital Costs by Facility**

Facility	Amount (Millions of Dollars)
Aqueduct and Siphons	128.1
Pearblossom Pumping Plant	70.1
Alamo Powerplant	5.0
Mojave Siphon Powerplant	47.3
Devil Canyon Powerplant and Second Afterbay	202.9
<b>Total</b>	<b>453.4</b>

**Table 14-5 Estimated Capital Costs for Power Generation and Transmission Facilities**

Facility	Amount (Millions of Dollars)
<b>Power Plants</b>	
Reid Gardner, Unit 4	340.0
Bottle Rock	120.9
South Geysers	49.6
Devil Canyon	36.8
Warne	84.5
Alamo	44.9
Mojave Siphon	38.7
Thermalito Diversion Dam	14.1
<i>Subtotal</i>	<i>729.5</i>
<b>Transmission Lines</b>	
Midway–Wheeler Ridge	10.7
Geysers–Lakeville	6.9
<i>Subtotal</i>	<i>17.6</i>
<b>Total</b>	<b>747.1</b>

**Table 14-6 Estimated Future Costs for Planning Additional Conservation Facilities**

Activity	Amount (Millions of Dollars)
SWP Future Water Supply	28.3
Other Planning Costs	5.8
<b>Total</b>	<b>34.1</b>

program will continue to be financed from the General Fund.

*Line 13, Agricultural Drainage Facilities*, includes projected costs of the Agricultural Drainage Program. The activities in this program are monitoring, evaluating, reducing, and treating drainage, as well as investigating treatment and reuse of drainage water.

DWR assumes that future costs of the drainage program will be financed by revenue transfers (Line 36).

*Line 14, Other Costs*, includes items such as general design and construction costs, costs of completing operation and maintenance facilities, and costs of other completion activities for the initial facilities of the California Aqueduct. Portions of those costs ultimately will be allocated to California Aqueduct units described in the preceding paragraphs.

*Line 15, Subtotal Project Construction Expenditures*, is the total of Lines 1 through 14.

*Line 16, Davis-Grunsky Act Program Costs*, shows costs of the Davis-Grunsky Act Program, a financial assistance program to provide grants and loans to public agencies for constructing local water projects.

As of December 31, 2007, DWR had disbursed \$130 million (including \$8.5 million for administration) in grants and loans to local agencies throughout the State.

*Line 17, Special Capital Requirements Under Revenue Bond Financing*, presents special capital requirements at the time revenue bonds are sold. The financial analysis assumes that proceeds from any future revenue bonds will be used to pay for bond discounts, bond issuance costs, and debt service reserve requirements.

Information about the application of proceeds to these special requirements for actual and assumed revenue bond sales is presented in Table 14-7.

*Line 18, Total Capital Requirements*, is the total of Lines 15, 16, and 17.

*Line 19, Power Facilities Capital Requirements*, shows the total capital requirements for power facilities included in Line 18.

*Line 20, Water Facilities Capital Requirements*, shows the total capital requirements for water facilities included in Line 18.

## Capital Financing

The SWP was constructed using three general types of financing: Burns-Porter Act, revenue bonds, and capital resources. Lines 21 through 37 of Table 14-1 present specific information about these financing sources.

### Burns-Porter Act

Burns-Porter financing is derived from the sale of California Water Resources Development Bonds (general obligation bonds) and State tideland oil revenues deposited in the California Water Fund as authorized by the Burns-Porter Act (California Water Code Sections 12930–12944), approved by voters in November 1960. The Burns-Porter Act authorized an issuance of \$1.75 billion of general obligation State bonds, which are repaid by revenues received according to the water supply contracts. Of that authorization, \$130 million was reserved specifically for the Davis-Grunsky Act Program.

Proceeds from the sale of general obligation bonds were deposited in the California Water Resources Development Bond Fund—Bond Proceeds Account, from which monies were expended only for the construction of SWP facilities and for the Davis-Grunsky Act Program. Approximately 28 percent of the

**Table 14-7 Application of Revenue Bond Proceeds (Millions of Dollars)**

Bond Series <sup>a</sup>	Construction Expenditures	Other Capital Requirements				Subtotal	Total Principal Amount of Bonds
		Reimbursement of General Fund	Capitalized Interest	Capitalized Operating Costs	Bond Financing and Refunding Costs <sup>b</sup>		
Oroville	218.0	2.6	19.9	1.5	3.0	27.0	245.0
Devil Canyon-Castaic	126.4	0.0	10.0	0.7	2.1	12.8	139.2
Pyramid Series A	74.0	0.0	19.2	1.0	1.6	21.8	95.8
Reid Gardner Series B	146.1	0.0	41.9	0.0	12.0	53.9	200.0
Reid Gardner Series C	91.1	0.0	17.9	7.9	8.1	33.9	125.0
Small Hydro-South Geysers Series D	49.6	0.0	19.9	0.0	5.5	25.4	75.0
Bottle Rock Series E	96.9	0.0	22.0	3.7	2.4	28.1	125.0
Alamo-South Geysers Series F	59.1	0.0	14.2	0.0	1.7	15.9	75.0
Reid Gardner Series G	1.6	0.0	0.0	0.0	237.9	237.9	239.5
Power Facilities Series H	22.2	0.0	0.0	0.0	184.5	184.5	206.7
East Branch Enlargement Series A	108.3	0.0	12.6	0.0	11.1	23.7	132.0
Water System Facilities Series B	97.4	0.0	0.0	0.0	2.6	2.6	100.0
Water System Facilities Series C	0.6	0.0	0.0	0.0	8.4	8.4	9.0
Water System Facilities Series D	95.9	0.0	2.9	0.0	1.2	4.1	100.0
Water System Facilities Series E	0.4	0.0	0.0	0.0	8.6	8.6	9.0
Water System Facilities Series F	0.0	0.0	0.0	0.0	160.0	160.0	160.0
Water System Facilities Series G	86.8	0.0	4.6	0.0	8.6	13.2	100.0
Water System Facilities Series H	85.5	0.0	5.7	0.0	8.8	14.5	100.0
Water System Facilities Series I	158.9	0.0	5.8	0.0	15.3	21.1	180.0
Water System Facilities Series J	0.0	0.0	0.0	0.0	649.8	649.8	649.8
Water System Facilities Series K	88.6	0.0	3.1	0.0	8.3	11.4	100.0
Water System Facilities Series L	0.0	0.0	0.0	0.0	537.8	537.8	537.8
Water System Facilities Series M	166.3	0.0	9.9	0.0	13.8	23.7	190.0
Water System Facilities Series N	137.4	0.0	6.0	0.0	8.6	14.6	152.0
Water System Facilities Series O	156.5	0.0	8.4	0.0	170.1	178.5	335.0
Water System Facilities Series P	141.6	0.0	5.2	0.0	13.2	18.4	160.0
Water System Facilities Series Q	135.0	0.0	8.0	0.0	123.6	131.6	266.6
Water System Facilities Series R	0.0	0.0	0.0	0.0	20.7	20.7	20.7
Water System Facilities Series S	78.2	0.0	5.8	0.0	116.2	122.0	200.2
Water System Facilities Series T	0.0	0.0	0.0	0.0	135.7	135.7	135.7
Water System Facilities Series U	98.7	0.0	5.3	0.0	103.2	108.5	207.2
Water System Facilities Series V	0.0	0.0	0.0	0.0	20.6	20.6	20.6
Water System Facilities Series W	41.0	0.0	1.3	0.0	218.7	220.0	261.0
Water System Facilities Series X	0.0	0.0	0.0	0.0	160.2	160.2	160.2
Water System Facilities Series Y	0.0	0.0	0.0	0.0	329.9	329.9	329.9
Water System Facilities Series Z	0.0	0.0	0.0	0.0	170.7	170.7	170.7
Water System Facilities Series AA	0.0	0.0	0.0	0.0	108.7	108.7	108.7
Water System Facilities Series AB	92.2	0.0	3.9	0.0	93.6	97.5	189.7
Water System Facilities Series AC	13.7	0.0	0.6	0.0	257.7	258.3	272.0
Water System Facilities Series AD	12.4	0.0	0.9	0.0	99.1	100.0	112.4
<i>Subtotal</i>	<i>2,680.4</i>	<i>2.6</i>	<i>255.0</i>	<i>14.8</i>	<i>4,043.6</i>	<i>4,316.0</i>	<i>6,996.4<sup>c</sup></i>
Future East Branch Enlargement Bonds	399.8	0.0	19.7	0.0	25.1	44.8	444.6
Future East Branch Extension Bonds	249.2	0.0	12.2	0.0	15.5	27.7	276.9
Future So. Bay Aq. Enlargement Bonds	166.7	0.0	8.1	0.0	10.4	18.5	185.2
Future Water System Facilities Bonds	1,222.4	0.0	59.7	0.0	76.0	135.7	1,358.1
<b>Total</b>	<b>4,718.5</b>	<b>2.6</b>	<b>354.7</b>	<b>14.8</b>	<b>4,170.6</b>	<b>4,542.7</b>	<b>9,261.2</b>

<sup>a</sup> Actual bond issue for all except future East Branch Enlargement, future East Branch Extension, future South Bay Aqueduct Improvements and Enlargement, and future Water System Facilities bonds.

<sup>b</sup> Bond financing and refunding costs include funds applied to debt service reserve requirements.

<sup>c</sup> Includes \$3,581.9 million of refunded principal, leaving a net principal obligation of \$3,414.5 million.

expenditures through 2007 for construction and the Davis-Grunsky Act Program were financed with general obligation bonds.

Monies deposited in the California Water Fund were appropriated for purposes outlined in the Burns-Porter Act. Such deposits were derived from a portion of the State tideland oil revenues, in accordance with a continuing authorization. The California Water Fund was used to finance \$508 million, or approximately 8 percent, of the construction expenditures through 2007.

### Revenue Bonds

Revenue bond financing is derived from the sale of revenue bonds as authorized by the Central Valley Project Act (California Water Code Sections 11100–11925). DWR's authority to issue revenue bonds was confirmed by a decision of the California Supreme Court in 1963 (*Warne v. Harkness*, 60 Cal. 2d 579).

Proceeds from the sale of revenue bonds are deposited in the Central Valley Water Project Construction Fund, from which money is expended only for purposes specified in the resolution authorizing each bond sale. Those purposes, in addition to paying construction, planning, and right-of-way costs, may include funding the Debt Service Reserve Account, paying interest on bonds, and paying water system operating expenses during a specified period.

As of December 31, 2007, DWR had sold \$7.0 billion of revenue bonds. That amount includes \$3.6 billion of refunded bonds, leaving a total principal obligation of \$3.4 billion.

### Capital Resources

Capital resources financing is derived from payments and appropriations (including a portion of the State tideland oil revenues) authorized by a variety of special contracts, cost-sharing agreements, and legislative

actions concerning the SWP, plus accrued interest on these funds. Capital resources revenues are deposited in the Central Valley Water Project Construction Fund and may be expended for interest on general obligation bonds and costs of constructing SWP facilities.

According to DWR's financial management policy, the capital resources revenues are used first to cover any general obligation bond debt service that exceeds available revenues.

### Capital Financing Sources

Capital financing sources include power revenue bonds, East Branch Enlargement bonds, East Branch Extension bonds, South Bay Aqueduct Enlargement bonds, water system facilities bonds, initial project facilities bonds, bond proceeds from the Davis-Grunsky Act Program, California Water Fund monies, and capital resources revenues.

*Line 21, Power Revenue Bonds through Series H*, includes the proceeds applied from power revenue bonds for Oroville, Devil Canyon, Castaic, Warne, Reid Gardner, Bottle Rock, Alamo, South Geysers, and small hydro projects.

No future power revenue bond sales are projected for this financial analysis.

*Line 22, East Branch Enlargement, Current Bonds*, shows that \$474 million of Water System Revenue Bond proceeds has been applied to the East Branch Enlargement project through December 31, 2007. Of this total amount, \$417 million was used for construction expenditures and \$57 million for bond discounts, interest costs, and debt service reserves.

*Line 23, East Branch Enlargement, Future Bonds*, shows DWR's estimate of \$445 million of bonds required to



complete construction of the East Branch Enlargement Phase II.

*Line 24, East Branch Extension, Current Bonds*, shows that \$140 million of Water System Revenue Bond proceeds had been spent through December 31, 2007.

*Line 25, East Branch Extension, Future Bonds*, shows DWR's estimate of \$277 million of additional bonds required to complete construction of the East Branch Extension and to pay for bond discounts, capitalized interest, and debt service reserve requirements.

*Line 26, South Bay Aqueduct Enlargement, Current Bonds*, shows that \$17 million of Water System Revenue Bond proceeds had been spent through December 31, 2007.

*Line 27, South Bay Aqueduct Enlargement, Future Bonds*, shows DWR's estimate of \$185 million of bonds required to complete construction of the South Bay Aqueduct Enlargement and to pay for bond discounts, capitalized interest, and debt service reserve requirements.

*Line 28, Water System Facilities, Current Bonds*, shows that through December 31, 2007, \$1.5 billion of proceeds from Water System Revenue Bonds, Series A through Series AD, was applied to SWP projects other than the East Branch Enlargement, the East Branch Extension, and the South Bay Aqueduct Enlargement. Of this total, \$1.3 billion was used to pay for construction expenditures and \$0.2 billion was used to pay for bond discounts, capitalized interest, and debt service reserve requirements.

*Line 29, Water System Facilities, Future Bonds*, shows that \$1.4 billion of future water revenue bonds is needed to provide \$1.2 billion for construction of SWP water system facilities and \$0.2 billion for bond discounts, interest costs, and debt service reserve requirements.

*Line 30, Subtotal, Water Revenue Bonds*, is the total of Lines 22 through 29.

*Line 31, Initial Project Facilities Bond Proceeds*, shows the amount of general obligation bonds sold to provide financing costs for initial SWP facilities and for costs of planning certain additional conservation facilities.

Financing initial facilities from general obligation bonds was completed in mid-1972 and totaled \$1.444 billion—\$1.750 billion Burns-Porter Act authorization less \$130 million reserved for the Davis-Grunsky Act Program and \$176 million “offset” for additional conservation facilities. (The Burns-Porter Act provides that to the extent California Water Fund monies are expended, an equal amount of general obligation bonds are reserved [offset] for financing the construction of additional conservation facilities in certain watersheds.)

In mid-1972, the reservation of offset bonds was effectively limited to \$176 million, the total amount of California Water Fund monies expended up to that time. By mid-1972, all general obligation bonds authorized by the Burns-Porter Act had been offset, reserved for the Davis-Grunsky Act Program, or used for SWP construction.

Approximately \$8.5 million of the offset bonds was used to finance planning studies of the Middle Fork Eel River Development. This financial analysis is not based on the use of any offset bond proceeds to meet capital requirements. If, at some time, the State constructs an additional conservation facility, as specified in Water Code Section 12938, the remaining offset bonds could be sold.

*Line 32, Davis-Grunsky Act Program Bond Proceeds*, shows, for simplification, the entire \$130 million of capital expenditures authorized for the Davis-Grunsky Act Program, according to the Burns-Porter Act, as being funded by proceeds from the sale of

general obligation bonds. In fact, \$28 million from the California Water Fund was used for the program in lieu of bond proceeds prior to 1969.

*Line 33, Application of California Water Fund Monies*, shows the amount of SWP costs financed under the Burns-Porter Act. The act provides that any available money in the California Water Fund must be used for construction in lieu of proceeds from the sale of general obligation bonds.

When the Burns-Porter Act became effective in late 1960, approximately \$97 million had been accumulated in the fund. That balance, plus subsequent appropriations, interest earnings, and other miscellaneous income to the fund through December 31, 2007, was used to finance a total of \$508 million of SWP costs.

*Line 34, Interim Financing*, shows the net annual amounts of funds flowing into and out of the Water Revenue Commercial Paper Notes program. This program was established in March 1993 to provide an ongoing source of interim financing for water system projects prior to permanent financing from the sale of long-term revenue bonds. DWR has authority to issue up to \$94.4 million of Water Revenue Commercial Paper Notes. A positive number indicates money borrowed from the program to finance construction costs. A negative number indicates money repaid to the program. The financial analysis assumes that all funds borrowed from the program will be repaid before the end of the analysis period.

*Line 35, Application of Capital Resources Revenues to Construction*, presents the Capital Resources Revenues applied for capital expenditures.

*Line 36, Revenue Transfers Applied*, shows monies assumed to be transferred to the California Water Fund, according to provisions of the Burns-Porter Act, and

subsequently reappropriated to construction (see Line 40 of Table 14-2). Projected amounts for 2008 through 2015 include funds to finance expenditures for agricultural drainage facilities, as indicated in Line 13 of Table 14-1, and expenditures for additional conservation facilities, as indicated in Line 12.

*Line 37, Subtotal, Other Capital Financing*, is the total of Lines 31 through 36.

*Line 38, Total Financing of Capital Requirements*, totals Lines 21, 30, and 37.

## Annual Revenues and Expenditures

After financial analysis of SWP operations, DWR concluded that projected payments by contractors and other revenues will be adequate to pay annual operations, maintenance, power, and replacement costs and meet all repayment obligations on funds used to finance SWP construction and other authorized costs during the period 2008 through 2015. Data on annual revenues and expenditures are presented in Table 14-2. A detailed discussion of each line item follows.

### Project Revenues

Project revenues consist primarily of SWP contractor payments required under their individual long-term water supply contracts. Those revenues are deposited in two funds: the Central Valley Water Project Revenue Fund, where all revenues pledged to revenue bonds are placed, and the California Water Resources Development Bond Fund-Systems Revenue Account, where all other SWP operating revenues are placed. Use of those funds is limited to paying operating costs and debt service; except that revenues in excess of those costs may be deposited to a reserve for future SWP construction, since the California Water Fund has been repaid (see Line 39).

*Line 1, Capital Resources Revenues*, includes the following:

- federal payments for SWP capital expenditures;
- appropriations for capital costs allocated to recreation;
- appropriations for SWP capital expenditures prior to passage of the Burns-Porter Act and according to Senate Bill 261 (1968);
- payments from Los Angeles Department of Water and Power (LADWP) for Castaic power development;
- advances from contractors for construction of requested work;
- investment earnings on the Capital Resources Account; and
- investment earnings on unexpended revenue bond proceeds.

Historically, appropriations for capital costs allocated to recreation and fish and wildlife enhancement have amounted to \$5 million per year and have been appropriated by the California Legislature from the State tideland oil revenues. There have been no appropriations since 1985, and no appropriations are indicated in the financial analysis for the period 2008–2015. Legislation enacted in 1989 offset a portion of the amount owed to the SWP by the State for costs allocated to recreation and fish and wildlife enhancement against the amount the SWP owed to the California Water Fund (see Line 39).

*Lines 2 through 12, Water Contractor Payments*, show amounts of the separate elements of water contractor payments.

Amounts in Line 4 also include revenues sufficient to cover costs associated with sales of excess power. Appendix B of this bulletin presents a detailed explanation of payments identified in Lines 2 through 12.

Operations, maintenance, power, and replacement (OMP&R) costs are repaid as they are incurred as part of the Transportation Charge; therefore, no interest charges are included. Construction costs included in the Transportation Charge, and all construction and annual OMP&R costs included in the Delta Water Charge, are to be repaid with interest at the Project Interest Rate.

The Project Interest Rate, as defined in Article 1(r) of the standard provisions for water supply contracts, is the weighted average of the rates paid on certain securities issued and loans obtained to finance SWP facilities.

According to the original contract provisions, the basis for determining the Project Interest Rate was the weighted average of rates paid on general obligation bond sales only. In 1969, after Oroville Revenue Bonds were issued, the contracts were amended to expand the basis to include rates on all other securities sold and loans obtained thereafter for financing SWP facilities, including revenue bonds (see Bulletin 132-70, page 28).

However, not all proceeds from the sale of revenue bonds are melded into the calculation of the Project Interest Rate. Only those proceeds applied to construction costs (the only application of general obligation bonds permitted by law) and those consumed by the bond discount (a component of the total interest cost of a revenue bond issue) are included in the calculation (see Table 14-8).

Calculations for determining the Project Interest Rate do not include proceeds from the sale of revenue bonds for Off-Aqueduct Power facilities, the East Branch Enlargement facilities, South Bay Aqueduct, or water system facilities defined in the Water Revenue Bond Amendment.

Table 14-9 lists all bond sales by date and presents basic information used in the calculation of the Project Interest Rate.

Information about contractor water charges in Appendix B is based on known conditions and substantiates DWR's determination of 2009 water charges to be billed on July 1, 2008. However, information about significant differences between the sum of future charges included in Lines 2 through 12 of Table 14-2 and the substantiation of 2009 charges included in Appendix B are as follows.

- Future capital costs in Appendix B are based on the prevailing prices as of December 31, 2007. Those costs presented in the financial analysis include allowances for price escalation.
- Pre-2008 charges in Appendix B represent charges as they should have been, according to currently known conditions. Pre-2008 charges included in Table 14-2 are those actually paid as part of previously determined bills.
- Charges in Appendix B are unadjusted for past overpayments or underpayments. Charges included in Table 14-2 for 2008 and thereafter have been adjusted for any apparent overpayments or underpayments of pre-2008 charges.
- Charges in Appendix B for East Branch Enlargement costs include the amounts for debt service and 25 percent cover for the East Branch Enlargement share of the Series A through Series AD bonds. Charges in Table 14-2 apply to Series A through Series AD bonds and also include amounts of the debt service and cover for assumed future bonds.
- The water revenue bond surcharge in Appendix B applies only to the Series B through Series AD bonds. Surcharge values included in Table 14-2 apply to Series B through Series AD bonds and to assumed future issues required to finance SWP construction costs included in Table 14-1.

*Line 13, Subtotal, Water Contractor Payments,* is the total of Lines 2 through 12.

*Line 14, Revenue Bond Cover Adjustments,* represents the credit to contractors resulting from the cover of 25 percent of one year's debt service for Off-Aqueduct Power Facility Bonds and Water System Revenue Bonds. Cover is collected as required by the bond resolutions to provide security to the bondholders. If not needed to meet annual bond service, the cover is credited to the contractors in the following year. The annual charges for the following cost components include an amount for bond cover:

- minimum OMP&R component of the Transportation Charge for Off-Aqueduct Power Facilities;
- Water System Revenue Bond Surcharge;
- capital cost component of the Transportation Charge for East Branch Enlargement Facilities;
- capital cost component of the Transportation Charge for Coastal Branch Extension Facilities;
- capital cost component of the Transportation Charge for East Branch Extension Facilities;
- capital cost component of the Transportation Charge for Tehachapi Afterbay; and
- capital cost component of the Transportation Charge for South Bay Aqueduct Enlargement.

*Line 15, Rate Management Adjustments,* shows the projected amount of revenue reductions allocated to contractors after repayment of the California Water Fund (see Line 39). Under provisions of the Monterey Amendment, the reduction amount allocated to agricultural contractors is deposited into a trust fund to stabilize payments in water-short years. The urban contractor allocation is applied as a direct reduction in charges.

**Table 14-8 Revenue Bond Proceeds Affecting Project Interest Rate (Millions of Dollars)**

Project	Proceeds Included in Project Interest Rate				Total Principal Amount of Bonds	Percentage of Total Amount Included in Calculating Project Interest Rate [4] / [5]
	Applied to Construction Costs	Less Portion of Proceeds Derived from Interest Earnings Prior to Delivery of Bonds	Plus Bond Financing and Refunding Costs	Subtotal, Proceeds Included in Calculating Project Interest Rate [1] - [2] + [3]		
	[1]	[2]	[3]	[4]		
Devil Canyon-Castaic Project Revenue Bonds	125.3	1.5	1.4	125.2	139.2	90
Pyramid Project Revenue Bonds (Series A)	71.2	0.5	1.1	71.8	95.8	75
Alamo Project Bond Anticipation Note	16.8	0.1	0.3	17.0	24.4	70
Small Hydro Project I Revenue Bonds (Series D)	25.4	0.2	1.5	26.7	37.5	71
Alamo Project Revenue Bonds (Series F)	38.9	0.3	0.7	39.3	50.0	79
Power Facilities Revenue Bonds (Series H)						
Pyramid Project	5.0	0.0	0.1	5.1	5.1	100
Alamo Project	1.7	0.0	0.0	1.7	1.7	100
Small Hydro Project I	25.2 <sup>a</sup>	0.2	0.4	25.4	35.6	71
Water System Revenue Bonds (Series J)						
Pyramid Project	0.0	0.0	75.9 <sup>b</sup>	75.9	99.2 <sup>b</sup>	77
Alamo Project	0.0	0.0	45.6 <sup>b</sup>	45.6	57.1 <sup>b</sup>	80
Small Hydro Project I	0.0	0.0	27.8 <sup>b</sup>	27.8	38.8 <sup>b</sup>	72
Water System Revenue Bonds (Series L)						
Small Hydro Project I	0.0	0.0	1.5 <sup>b</sup>	1.5	2.1 <sup>b</sup>	71
Water System Revenue Bonds (Series Q)						
Pyramid Project	0.0	0.0	3.0 <sup>b</sup>	3.0	3.9 <sup>b</sup>	77
Alamo Project	0.0	0.0	4.8 <sup>b</sup>	4.8	6.0 <sup>b</sup>	80
Water System Revenue Bonds (Series S)						
Pyramid Project	0.0	0.0	8.0 <sup>b</sup>	8.0	10.4 <sup>b</sup>	77
Alamo Project	0.0	0.0	7.6 <sup>b</sup>	7.6	9.5 <sup>b</sup>	80
Water System Revenue Bonds (Series U)						
Pyramid Project	0.0	0.0	2.4 <sup>b</sup>	2.4	3.2 <sup>b</sup>	75
Alamo Project	0.0	0.0	3.2 <sup>b</sup>	3.2	4.0 <sup>b</sup>	80
Water System Revenue Bonds (Series W)						
Pyramid Project	0.0	0.0	27.7 <sup>b</sup>	27.7	36.0 <sup>b</sup>	77
Alamo Project	0.0	0.0	11.8 <sup>b</sup>	11.8	14.7 <sup>b</sup>	80
Small Hydro Project (construction)	3.4	0.0	0.0	3.4	3.7	92
Small Hydro Project (refunding)	0.0	0.0	16.3 <sup>b</sup>	16.3	22.7 <sup>b</sup>	72
Water System Revenue Bonds (Series X)						
Pyramid Project	0.0	0.0	8.5 <sup>b</sup>	8.5	11.0 <sup>b</sup>	77
Alamo Project (Series H refunding)	0.0	0.0	0.3 <sup>b</sup>	0.3	0.3 <sup>b</sup>	100
Alamo Project (Series F refunding)	0.0	0.0	3.9 <sup>b</sup>	3.9	4.9 <sup>b</sup>	79
Small Hydro Project	0.0	0.0	4.6 <sup>b</sup>	4.6	6.4 <sup>b</sup>	72
Water System Revenue Bonds (Series AC)						
Pyramid Project	0.0	0.0	3.8 <sup>b</sup>	3.8	5.0 <sup>b</sup>	76
Alamo Project	0.0	0.0	2.8 <sup>b</sup>	2.8	3.6 <sup>b</sup>	80
Small Hydro Project	0.0	0.0	1.2 <sup>b</sup>	1.2	1.6 <sup>b</sup>	72
Water System Revenue Bonds (Series AD)						
Pyramid Project	0.0	0.0	3.2 <sup>b</sup>	3.2	4.2 <sup>b</sup>	76
Alamo Project	0.0	0.0	2.6 <sup>b</sup>	2.6	3.3 <sup>b</sup>	80
Small Hydro Project	0.0	0.0	0.7 <sup>b</sup>	0.7	1.0 <sup>b</sup>	72

<sup>a</sup> Amount consists of 71 percent of proceeds deposited in escrow to refund portion of Series D bonds (\$35.1 million plus deposits to construction account [\$0.3 million]).

<sup>b</sup> Represents amount of principal used to refund portions of prior bond issues.

**Table 14-9 Actual Bond Sales and Project Interest Rates, by Date of Sale**

Bond Sales	Date of Sale	Dollar-Years <sup>a</sup> (Thousands)	Interest Cost (Thousands)	Issue Interest Rate <sup>b</sup> (Percent)	Project Interest Rate <sup>c</sup> (Percent)
\$ 50,000,000 Bond Anticipation Notes	11/21/63	26,944	531	1.971	1.971
\$100,000,000 Series A Water Bonds	2/18/64	3,402,000	119,750	3.520	3.508
\$ 50,000,000 Series B Water Bonds	5/05/64	1,726,000	60,986	3.533	3.516
\$100,000,000 Series C Water Bonds	10/07/64	3,452,000	123,764	3.585	3.544
\$100,000,000 Series D Water Bonds	2/16/65	3,497,900	122,403	3.499	3.531
\$100,000,000 Series E Water Bonds	11/23/65	3,497,900	130,029	3.717	3.573
\$100,000,000 Series F Water Bonds	6/08/66	3,497,900	137,359	3.927	3.638
\$100,000,000 Series G Water Bonds	11/22/66	3,497,900	143,788	4.111	3.711
\$100,000,000 Series H Water Bonds	3/21/67	3,497,900	129,261	3.695	3.709
\$100,000,000 Series J Water Bonds	7/18/67	3,497,900	143,199	4.094	3.754
\$100,000,000 Series K Water Bonds	11/14/67	3,497,900	163,887	4.685	3.853
\$150,000,000 Revenue Bonds, Oroville Division, Series A	4/03/68	5,228,700	270,289	5.169	
\$100,000,000 Series L Water Bonds	7/11/68	3,497,900	166,918	4.772	3.941
\$100,000,000 Series M Water Bonds	10/22/68	3,497,900	169,989	4.860	4.021
\$ 94,995,000 Revenue Bonds, Oroville Division, Series B	4/01/69	3,423,460	195,902	5.722	
\$ 46,761,000 Cumulative 1970 General Fund Borrowing, repaid 7/10/70	—	4,938	346	7.007	
\$200,000,000 Series N and P Bond Anticipation Notes	6/16/70	200,000	11,660	5.830	4.030
\$100,000,000 Series N Water Bonds	2/02/71	3,447,900	190,292	5.519	4.148
\$100,000,000 Series Q Bond Anticipation Notes	3/10/71	100,000	2,349	2.349	4.143
\$100,000,000 Series P Water Bonds	4/21/71	3,397,900	193,377	5.691	4.255
\$150,000,000 Series Q and R Water Bonds	11/09/71	5,171,850	265,734	5.138	4.342
\$ 40,000,000 Series S Water Bonds	3/28/72	1,399,160	76,509	5.468	4.371
\$139,165,000 Devil Canyon-Castaic Revenue Bonds	8/08/72	4,776,204	258,839	5.419	4.457
\$ 10,000,000 Series T Water Bonds	3/20/73	185,265	9,491	5.123	4.459
\$ 10,000,000 Series U Water Bonds	1/13/76	158,750	8,731	5.500	4.462
\$ 10,000,000 Series V Water Bonds	11/15/77	158,750	7,573	4.770	4.462
\$ 95,800,000 Pyramid Hydroelectric Revenue Bonds	10/23/79	2,260,072	172,495	7.632	4.584
\$150,000,000 Reid Gardner Project, Series A Bond Anticipation Notes	7/1/81	347,906	29,572	8.500	
\$ 75,600,000 Bottle Rock Project, Bond Anticipation Notes	12/1/81	264,600	25,137	9.500	
\$ 24,400,000 Alamo Project, Bond Anticipation Notes	12/1/81	24,266	2,305	9.499	4.589
\$200,000,000 Reid Gardner Project, Series B Revenue Bonds	7/07/82	4,623,137	553,793	11.979	
\$125,000,000 Reid Gardner Project, Series C Revenue Bonds	11/16/82	2,720,045	255,744	9.402	
\$ 37,500,000 Small Hydro Project I, Series D Revenue Bonds	11/16/82	837,769	84,587	10.097	4.666
\$ 37,500,000 South Geysers Project, Series D Revenue Bonds	11/16/82	930,325	90,021	9.676	
\$125,000,000 Bottle Rock Project, Series E Revenue Bonds	4/27/83	2,624,805	225,102	8.576	
\$ 50,000,000 Alamo Project, Series F Revenue Bonds	4/27/83	1,190,763	100,836	8.468	4.727
\$ 25,000,000 South Geysers Project, Series F Revenue Bonds	4/27/83	608,550	52,578	8.640	

**Table 14-9 Actual Bond Sales and Project Interest Rates, by Date of Sale**

Bond Sales	Date of Sale	Dollar-Years <sup>a</sup> (Thousands)	Interest Cost (Thousands)	Issue Interest Rate <sup>b</sup> (Percent)	Project Interest Rate <sup>c</sup> (Percent)
\$239,505,000 Reid Gardner Project, Series G Revenue Bonds	3/15/85	4,524,136	425,840	9.413	
\$206,690,000 Power Facilities Series H Revenue Bonds	6/20/86	4,430,520	347,745	7.849	4.713
\$132,000,000 East Branch Enlargement, Series A Water System Revenue Bonds	7/15/86	3,427,165	254,915	7.438	
\$100,000,000 Series B Water System Revenue Bonds	5/05/87	2,564,012	194,817	7.598	
\$ 9,000,000 Series C Water System Revenue Bonds	12/01/87	324,000	31,995	9.875	
\$100,000,000 Series D Water System Revenue Bonds	6/14/88	2,640,510	201,253	7.622	
\$ 9,000,000 Series E Water System Revenue Bonds	11/29/88	324,000	31,995	9.875	
\$160,030,000 Series F Water System Revenue Bonds	3/15/89	2,779,838	189,261	6.808	
\$100,000,000 Series G Water System Revenue Bonds	3/06/90	2,434,175	172,277	7.077	
\$100,000,000 Series H Water System Revenue Bonds	1/10/91	2,459,172	168,857	6.866	
\$180,000,000 Series I Water System Revenue Bonds	5/14/91	4,366,680	294,090	6.735	
\$649,835,000 Series J Water System Revenue Bonds	1/16/92	12,422,222	745,198	5.999	
\$100,000,000 Series K Water System Revenue Bonds	5/12/92	2,366,783	147,064	6.214	
\$ 9,000,000 Series W Water Bonds	8/19/92	95,250	6,172	6.480	4.621
\$537,830,000 Series L Water System Revenue Bonds	5/19/93	11,414,859	640,518	5.611	4.620
\$ 2,000,000 Series X Water Bonds	9/01/93	26,000	1,247	4.796	4.621
\$ 1,400,000 Series Y Water Bonds	11/30/94	19,483	1,249	6.411	
\$190,000,000 Series M Water System Revenue Bonds	12/19/93	3,911,846	194,981	4.984	
\$152,000,000 Series N Water System Revenue Bonds	3/03/95	2,241,606	122,658	5.472	
\$335,000,000 Series O Water System Revenue Bonds	12/05/95	7,528,890	375,667	4.990	
\$160,000,000 Series P Water System Revenue Bonds	5/07/96	3,553,823	204,524	5.755	
\$266,630,000 Series Q Water System Revenue Bonds	11/05/96	5,481,815	299,846	5.470	4.620
\$20,700,000 Series R Water System Revenue Bonds	3/10/97	564,125	36,627	6.493	
\$200,205,000 Series S Water System Revenue Bonds	8/04/97	4,093,110	203,755	4.978	4.615
\$135,665,000 Series T Water System Revenue Bonds	8/04/97	1,310,620	66,942	5.108	
\$207,180,000 Series U Water System Revenue Bonds	12/01/98	4,032,075	200,758	4.979	
\$ 20,580,000 Series V Water System Revenue Bonds	12/01/98	525,100	32,819	6.250	
\$260,995,000 Series W Water System Revenue Bonds	5/01/01	3,659,312	195,822	5.351	4.613
\$160,225,000 Series X Water System Revenue Bonds	5/01/02	2,732,785	139,109	5.090	4.610
\$329,885,000 Series Y Water System Revenue Bonds	7/05/02	4,422,973	222,654	5.034	
\$170,655,000 Series Z Water System Revenue Bonds	10/02/02	1,706,132	75,696	4.437	
\$108,705,000 Series AA Water System Revenue Bonds	10/04/02	2,114,341	104,220	4.929	
\$189,625,000 Series AB Water System Revenue Bonds	3/09/04	4,344,942	173,788	4.000	
\$272,070,000 Series AC Water System Revenue Bonds	12/15/04	4,479,436	209,150	4.669	
\$112,390,000 Series AD Water System Revenue Bonds	6/14/05	1,827,449	90,461	4.950	4.608
<b>Total</b>		<b>199,322,344</b>	<b>11,499,096</b>		
<b>Portion allocated to Project Interest Rate</b>		<b>63,912,154</b>	<b>2,945,036</b>	<b>4.608</b>	<b>4.608</b>

<sup>a</sup> A unit equivalent to one dollar of principal amount outstanding for one year.

<sup>b</sup> The total interest cost (without regard to discounts paid or to premiums received) divided by the total dollar-years, expressed as a percent.

<sup>c</sup> Determined by dividing cumulative interest costs by cumulative dollar-years, expressed as a percent. (Oroville Division bonds and revenue bonds for Off-Aqueduct Power Facilities, the East Branch Enlargement Facilities, East Branch Extension Facilities, Water System Facilities as defined in the Water Revenue Bond Amendment, Coastal Extension Facilities, and South Bay Enlargement Facilities are excluded from this calculation.)

*Line 16, Federal Payments for Project Operating Costs*, shows federal payments made in accordance with the December 31, 1961, agreement between California and the United States providing for DWR to operate and maintain the San Luis Joint-Use Facilities. According to the January 12, 1972, supplement to the agreement, the Bureau of Reclamation (Reclamation) initially paid 45 percent of operations, maintenance, and replacement (OM&R) costs for those activities. (The percentage does not apply to power costs; Reclamation and DWR each provide their own power to pump water through the joint facilities.)

The percentage paid by Reclamation is periodically reviewed by Reclamation and DWR. The most recent review of the percentage paid by Reclamation was completed in 1987 and resulted in a federal share of 44.09 percent. The amounts in Line 16 are based on the assumption that the federal share will continue at this level for calendar years 2008 through 2015.

*Line 17, Appropriations for Operating Costs Allocated to Recreation*, shows appropriations made under the Davis-Dolwig Act (DDA). In passing the DDA, the California Legislature declared its intent that except for funds provided according to Assembly Bill 12 (1966), DWR's budget will include appropriations of monies from the General Fund necessary for enhancement of fish and wildlife and recreation in connection with State water projects.

Annual OMP&R costs allocated to recreation and fish and wildlife enhancement are to be paid by annual appropriations from the General Fund. Through fiscal year 1982–1983, these appropriations totaled \$16.657 million. There have been no additional appropriations since the 1982–1983 fiscal year and none are indicated for 2008 through 2015.

Legislation enacted in 1989 offset a portion of the amount owed to the SWP by the State for costs allocated to recreation and to fish and wildlife enhancement against the amount the SWP owed to the California Water Fund (see line 39).

*Line 18, Davis-Grunsky Loan Repayments*, shows the repayments by local agencies of \$54.2 million of loans disbursed as of December 31, 2007. Repayment on any future loans was assumed to be beyond the period covered by the financial analysis.

*Line 19, Revenue Bond Proceeds*, includes bond proceeds classified as special reserves according to the description of revenue bond financing in Line 17 of Table 14-1. Those proceeds, used for capitalized OMP&R costs, revenue bond debt service, and debt service reserves, are not classified as revenue but are included in this line to simplify the financial presentation.

*Line 20, Interest Earnings on Operating Revenues*, includes interest earnings on unexpended proceeds from the sale of general obligation bonds, interest on operating reserves, and other short-term investment earnings on SWP revenues.

*Line 21, Oroville-Thermalito Payments*, shows payments from Pacific Gas and Electric Company (PG&E), Southern California Edison (SCE), and San Diego Gas & Electric Company (SDG&E) for power generation at the Oroville facilities. Those utilities purchased all power generation from Hyatt and Thermalito powerplants before April 1, 1983, in accordance with a power sale contract dated November 29, 1967. The 1952–2007 entry includes the amounts of final settlement of payments made according to the contract.

*Line 22, Miscellaneous Revenues*, includes all other operating revenues not included in Lines 2 through 21.



*Line 23, Subtotal, Other Revenues*, is the total of Lines 16 through 22.

*Line 24, Total Operating Revenues*, is the total of Lines 13, 14, 15, and 23.

*Line 25, Total Operating Revenues and Capital Resources Revenues*, is the total of Lines 1 and 24.

## Project Expenses

Project expenses include the following:

- operations, maintenance, and power costs;
- deposits to replacement reserves;
- deposits to special reserves;
- capital resources expenditures; and
- debt service.

Revenue bond proceeds earmarked for debt service during construction and the first year's operating expenses are deposited in the Central Valley Water Project Construction Fund and disbursed in accordance with resolutions authorizing the issuance of such bonds.

Water contractor revenues associated with operating costs and debt service attributable to projects financed by revenue bonds are deposited in the Central Valley Water Project Revenue Fund for appropriate disbursement. All other operating revenues are deposited in the California Water Resources Development Bond Fund-Systems Revenue Account and are disbursed in accordance with the following four priorities of use, as specified in the Burns-Porter Act:

- SWP OMP&R costs;
- general obligation bond debt service;
- repayment of expenditures from the California Water Fund; and
- deposits to a reserve for future SWP construction.

Project expenses are presented in Lines 26 through 36 of Table 14-2.

*Line 26, Project Operations, Maintenance, Power, and Replacement Costs*, shows the OMP&R portion of the historical and projected costs presented in Table 14-10, at the end of this chapter.

Table 14-10 and Line 26 of Table 14-2 also include the amounts of the operations and maintenance costs for the federal share of joint facilities and those OMP&R costs allocated to recreation, which are intended to be offset by revenues listed in Lines 16 and 17.

Allowances for cost escalations are included in OMP&R costs through 2009. Allowances for additional long-term price escalations in the future are not included in these estimates, because changes in OMP&R costs do not substantially affect the overall results of the financial analysis. (For the most part, changes in OMP&R costs cause direct offsetting changes in operating revenues.)

Power costs make up the major item of annual operating expenses for the SWP. Assumptions about future power sources and costs are discussed in Chapter 10, Power Resources. Line 26 also includes costs associated with power transactions that result in the sale of power not required for the delivery of water.

*Line 27, Deposits to Replacement Reserves*, shows funds set aside as required by contract for replacing existing SWP facilities. By December 31, 2007, \$106.8 million had been spent for replacement costs; the balance of the replacement reserve as of that date was \$15.9 million.

*Line 28, Deposits to Special Reserves Under Revenue Bond Financing*, includes two significant components: special reserve deposits related to revenue bonds and

capital resources revenue carryover from prior years used for construction in the current year. Special reserve deposits are the net of several income and expenditure items. Income items related to revenue bonds are:

- proceeds set aside to pay bond interest during construction (capitalized interest);
- proceeds set aside for first year operating costs (capitalized operations and maintenance);
- water contractor payments or bond proceeds set aside for debt service reserves;
- water contractor payments for revenue bond cover requirements; and
- deposits to and withdrawals from operating reserves to meet day-to-day cash flow requirements.

The 1952–2007 column also includes advances to DWR’s revolving fund for working funds to purchase mobile equipment and to meet day-to-day operating expenses.

The expenditure items related to revenue bonds include:

- debt service cover payments returned to contractors;
- debt service reserve interest payments returned to contractors;
- surplus account funds returned to contractors or applied to meet expenses;
- total capitalized interest paid out; and
- total capitalized operations and maintenance paid out.

Special reserves, reduced over time as reserved amounts, are used for their respective purposes. The amount indicated each year in Line 28 indicates the change from the previous year. A negative number indicates a withdrawal of special reserves to meet expenses, while a positive number indicates a deposit.

*Line 29, Capital Resources Expenditures*, includes the amount of capital resources revenues applied to construction that is shown in Line 35 of Table 14-1. In Table 14-2, these expenditures are funded out of withdrawals from the reserves in Line 28 and do not affect net revenues shown in Line 38.

*Lines 30 and 31, Payment of Debt Service on Bonds Sold through December 31, 2007*, show the total principal and interest payments, respectively, on bonds sold to date. Table 14-11, at the end of this chapter, summarizes payments on general obligation bonds (Series A through Y water bonds), power revenue bonds by project, and water system revenue bonds (Series A through AD).

*Lines 32 and 33, Payments on Projected Future Water Bonds*, include the projected annual debt service amounts for future water revenue bonds included on Lines 25, 27, and 29 of Table 14-1 for the East Branch Extension, South Bay Aqueduct Enlargement, and other water system facilities.

Assumptions about the service on these future bonds are that interest costs for the water revenue bonds average 4.5 percent; and that bonds are to be repaid by the end of the project repayment period (2035) or sooner, with maturities commencing in the year following the date of sale and with equal annual bond service for the principal repayment period.

*Lines 34 and 35, Total Payments of Bond Debt Service*, show the total of principal payments indicated on Lines 30 and 32, and the total of interest repayments indicated on Lines 31 and 33.

*Line 36, Subtotal, Debt Service*, is the total of Lines 34 and 35.

*Line 37, Total Operating Expenses and Debt Service*, is the total of Lines 26, 27, 28, 29, and 36.

*Line 38, Net System Revenues*, shows the annual amounts of revenues remaining after the payment of operating costs and bond debt service costs.

*Line 39, California Water Fund Repayment*, shows the total amount of repayments made to the California Water Fund to reimburse the fund for monies expended for construction of the State Water Resources Development System.

Repayment of the California Water Fund was completed in 1998 after reimbursements totaling \$508 million. In addition to the \$296 million of repayments shown in Line 39, \$212 million of reimbursement was credited to the SWP as offsets for recreation and fish and wildlife enhancement expenditures.

*Line 40, Revenues Used for Capital Expenditures*, includes the amounts required annually for financing scheduled capital expenditures. Revenues not needed for operating costs or debt services are available for financing SWP capital expenditures.

## Future Costs of Water Service

Estimates of future water costs are useful to contractors for short-range and long-range planning of water needs, operations, and budgets. Unit water charges shown in Table 14-12 represent costs of water delivery by service area for calendar years 2009 and 2014. The unit rates include costs of existing and future SWP facilities accounted for in Table 14-1 and Table 14-7. The unit charges are based on the assumption that in 2009 and 2014, the SWP will be able to deliver the entire amount of water requested by each contractor. The unit water charges included in Table 14-12 are listed both as 2009 dollars and as escalated rates reflecting assumed future inflation of 5 percent per year through 2014.

**Table 14-12 Estimated Unit Water Charges for 2009 and 2014, by Service Area (Dollars per Acre-Foot)**

Service Area and Charge	2009	2014
	(In 2009 Dollars)	(In 2014 Dollars)
<b>Feather River Area</b>		
Capital; Operations, Maintenance, and Replacement (OM&R)	43	55
<b>North Bay Area</b>		
Capital; OM&R	207	264
Power	38	48
<b>Total</b>	<b>245</b>	<b>312</b>
<b>South Bay Area</b>		
Capital; OM&R	137	175
Power	67	86
<b>Total</b>	<b>204</b>	<b>261</b>
<b>Coastal Area</b>		
Capital; OM&R	542	692
Power	177	226
<b>Total</b>	<b>719</b>	<b>918</b>
<b>San Joaquin Area</b>		
Capital; OM&R	73	93
Power	31	40
<b>Total</b>	<b>104</b>	<b>133</b>
<b>Southern California Area</b>		
Capital; OM&R	184	235
Power	212	271
<b>Total</b>	<b>396</b>	<b>506</b>

**Table 14-1 Capital Requirements and Financing, December 31, 2007 (Thousands of Dollars)**

Line Number/Item	Calendar Year										
	1952-2007	2008	2009	2010	2011	2012	2013	2014	2015	2008-2015	1952-2015
<b>Capital Requirements</b>											
1. Initial Project Facilities	2,202,316	0	0	0	0	0	0	0	0	0	2,202,316
2. North Bay Aqueduct	94,565	3,823	8,162	3,854	2,660	5,938	25,000	140,000	180,000	369,437	464,002
3. Delta & Suisun Marsh Facilities	259,642	14,906	8,247	2,458	1,856	1,856	1,856	1,458	1,458	34,095	293,737
4. Final 4 Units at Banks Pumping Plant	43,673	0	0	0	0	0	0	0	0	0	43,673
5. Coastal Branch Aqueduct	508,890	0	0	0	0	0	0	0	0	0	508,890
6. West Branch Aqueduct	199,624	15	0	0	0	0	0	0	0	15	199,639
7. East Branch Enlargement	453,459	6,923	14,773	34,677	60,659	67,704	71,538	71,774	71,732	399,780	853,239
8. East Branch Improvements	322,421	1,678	11,770	350	0	0	0	0	0	13,798	336,219
9. East Branch Extension	120,645	15,050	20,414	85,680	92,675	31,605	7,600	1,000	1,000	255,024	375,669
10. South Bay Aqueduct Improvements and Enlargement	71,582	46,439	43,422	20,870	0	0	0	0	0	110,731	182,313
11. Power Generation and Transmission Facilities	703,876	12,320	7,900	8,000	8,100	6,900	0	0	0	43,220	747,096
12. Additional Conservation Facilities	151,904	4,628	4,628	4,628	4,054	4,054	4,054	4,054	4,054	34,154	186,058
13. Agricultural Drainage Facilities	72,486	3,362	3,362	3,362	3,362	3,362	3,362	3,362	3,362	26,896	99,382
14. Other Costs	363,804	20,765	38,238	204,631	131,403	73,675	4,150	0	0	472,862	836,666
15. <i>Subtotal, Project Construction Expenditures</i>	<i>5,568,887</i>	<i>129,909</i>	<i>160,916</i>	<i>368,510</i>	<i>304,769</i>	<i>195,094</i>	<i>117,560</i>	<i>221,648</i>	<i>261,606</i>	<i>1,760,012</i>	<i>7,328,899</i>
16. Davis-Grunsky Act Program Costs	130,000	0	0	0	0	0	0	0	0	0	130,000
17. Special Capital Requirements Under Revenue Bond Financing	597,040	48,836	15,735	15,773	61,848	11,091	18,568	8,126	46,756	226,733	823,773
<b>18. Total Capital Requirements</b>	<b>6,295,927</b>	<b>178,745</b>	<b>176,651</b>	<b>384,283</b>	<b>366,617</b>	<b>206,185</b>	<b>136,128</b>	<b>229,774</b>	<b>308,362</b>	<b>1,986,745</b>	<b>8,282,672</b>
19. Power Facilities Capital Requirements	703,876	12,320	7,900	8,000	8,100	6,900	0	0	0	43,220	747,096
20. Water Facilities Capital Requirements	5,592,051	166,425	168,751	376,283	358,517	199,285	136,128	229,774	308,362	1,943,525	7,535,576
<b>Financing of Capital Requirements</b>											
<b>Power Revenue Bond Proceeds</b>											
21. Power Revenue Bonds through Series H	1,162,458	0	0	0	0	0	0	0	0	0	1,162,458
<b>Water Revenue Bond Proceeds</b>											
22. East Branch Enlargement, Current Bonds	473,606	0	0	0	0	0	0	0	0	0	473,606
23. East Branch Enlargement, Future Bonds	0	7,700	16,500	38,600	67,400	75,300	79,500	79,800	79,800	444,600	444,600
24. East Branch Extension, Current Bonds	139,520	0	0	0	0	0	0	0	0	0	139,520
25. East Branch Extension, Future Bonds	0	10,300	22,700	95,200	103,000	35,100	8,400	1,100	1,100	276,900	276,900
26. So. Bay Aqueduct Enlargement, Current Bonds	16,938	0	0	0	0	0	0	0	0	0	16,938
27. So. Bay Aqueduct Enlargement, Future Bonds	0	113,800	48,200	23,200	0	0	0	0	0	185,200	185,200
28. Water System Facilities, Current Bonds	1,455,083	0	0	0	0	0	0	0	0	0	1,455,083
29. Water System Facilities, Future Bonds	0	356,500	69,500	0	447,800	0	98,300	0	386,000	1,358,100	1,358,100
30. <i>Subtotal, Water Revenue Bonds</i>	<i>2,085,147</i>	<i>488,300</i>	<i>156,900</i>	<i>157,000</i>	<i>618,200</i>	<i>110,400</i>	<i>186,200</i>	<i>80,900</i>	<i>466,900</i>	<i>2,264,800</i>	<i>4,349,947</i>
<b>Other Capital Financing</b>											
31. Initial Project Facilities Bond Proceeds	1,452,452	0	0	0	0	0	0	0	0	0	1,452,452
32. Davis-Grunsky Act Program Bond Proceeds	130,000	0	0	0	0	0	0	0	0	0	130,000
33. Application of CA Water Fund Monies (Tideland Oil Revenues)	508,056	0	0	0	0	0	0	0	0	0	508,056
34. Interim Financing	314,055	(314,055)	15,251	222,783	(256,083)	91,285	(54,572)	144,374	(163,038)	(314,055)	0
35. Application of Capital Resources Revenues to Construction	566,269	0	0	0	0	0	0	0	0	0	566,269
36. Revenue Transfers Applied	77,490	4,500	4,500	4,500	4,500	4,500	4,500	4,500	4,500	36,000	113,490
37. <i>Subtotal, Other Capital Financing</i>	<i>3,048,322</i>	<i>(309,555)</i>	<i>19,751</i>	<i>227,283</i>	<i>(251,583)</i>	<i>95,785</i>	<i>(50,072)</i>	<i>148,874</i>	<i>(158,538)</i>	<i>(278,055)</i>	<i>2,770,267</i>
<b>38. Total Financing of Capital Requirements</b>	<b>6,295,927</b>	<b>178,745</b>	<b>176,651</b>	<b>384,283</b>	<b>366,617</b>	<b>206,185</b>	<b>136,128</b>	<b>229,774</b>	<b>308,362</b>	<b>1,986,745</b>	<b>8,282,672</b>

**Table 14-2 State Water Project Revenues and Expenditures, December 31, 2007 (Thousands of Dollars)**

Line Number/Item	Calendar Year										
	1952-2007	2008	2009	2010	2011	2012	2013	2014	2015	2008-2015	1952-2015
<b>PROJECT REVENUES</b>											
1. Capital resources revenues	814,701	0	0	0	0	0	0	0	0	0	814,701
<b>Water Contractor Payments</b>											
2. Transportation capital	3,775,363	142,788	151,884	165,415	172,801	172,906	171,548	170,458	168,682	1,316,482	5,091,845
3. Transportation minimum	2,996,879	201,418	167,975	143,614	144,361	144,056	143,956	145,123	143,553	1,234,056	4,230,935
4. Transportation variable	4,185,270	301,426	229,959	323,671	318,028	343,769	391,900	422,870	434,896	2,766,519	6,951,789
5. Off-Aqueduct power facilities	2,411,981	132,604	142,091	144,154	141,011	141,221	78,250	20,072	11,892	811,295	3,223,276
6. Delta water charge	2,222,548	108,290	128,509	128,525	128,541	128,556	128,571	128,589	128,618	1,008,199	3,230,747
7. East Branch Enlargement	682,022	43,132	45,374	46,616	50,954	56,831	63,008	70,407	78,886	455,208	1,137,230
8. East Branch Extension	59,771	7,534	9,909	11,856	19,798	28,682	33,322	33,346	33,616	178,063	237,834
9. Coastal Extension	28,934	2,935	2,931	6,174	4,090	4,093	4,383	4,966	5,026	34,598	63,532
10. South Bay Aqueduct Improvements and Enlargement	2,203	1,212	10,412	14,389	16,345	16,345	16,350	16,348	16,347	107,748	109,951
11. Tehachapi East Afterbay	931	503	500	503	500	503	499	502	497	4,007	4,938
12. Water revenue bond surcharge	478,626	56,975	76,140	82,803	59,667	118,285	114,408	123,937	127,411	759,626	1,238,252
13. Subtotal, water contractor payments	16,844,528	998,817	965,684	1,067,720	1,056,096	1,155,247	1,146,195	1,136,618	1,149,424	8,675,801	25,520,329
14. Revenue bond cover adjustments	(592,758)	(42,209)	(45,234)	(46,369)	(50,163)	(53,189)	(50,328)	(51,696)	(53,159)	(392,347)	(985,105)
15. Rate management adjustments	(287,049)	(22,283)	(22,000)	(40,470)	(40,470)	(40,470)	(40,470)	(40,470)	(40,470)	(287,103)	(574,152)
<b>Other Revenues</b>											
16. Federal payments for project operating costs	270,505	15,515	15,515	15,515	15,515	15,515	15,515	15,515	15,515	124,120	394,625
17. Appropriations for operating costs allocated to recreation	16,657	0	0	0	0	0	0	0	0	0	16,657
18. Davis-Grunsky loan repayments	57,526	1,230	1,360	1,389	1,252	1,283	1,132	894	887	9,427	66,953
19. Revenue bond proceeds	652,977	0	0	0	0	0	0	0	0	0	652,977
20. Interest earnings on operating revenues	571,193	2,600	1,000	1,000	1,000	1,500	1,500	2,000	2,000	12,600	583,793
21. Oroville-Thermalito payments	249,279	0	0	0	0	0	0	0	0	0	249,279
22. Miscellaneous revenues	184,264	0	0	0	0	0	0	0	0	0	184,264
23. Subtotal, other revenues	2,002,401	19,345	17,875	17,904	17,767	18,298	18,147	18,409	18,402	146,147	2,148,548
<b>24. Total operating revenues</b>	<b>17,967,122</b>	<b>953,670</b>	<b>916,325</b>	<b>998,785</b>	<b>983,230</b>	<b>1,079,886</b>	<b>1,073,544</b>	<b>1,062,861</b>	<b>1,074,197</b>	<b>8,142,498</b>	<b>26,109,620</b>
<b>25. Total operating revenues and capital resources revenues</b>	<b>18,781,823</b>	<b>953,670</b>	<b>916,325</b>	<b>998,785</b>	<b>983,230</b>	<b>1,079,886</b>	<b>1,073,544</b>	<b>1,062,861</b>	<b>1,074,197</b>	<b>8,142,498</b>	<b>26,924,321</b>
<b>PROJECT EXPENSES</b>											
26. Project operations, maintenance, power, and replacement costs	9,345,636	701,943	830,842	791,855	661,100	677,545	731,269	687,209	696,475	5,778,238	15,123,874
27. Deposits to replacement reserves	122,668	0	0	0	0	0	0	0	0	0	122,668
28. Deposits to special reserves	748,655	(21,939)	(223,388)	(111,228)	(7,973)	30,481	(20,711)	4,026	6,641	(344,091)	404,564
29. Capital resources expenditures	686,932	0	0	0	0	0	0	0	0	0	686,932
<b>Payments of Debt Service</b>											
30. Principal repayments on bonds sold through December 31, 2007 (current bonds)	2,174,865	131,475	141,339	147,005	155,434	162,364	153,940	156,265	157,070	1,204,892	3,379,757
31. Interest on bonds sold through December 31, 2007 (current bonds)	5,329,290	137,691	131,428	124,692	117,620	109,799	101,546	94,353	86,967	904,096	6,233,386
32. Future water bond principal repayments	0	0	9,629	13,360	17,485	33,100	37,425	44,238	48,624	203,861	203,861
33. Future water bond interest payments	0	0	21,975	28,601	35,064	62,097	65,575	72,270	73,920	359,502	359,502
<b>34. Total principal</b>	<b>2,174,865</b>	<b>131,475</b>	<b>150,968</b>	<b>160,365</b>	<b>172,919</b>	<b>195,464</b>	<b>191,365</b>	<b>200,503</b>	<b>205,694</b>	<b>1,408,753</b>	<b>3,583,618</b>
<b>35. Total interest</b>	<b>5,329,290</b>	<b>137,691</b>	<b>153,403</b>	<b>153,293</b>	<b>152,684</b>	<b>171,896</b>	<b>167,121</b>	<b>166,623</b>	<b>160,887</b>	<b>1,263,598</b>	<b>6,592,888</b>
36. Subtotal, debt service	7,504,155	269,166	304,371	313,658	325,603	367,360	358,486	367,126	366,581	2,672,351	10,176,506
<b>NET REVENUES</b>											
<b>37. Total Operating Expenses and Debt Service</b>	<b>18,408,046</b>	<b>949,170</b>	<b>911,825</b>	<b>994,285</b>	<b>978,730</b>	<b>1,075,386</b>	<b>1,069,044</b>	<b>1,058,361</b>	<b>1,069,697</b>	<b>8,106,498</b>	<b>26,514,544</b>
38. Net system revenues	373,777	4,500	4,500	4,500	4,500	4,500	4,500	4,500	4,500	36,000	409,777
<b>Application of Net System Revenues</b>											
39. California Water Fund repayment	296,287	0	0	0	0	0	0	0	0	0	296,287
40. Revenues used for capital expenditures	77,490	4,500	4,500	4,500	4,500	4,500	4,500	4,500	4,500	36,000	113,490

**Table 14-10 Operations, Maintenance, Power, and Replacement Costs, by Facility, Composition, and Purpose (Thousands of Dollars)**

Feature	Calendar Year										TOTAL
	1962-2007	2008	2009	2010	2011	2012	2013	2014	2015	2016-2035	
<b>Project Facility</b>											
Feather River facilities	840,383	34,741	40,621	36,371	29,914	29,457	30,684	29,070	28,881	624,455	1,724,577
North Bay Aqueduct	51,088	4,670	5,540	5,057	4,161	4,162	4,504	4,407	4,440	91,106	179,135
Delta facilities	576	0	0	0	0	0	0	0	0	0	576
Suisun Marsh	31,523	3,635	4,250	3,806	2,518	2,479	2,581	2,444	2,428	52,498	108,162
South Bay Aqueduct	169,426	17,806	21,142	19,325	15,853	15,856	17,259	16,927	16,952	332,973	643,519
California Aqueduct											
Delta to Edmonston	3,417,700	257,773	303,534	294,139	236,086	237,425	278,189	271,875	279,008	5,742,687	11,318,416
Edmonston to Perris	3,102,158	284,844	352,875	332,970	271,713	285,113	326,785	335,653	337,718	6,786,896	12,416,725
West Branch	(94,321)	(14,697)	(18,010)	(15,800)	(12,367)	(10,136)	(12,029)	(11,628)	(11,346)	(333,807)	(534,141)
Coastal Branch	227,237	18,244	21,738	19,958	16,364	16,422	18,045	17,826	17,879	352,871	726,584
East Branch Enlargement	50,415	5,328	7,688	6,924	5,626	5,535	5,766	5,476	5,471	104,718	202,947
Off-Aqueduct power-generating facilities	1,211,062	71,551	73,416	71,057	76,213	76,213	44,466	140	25	298	1,624,441
Recreation, planning, and CVP negotiations	4,664	683	683	683	683	683	683	683	683	13,660	23,788
Water quality monitoring	380,869	15,712	15,712	15,712	12,683	12,683	12,683	12,683	12,683	227,572	718,992
Davis-Grunsky Act Program	11,705	600	600	600	600	600	600	600	600	12,000	28,505
<i>Subtotal</i>	<i>9,404,485</i>	<i>700,890</i>	<i>829,789</i>	<i>790,802</i>	<i>660,047</i>	<i>676,492</i>	<i>730,216</i>	<i>686,156</i>	<i>695,422</i>	<i>14,007,927</i>	<i>29,182,226</i>
Payments to/credits from PG&E under Comprehensive Agreement	(59,848)	0	0	0	0	0	0	0	0	0	(59,848)
<b>Total OMP&amp;R Costs</b>	<b>9,344,637</b>	<b>700,890</b>	<b>829,789</b>	<b>790,802</b>	<b>660,047</b>	<b>676,492</b>	<b>730,216</b>	<b>686,156</b>	<b>695,422</b>	<b>14,007,927</b>	<b>29,122,378</b>
<b>Composition</b>											
Salaries and expenses of headquarters personnel	2,679,482	126,755	165,088	192,702	89,341	92,130	101,288	85,156	81,971	1,270,250	4,884,163
Salaries and expenses of field personnel	3,814,401	154,617	210,357	245,897	114,348	118,355	130,425	111,005	106,759	2,214,881	7,221,045
Pumping power											
Used by pumping plants	2,278,203	412,488	437,153	342,741	452,006	460,627	526,825	564,180	581,457	12,101,987	18,157,667
Produced by generation plants	(469,763)	(64,798)	(56,502)	(61,872)	(72,138)	(71,110)	(73,065)	(74,602)	(75,067)	(1,585,029)	(2,603,946)
Payments to/credits from PG&E under Comprehensive Agreement	(59,848)	0	0	0	0	0	0	0	0	0	(59,848)
Off-Aqueduct power generating facilities requirement	1,211,062	71,551	73,416	71,057	76,213	76,213	44,466	140	25	298	1,624,441
Oroville-Thermalito insurance premiums	12,151	277	277	277	277	277	277	277	277	5,540	19,907
Less portion of costs incurred during construction	(121,051)	0	0	0	0	0	0	0	0	0	(121,051)
<b>Total OMP&amp;R Costs</b>	<b>9,344,637</b>	<b>700,890</b>	<b>829,789</b>	<b>790,802</b>	<b>660,047</b>	<b>676,492</b>	<b>730,216</b>	<b>686,156</b>	<b>695,422</b>	<b>14,007,927</b>	<b>29,122,378</b>
<b>Project Purpose</b>											
Water supply and power generation	8,965,490	675,774	805,801	766,079	635,323	651,767	705,490	661,427	670,693	13,513,347	28,051,191
Payments to/credits from PG&E under Comprehensive Agreement	(59,848)	0	0	0	0	0	0	0	0	0	(59,848)
Recreation and fish and wildlife enhancement	166,222	12,192	11,064	11,800	11,800	11,800	11,800	11,800	11,800	236,000	496,278
Flood control	5,361	324	324	323	324	325	326	329	329	6,580	14,545
Miscellaneous purposes											
Federal share, San Luis and Delta facilities	255,707	12,000	12,000	12,000	12,000	12,000	12,000	12,000	12,000	240,000	591,707
Other (Davis-Grunsky, drainage, City of Los Angeles)	11,705	600	600	600	600	600	600	600	600	12,000	28,505
<b>Total OMP&amp;R Costs</b>	<b>9,344,637</b>	<b>700,890</b>	<b>829,789</b>	<b>790,802</b>	<b>660,047</b>	<b>676,492</b>	<b>730,216</b>	<b>686,156</b>	<b>695,422</b>	<b>14,007,927</b>	<b>29,122,378</b>

**Table 14-11 Annual Debt Service on Bonds Sold through December 31, 2007 (Thousands of Dollars)**

Calendar Year	Series A through Y Water Bonds		Oroville Revenue Bonds <sup>a</sup>		Pyramid Project Revenue Bonds <sup>b</sup>		Alamo Project Revenue Bonds <sup>b</sup>		Small Hydro Project Revenue Bonds <sup>b</sup>		Water System Facilities Water System Revenue Bonds <sup>c</sup>		Subtotal		Devil Canyon-Castaic Project Revenue Bonds		Reid Gardner Project Revenue Bonds <sup>d,e</sup>		South Geysers Project Revenue Bonds <sup>b</sup>		Bottle Rock Project Revenue Bonds <sup>b</sup>		East Branch Enlargement Project Water System Revenue Bonds <sup>c</sup>		Coastal Extension Facilities Water System Revenue Bonds <sup>c</sup>		East Branch Extension Facilities Water System Revenue Bonds <sup>c</sup>		South Bay Enlargement Facilities Water System Revenue Bonds <sup>c</sup>		Tehachapi East Afterbay Facilities Water System Revenue Bonds <sup>c</sup>		Grand Total	
	Principal	Interest	Principal	Interest	Principal	Interest	Principal	Interest	Principal	Interest	Principal	Interest	Principal	Interest	Principal	Interest	Principal	Interest	Principal	Interest	Principal	Interest	Principal	Interest	Principal	Interest	Principal	Interest	Principal	Interest	Principal	Interest	Principal	Interest
1964	0	3,333	0	0	0	0	0	0	0	0	0	0	0	3,333	0	0	0	0	0	0	0	0	0	0	0	0	0	0	0	0	0	0	3,333	
1965	0	11,114	0	0	0	0	0	0	0	0	0	0	0	11,114	0	0	0	0	0	0	0	0	0	0	0	0	0	0	0	0	0	0	11,114	
1966	0	18,764	0	0	0	0	0	0	0	0	0	0	0	18,764	0	0	0	0	0	0	0	0	0	0	0	0	0	0	0	0	0	0	18,764	
1967	0	26,911	0	0	0	0	0	0	0	0	0	0	0	26,911	0	0	0	0	0	0	0	0	0	0	0	0	0	0	0	0	0	0	26,911	
1968	0	37,761	0	3,876	0	0	0	0	0	0	0	0	0	41,637	0	0	0	0	0	0	0	0	0	0	0	0	0	0	0	0	0	0	41,637	
1969	0	47,460	0	10,448	0	0	0	0	0	0	0	0	0	57,908	0	0	0	0	0	0	0	0	0	0	0	0	0	0	0	0	0	0	57,908	
1970	0	53,290	0	13,145	0	0	0	0	0	0	0	0	0	66,435	0	0	0	0	0	0	0	0	0	0	0	0	0	0	0	0	0	0	66,435	
1971	0	63,035	0	13,145	0	0	0	0	0	0	0	0	0	76,180	0	0	0	0	0	0	0	0	0	0	0	0	0	0	0	0	0	0	76,180	
1972	0	69,149	1,260	13,112	0	0	0	0	0	0	0	0	1,260	82,261	0	0	0	0	0	0	0	0	0	0	0	0	0	0	0	0	1,260	82,261		
1973	1,200	69,347	1,330	13,042	0	0	0	0	0	0	0	0	2,530	82,389	0	7,708	0	0	0	0	0	0	0	0	0	0	0	0	0	0	2,530	90,097		
1974	3,000	69,533	1,400	12,969	0	0	0	0	0	0	0	0	4,400	82,502	0	7,708	0	0	0	0	0	0	0	0	0	0	0	0	0	0	4,400	90,210		
1975	5,000	69,366	1,475	12,893	0	0	0	0	0	0	0	0	6,475	82,259	0	7,708	0	0	0	0	0	0	0	0	0	0	0	0	0	0	6,475	89,967		
1976	7,000	69,657	1,555	12,811	0	0	0	0	0	0	0	0	8,555	82,468	0	7,708	0	0	0	0	0	0	0	0	0	0	0	0	0	0	8,555	90,176		
1977	10,200	69,298	1,635	12,727	0	0	0	0	0	0	0	0	11,835	82,025	0	7,708	0	0	0	0	0	0	0	0	0	0	0	0	0	0	11,835	89,733		
1978	12,700	69,286	1,635	12,537	0	0	0	0	0	0	0	0	18,475	81,823	0	7,708	0	0	0	0	0	0	0	0	0	0	0	0	0	0	18,475	89,531		
1979	13,650	68,660	11,585	12,275	0	0	0	0	0	0	0	0	25,235	80,935	0	7,708	0	0	0	0	0	0	0	0	0	0	0	0	0	0	25,235	88,643		
1980	16,050	67,941	3,265	11,739	0	7,900	0	0	0	0	0	0	19,315	87,580	0	7,708	0	0	0	0	0	0	0	0	0	0	0	0	0	0	19,315	95,288		
1981	18,050	67,078	4,885	11,444	0	7,292	0	0	0	0	0	0	22,935	85,814	0	7,708	0	5,312	0	0	0	0	0	0	0	0	0	0	0	0	22,935	98,834		
1982	19,250	66,130	17,920	10,968	0	7,292	0	0	0	0	0	0	37,170	84,390	0	7,708	0	14,347	0	0	0	0	0	0	0	0	0	0	0	0	37,170	106,445		
1983	20,520	65,111	21,110	10,147	0	7,292	0	2,449	0	3,727	0	0	41,630	88,726	900	7,708	0	35,719	0	4,777	0	6,017	0	0	0	0	0	0	0	0	42,530	142,947		
1984	21,785	64,036	10,005	9,013	640	7,292	0	4,198	0	3,727	0	0	32,430	88,266	955	7,647	0	35,719	0	5,647	0	10,315	0	0	0	0	0	0	0	0	33,385	147,594		
1985	22,555	62,892	12,700	8,628	675	7,238	0	4,198	0	3,727	0	0	35,930	86,683	1,010	7,583	9,425	27,209	0	5,647	0	10,315	0	0	0	0	0	0	0	0	46,365	137,437		
1986	23,830	61,705	11,435	7,859	715	7,377	0	4,263	0	3,537	0	0	35,980	84,741	1,070	7,515	3,805	32,882	0	5,516	1,240	10,315	0	4,021	0	0	0	0	0	42,095	144,990			
1987	25,495	60,452	11,715	7,188	790	7,513	265	4,329	0	3,348	0	4,952	38,265	87,782	1,135	7,442	4,860	32,605	0	5,386	1,305	10,253	0	9,651	0	0	0	0	0	45,565	153,119			
1988	26,770	59,120	6,685	6,664	830	7,447	280	4,314	345	3,348	710	11,037	35,620	91,930	1,205	7,366	5,065	32,295	580	5,521	1,390	10,849	995	9,875	0	0	0	0	0	44,855	157,836			
1989	28,145	57,790	33,705	5,513	875	7,378	295	4,298	365	3,328	1,148	14,373	64,533	92,680	1,275	7,284	7,820	27,557	709	5,646	1,565	11,592	1,078	10,104	0	0	0	0	0	76,980	154,863			
1990	29,385	56,436	10,385	4,301	930	7,305	320	4,279	405	3,304	1,227	19,555	42,652	95,180	1,355	7,198	6,675	29,781	761	5,596	1,678	11,491	1,134	10,048	0	0	0	0	0	54,255	159,294			
1991	30,365	55,034	12,055	3,922	980	7,227	335	4,257	430	3,276	2,129	27,569	46,294	101,285	1,435	7,107	7,170	29,302	818	5,535	1,791	11,376	1,197	16,856	0	0	0	0	0	58,705	171,461			
1992	31,745	54,193	14,135	2,985	2,395	5,308	1,260	3,086	960	2,553	5,108	28,411	55,603	96,536	1,520	7,010	8,950	27,188	1,934	4,136	4,575	7,942	2,583	22,241	0	0	0	0	0	75,165	165,053			
1993	33,390	52,670	13,755	2,237	1,525	5,688	755	3,300	445	2,640	4,577	29,965	54,447	96,500	1,610	6,907	8,820	26,953	901	4,256	3,264	8,385	3,040	21,428	0	0	0	0	0	72,082	164,429			
1994	35,075	51,231	35,225	934	1,580	5,634	780	3,274	695	2,569	5,910	38,223	79,265	101,865	1,705	6,799	77,105	26,273	1,588	4,072	3,374	8,270	4,567	20,752	0	0	0	0	0	167,604	168,031			
1995	36,280	49,703	0	0	1,635	5,570	805	3,242	745	2,536	8,064	37,879	47,529	98,930	1,810	6,684	5,420	19,230	1,695	4,004	3,521	8,133	4,979	20,499	0	0	0	0	0	64,954	157,480			
1996	37,520	48,024	0	0	2,320	5,486	1,055	3,203	3,135	2,464	10,459	58,170	54,489	117,347	1,920	6,561	49,465	18,130	3,043	3,908	3,682	7,974	4,771	23,240	0	0	0	0	0	117,370	177,160			
1997	37,215	46,365	0	0	1,695	5,274	875	3,073	585	2,283	14,375	67,910	54,745	124,905	2,035	6,432	7,515	15,255	1,825	3,696	3,861	7,741	6,300	23,702	0	1,981	0	76	0	76,281	183,788			
1998	37,295	44,736	0	0	1,770	5,237	910	3,059	625	2,258	16,754	68,585	57,354	123,875	2,155	6,295	5,045	16,144	1,935	3,637	4,030	7,508	6,760	23,966	0	1,829	0	229	0	77,279	183,483			
1999	38,220	43,132	0	0	1,845	5,141	960	3,005	680	2,229	18,701	68,085	60,406	121,592	2,285	6,160	9,310	11,659	2,081	3,549	4,240	7,318	7,518	25,033	0	1,808	65	2,931	0	85,905	180,050			
2000	39,510	41,469	0	0	1,925	5,045	1,010	2,955	610	2,197	19,536	66,901	62,591	118,567	2,420	6,040	9,870	11,194	1,950	3,448	4,470	7,096	8,974	24,652	0	1,808	915	2,928	0	91,190	175,733			
2001	40,600	39,751	0	0	2,250	4,949	1,155	2,901	780	2,272	20,944	66,418	65,729	116,291	2,565	5,912	10,365	10,757	2,045	3,344	4,720	6,855	9,425	24,187	0	2,131	950	2,889	0	95,799	172,366			
2002	41,740	37,984	0	0	2,460	4,619	1,280	2,788	950	2,192	23,918	63,128	70,348	110,681	2,720	5,773	11,185	10,011	2,225	3,075	5,265	6,323	9,817	23,098	335	2,311	1,245	3,481	0	103,140	164,753			
2003	43,590	36,159	0	0	2,500	4,429	1,315	2,672	940	2,110	23,442	60,439	71,787	105,809	2,885	5,626	2,135	9,314	2,335	2,890	5,445	5,939	9,988	18,444	245	2,310	1,105	4,277	0	95,925	154,609			
2004	45,730	34,244	0	0	2,500	4,291	1,330	2,598	970	2,059	26,396	60,952	76,926	104,144	3,055	5,470	2,210	9,228	2,425	2,758	5,610	5,634	9,883	20,820	220	2,298	2,045	5,538	0	232	139	102,374	156,261	
2005	46,985	32,242	0	0	2,727	3,992	1,461	2,406	1,327	1,963	23,064	57,886	75,564	98,489	3,240	5,305	8,825	9,127	2,759	2,563	5,959	5,237	3,669	20,105	305	2,155	2,124	5,968	0	559	197	102,445	149,705	
2006	48,275	30,																																



## Chapter 15

### SWP Education and Information

*“Science on a Sphere” was the centerpiece of an interactive California State Fair exhibit on climate change and water, cosponsored by the Department of Water Resources.*



## Significant Events in 2007

**P**ublic Affairs Office (PAO) news releases and media contacts helped Department of Water Resources (DWR) officials convey important messages on State Water Project (SWP) activities, including Delta pumping adjustments, water supply developments, drought impacts, and conservation efforts.

During May, DWR observed Water Awareness Month for the 20<sup>th</sup> consecutive year, helping Californians adapt to conserving water in a developing major California drought.

In December, the death of David N. Kennedy, who had served as DWR Director for 15 years prior to his retirement, saddened California's water community while inspiring many with the legacy of his leadership.

During 2007, the SWP Tours program welcomed 31 foreign tours with 292 visitors to selected SWP facilities. Tour groups came from all over the United States and 12 other countries: Armenia, Canada, China, Congo, England, Germany, India, Iran, Japan, South Korea, the Netherlands, and Uganda. The Delta Tour program for DWR employees, a component of the DWR Training Program, continued, with three Delta Tours completed. There were also several school tours of the SWP.

*Information for this chapter was provided by the Public Affairs Office.*

The Department of Water Resources' (DWR) Public Affairs Office (PAO) functions as an information link between DWR and the public, most often involving the news media. PAO provides information about DWR's mission, programs and activities. Written communication, websites, and publications are often used. So too, are sophisticated graphics, artwork, video, photography, exhibits, tours, visitors centers' exhibits and displays, and special events.

## News Topic Highlights

### Snow Surveys

DWR conducts five monthly Sierra snow surveys each year to help gauge water supply conditions. The surveys begin in December or January and are completed in the spring, usually in late April or early May. The 2007 snowpack figures at the final survey indicated a statewide Sierra snowpack just 27 percent of average, signaling a dry year for California water supply. This compared with a 136 percent snowpack the previous year.

The PAO encourages media coverage of DWR's snow surveys to promote public awareness of the importance and uncertainty of water supplies in California. News releases were issued for each of the snow surveys. Interviews were arranged for reporters seeking additional information and water management perspectives.

### Drought Conditions

In June, alerting the public to drought challenges, the Governor urged Californians to increase water conservation and advocated an effort to modernize California's aging water infrastructure to improve supply reliability. DWR officials and program managers implemented conservation measures and provided technical advice and assistance to other water agencies and the public.

In July, DWR announced that it would sponsor 11 drought workshops throughout California to help urban water supply districts in their conservation campaigns.

### Delta Pumping

The tiny Delta smelt, an endangered species, played a starring role in California water activities during 2007, as reflected in DWR news announcements.

After finding smelt at the Banks Pumping Plant, DWR voluntarily suspended State Water Project (SWP) pumping for 10 days, starting on May 31. "The shutdown shines a bright light on the delicate balancing act that California's aging water system strikes each day, between preserving the environment and meeting our State's thirst for water," commented DWR Director Snow. Pumping resumed gradually on June 10.

Earlier in May, DWR appealed an April 18 court order giving it 60 days to shut down SWP export pumps unless it received Department of Fish and Game (DFG) authorization to "take" protected Delta smelt and Chinook salmon. In April, May, and June, Director Snow and other water leaders repeatedly briefed the news media on the Delta pumping situation.

DWR adjusted its SWP pumping in December to comply with a December 14 decision by federal Judge Oliver Wanger to safeguard Delta smelt. While accommodating the judicial decision with substantial

cuts in pumping, DWR officials noted that fish protection and environmental concerns underscored a growing need to protect the Delta while improving water supply reliability.

## Flood Protection

In October 2007, the Governor signed a package of flood legislation to strengthen flood protection in California. The flood bills will lead to development of a comprehensive Central Valley Flood Protection plan. This legislation will also change the name of the Reclamation Board to the Central California Flood Protection Board, effective in 2008. Major steps were taken toward evaluating and repairing levee sites on the Sacramento and San Joaquin rivers and in the advancement of flood safety planning.

## Climate Change Activities

Throughout 2007, climate change emerged as a rising concern in California's water community. DWR played a leading role in climate change response activities.

In a January 31 speech, Director Snow outlined a plan to ensure California's water future in the face of global climate change. He detailed the Governor's proposal for investing \$5.95 billion in added water storage, improvements to the Delta ecosystem, and water conservation.

From May 16 to 18, DWR cosponsored a Climate Change Workshop with the Western Governors Association and the Western States Water Council. Climate change was a featured element in a special DWR and National Weather Service exhibit at the 2007 California State Fair. In September, DWR signed an agreement with the National Oceanic and Atmospheric Administration's (NOAA) Climate Program Office to establish a process for coordinating climate research applicable to water management.

## Death of David N. Kennedy

David N. Kennedy, Director of DWR from 1983-1998, died in Sacramento on December 23, 2007. He was 71. He was the sixth DWR director, and served in that capacity longer than any previous director. Initially appointed by Governor Deukmejian, and reappointed by Governor Wilson, his leadership saw California through major floods in 1986, 1997, and 1998, as well as the longest statewide drought in modern history, from 1987 to 1992. DWR Director Snow said, "California has lost a great water leader and dedicated public servant." Kennedy's obituary was issued in a DWR news release on December 26, 2007. Articles memorializing his life and career are being prepared for publication in the *DWR NEWS/People* Winter 2008 issue.

## News Events

The following are samples of significant DWR news events promoted by the PAO during 2007.

In January, DWR announced completion of levee structural repairs at 19 additional sites due to high risk in urban areas along the Sacramento and San Joaquin rivers. These are among 71 sites the U.S. Army Corps of Engineers (Corps) determined to be critically damaged. The repairs indicate the State's high priority placed on improving flood safety.

On February 26, DWR announced it would hold a series of six public workshops to discuss Flood Bond Funding. Analysts and flood managers will discuss how Proposition 1E and 84 flood bond funds will be invested. On February 27, DWR released its annual *Bond Expenditure Disaster Preparedness and Flood Prevention Plan*.

On March 1, DWR Chief Deputy Director Nancy Saracino testified before a Congressional subcommittee in support of a multiagency program to restore a

major portion of the San Joaquin River. On March 5, DWR released its *Pelagic Fish Action Plan* to address the recent years' decline of pelagic fish species in the San Joaquin-Sacramento Delta.

On March 30, DWR began helicopter surveys along 350 miles of urban levees from Lathrop to Marysville, part of a sophisticated levee evaluation program.

DWR's May 1 snow survey showed Sierra snowpack at a critically lower than average stage. Water leaders stated the dry conditions show the need for conservation now and more water storage in the future. During May, DWR observed the 20<sup>th</sup> annual Water Awareness Month, promoting the message: Use Water Wisely.

At the Association of California Water Agencies (ACWA) Spring Conference in May, the Governor gave a speech on water policy, advocating a major program to renovate the State's aging infrastructure. On May 10, DWR announced a new climate change web portal to enable viewers to track DWR's climate change related activities.

On June 25, the first California Water Plan 2009 Regional Update Workshop was held in Oakland, the first of nine regional workshops statewide.

In July, DWR announced acquisition of three emergency communication trailers for use at strategic locations during emergency responses to such events as floods, earthquakes, or tsunamis. On July 17, the Governor announced that DWR would immediately take a series of steps to improve Delta conditions, help restore its ecosystem, and protect fish.

On August 21, the Governor and U.S. Senator Dianne Feinstein met and heard presentations by top water experts working to heal the Sacramento-San Joaquin Delta, a key water source for at least

some of the water supply to an estimated 25 million Californians.

On September 17, the Governor called a special session for the Legislature to consider a comprehensive \$5.9 billion water plan he and Senator Feinstein proposed. Earlier, on September 10, Director Snow had described DWR activities to safeguard the SWP and other California water systems from invasion by quagga and zebra mussels.

On October 10, the Governor signed a package of six bills relating to improved flood protection in California. One major bill renamed the Reclamation Board as the Central Valley Flood Protection Board, effective in 2008. It also mandated development of a comprehensive Central Valley Flood Protection Plan, under board supervision.

During November, DWR announced a series of workshops to provide an overview of water conditions and to analyze the water outlook for calendar year 2008. DWR emergency officials worked with fire authorities during extensive Southern California wildfires. On November 21, DWR officials announced an initial SWP allocation for water deliveries in 2008: an amount of water equal to 25 percent of contractors' requests.

## Community Relations

### 2007 California State Fair

For the 2007 California State Fair, DWR and NOAA cosponsored "Science on a Sphere" an exhibit that featured a global climate and weather education focus. The six-foot round, free-hanging video display globe showed science-based visuals of hurricanes, global warming, and floods. It proved to be highly popular with fair visitors.

## SWP Publications

### E-News

PAO continued to distribute electronic news articles on water-related issues via email. These news clippings were distributed to DWR employees under the heading of *California Water News*. The news items help keep program managers and staff aware of water issue developments, especially those relevant to DWR programs and activities.

### DWR NEWS/People

DWR's quarterly magazine, *DWR NEWS/People*, drew attention to DWR programs and activities, while recognizing the team and individual achievements of DWR employees.

The Summer 2007 edition showcased two major restoration efforts in which DWR plays a leading role: restoration programs for the Salton Sea and for a 153-mile portion of the San Joaquin River.

The Fall 2007 issue featured articles tracing the history and development of two major DWR reports: *Bulletin 132*, summarizing SWP activities on an annual basis; and the *California Water Plan*, an influential report on California's water supply and demand, published at five-year intervals.

Throughout the year, the magazine published articles dealing with a variety of topics. These included an update on South Bay Aqueduct expansion, the operations of SWP contracting agencies, and DWR's efforts to safeguard the SWP from invasive quagga mussels. Veteran DWR Hydrologist Maury Roos contributed an article that vividly depicted his 50 years of dealing with California floods.

## Community Outreach

### SWP Visitors Centers

The SWP visitors centers have exhibits, films, and photos that tell the story of the SWP

and the importance of water to our everyday lives. Figure 15-1 shows the locations of SWP visitors centers.

### School Education Program

The School Education Program's goal is to provide students and educators with a statewide perspective on water issues such as conservation, conveyance systems, and the water cycle. The PAO staff develops and promotes high-quality materials and provides them free of charge to schools, educators, and water districts. Program achievements for 2007 follow.

### Public Events and Outreach

PAO provided a display of DWR's Interactive Children's Exhibits at the following:

- Jack Splash event, Oroville (March);
- Urban Creeks Council's Creek Week event held at the Sacramento Discovery Center (April);
- Castaic Lake Fishing event (May);
- Hooked On Fishing, Oroville (June); and
- DWR booths at the following events: Fred Hall (March), Redwood Acres Fair (June), California State Fair (August–September), Salmon Festival (September), Pittsburg Seafood Festival (September), and a Catch A Special Thrill (C.A.S.T.) event at Millerton Lake (October).

### Outreach to Teachers and Educators

In 2007, the PAO staff was actively involved in presenting DWR's School Education Program and materials to teachers at the following events:

- the Bay Area Environmental Education Resource Fair in San Rafael (January);
- the California Regional Environmental Education Community (CREEC) Conference, Berkeley (February);
- the California Association of Bilingual Education Conference in San Jose (March); and

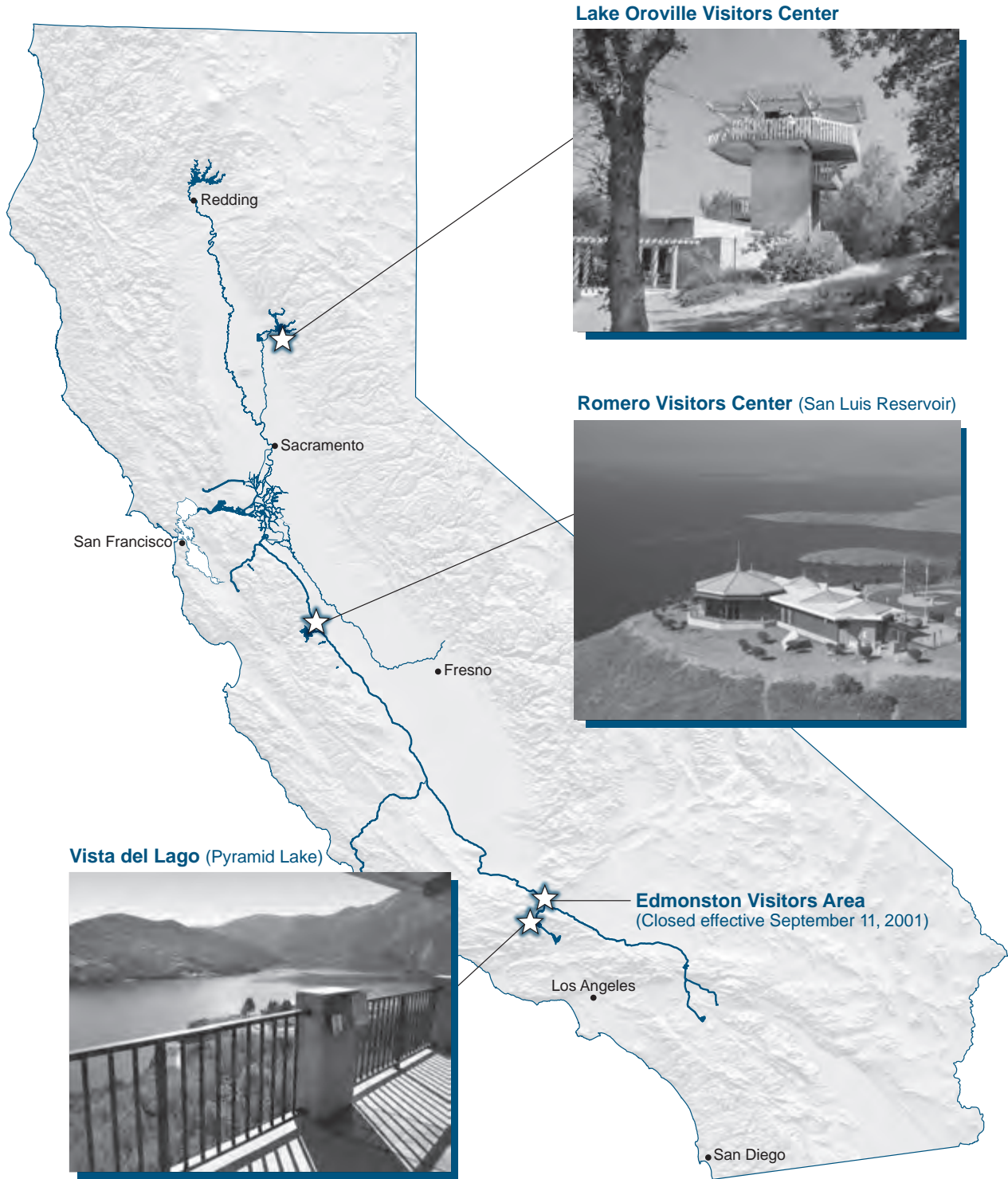


Figure 15-1 Visitors Centers on the SWP

- the California Science Teachers Association Conference, San Francisco (October).

### **Publications and Materials**

Additional 2007 program achievements include providing curriculum materials and children's videos to California teachers and water agencies through the *Water Facts and Fun* online catalog and promotional events. In order to provide materials, the following items were purchased or reprinted:

- 20,000 *California's Amazing Delta* book covers;
- 5,000 *Water and Me* student books;
- 5,000 Hamburger activity sheets for students;
- 600 California Science Standards Related to Water;
- 10,000 Water Conservation Pledges;
- 3,300 *I Make Every Drop Count* stickers;
- 16,000 *California Water Works and Why It Does* books for students;
- 2,000 children's program DVDs;
- 500 Project WET (Water Education for Teachers) books, which were provided to teachers who participated in Project WET training workshops; and
- 2,000 black mesh water cycle bags for teachers.

### **Collaboration/Partnerships**

Wherever possible, DWR's School Education program seeks to partner with other entities with similar interests and goals to pool resources in educating California's youth on the importance of our water resources. The following collaborative efforts occurred in 2007.

- Participated on the California Water Awareness Campaign education subcommittee, and purchased 7,500 copies of book #5: *Water Quality*, with a special emphasis on pollution and what individuals can do to protect the

cleanliness of our water supply.

- Facilitated DWR's Water Education Committee meetings, March 20–21, 2007, hosted by the San Diego County Water Authority; and September 26–27, 2007, hosted by the Sonoma County Water Agency.
- Participated on the Project WET Advisory Committee and the California Environmental Education Interagency Network (CEEIN) Committee.
- Participated on the Creek Week Planning Committee with DWR providing artwork for a poster, brochures, and a bookmark for Creek Week.

Collaborative efforts also included providing support for the following:

- the Environmentality Challenge for fifth grade students, in conjunction with the State of California and the Walt Disney Corporation;
- the California Department of Education's CREEC Network; and
- the Delta Studies Institute for teachers, cosponsored with the San Joaquin County Office of Education.

**Appendix B**  
**Data and Computations**  
**Used to**  
**Determine 2009 Water Charges**

---

**Contents**

	<b>Page</b>
Types of Water Charges .....	B-1
Composition and Timing of Water Charges.....	B-4
Bases for Allocating Reimbursable Costs Among Contractors.....	B-7
Capital and Minimum OMP&R Costs .....	B-7
Variable OMP&R Costs .....	B-10
Water Conveyance .....	B-11
Bases for Reimbursable Costs .....	B-14
Capital Costs .....	B-14
Annual Operating Costs.....	B-15
Transportation and Devil Canyon-Castaic Contract Costs .....	B-15
Conservation Capital and Operating Costs.....	B-16
Project Water Charges.....	B-17
Transportation Charges .....	B-17
Delta Water Charges .....	B-24
Water System Revenue Bond Surcharge .....	B-24
Total Water Charges.....	B-24
Equivalent Total Water Charges.....	B-24
Equivalent Water Costs by Reach.....	B-25
East Branch Enlargement Facility Charges .....	B-25
East Branch Extension Phase 1 Facility Charges.....	B-27
Short-Term Agreements .....	B-27

**Figures**

B-1	Relationships of Data Used to Substantiate Statements of Charges .....	B-2
B-2	Relationships of Data Used to Substantiate East Branch Enlargement Charges .....	B-3
B-3	Composition of Delta Water Charge and Transportation Charge .....	B-5
B-4	Repayment Reaches and Descriptions.....	B-8



## Tables

1	Summary of Permanent Aqueduct Capacity Transfers .....	B-11
2	Project Purpose Cost Allocation Factors .....	B-13
3	Criteria for Amortizing Capital Costs of Transportation Facilities ..	B-18
4	Minimum OMP&R Costs of Reach 31A Assigned Directly to Kern County Water Agency .....	B-18
5	Summary of Off-Aqueduct Power Facility Charges and Credits .....	B-20
6	Projected Charges for Off-Aqueduct Power Facilities .....	B-20
7	Kilowatt-Hour per Acre-Foot Factors for Allocating Off-Aqueduct Power Facility Costs .....	B-21
8	Extra Peaking Charges for Additional Power, by Pumping Plant ....	B-22
9	Extra Peaking Charges for Additional Power, by Contractor .....	B-23
10	Determination of Factors for Distributing Capital and Minimum OMP&R Costs of East Branch Enlargement Facilities among Participating Contractors .....	B-26
11	Factors for Distributing Capital and Minimum OMP&R Costs of the East Branch Extension Facilities .....	B-28
12	East Branch Extension Facilities Debt Service for 2009 .....	B-28
B-1	Factors for Distributing Reach Capital Costs among Contractors ...	B-30
B-2	Factors for Distributing Reach Minimum OMP&R Costs among Contractors .....	B-32
B-3	Power Costs and Credits, Transmission Costs, and Annual Replacement Deposits for Each Aqueduct Pumping and Power Recovery Plant .....	B-34
B-4	Annual Table A Amounts to Project Water .....	B-37
B-5A	Annual Water Quantities Delivered from Each Aqueduct Reach to Each Contractor .....	B-41
B-5B	Annual Water Quantities Delivered to Each Contractor .....	B-57
B-6	Annual Water Quantities Conveyed through Each Pumping and Power Recovery Plant of Project Transportation Facilities .....	B-61
B-7	Reconciliation of Capital Costs Allocated to Water Supply and Power Generation .....	B-72
B-8	SWP Capital Costs of Requested Delivery Structures .....	B-73
B-9	Capital Costs of Requested Excess Peaking Capacity .....	B-74
B-10	Capital Costs of Each Aqueduct Reach to be Reimbursed through Capital Cost Component of Transportation Charge .....	B-76
B-11	Minimum OMP&R Costs of Each Aqueduct Reach to be Reimbursed through Minimum OMP&R Component of Transportation Charge .....	B-84
B-12	Variable OMP&R Costs to be Reimbursed through Variable OMP&R Component of Transportation Charge .....	B-93

## Tables (continued)

B-13	Capital and Operating Costs of Project Conservation Facilities to be Reimbursed through Delta Water Charge .....	B-97
B-14	Capital Costs of Transportation Facilities Allocated to Each Contractor .....	B-98
B-15	Capital Cost Component of Transportation Charge for Each Contractor .....	B-102
B-16A	Minimum OMP&R Component of Transportation Charge for Each Contractor .....	B-106
B-16B	Minimum OMP&R Component of Transportation Charge for Each Contractor for Off-Aqueduct Power Facilities .....	B-110
B-17	Unit Variable OMP&R Component of Transportation Charge.....	B-114
B-18	Variable OMP&R Component of Transportation Charge for Each Contractor .....	B-119
B-19	Total Transportation Charge for Each Contractor.....	B-123
B-20A	Calculation of Delta Water Rates .....	B-127
B-20B	Delta Water Rates by Facility.....	B-128
B-21	Total Delta Water Charge for Each Contractor.....	B-129
B-22	Water System Revenue Bond Surcharge for Each Contractor .....	B-133
B-23	Total Transportation and Delta Water Charge for Each Contractor .....	B-137
B-24	Equivalent Unit Charge for Water Supply for Each Contractor .....	B-141
B-25	Equivalent Unit Transportation Costs of Water Delivered from or through Each Aqueduct Reach .....	B-142
B-26	Capital Costs of Each Aqueduct Reach to Be Reimbursed through the Capital Cost Component of the East Branch Enlargement Transportation Charge .....	B-143
B-27	Minimum OMP&R Costs of Each Aqueduct Reach to be Reimbursed through Minimum OMP&R Component of the East Branch Enlargement Transportation Charge .....	B-145
B-28	Capital Costs of East Branch Enlargement Transportation Facilities Allocated to Each Contractor .....	B-147
B-29	Capital Cost Component of East Branch Enlargement Facilities Transportation Charge for Each Contractor .....	B-148
B-30	Minimum OMP&R Component of East Branch Enlargement Facilities Transportation Charge for Each Contractor .....	B-149
B-31	Total East Branch Enlargement Facilities Transportation Charge for Each Contractor.....	B-150

## Appendix B

### Data and Computations

#### Used to

### Determine 2009 Water Charges

The Department of Water Resources (DWR) annually furnishes Statements of Charges to the 29 long-term State Water Project (SWP) water supply contractors. Article 29(e) of the Standard Provisions for Water Supply Contracts, approved August 3, 1962, describes those statements:

*All such statements shall be accompanied by the latest revised copies of the document amendatory to Article 22 and of Tables B, C, D, E, F, and G of this contract, together with such other data and computations used by the State in determining the amounts of the above charges as the State deems appropriate.*

To comply with Article 29(e), DWR performs an annual comprehensive review and redetermination of all water supply and financial aspects of the SWP for the entire project repayment period. This annual redetermination is performed in accordance with Article 22(f) and Article 28 of the water supply contracts, which concern the Delta Water Rate and annual transportation charges, respectively.

Appendix B includes data used to document the redetermination of water charges to be paid by contractors during calendar year 2009. The information is based on established data about the SWP, both known and projected, as of June 30, 2008.

The computational procedures and interrelationships between tabulations in this appendix are outlined on Figure B-1 and Figure B-2. All tables referenced on Figures B-1 and B-2 follow this text.

### Types of Water Charges

Charges to SWP water supply contractors include the costs of facilities for the conservation and development of a water supply and the conveyance of such supply to SWP service areas. These facilities are classified as "Project Conservation Facilities" and "Project Transportation Facilities" in the Standard Provisions for Water Supply Contract. The names of the main facilities in each classification follow.

#### Project Conservation Facilities

- Frenchman Dam and Lake;
- Grizzly Valley Dam and Lake Davis;
- Antelope Dam and Lake;
- Oroville Dam and Lake Oroville;
- Oroville power facilities;
- Delta facilities;
- a portion of the California Aqueduct from the Delta to Dos Amigos Pumping Plant, and
- Sisk Dam, San Luis Reservoir, and Gianelli Pumping-Generating Plant

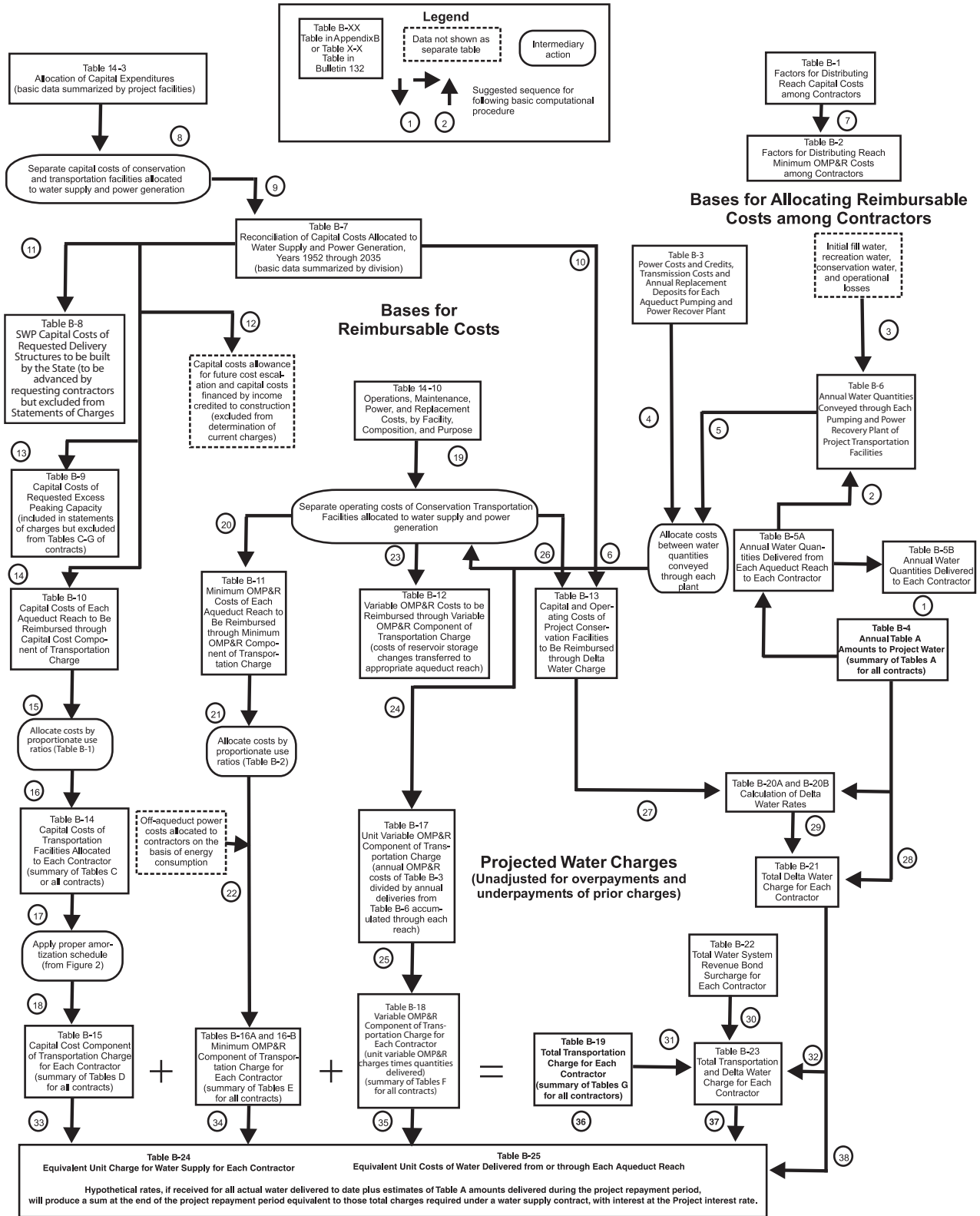
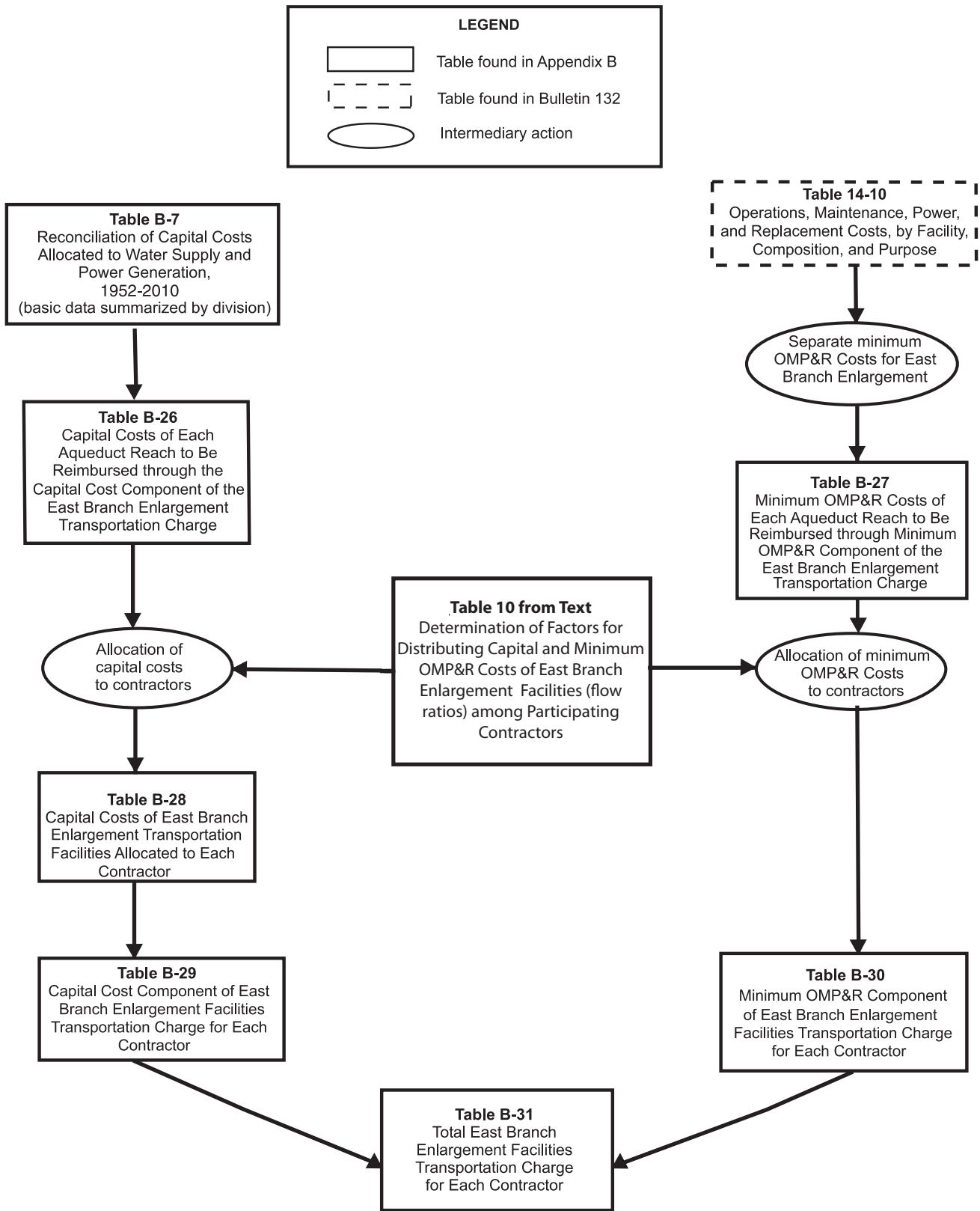


Figure B-1. Relationships of Data Used to Substantiate Statements of Charges



**Figure B-2. Relationships of Data Used to Substantiate East Branch Enlargement Charges**

Project Transportation Facilities

- Grizzly Valley Pipeline;
- North Bay Aqueduct;
- South Bay Aqueduct, including Del Valle Dam and Lake Del Valle;
- the remainder of the California Aqueduct from the Delta to Dos Amigos Pumping Plant and all facilities south, including dams and lakes in Southern California; and
- Off-Aqueduct Power Facilities (Reid Gardner Unit No. 4, Bottlerock Powerplant, and South Geysers Powerplant)

The standard provisions provide for a Delta Water Charge and a Transportation Charge for project water.

The Delta Water Charge is a unit charge applied to each acre-foot of SWP water the contractors are entitled to receive according to their contracts. The unit charge, if applied to each acre-foot of all such allocations for the remainder of the project repayment period, is calculated to result in repayment of all outstanding reimbursable costs of the Project Conservation Facilities, with appropriate interest, by the end of the repayment period (2035).

The Transportation Charge is for use of facilities to transport water to the vicinity of each contractor’s turnout. Generally, the annual charge represents each contractor’s proportionate share of the reimbursable capital costs and operating costs of the Project Transportation Facilities.

Each contractor’s allocated share of those reimbursable capital costs is amortized

for repayment to the State; and certain variations are allowed in the amortization methods. The contractors’ shares of reimbursable operating costs are repaid in the year such costs are incurred by the State.

The East Branch Enlargement Transportation Charge is paid by the seven Southern California contractors participating in the enlargement. San Bernardino Valley Municipal Water District advanced funds to pay the district’s allocated capital costs for the East Branch Enlargement. The remaining six contractors pay an allocated share of the debt service on revenue bonds sold to finance the enlargement. Each contractor also will pay an allocated share of the minimum operation, maintenance, power, and replacement costs (OMP&R) of the East Branch Enlargement.

Transportation charges for the Coastal Branch Extension, East Branch Extension, and South Bay Enlargement are being repaid by contractors in their respective service areas.

Transportation charges for the Tehachapi Afterbay are repaid by those contractors using electrical power for delivery of their Table A water downstream of the Tehachapi Afterbay.

**Composition and Timing of Water Charges**

As shown on Figure B-3, the Delta Water Charge and the Transportation Charge consist of the following three components:

- 1) Conservation and transportation capital cost components, which will

### Delta Water Charge

#### Capital Cost Component

1. Planning, design, right-of-way, and construction costs of Conservation Facilities
2. Operations and maintenance costs for newly constructed Conservation Facilities prior to initial operations
3. Activation costs for newly constructed Conservation Facilities
4. Power costs allocated to initial filling of San Luis Reservoir
5. Capitalized O&M costs (major repair work and so forth) for Conservation Facilities
6. Program costs (portion) to mitigate impacts on current Delta fishery population due to SWP pumping prior to 1986 (Department of Water Resources-Department of Fish and Game agreement)

#### Minimum OMP&R Component

1. Direct O&M costs of Conservation Facilities
  - a. Headquarters and field divisions (portion)
  - b. Insurance and FERC costs (portion)
2. General O&M costs allocated to Conservation Facilities
  - a. Contractor Accounting Office (portion)
  - b. Financial and contract administration (portion)
  - c. Water rights
  - d. Power planning for SWP facilities (portion)
3. Replacement deposits for SWP control centers (portion)
4. Credits for a portion of Hyatt-Thermalito power generation
5. Power costs and credits related to pumping water to San Luis Reservoir for project operations (storage changes)
6. Value of power used and generated by Gianelli Pumping-Generating Plant
7. Program costs (portion) to offset annual fish losses resulting from pumping at Banks Pumping Plant (Department of Water Resources-Department of Fish and Game agreement)

### Transportation Charge

#### Capital Cost Component

1. Planning, design, right-of-way, and construction costs of Transportation Facilities
2. O&M costs for newly constructed Transportation Facilities prior to initial operation
3. Activation costs for newly constructed Transportation Facilities
4. Power costs allocated to initial filling of Southern California reservoirs
5. Capitalized O&M costs (major repair work and so forth) for Transportation Facilities
6. Program costs (portion) to mitigate impacts on current Delta fishery population due to SWP pumping prior to 1986 (Department of Water Resources-Department of Fish and Game agreement)

#### Minimum OMP&R Component

1. Direct O&M costs of Transportation Facilities
  - a. Headquarters and field divisions (portion)
  - b. Insurance and FERC costs (portion)
2. General O&M costs related to Transportation Facilities
  - a. Contractor Accounting Office (portion)
  - b. Financial and contract administration (portion)
  - c. Power planning for SWP facilities (portion)
3. Power costs and credits related to pumping water to Southern California reservoirs for project operations (storage changes)
4. Power costs for pumping water to replenish losses from Transportation Facilities
5. Other power costs
  - a. Station service at Transportation Facility power and pumping plants
  - b. Transmission service costs related to "backbone" Transportation Facilities
6. Replacement deposits for SWP control centers (portion)
7. Off-Aqueduct Power Facility costs—bond service, bond cover costs (25 percent of bond service), bond reserves, transmission costs to provide service to backbone; fuel costs taxes, and O&M-less power sales allocated to Off-Aqueduct Power Facilities
8. Program costs (portion) to offset annual fish losses resulting from pumping at Banks Pumping Plant (Department of Water Resources-Department of Fish and Game agreement)

#### Variable OMP&R Component

1. Power purchase costs
  - a. Capacity
  - b. Energy
  - c. Pine Flat bond service, O&M, and transmission costs allocated to aqueduct pumping plants
2. Alamo, Devil Canyon, Warne, and Castaic power generation credited at the power plant reach and charged to aqueduct pumping plants
3. Hyatt-Thermalito Diversion Dam power plant generation charged to aqueduct pumping plants (credits for this generation are reflected in the Delta Water Rate)
4. Replacement deposits for equipment at pumping plants and power plants
5. Credits from sale of excess SWP system power
6. Program costs (portion) to offset annual fish losses resulting from pumping at Banks Pumping Plant (Department of Water Resources-Department of Fish and Game agreement)

Note: Excludes costs recovered under the East Branch Enlargement Transportation Charge.

**Figure B-3. Composition of Delta Water Charge and Transportation Charge**

return to the State all reimbursable capital costs;

- 2) Conservation and transportation minimum OMP&R components, which will return to the State all reimbursable operating costs that do not depend on or vary with quantities of water actually delivered to the contractors; and
- 3) A transportation variable OMP&R component, which will return to the State all reimbursable operating costs that depend on, and vary with, quantities of water actually delivered to the contractors.

The formula for computing the Delta Water Rate, Article 22(f) of the Standard Provisions for Water Supply Contract, was designed to ensure that all adjustments for prior overpayments or underpayments of the Delta Water Charge are accounted for in a redetermination of the rate. Since the redetermined rate applies to all future allocations, such adjustments are amortized during the remainder of the project repayment period. This appendix includes a redetermination of the Delta Water Rate for 2009.

Article 28 of the standard provisions stipulates that Transportation Charges be redetermined each year. The tables in Appendix B include the numerical data used in this redetermination. Transportation Charges for prior years through 2007 included in those tables are the redetermined amounts and do not equal the amounts actually paid by contractors.

As provided under the Water System Revenue Bond Amendment to the water supply contracts, differences between actual payments under the Transportation

capital cost component and amounts computed in this redetermination are accumulated with interest and amortized during the remaining years of the contract repayment period. All computations for adjustments are included in the attachments accompanying each contractor's Statement of Charges and are reflected in revised copies of Table C through Table G of the contract, which are also furnished to each long-term water supply contractor in the annual Statements of Charges.

These redeterminations exclude four charges associated with water service other than the Delta Water Charge and the Transportation Charge. The excluded charges (and the manner in which they are treated in this appendix) are outlined below.

- 1) Advances of funds pursuant to Article 24(d) of the standard provisions for excess capacity constructed by the State at the request of contractors.
- 2) Advances of funds pursuant to Article 10(d) of the standard provisions for delivery structures (turnouts) constructed by the State at the request of contractors. Partial information concerning actual and projected capital costs of such delivery structures is included in this appendix. Statements concerning these costs and data are furnished to the appropriate contractors at various times and are not part of the annual statements.
- 3) Payments for sale and service of surplus water to entities other than contractors, pursuant to Article 21 of the standard provisions, are also excluded. Those payments are generally based on the unit rates shown in Table B-25. Net revenues



resulting from noncontractor service are applied as indicated on page 24 of Bulletin 132-71.

- 4) Payments under the Devil Canyon-Castaic contract for costs of the Devil Canyon-Castaic facilities allocable to power generation. Charges billed as a result of the contract are billed separately from those billed as a result of the water supply contract. Information about the treatment of such charges in relation to redetermined Transportation Charges is included in special attachments to the bills of the six participating contractors.

The time and method of payment for corresponding components of the Delta Water Charge and the Transportation Charge are as follows:

- 1) The capital cost components of the Delta Water Charge and the Transportation Charge are paid in two semiannual installments, due January 1 and July 1 of each year, based on statements furnished by the State on or before July 1 of the preceding year.
- 2) The minimum OMP&R components of the Delta Water Charge and the Transportation Charge are paid in 12 equal installments, due the first of each month and based on statements furnished by the State on or before July 1 of the preceding year.
- 3) The variable OMP&R component of the Transportation Charge is paid in varying monthly amounts and is due the fifteenth day of the second month following actual water delivery. The charges are projected based on a unit charge per acre-foot established on or before July 1 of the preceding year. Those unit charges may be revised

during the year to reflect current power costs and revenues. The unit charges are applied to actual monthly delivery quantities as determined by the State on or before the fifteenth day of the month following actual water delivery.

## **Bases for Allocating Reimbursable Costs Among Contractors**

This section describes the procedures for allocating reimbursable costs of Project Transportation Facilities among contractors (see upper right portion of Figure B-1). Those costs do not include annual costs of Off-Aqueduct Power Facilities, which are explained in the section "Project Water Charges."

### **Capital and Minimum OMP&R Costs**

Figure B-4 includes information about the repayment reaches that form the basis for allocating reimbursable costs of the Project Transportation Facilities among contractors.

Allocations of reimbursable capital costs and minimum OMP&R costs of each reach are based on the proportionate maximum use of that reach by respective contractors under planned conditions of full development.

The derivation of ratios that represent the proportionate maximum use of each aqueduct reach by the respective contractors was first reported in Bulletin 132-70. The ratios in Bulletin 132-70 were subsequently revised for the North Bay Aqueduct, the South Bay Aqueduct, the

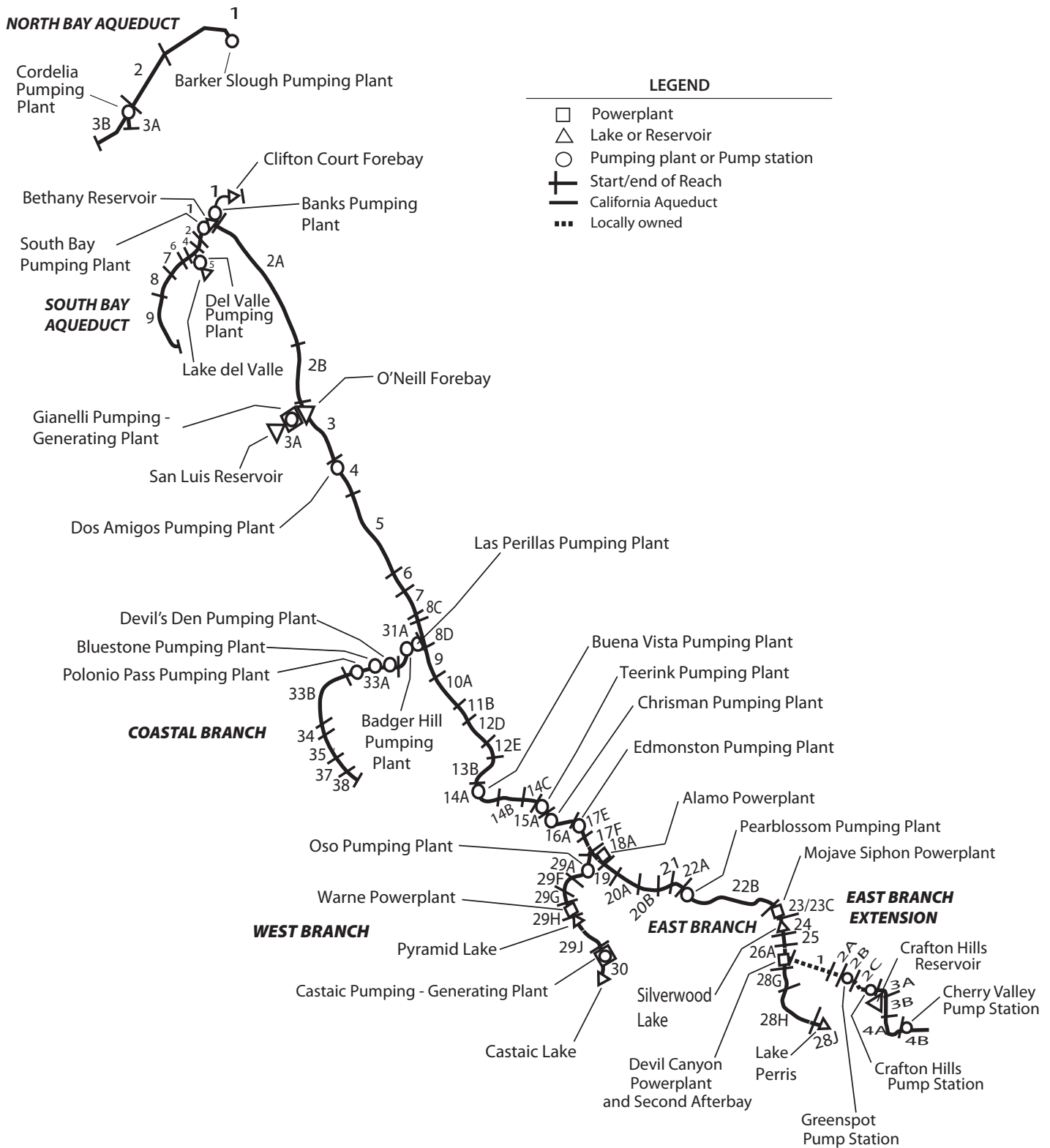


Figure B-4. Repayment Reaches and Descriptions

**North Bay Aqueduct**

- 1 Barker Slough through Fairfield /Vacaville Turnout
- 2 Fairfield/Vacaville Turnout to Cordelia Forebay
- 3A Cordelia Forebay through Benicia and Vallejo Turnouts
- 3B Cordelia Forebay through Napa Turnout Reservoir

**South Bay Aqueduct**

- 1 Bethany Reservoir through Altamont Turnout
- 2 Altamont Turnout through Patterson Reservoir
- 4 Patterson Reservoir to Del Valle Junction
- 5 Del Valle Junction through Lake Del Valle
- 6 Del Valle Junction through South Livermore Turnout
- 7 South Livermore Turnout through Vallecitos Turnout
- 8 Vallecitos Turnout through Alameda-Bayside No.1 Turnout
- 9 Alameda-Bayside Turnout through Santa Clara Terminal Facilities

**California Aqueduct****North San Joaquin Division**

- 1 Delta through Bethany Reservoir
- 2A Bethany Reservoir to Orestimba Creek
- 2B Orestimba Creek to O'Neill Forebay

**San Luis Division**

- 3A Sisk Dam, San Luis Reservoir, Gianelli Pumping-Generating Plant
- 3 O'Neill Forebay to Dos Amigos Pumping Plant
- 4 Dos Amigos Pumping Plant to Panoche Creek
- 5 Panoche Creek to Five Points
- 6 Five Points to Arroyo Pasajero
- 7 Arroyo Pasajero to Kettleman City

**South San Joaquin Division**

- 8C Kettleman City through Milham Avenue
- 8D Milham Avenue through Avenal Gap
- 9 Avenal Gap through Twisselman Road
- 10A Twisselman Road through Lost Hills
- 11B Lost Hills to 7th Standard Road
- 12D 7th Standard Road through Elk Hills Road
- 12E Elk Hills Road through Tupman Road
- 13B Tupman Road to Buena Vista Pumping Plant
- 14A Buena Vista Pumping Plant through Santiago Creek
- 14B Santiago Creek through Old River Road
- 14C Old River Road to Teerink Pumping Plant
- 15A Teerink Pumping Plant to Chrisman Pumping Plant
- 16A Chrisman Pumping Plant to Edmonston Pumping Plant

**Coastal Branch, California Aqueduct**

- 31A Avenal Gap to Devil's Den Pumping Plant
- 33A Devil's Den Pumping Plant through Tank 1
- 33B Tank 1 through Chorro Valley Turnout
- 34 Chorro Valley Turnout through Lopez Turnout
- 35 Lopez Turnout through Guadalupe Turnout
- 37 Guadalupe Turnout to SPRR crossing near Casmalia
- 38 SPRR crossing near Casmalia through terminous at Tank 5 (Outlet Vault)

**Tehachapi Division**

- 17E Edmonston Pumping Plant to Porter Tunnel
- 17F Porter Tunnel to Junction, West Branch

**Mojave Division**

- 18A Junction, West Branch through Alamo Powerplant
- 19 Alamo Powerplant to Fairmont
- 19C Buttes Junction through Buttes Reservoir
- 20A Fairmont through 70th Street West
- 20B 70th Street West to Palmdale
- 21 Palmdale to Littlerock Creek
- 22A Littlerock Creek to Pearblossom Pumping Plant
- 22B Pearblossom Pumping Plant to West Fork Mojave River
- 23 West Fork Mojave River to Silverwood Lake
- 23C Mojave Siphon Powerplant
- 24 Cedar Springs Dam and Silverwood Lake

**Santa Ana Division**

- 25 Silverwood Lake to South Portal, San Bernardino Tunnel
- 26A South Portals San Bernardino Tunnel through Devil Canyon Powerplant and Second Afterbay
- 28G Devil Canyon Powerplant and Second Afterbay to Barton Road
- 28H Barton Road to Lake Perris
- 28J Perris Dam and Lake Perris

**East Branch Extension**

- 1 Devil Canyon Powerplant to Junction, Foothill Pipeline near Cone Camp Road
- 2A Junction, Foothill Pipeline near Cone Camp Road to Greenspot Pump Station
- 2B Greenspot Pump Station to Morton Canyon Valve Vault
- 2C Morton Canyon Valve Vault to Crafton Hills Pump Station
- 3A Crafton Hills Pump Station to Carter Street Valve Vault
- 3B Carter Street Valve Vault to Garden Air Creek, South of San Bernardino/Riverside County Line
- 4A Garden Air Creek to Cherry Valley Pump Station
- 4B Cherry Valley Pump Station to Terminus at Noble Creek

**West Branch, California Aqueduct**

- 29A Junction, California Aqueduct through Oso Pumping Plant
- 29F Oso Pumping Plant through Quail Embankment
- 29G Quail Embankment through Warne Powerplant
- 29H Pyramid Dam and Lake
- 29J Pyramid Lake through Castaic Powerplant
- 30 Castaic Dam and Lake

California Aqueduct from the Delta to Castaic Lake, and the Coastal Branch.

All the revisions reported in previous bulletins regarding the derivation of ratios that represent the proportionate maximum use of each aqueduct reach by the respective contractors were last reported in Tables B-1 and B-2 of Bulletin 132-91. Under Article 53 of the Monterey Amendment, agricultural contractors may sell up to 130,000 acre-feet of aqueduct capacity to municipal and industrial contractors. The first permanent transfer occurred in 1998. Currently, 114,000 acre-feet of the allowable capacity has been transferred. Table 1 shows the permanent capacity transfers that have taken place since the Monterey Amendment was implemented in 1995.

*Table B-1* presents the reach ratios currently applicable to reimbursable capital costs.

*Table B-2* presents corresponding ratios for allocating 2009 and after reimbursable minimum OMP&R costs among contractors. Requested excess capacity is omitted when deriving ratios applicable to capital costs because the capital costs for the excess capacity are paid on an incremental-cost basis and not a proportionate-use basis. However, requested excess capacity is accounted for in the ratios applicable to minimum OMP&R costs.

### **Variable OMP&R Costs**

Article 26(a) includes provisions to ensure that the variable OMP&R component of the Transportation Charge will result in a return to the State of those costs that depend on and vary with the amount of

SWP water deliveries. (The minimum OMP&R component results in a return of those operating costs that do not vary with deliveries.) Under Article 26(a) all such costs for a reach for a given year will be allocated among contractors in proportion to the actual annual use of that reach by the respective contractors.

*Table B-3* summarizes the total power costs, credits, and transmission costs for each aqueduct pumping and power recovery plant. These variable costs are:

- costs of capacity and energy used exclusive of associated power transmission and station service charges (transmission and station service costs that are independent and vary with power usage are classified as minimum OMP&R costs);
- credits for capacity and energy produced at aqueduct power recovery plants (treated as negative costs);
- payments for replacement of major plant machinery components having economic lives shorter than the project repayment period. (In 1997, DWR discontinued charging for a sinking fund for replacements. Replacement costs, for 1999 and thereafter, are to be paid on an annual basis, as the costs are incurred.); and
- beginning in 2005, a portion of transmission expenditures that will depend on and vary with water and power usage. These costs will be included as part of the variable component. Costs reflect the revised 2008 transmission rate structure from Pacific Gas and Electric.

*Table B-3* excludes plant capacity and energy costs associated with surplus and unscheduled water service after

**Table 1. Summary of Permanent Aqueduct Capacity Transfers**

Contractor		Capacity Transfer		
Seller	Buyer	Amount (af)	Effective Year	Transfer Description
<b>Transfers under Monterey Amendment</b>				
Kern	Mojave	25,000	1998	Purchased capacity upstream from Reach 31A
Kern	Castaic Lake	41,000	2000	Purchased capacity upstream from Reach 16A
Kern	Palmdale	4,000	2000	Purchased capacity upstream from Reach 11B
Kern	Alameda-Zone 7	7,000	2000	Purchased capacity upstream from Reach 10A
Kern	Alameda-Zone 7	15,000	2000	Purchased capacity upstream from Reach 10A
Kern	Alameda-Zone 7	10,000	2001	Purchased capacity upstream from Reach 11B
Kern	Solano	5,756	2001	Purchased capacity upstream from Reach 11 B and Reach 31A
Kern	Napa	4,025	2001	Purchased capacity upstream from Reach 11B and Reach 31A
Kern	Alameda-Zone 7	2,219	2004	Purchased capacity upstream from Reach 11B
<i>Subtotal under Article 53</i>		114,000		
<b>Transfers outside of Monterey Amendment</b>				
Tulare	Dudley Ridge	3,973	2002	Purchased capacity upstream from Reach 8D
Tulare	AVEK	3,000	2002	Purchased capacity upstream from Reach 8D
Tulare	Alameda-Zone 7	400	2003	Purchased capacity upstream from Reach 8D
Tulare	Kings	5,000	2004	Purchased capacity upstream from Reach 8D
Tulare	Coachella	9,900	2004	Purchased capacity upstream from Reach 8D
MWDSC	Coachella	88,100	2005	Purchased capacity upstream from Reach 28J
MWDSC	Desert	11,900	2005	Purchased capacity upstream from Reach 28J
Tulare	Kings	305	2006	Purchased capacity upstream from Reach 31A
<i>Subtotal outside of Article 53</i>		122,578		

May 1, 1973. Prior to that date, surplus water service was charged the same unit variable OMP&R component as allocated water service. An amendment to the long-term water supply contracts in 1973 significantly changed the rate structure for surplus water service. Capacity and energy costs for pumping surplus and unscheduled water were allocated directly to those water contractors receiving surplus and unscheduled water service. A contract amendment in 1991 again revised the rate structure to provide for payment of costs through a melded power rate. These revisions to charges for surplus and unscheduled water are effective from the date of the amendments and are not applied to past charges.

An interruptible water program was established in 1994. This program is based on individual annual contracts; costs for interruptible water actually delivered are included in Table B-3.

### **Water Conveyance**

Tables B-4, B-5A, B-5B, and B-6 present water conveyance quantities that form the basis for allocating costs.

*Table B-4* presents the schedules of annual allocations as set forth in Table A and Article 6(a) of each water supply contract.

*Table B-5A* shows amounts of actual and projected allocated water quantities

delivered from each aqueduct reach to each contractor. Projected deliveries for years 2008 through 2035 are based on contractors' requests for future water deliveries. The quantities included in Table B-5A also include nonproject water delivered to contractors and surplus water deliveries prior to May 1, 1973, and actual interruptible water deliveries in 1994 and after.

Table B-5B presents a summary of actual and projected annual allocated water quantities for each contractor. The quantities also include amounts of nonproject water and surplus water delivered prior to May 1, 1973, and actual deliveries of interruptible water in 1994 and after.

Table B-6 summarizes the annual allocated water quantities conveyed or to be conveyed through each aqueduct pumping plant or power plant for each of the following functions:

- *Deliveries-Water Supply.* Water made available to contractors at down-aqueduct delivery structures, including certain hypothetical quantities to facilitate cost allocations, for those years when deliveries are made from net annual storage withdrawals. The net annual amounts of storage withdrawals are hypothetically added to the actual amounts conveyed from the Delta to the reservoirs, since deliveries made from storage withdrawals bear the same variable OMP&R costs per acre-foot as they would if the deliveries were actually conveyed from the Delta in that year. The hypothetical increases in the deliveries made from reservoir storage withdrawals are offset by equal credits

to the minimum OMP&R costs of the respective reservoirs. Thus, the variable OMP&R components per acre-foot (Table B-17) may be applied to the total annual quantities delivered either from aqueduct reservoir storage or from the Delta.

- *Initial Fill Water.* Water required for initial filling of down-aqueduct reaches and reservoirs or for repayment of pre-consolidation water used during construction.
- *Deliveries-Recreation.* Water delivered to down-aqueduct recreation developments or used for fish and wildlife enhancement.
- *Operational Losses.* Water lost through evaporation and seepage from all down-aqueduct reaches.
- *Reservoir Storage Changes.* Water placed in down-aqueduct reservoir storage after initial filling of the reservoirs, including projected net annual storage accretions (positive values) and withdrawals (negative values) for all down-aqueduct reservoirs of the Project Transportation Facilities.

Variable OMP&R costs (Table B-12) that are allocable to storage accretions are assigned to the minimum OMP&R costs of the respective reservoirs. With the exception of Banks Pumping Plant, "Reservoir Storage Changes" also includes SWP water placed into Southern California groundwater storage from 1978 through 1982 (as positive amounts); and water withdrawn from storage and delivered to contractors in 1979, 1982, 1987, 1988, and 1989 (as negative amounts). At Banks Pumping Plant, groundwater additions and withdrawals are included in "Conservation Water."

Table B-6 also summarizes the following two amounts under the heading “Conservation Water” (Column 25):

- 1) Net annual water amounts stored and projected to be stored in San Luis Reservoir.
- 2) Water lost and projected to be lost through evaporation and seepage from San Luis Reservoir and from the water conservation portion of the California Aqueduct.

“Conservation Water” includes initial fill water, operational losses, and net annual storage changes associated with San Luis Reservoir and the portion of the California

Aqueduct that is allocated to conservation. The same allocation procedure outlined previously for Transportation Facilities also applies to water delivered from storage in Conservation Facilities, except that the hypothetical cost increases are added to the variable OMP&R cost to be reimbursed through the Transportation Charge and deducted from the minimum OMP&R costs to be reimbursed through the Delta Water Charge.

San Luis Reservoir is operated to conserve water for future delivery to downstream contractors. To account for costs associated with reservoir storage, the power and replacement costs of Banks

**Table 2. Project Purpose Cost Allocation Factors (Percentages)**

	Water Supply and Power Generation		All Other Purposes (Nonreimbursable)	
	Capital Costs	Minimum OMP&R Costs	Capital Costs	Minimum OMP&R Costs
<b>PROJECT FACILITIES</b>				
<b>Project Conservation Facilities</b>				
Frenchman Dam and Lake	21.5	0.0	78.5	100.0
Antelope Dam and Lake	0.0	0.0	100.0	100.0
Grizzly Valley Dam and Lake Davis	1.0	1.8	99.0	98.2
Oroville Division <sup>a</sup>	97.1	99.5	2.9	0.5
California Aqueduct, Delta to Dos Amigos Pumping Plant	96.6	96.7	3.4	3.3
Delta Facilities				
Peripheral Canal Related	86.0	86.0	14.0	14.0
Remaining of Delta Facilities	96.6	96.7	3.4	3.3
<b>Transportation Facilities</b>				
Grizzly Valley Pipeline	100.0	100.0	0.0	0.0
North Bay Aqueduct	100.0	100.0	0.0	0.0
South Bay Aqueduct				
Del Valle Dam and Lake Del Valle	25.2	22.0	74.8 <sup>b</sup>	78.0 <sup>c</sup>
Remainder of South Bay Aqueduct	100.0	100.0	0.0	0.0
California Aqueduct				
Delta to Dos Amigos Pumping Plant	96.6	96.7	3.4	3.3
Dos Amigos Pumping Plant to termini (excluding Coastal Branch)	94.3	96.9	5.7	3.1
Coastal Branch	100.0	100.0	0.0	0.0

<sup>a</sup>Percentages indicated are applicable to the remaining costs of division after excluding costs allocated to flood control that are reimbursed by the federal government (22 percent of capital costs) and excluding specific power costs of Hyatt and Thermalito Powerplants and switchyards.

<sup>b</sup>Percentage indicated consists of 48.0 percent of costs allocated to recreation and 26.8 percent to flood control.

<sup>c</sup>Percentage indicated consists of 44.9 percent of costs allocated to recreation and 33.1 percent to flood control.

Pumping Plant (a joint Transportation-Conservation Facility) that are allocated to the conveyance of annual conservation water quantities are transferred to the capital costs of San Luis Reservoir (during initial fill) or to the minimum OMP&R costs of San Luis Reservoir (subsequent to initial fill).

In years of net storage withdrawal from San Luis Reservoir, a portion of the minimum OMP&R cost of the reservoir is transferred to the variable OMP&R cost of Banks Pumping Plant. That transfer is equal to the variable OMP&R cost per acre-foot of delivery through Banks Pumping Plant for that year, multiplied by the acre-feet of deliveries derived from San Luis Reservoir storage for that year. Table B-6 also includes amounts of nonproject water and surplus water delivered prior to May 1, 1973, and actual deliveries of interruptible water in 1994 and after.

## Bases for Reimbursable Costs

This section describes the methods used to derive the costs allocated by the procedures outlined in the preceding section. A diagram of the cost derivation process is shown in the upper-left quadrant of Figure B-1.

First, the capital and minimum OMP&R costs of all SWP facilities are allocated among the various project purposes according to the allocation percentages in Table 2. Those percentages may be subject to revision in the future.

The redeterminations in this appendix involve only the SWP costs that are allocated to water supply and power generation.

## Capital Costs

Capital costs used in the redeterminations in this appendix reflect prices prevailing on December 31, 2007; future cost escalation will be reflected in subsequent bulletins.

*Table B-7* presents a reconciliation of estimated total capital costs of each Project Conservation Facility and each Project Transportation Facility. This table shows the relationship of Project Conservation and Transportation costs allocated to contractors (Tables B-8, B-9, B-10, and B-13) to the total SWP capital costs projected by DWR.

*Table B-8* shows costs incurred and projected to be incurred by the State in connection with each contractor's turnouts. Costs incurred by the State for both State-constructed and contractor-constructed delivery structures are paid directly by the contractors for which the structures are built. (The State incurs design review and construction inspection costs in connection with contractor-constructed turnouts.)

*Table B-9* lists costs and payments for excess capacity built into SWP Transportation Facilities according to amendments to contracts with Metropolitan Water District of Southern California, San Gabriel Valley Municipal Water District, and AVEK, these include:

- additional costs incurred by the State for requested excess capacity;
- advances by water contractors of funds for such costs; and
- credits for advances in excess of costs, which were applied to respective contractors' installments of the capital cost component of the Transportation Charge in 1981.



Under Amendment 2 of Metropolitan's contract, 809 cubic feet per second of excess capacity was originally constructed in reaches of the West Branch at Metropolitan's request. That capacity was reclassified as basic capacity of SWP Transportation Facilities under Amendment 7. Metropolitan paid \$16.3 million as a prepayment of the capital cost component of the Transportation Charge in lieu of advancing funds for the original requested capacity.

Amendment 5 to Metropolitan's contract requires that additional costs for modifications to the Santa Ana Pipeline (required for enlargement of Lake Perris) will be allocated to Metropolitan and returned to the State through payments of the Transportation Charge. The additional costs to be repaid through Metropolitan's capital cost component for the aqueduct reach from Devil Canyon Powerplant to Barton Road total about \$6.7 million (see Bulletin 132-72, page 98).

*Table B-10* presents the actual and projected annual capital costs of each aqueduct reach that will eventually be returned to the State, with interest, through contractors' payments of the capital cost component of the Transportation Charge and payment of debt service under the Devil Canyon-Castaic contracts.

### **Annual Operating Costs**

Annual operating costs allocable to water supply and power generation are returned to the State through the minimum and variable OMP&R components of the Delta Water Charge and the Transportation Charge and through a portion of the revenues from energy sales. All reimbursable operating costs of

Conservation Facilities are included in the minimum OMP&R component of the Delta Water Charge.

### **Transportation and Devil Canyon-Castaic Contract Costs**

*Table B-11* shows the amounts of the actual and projected costs to be reimbursed through payments of the minimum OMP&R component of the Transportation Charge and allocated operating costs under the Devil Canyon-Castaic contract. The table includes the following seven types of operating costs incurred annually that do not vary with water quantities delivered to the contractors:

- 1) all direct labor charges for field operation and maintenance personnel, including associated indirect costs;
- 2) a distributed share of general operating costs that cannot be identified solely with one facility or aqueduct reach;
- 3) all of electric power transmission and station service costs up to 2004, and electric power transmission and station service costs for 2005 and after that do not vary with power usage allocable to aqueduct pumping and recovery plants;
- 4) all costs for equipment, materials, and supplies;
- 5) portions of the power and replacement costs of all up-aqueduct pumping plants and power plants that are allocable to the annual conveyance of water lost to evaporation and seepage from respective aqueduct reaches or placed into storage in respective reservoirs of the project transportation facilities (after initial fill);
- 6) credits, which offset those costs in (5) above, for deliveries drawn from

reservoir storage; and

- 7) escalation of projected operating costs at five percent per year for 2008, 2009, and 2010.

*Table B-12* shows the portions of variable OMP&R costs in *Table B-3* that are allocable to the water supply delivery quantities included in *Table B-6* and reimbursed through payments of the variable OMP&R component of the Transportation Charge.

The following adjustments are made to *Table B-3* costs to derive *Table B-12* costs:

- 1) Part of the variable OMP&R costs of each plant is allocated to recreation. The allocation to recreation is in proportion to the quantity of water conveyed through each plant each year for delivery to on-shore recreational developments. That portion of variable plant costs attributable to the initial fill of aqueduct reaches is allocated to the joint capital costs of respective down-aqueduct reaches and reservoirs.
- 2) That portion of costs attributable to evaporation and seepage is allocated to the joint minimum OMP&R costs of respective down-aqueduct reaches and reservoirs.
- 3) Adjustments are made for additions or withdrawals from storage in aqueduct reservoirs. In years when water is added to storage in aqueduct reservoirs, the cost of conveying this water into storage is charged to the minimum OMP&R costs of the corresponding reservoir. In years when storage in aqueduct reservoirs is decreased for the purpose of making deliveries, a credit is applied to the minimum OMP&R costs of the reservoir from which the storage

is released. This credit is equal to the number of acre-feet of storage reduction times the variable OMP&R unit rate for the year storage is released. The unit rate is equal to the variable OMP&R unit rate for the year the water is taken from storage.

- 4) That portion of costs attributable to pumping water to replace evaporation and seepage losses and for additions or withdrawals from storage in San Luis Reservoir is charged to the minimum OMP&R component of the Delta Water Rate.

The remaining costs are allocated to transportation water supply and repaid by the contractors.

### **Conservation Capital and Operating Costs**

*Table B-13* is a summary of actual and projected capital and operating costs of the initial Project Conservation Facilities. These costs are reimbursed through payments by contractors under the Delta Water Charge, Oroville power sales, and Gianelli Generating Plant credits. *Table B-13* also shows credits applied to the reimbursable capital costs of the Project Conservation Facilities according to negotiated settlements concerning incurred planning costs for the period from 1952 through 1978.

DWR is currently negotiating two new conservation programs to address on-going issues at the Delta, the Delta Habitat, Conveyance and Conservation Plan and a new Four Pumps Agreement. Program costs estimates were included as part of the Conservation costs. These costs and associated allocations will be adjusted

in future bills to reflect contractual agreements and agency participation.

## Project Water Charges

This section describes the redetermination of past and projected components of the Transportation Charge for annual revision of Tables C through G of each water supply contract. This section also describes the derivation of the unit Delta Water Rates and the Water System Revenue Bond Surcharge.

A summary of equivalent unit charges for each acre-foot of allocated water service is also included for each contractor and each aqueduct reach. A diagram of all calculations may be found in the lower half of Figure B-1.

## Transportation Charges

The accumulation of allocated costs of each aqueduct reach to each contractor is the basis for the Transportation Charge components.

*Table B-14* summarizes each contractor's share of the capital costs of aqueduct reaches presented in Table B-10. Those amounts are determined by applying proportionate-use ratios set forth in Table B-1 to the costs in Table B-10. The resulting allocated costs are set forth in Table C of the respective water supply contracts.

Prepayments of the capital cost component, required under Metropolitan's Amendment 7, are included as negative capital costs in Table B-14 and Table C of Metropolitan's Statement of Charges. Solano, Empire-West Side Irrigation District, and Castaic Lake Water Agency

also prepaid capital costs (see Table B-14 footnotes). Table B-14 includes costs of the planned East Branch Extension to provide water service to San Bernardino Valley Municipal Water District and San Geronio Pass Water Agency.

Both Table B-14 and Table C of the six contractors for project water service below Devil Canyon Powerplant and Castaic Powerplant include the capital costs reimbursable under the Devil Canyon-Castaic contract.

Table B-15 summarizes capital cost components of the Transportation Charge for each contractor for each year of the project repayment period. By the year 2035, the capital cost components shown in Table B-15 will recover the costs shown in Table B-14, with interest at the Project Interest Rate of 4.608 percent per annum and based on the amortization schedules included in Table 3.

Those estimated components, subsequently adjusted for prior overpayments or underpayments, are included in Table D of the water supply contracts. Costs of excess capacity are billed separately and are not included in Table B-15.

*Table B-15* includes the debt service payments due from the six contractors down-aqueduct from Devil Canyon Powerplant and Castaic Powerplant according to terms of the Devil Canyon-Castaic contract.

*Table B-16A* summarizes the minimum OMP&R components of the Transportation Charge for each year of the project repayment period. Those estimated

**Table 3. Criteria for Amortizing Capital Costs of Transportation Facilities**

Contractor	Year of Initial Payment <sup>a</sup>
Alameda County Flood Control and Water Conservation District – Zone 7	1963 <sup>b</sup>
Alameda County Water District	1963
Antelope Valley—East Kern Water Agency	1963
Castaic Lake Water Agency	1964
City Yuba City	c
Coachella Valley Water District	1964
County of Butte	c
County of Kings	1968
Crestline-Lake Arrowhead Water Agency	1964
Desert Water Agency	1963 <sup>d</sup>
Dudley Ridge Water District	1968 <sup>e</sup>
Kern County Water Agency	
Agricultural Use	1968 <sup>e</sup>
Municipal and Industrial Use	1968 <sup>e</sup>
Little Rock Creek Irrigation District	1964
Metropolitan Water District of Southern California	1963
Mojave Water Agency	1964
Napa County Flood Control and Water Conservation District	1966
Oak Flat Water District	1968
Palmdale Water District	1964
Plumas County Flood Control and Water Conservation District	1970
San Bernadino Valley Municipal Water District	1963
San Gabriel Valley Municipal Water District	1963 <sup>d</sup>
San Geronio Pass Water Agency	1963 <sup>d</sup>
San Luis Obispo County Flood Control and Water Conservation District	1964 <sup>f</sup>
Santa Barbara County Flood Control and Water Conservation District	1964
Santa Clara Valley Water District	1963
Solano County Water Agency	1973
Tulare Lake Basin Water Storage District	1968 <sup>e</sup>
Ventura County Watershed Protection District	1964

<sup>a</sup> Allocated capital costs of transportation facilities amortized in equal annual installments unless otherwise noted.

<sup>b</sup> Principal payments on each annual capital cost prior to 1971 delayed until calendar year 1972, except payments for 1963.

<sup>c</sup> For Yuba City and Butte County payments for Delta Water Charge only.

<sup>d</sup> Payment deferred for 1963 and added to 1964 payment with accrued interest.

<sup>e</sup> For Dudley Ridge, Empire, Kern (agricultural use), Oak Flat, and Tulare, according to Article 45 of the contracts for supply of agricultural water, capital costs of transportation facilities allocated to agricultural water supply are amortized by using an equivalent unit rate per acre-foot applied to the annual allocations (Table B-4) through the project repayment period.

<sup>f</sup> For San Luis Obispo and Santa Barbara County, all principal and interest payments for costs of the Coastal Stub were deferred until 1976.

**Table 4. Minimum OMP&R Costs of Reach 31A Assigned Directly to Kern County Water Agency**

Year	Direct Charges
1969	46,511
1970	46,302
1971	140,074
1972	95,017
1973	72,454
1974	100,692
1975	127,456
1976	138,504
1977	120,753
1978	157,652
1979	121,231
1980	150,728
1981	75,866
1982	82,805
1983	90,007
1984	107,468
1985	159,406
1986	137,241
1987	127,073
1988	130,924
1989	128,468
1990	138,234
1991	139,527
1992	185,370
1993	219,334
1994	364,196
1995	272,341
1996	322,123
<b>Total</b>	<b>3,997,767</b>

components, subsequently adjusted for prior overpayments or underpayments, are included in Table E of the respective contracts.

The total amounts included in Table B-16A are determined by applying the proportionate-use ratios in Table B-2 to the reach costs in Table B-11.

*Table B-16A* excludes Off-Aqueduct Power Facility charges, which are included separately in Table B-16B. Both Table B-16A and Table E include the operating costs payable under the Devil Canyon-Castaic contract for the six contractors down-aqueduct from Devil Canyon Powerplant and Castaic Powerplant.

As part of operating agreements with DWR, Kern was billed from 1963 through 1987 for any additional operating costs caused by early installation of units in Las Perillas and Badger Hill Pumping Plants by Berrenda Mesa Water Storage District (see Bulletin 132-71, page 7). Under those agreements, a portion of minimum OMP&R costs of Reach 31A were assigned directly to Kern, as shown in Table 4, with the remaining reach costs allocated by application of the proportionate-use ratios. DWR purchased the last unit, Unit No. 6, at Las Perillas and Badger Hill Pumping Plants in early 1997 to provide pumping capacity for deliveries to Coastal Area contractors, which began in 1997. As a result of the Monterey Amendment, the costs related to this settlement are to be allocated among all SWP contractors in proportion to their maximum Table A amounts. As costs are incurred, related charges will be included in the contractors' annual Statements of Charges as part of the minimum. It is estimated that between 2002 and 2010, the Monterey Amendment

litigation costs will be slightly less than \$16 million.

*Table B16-B* summarizes annual Off-Aqueduct Power Facility charges allocated to each water contractor, adjusted for prior overpayments or underpayments. Those charges are to repay all Off-Aqueduct Power costs, including bond service, deposits for reserves, operation and maintenance costs, fuel costs, taxes, and insurance.

Adopted October 1, 1979, the General Bond Resolution requires that sufficient revenues be collected each year to repay all of those costs. In addition, an amount totaling 25 percent of the annual bond service is collected each year to ensure that sufficient funds are available to cover all annual costs. Any revenues collected and not needed during the year are refunded to the contractors in the next year.

Table 5 summarizes Off-Aqueduct Power Facility charges and credits related to deliveries for 2007.

**Table 5. Summary of 2007 Off-Aqueduct Power Facility Charges and Credits**

Charges by Item	(Dollars)
Reid Gardner Powerplant	87,418,129
Bottle Rock Powerplant	14,282,125
South Geysers Powerplant	6,723,098
<i>Subtotal</i>	<i>108,423,352</i>
<b>Credits by Item</b>	
Power Sales	(16,581,848)
<b>Net Total Charge</b>	<b>91,841,504</b>

Table 6 shows projected Off-Aqueduct Power Facility charges and an amount equal to 25 percent of annual bond service for 2008 through 2029.

Annual Off-Aqueduct Power Facility charges are allocated among contractors in proportion to the electrical energy required to pump allocated water for the year. The initial allocation for the Statements of Charges is based on estimates of energy to pump requested allocated water deliveries.

An interim adjustment in the allocation of Off-Aqueduct Power costs may be made in May of each year based on updated cost estimates and April revisions in water delivery schedules. An additional adjustment is made the following year based on actual water deliveries and actual costs for the year.

**Table 6. Projected Charges for Off-Aqueduct Power Facilities**

Year	Total Annual Cost (Dollars)	25% Bond Cover (Dollars)
2008	135,723,268	11,655,732
2009	142,090,852	12,910,026
2010	144,154,294	13,075,808
2011	141,010,556	12,451,292
2012	141,221,100	12,493,400
2013	78,250,003	6,428,385
2014	20,072,007	3,989,672
2015	11,892,459	2,353,762
2016	10,187,066	2,012,684
2017	9,785,391	1,932,349
2018	4,070,567	789,384
2019	4,050,878	785,446
2020	4,355,523	846,375
2021	6,714,690	1,318,208
2022	6,372,870	1,249,844
2023	4,538,351	882,941
2024	3,311,241	637,519
2025	335,289	66,588
2026	481,211	95,772
2027	813,726	162,275
2028	504,350	100,400
2029	497,350	99,000

The energy required to pump each contractor's water is calculated using the kilowatt-hour per acre-foot factors (shown in Table 7) for the pumping plants upstream from the delivery turnouts. The amounts include transmission losses.

**Table 7. Kilowatt-Hour per Acre-Foot Factors for Allocating Off-Aqueduct Power Facility Costs**

Pumping Plant	kWh per acre-foot <sup>a</sup>	
	At Plant	Cumulative from Delta
Barker Slough	223	223
Cordelia-Benicia	434	657
Cordelia-Vallejo	178	401
Cordelia-Napa	563	786
Banks	296	296
South Bay (including Del Valle)	869	1,165
Dos Amigos	138	434
Buena Vista	242	676
Teerink	295	971
Chrisman	639	1,610
Edmonston	2,236	3,846
Pearblossom	703	4,549
Greenspot	871	5,420
Crafton Hills	1,087	6,507
Cherry Valley	224	6,731
Oso	280	4,126
Las Perillas	77	511
Badger Hill	200	711
Devil's Den	705	1,416
Bluestone	705	2,121
Polonio Pass	705	2,826

<sup>a</sup>Includes transmission losses.

Table B-17 presents a summary of actual and projected total variable OMP&R costs for each acre-foot of water conveyed through each aqueduct pumping plant and power plant for each year of the project. Provisions for calculating the variable OMP&R component of the Transportation Charge:

- An annual charge per acre-foot of projected water deliveries to all contractors served from or through

each reach is determined so the projected variable OMP&R costs to be incurred for each reach will be returned to the State.

- The total annual variable OMP&R component for any contractor for a given reach is obtained by multiplying the unit charge associated with that reach by the quantity of water actually delivered from or through the reach to the contractor.

The data summarized in Table B-17 are derived by dividing the costs shown in Table B-3 by the quantities of water shown in Table B-6. However, certain costs included in Table B-3 for extra peaking service, which would otherwise constitute variable OMP&R costs, are assigned directly to contractors requesting this type of service (see Bulletin 132-71, page 21, and Water Service Contractors Council Memo No. 593, July 10, 1970). Those costs are excluded from the unit charges shown in Table B-17. Peaking charges based on additional capacity ceased in 1983. Since 1984, costs are based on market energy rates. The amounts of extra peaking charges for additional power costs are shown in Tables 8 and 9 on pages B-22 and B-23.

The unit rates shown in Table B-17 constitute the rates for the pumping plants and power plants listed. The cumulative rates constitute the total rates, cumulative from the Sacramento-San Joaquin Delta, and are applicable to deliveries from or downstream of the pumping plants and power plants. Extra peaking service costs are excluded.

Table B-18 shows the variable OMP&R components of the Transportation Charge for each contractor for each year of the

**Table 8. Extra Peaking Charges for Additional Power, by Pumping Plant (Dollars)**

Year	Las Perillas and Badger Hill											Total			
	Cordelia Napa	Cordelia Solano	Barker Slough	South Bay	Banks	Dos Amigos	Badger Hill	Buena Vista	Teerink	Chrisman	Edmonston		Pearblossom	Oso	
1972	0	0	0	0	0	10,579	24,700	0	0	0	0	0	0	0	35,279
1973	0	0	0	0	0	0	6,016	0	0	0	0	0	0	0	6,016
1974	0	0	0	0	0	0	7,140	0	0	0	0	0	0	0	7,140
1975	0	0	0	0	0	494	6,397	0	0	0	0	0	0	0	6,891
1976	0	0	0	0	0	0	1,981	0	0	0	0	0	0	0	1,981
1977	0	0	0	0	0	0	0	0	0	0	0	0	0	0	0
1978	0	0	0	0	0	45,145	3,680	0	0	0	0	0	0	0	48,825
1979	0	0	0	0	0	0	3,306	0	0	0	0	0	0	0	3,306
1980	0	0	0	0	0	0	0	0	0	0	0	0	0	0	0
1981	0	0	0	0	0	12,126	0	0	0	0	0	0	0	0	12,126
1982	0	0	0	0	0	89,339	0	0	0	0	0	0	0	0	89,339
1983	0	0	0	35	7,594	3,534	152	0	0	0	0	0	0	0	11,315
1984	0	0	0	2,096	84,396	38,607	7,203	11,173	3,823	3,593	0	0	0	0	150,891
1985	0	0	0	1,480	19,612	8,841	763	4,488	4,412	8,929	28,353	0	0	0	76,878
1986	0	0	0	0	1,864	863	0	291	354	766	2,683	0	0	0	6,821
1987	0	0	0	604	17,129	7,838	835	2,295	1,806	3,460	11,058	0	0	0	45,025
1988	639	39	287	894	43,475	20,082	2,213	5,792	4,367	8,272	25,886	0	0	0	111,946
1989	2,491	566	1,483	70	40,251	18,642	1,935	3,401	1,531	2,058	3,793	0	0	0	76,221
1990	45	0	18	343	19,524	9,044	0	150	145	314	643	0	0	0	30,226
1991	903	0	281	0	21	8	0	15	17	39	139	41	0	0	1,464
1992	208	117	203	0	7,070	2,502	0	182	190	435	0	0	0	0	10,907
1993	0	681	889	4,483	123,080	54,741	0	8,898	5,458	10,900	35,068	11,139	0	0	255,337
1994	0	366	393	679	6,566	2,795	454	1,083	155	357	1,121	0	132	0	14,101
1995	0	0	0	1,717	24,464	9,422	27	1,865	3,475	782	1,104	400	0	0	43,256
1996	4	0	1	1,983	10,031	4,976	0	391	432	1,015	3,404	1,160	0	0	23,397
1997	0	1,780	2,152	3,107	337,357	165,774	1,753	34,604	12,296	15,910	21,028	0	0	0	595,761
1998	0	0	0	20,966	235,693	106,251	2,354	697	848	1,836	6,426	0	0	0	375,071
1999	0	0	0	0	63,196	26,235	0	3,394	4,136	8,959	31,350	7,740	0	0	145,010
2000	0	0	0	0	0	0	0	0	0	0	0	0	0	0	0
2001	0	0	0	0	0	0	0	0	0	0	0	0	0	0	0
2002	0	0	0	0	0	0	0	0	0	0	0	0	0	0	0
2003	0	0	0	0	0	0	0	0	0	0	0	0	0	0	0
2004	0	0	0	0	0	0	0	0	0	0	0	0	0	0	0
2005	0	0	0	0	0	0	0	0	0	0	0	0	0	0	0
2006	0	0	0	0	0	0	0	0	0	0	0	0	0	0	0
2007	0	0	0	0	0	0	0	0	0	0	0	0	0	0	0
<b>Total</b>	<b>4,290</b>	<b>3,549</b>	<b>5,707</b>	<b>38,457</b>	<b>1,041,323</b>	<b>637,838</b>	<b>70,909</b>	<b>78,719</b>	<b>43,445</b>	<b>67,625</b>	<b>172,056</b>	<b>20,480</b>	<b>132</b>	<b>0</b>	<b>2,184,530</b>



**Table 9. Extra Peaking Charges for Additional Power, by Contractor (Dollars)**

Year	Napa	Solano	Alameda Zone7	Alameda County	Santa Clara	Dudley Ridge	Empire	Kern	Kings	Oak Flat	Tulare	AVEK	Castaic Lake	Coachella	Desert	Littlerock	Palmdale	San Gabriel	Total
1972	0	0	0	0	0	0	0	35,269	0	0	10	0	0	0	0	0	0	0	35,279
1973	0	0	0	0	0	0	0	6,016	0	0	0	0	0	0	0	0	0	0	6,016
1974	0	0	0	0	0	0	0	7,140	0	0	0	0	0	0	0	0	0	0	7,140
1975	0	0	0	0	0	0	0	6,891	0	0	0	0	0	0	0	0	0	0	6,891
1976	0	0	0	0	0	0	0	1,981	0	0	0	0	0	0	0	0	0	0	1,981
1977	0	0	0	0	0	0	0	0	0	0	0	0	0	0	0	0	0	0	0
1978	0	0	0	0	0	2,035	0	44,484	42	0	0	2,264	0	0	0	0	0	0	48,825
1979	0	0	0	0	0	0	0	2,821	0	0	0	0	485	0	0	0	0	0	3,306
1980	0	0	0	0	0	0	0	0	0	0	0	0	0	0	0	0	0	0	0
1981	0	0	0	0	0	0	0	11,951	0	0	0	0	0	0	0	175	0	0	12,126
1982	0	0	0	0	0	2,173	0	80,945	0	0	0	4,671	1,128	0	0	0	0	422	89,339
1983	0	0	0	0	48	9,511	0	0	1,365	0	0	0	391	0	0	0	0	0	11,315
1984	0	0	0	0	2,874	0	0	144,021	281	809	0	0	2,906	0	0	0	0	0	150,891
1985	0	0	0	2,029	0	0	64	25,664	0	98	0	48,767	256	0	0	0	0	0	76,878
1986	0	0	0	0	0	0	0	0	0	13	2,194	4,614	0	0	0	0	0	0	6,821
1987	0	0	229	0	599	313	84	24,141	0	95	0	18,207	545	0	0	812	0	0	45,025
1988	892	73	665	561	0	1,853	1,404	58,905	0	72	2,368	44,526	627	0	0	0	0	0	111,946
1989	3,478	1,062	96	0	0	13	403	55,085	0	239	8,278	0	1,043	0	0	1,035	5,489	0	76,221
1990	63	0	470	0	0	0	0	28,587	0	0	0	0	0	0	0	81	1,025	0	30,226
1991	1,184	0	0	0	0	0	0	0	0	0	0	0	0	0	0	280	0	0	1,464
1992	271	257	0	0	0	0	49	10,109	221	0	0	0	0	0	0	0	0	0	10,907
1993	0	1,570	6,122	0	0	0	3,757	97,812	504	0	74,577	0	0	24,983	41,156	0	4,856	0	255,337
1994	0	759	896	0	0	0	7	9,933	0	0	0	0	2,450	0	0	56	0	0	14,101
1995	0	0	2,353	0	0	10,197	0	28,085	310	0	0	0	27	0	0	0	2,284	0	43,256
1996	5	0	81	2,612	0	334	205	4,552	969	0	7,809	0	0	0	0	0	3,598	3,232	23,397
1997	0	3,932	3,999	0	0	6,190	0	546,733	0	40	0	0	0	0	0	0	34,867	0	595,761
1998	0	0	19,666	8,442	0	22,631	1	312,626	0	651	0	0	0	0	0	0	11,054	0	375,071
1999	0	0	0	0	0	0	0	76,425	0	0	6,922	0	0	0	0	0	11,576	50,087	145,010
2000	0	0	0	0	0	0	0	0	0	0	0	0	0	0	0	0	0	0	0
2001	0	0	0	0	0	0	0	0	0	0	0	0	0	0	0	0	0	0	0
2002	0	0	0	0	0	0	0	0	0	0	0	0	0	0	0	0	0	0	0
2003	0	0	0	0	0	0	0	0	0	0	0	0	0	0	0	0	0	0	0
2004	0	0	0	0	0	0	0	0	0	0	0	0	0	0	0	0	0	0	0
2005	0	0	0	0	0	0	0	0	0	0	0	0	0	0	0	0	0	0	0
2006	0	0	0	0	0	0	0	0	0	0	0	0	0	0	0	0	0	0	0
2007	0	0	0	0	0	0	0	0	0	0	0	0	0	0	0	0	0	0	0
<b>Total</b>	<b>5,893</b>	<b>7,653</b>	<b>34,577</b>	<b>13,644</b>	<b>3,521</b>	<b>55,250</b>	<b>5,974</b>	<b>1,620,176</b>	<b>3,692</b>	<b>2,017</b>	<b>102,158</b>	<b>123,049</b>	<b>9,858</b>	<b>24,983</b>	<b>41,156</b>	<b>2,439</b>	<b>74,749</b>	<b>53,741</b>	<b>2,184,530</b>

project repayment period. Table B-18 is developed from the costs per acre-foot included in Table B-17 and the delivery quantities for each contractor from each reach as indicated in Table B-5A, plus any costs for extra peaking service. Those estimated components, subsequently adjusted for prior overpayments or underpayments, are included in Table F of the respective water supply contracts.

*Table B-19* summarizes the annual Transportation Charges for each contractor (the sums of the corresponding amounts included in Tables B-15, B-16A, B-16B, and B-18). Those estimated payments, subsequently adjusted for prior overpayments or underpayments, are set forth in Table G of the respective water supply contracts.

According to provisions of the Devil Canyon-Castaic contract, Table B-19 and Table G include amounts of debt service and operating cost payments due from the six contractors located down-aqueduct from Devil Canyon and Castaic Powerplants.

### **Delta Water Charges**

*Table B-20A* presents the calculation of the Delta Water Rate for the initial Conservation Facilities applicable in 2009 according to the amended Article 22(e) and 22(g) of all 29 contracts. The Delta Water Rate was calculated at a Project Interest Rate of 4.608 percent based on Conservation Facility costs shown in Table B-13. That Delta Water Rate is used to compute projected Delta Water Charges under Article 53(i) for the contractors who have executed the Monterey Amendment. Included in Table B-20A is the Delta Water Rate for the two contractors who have

not executed the Monterey Amendment (Plumas County and Empire).

Table B-20B shows each component of the 2009 Delta Water Rate from Table B-20A.

*Table B-21* summarizes the annual Delta Water Charge for each contractor. The projected charges in Table B-21 are developed by multiplying the total rate per acre-foot, as shown in Table B-20A, by the amount of allocated water for each contractor as shown in Table B-4.

### **Water System Revenue Bond Surcharge**

*Table B-22* summarizes the Water System Revenue Bond Surcharge (WSRB) to the Delta Water Charge and the transportation capital cost component for each contractor. The surcharge shown in Table B-22 includes the financing costs of the WSRB surcharge, series B through AE. This surcharge is levied according to an amendment to the water supply contracts, which was signed by all long-term water supply contractors.

### **Total Water Charges**

*Table B-23* summarizes the total annual charges to each contractor (the sum of the Transportation Charge in Table B-19, the Delta Water Charge in Table B-21, and the Water System Revenue Bond Surcharge in Table B-22). The charges do not reflect past payments by contractors and are unadjusted for prior overpayments or underpayments.

### **Equivalent Total Water Charges**

*Table B-24* presents the Transportation Charge and Delta Water Charge in terms of

the equivalent unit charge for each acre-foot of allocated water now projected for delivery to the respective contractors.

These equivalent charges would provide the same principal sum at the end of the project repayment period as annual payments to be made as part of the Delta Water Charge and Transportation Charge, plus interest at the Project Interest Rate, if applied to each acre-foot of allocated water delivered to date; all surplus water delivered prior to May 1, 1973; all interruptible water deliveries in 1994 and after; and all allocated water now projected to be delivered during the remainder of the project repayment period (Table B-5B).

The equivalent unit Delta Water Charges included in Table B-24 are greater than those in Table B-20A because current projections of allocated water service are less for most contractors than the amounts shown in Table A.

### **Equivalent Water Costs by Reach**

*Table B-25* presents a summary of the equivalent unit transportation cost of conveying allocated water through respective aqueduct reaches of the Project Transportation Facilities.

Those unit costs provide the basis of charges assessed for extra service (such as delivery of allocations down-aqueduct from a contractor's turnout) and for wheeling service to entities other than the long-term water supply contractors.

The cumulative unit conveyance costs indicated for reaches in Table B-25 do not necessarily equal the equivalent unit Transportation Charges to contractors

served from such reaches. The unit charges in Table B-24 account for the rate of water demand buildup and cost allocation factors of the individual contractors; however, the unit costs included in Table B-25 reflect the effect of melding the respective buildups and allocation criteria of all contractors whose allocations are conveyed through a given reach. Table B-25 also includes surplus water delivered prior to May 1, 1973, and interruptible water deliveries in 1994 and after.

### **East Branch Enlargement Facility Charges**

*Table B-26* reflects DWR's projection of annual capital costs of the East Branch Enlargement Facilities for each aqueduct reach. These projections will be redetermined in future bulletins to include:

- a reallocation of costs of constructing the present east branch facilities between Alamo Powerplant and Silverwood Lake;
- a reallocation of costs of Silverwood Lake to reflect additional use as a result of East Branch Enlargement operation;
- a reallocation of costs of San Bernardino Tunnel to reflect redistribution of flow capacities necessary for the East Branch Enlargement facilities; and
- actual construction costs of the enlargement.

These costs will be recovered with interest from the seven Southern California water contractors participating in the enlargement, according to their amended water supply contracts (see Table 10).

**Table 10. Determination of Factors for Distributing Capital and Minimum OMP&R Costs of East Branch Enlargement Facilities among Participating Contractors**

Reach Number	Description							
18A	Junction, West Branch, California Aqueduct, through Alamo Powerplant							
19	Alamo Powerplant to Fairmont							
20A	Fairmont through 70th Street West							
20B	70th Street West to Palmdale							
21	Palmdale to Littlerock Creek							
22A	Littlerock Creek to Pearblossom Pumping Plant							
22B	Pearblossom Pumping Plant to West Fork Mojave River							
23B	West Fork Mojave River to Silverwood Lake (excluding Mojave Siphon Powerplant facilities)							
23C	Mojave Siphon Powerplant facilities							
24	Cedar Springs Dam and Silverwood Lake							
25	Silverwood Lake to South Portal, San Bernardino Tunnel							
26A	South Portal, San Bernardino Tunnel through Devil Canyon Powerplant							
26B	Devil Canyon Powerplant Bypass							

Share of Enlargement Capacity (cfs)									
Reach Number	Antelope Valley-East Kern Water Agency	Coachella Valley Water District	Desert Water Agency	Mojave Water Agency	Palmdale Water District	San Bernardino Valley Municipal Water District	Metropolitan Water District of Southern California	Total	
18A		151	13	136	6		1,200	1,506	
19		151	13	136	6		1,200	1,506	
20A	35	151	13	136	6		1,200	1,541	
20B	35	151	13	136	6		1,200	1,541	
21	35	151	13	136			1,200	1,535	
22A	35	151	13	136			1,200	1,535	
22B		151	13	136			1,200	1,500	
23B		184	67	212			1,200	1,663	
23C		184	67				1,200	1,451	
24		190	78				1,200	1,468	
25		193	83			63	1,200	1,539	
26A		193	83			63	1,200	1,539	
26B							300	300	

Factors for Distributing Capital and Minimum OMP&R Costs of East Branch Enlargement Facilities (flow ratios)									
Reach Number	Antelope Valley-East Kern Water Agency	Coachella Valley Water District	Desert Water Agency	Mojave Water Agency	Palmdale Water District	San Bernardino Valley Municipal Water District	Metropolitan Water District of Southern California	Total	
18A	0.00000000	0.10026560	0.00863214	0.09030544	0.00398406	0.00000000	0.79681276	1.00000000	
19	0.00000000	0.10026560	0.00863214	0.09030544	0.00398406	0.00000000	0.79681276	1.00000000	
20A	0.02271252	0.09798832	0.00843608	0.08825438	0.00398358	0.00000000	0.77871512	1.00000000	
20B	0.02271252	0.09798832	0.00843608	0.08825438	0.00398358	0.00000000	0.77871512	1.00000000	
21	0.02280130	0.09837134	0.00846906	0.08859935	0.00000000	0.00000000	0.78175895	1.00000000	
22A	0.02280130	0.09837134	0.00846906	0.08859935	0.00000000	0.00000000	0.78175895	1.00000000	
22B	0.00000000	0.10066667	0.00866667	0.09066667	0.00000000	0.00000000	0.79999999	1.00000000	
23B	0.00000000	0.11064342	0.04028863	0.12748046	0.00000000	0.00000000	0.72158749	1.00000000	
23C	0.00000000	0.12680910	0.04617505	0.00000000	0.00000000	0.00000000	0.82701585	1.00000000	
24	0.00000000	0.12942779	0.05313351	0.00000000	0.00000000	0.00000000	0.81743870	1.00000000	
25	0.00000000	0.12540611	0.05393112	0.00000000	0.00000000	0.04093567	0.77972710	1.00000000	
26A	0.00000000	0.12540611	0.05393112	0.00000000	0.00000000	0.04093567	0.77972710	1.00000000	
26B	0.00000000	0.00000000	0.00000000	0.00000000	0.00000000	0.00000000	1.00000000	1.00000000	

*Table B-27* lists the projected minimum OMP&R costs for each reach of the enlargement to be repaid by the seven contractors participating in the East Branch Enlargement. Currently, this table includes only minimum OMP&R costs attributable to the East Branch Enlargement. According to Article 49(e)(1), the contractors participating in the East Branch Enlargement will also share in the remaining minimum OMP&R costs of the affected reaches according to a formula developed by DWR in consultation with the affected contractors.

*Table B-28* shows each participating contractor's share of the estimated capital costs of the East Branch Enlargement shown in Table B-26.

*Table B-29* shows the amounts of the annual capital cost components of the East Branch Enlargement Transportation Charge for each participating contractor. This component consists of each contractor's allocated share of debt service on bonds sold to finance the enlargement.

*Table B-30* shows the minimum OMP&R components of the East Branch Enlargement Transportation Charge for each participating contractor for each year of the project repayment period. The amounts shown in Table B-30 will recover the minimum OMP&R costs shown in Table B-27.

*Table B-31* shows the annual East Branch Enlargement Transportation charges for each participating contractor (the sum of the corresponding amounts included in Tables B-29 and B-30).

## **East Branch Extension Phase I Facility Charges**

The East Branch Extension-Phase I charges recover associated costs for East Branch Extension facilities beginning at Devil Canyon Powerplant Afterbay and extending to the terminus at Noble Creek in the vicinity of Beaumont, Riverside County. These costs will be recovered from two contractors, San Bernardino and San Geronimo, according to their amended Water Supply contracts. The factors for distributing costs are shown in Table 11. Table 12 shows the debt service for 2009.

## **Short-Term Agreements**

DWR and the long-term water supply contractors execute short-term agreements that affect the contractors' charges. DWR executed a five-year agreement in 1997 with 16 municipal and industrial contractors who agreed to pay for allocated shares of Municipal Water Quality Investigations costs. In 2002 and 2006, additional amendments were executed to extend the program. The MWQI charges under this agreement are included in the transportation minimum OMP&R components shown in Table B-16A.

Nine contractors executed a short-term agreement (1997 and 1998) to participate in the feasibility study for the American Basin conjunctive-use program. Costs of the feasibility study are included in Table B-16A.

Contractors have agreed to participate in several Delta Improvement programs which started in 2007 and possibly extend out into the future.

The first contract pertains to the Bay Delta Conservation Plan (BDCP) agreed to in the Memorandum of Agreement for Supplemental Funding for Certain Ecosystem Actions and Support for Implementation of Near-Term Water Supply, Water Quality, Ecosystem, and Levee Actions (MOA). The BDCP is comprised of two elements, fishery costs and consultation costs. These costs were added to the contractors' transportation minimum component for bill years 2007 and 2008.

The second contract pertains to the non-BDCP costs of the MOA, which elements are Delta Vision and Pelagic Organism Decline research costs. These costs were added to the contractors' conservation minimum component for bill years 2007 and 2008.

**Table 11. Factors for Distributing Capital and Minimum OMP&R Costs of the East Branch Extension Facilities**

Reach Number	Reach Description	San Bernardino Municipal Water District	San Gorgonio Pass Water Agency	Total
<b>Capital</b>				
all	Average of the contractors' participation of EBX facilities	0.458417	0.541583	1.000000
<b>Minimum</b>				
1	Devil Canyon Powerplant to Junction, Foothill Pipeline near Cone Camp Road	0.557330	0.442670	1.000000
2A	Junction Foothill Pipeline near Cone Camp Rd to Greenspot Pump Station	0.557330	0.442670	1.000000
2B	Greenspot Pump Station to Morton Canyon Valve Vault	0.777778	0.222222	1.000000
2C	Morton Canyon Valve Vault to Crafton Hills Pump Station	0.777778	0.222222	1.000000
3A	Crafton Hills Pump Station to Carter Street Valve Vault	0.557330	0.442670	1.000000
3B	Carter Street Valve Vault to Garden Air Creek, South of San Bernardino County Line	0.557330	0.442670	1.000000
4A	Garden Air Creek to Cherry Valley Pump Station		1.000000	1.000000
4B	Cherry Valley Pump Station to Terminus at Noble Creek		1.000000	1.000000

**Table 12. East Branch Extension Facilities Debt Service for 2009**

Contractor	Share of Participation (%)	Total Debt Service Charge (Dollars)
San Bernardino	45.84170	8,032,839
San Gorgonio	54.15830	9,490,157
<b>Total</b>	100.00000	17,522,996

**Tables B-1 through B-3 Follow**

**TABLE B-1. Factors for Distributing Reach Capital Costs among Contractors**

Reach No.	Reach Description	NORTH BAY AREA		SOUTH BAY AREA				Total
		Napa County FC&WCD	Solano County WA	Alameda County FC&WCD, Zone 7	Alameda County Water District	Santa Clara Valley Water District	Future Contractor South Bay	
<b>NORTH BAY AQUEDUCT</b>								
1	Barker Slough thru Fairfield/Vacaville Turnout	0.29667896	0.70332104					1.00000000
2	Fairfield/Vacaville Turnout to Cordelia Forebay	0.38414552	0.61585448					1.00000000
3A	Cordelia Forebay thru Benicia and Vallejo Turnouts		1.00000000					1.00000000
3B	Cordelia Forebay thru Napa Turnout Reservoir	1.00000000						1.00000000
<b>SOUTH BAY AQUEDUCT</b>								
1	Bethany Reservoir thru Altamont Turnout			0.22599612	0.20663021	0.49237700	0.07499667	1.00000000
2	Altamont Turnout thru Patterson Reservoir			0.22599658	0.20663059	0.49237783	0.07499500	1.00000000
4	Patterson Reservoir to Del Valle Junction			0.19504795	0.21450017	0.51113249	0.07931939	1.00000000
5	Del Valle Junction thru Lake Del Valle			0.14436367	0.12972254	0.33715573	0.38875806	1.00000000
6	Del Valle Junction thru South Livermore Turnout			0.14599918	0.21144710	0.50574745	0.13680627	1.00000000
7	South Livermore Turnout thru Vallecitos Turnout				0.25176680	0.60218448	0.14604872	1.00000000
8	Vallecitos Turnout thru Alameda-Bayside Turnout				0.27934645	0.72065355		1.00000000
9	Alameda-Bayside Turnout thru Santa Clara Terminal Facilities					1.00000000		1.00000000
<b>CALIFORNIA AQUEDUCT</b>								
1	Delta thru Bethany Reservoir			0.00954737	0.00872917	0.02080118	0.00342507	N/A

Reach No.	Reach Description	CENTRAL COASTAL AREA		SOUTHERN CALIFORNIA AREA				
		San Luis Obispo County FC&WCD	Santa Barbara County FC&WCD	Antelope Valley-East Kern Water Agency	Castaic Lake Water Agency	Coachella Valley Water District	Crestline-Lake Arrowhead Water Agency	Desert Water Agency
<b>CALIFORNIA AQUEDUCT</b>								
1	Delta thru Bethany Reservoir	0.00533010	0.00983337	0.02939084	0.01285827	0.00528315	0.00133612	0.00871300
2A	Bethany Reservoir to Orestimba Creek	0.00557213	0.01027988	0.03072531	0.01343201	0.00552068	0.00139620	0.00910474
2B	Orestimba Creek to O'Neill Forebay	0.00557824	0.01029119	0.03075915	0.01345351	0.00552831	0.00139814	0.00911733
3	O'Neill Forebay to Dos Amigos Pumping Plant	0.00557719	0.01028923	0.03075332	0.01345294	0.00552772	0.00139798	0.00911637
4	Dos Amigos Pumping Plant to Panoche Creek	0.00557607	0.01028717	0.03074719	0.01345233	0.00552710	0.00139784	0.00911536
5	Panoche Creek to Five Points	0.00557467	0.01028462	0.03073954	0.01345157	0.00552633	0.00139763	0.00911409
6	Five Points to Arroyo Pasaiero	0.00557257	0.01028074	0.03072799	0.01345042	0.00552517	0.00139733	0.00911216
7	Arroyo Pasaiero to Kettleman City	0.00557189	0.01027949	0.03072428	0.01345006	0.00552480	0.00139723	0.00911154
8C	Kettleman City thru Milham Avenue	0.00557103	0.01027792	0.03071961	0.01344960	0.00552432	0.00139712	0.00911076
8D	Milham Avenue thru Avenal Gap	0.00568611	0.01049020	0.03135418	0.01373353	0.00563986	0.00142632	0.00930130
9	Avenal Gap thru Twisselman Road			0.03426625	0.01356094	0.00616886	0.00156011	0.01017373
10A	Twisselman Road thru Lost Hills			0.03481391	0.01377767	0.00626946	0.00158556	0.01033963
11B	Lost Hills to 7th Standard Road			0.03835043	0.01517717	0.00691699	0.00174933	0.01140749
12D	7th Standard Road thru Elk Hills Road			0.04031661	0.01595523	0.00727790	0.00184059	0.01202065
12E	Elk Hills Road thru Tupman Road			0.04037074	0.01597665	0.00728878	0.00184332	0.01202059
13B	Tupman Road to Buena Vista Pumping Plant			0.04379882	0.01733322	0.00791595	0.00200194	0.01305492
14A	Buena Vista Pumping Plant thru Santiago Creek			0.04599268	0.01820137	0.00831952	0.00210399	0.01372049
14B	Santiago Creek thru Old River Road			0.04682530	0.01853084	0.00847388	0.00214303	0.01397505
14C	Old River Road to Wheeler Ridge Pumping Plant			0.04825217	0.01909545	0.00873768	0.00220973	0.01441013
15A	Wheeler Ridge Pumping Plant to Chrisman Pumping Plant			0.04905609	0.01941356	0.00886879	0.00224744	0.01465600
16A	Chrisman Pumping Plant to Edmonston Pumping Plant			0.05089794	0.02014241	0.00922722	0.00233351	0.01521742
17E	Edmonston Pumping Plant to Porter Tunnel			0.05329388	0.02109050	0.00967107	0.00244575	0.01594937
17F	Porter Tunnel to Junction, West Branch, Calif. Aqueduct			0.05340725	0.02113537	0.00969176	0.00245098	0.01598349
18A	Junction, West Branch, Calif. Aqueduct thru Alamo Pwp.			0.13238112	0.02399391	0.00606795	0.00060679	0.03957043
19	Alamo Powerplant to Fairmont			0.13237766		0.02399451	0.00606811	0.03957141
19C	Buttes Junction thru Buttes Reservoir			1.00000000				
20A	Fairmont thru 70th Street West			0.06847931		0.02576425	0.00651573	0.04249001
20B	70th Street West to Palmdale			0.02276024		0.02702917	0.00683555	0.04457607
21	Palmdale to Littlerock Creek			0.02318952		0.02754716	0.00696651	0.04543034
22A	Littlerock Creek to Pearblossom Pumping Plant			0.01181870		0.02794143	0.00706621	0.04608043
22B	Pearblossom Pumping Plant to West Fork Mojave River					0.02827552	0.00715074	0.04663153
23	West Fork Mojave River to Silverwood Lake					0.00324449	0.00818122	0.00535117
24	Cedar Springs Dam and Silverwood Lake					0.01024605	0.01251569	0.01690478
25	Silverwood Lake to South Portal San Bernardino Tunnel							
26A	South Portal, San Bernardino Tunnel thru Devil Canyon Pwp.							
28G	Devil Canyon Powerplant to Barton Road							
28H	Barton Road to Lake Perris							
28J	Perris Dam and Lake Perris							
29A	Junction, West Branch, Calif. Aqueduct thru Oso P. P.					0.03544337		
29F	Oso Pumping Plant thru Quail Embankment					0.03544339		
29G	Quail Embankment thru Warne Powerplant					0.03544339		
29H	Pyramid Dam and Lake					0.02817144		
29J	Pyramid Lake thru Castaic Powerplant					0.03544338		
30	Castaic Dam and Lake					0.02927284		
31A	Avenal Gap to Devil's Den Pumping Plant	0.10560301	0.19482503			0.07364766		
33A	Devil's Den Pumping Plant through Tank 1	0.10101221	0.89898779					
33B	Tank 1 through Chorro Valley Turnout	0.09912818	0.90087182					
34	Chorro Valley Turnout through Lopez Turnout	0.05479573	0.94520427					
35	Lopez Turnout through Guadalupe Turnout		1.00000000					

Note: Proportionate use factors do not reflect permanent water transfer as a result of the Monterey Amendment.



**TABLE B-1. Factors for Distributing Reach Capital Costs among Contractors**

Reach No.	SAN JOAQUIN VALLEY AREA							
	Dudley Ridge Water District	Empire West Side Irrigation District	Future Contractor San Joaquin Valley	Kern County Water Agency		County of Kings	Oak Flat Water District	Tulare Lake Basin Water Storage District
				Municipal and Industrial	Agricultural			
CA-AQ								
1	0.01707770	0.00089678	0.00254693	0.02741768	0.30629913	0.00090695	0.00167121	0.03504975
2A	0.01781031	0.00092482	0.00266258	0.02864263	0.31945188	0.00094747	0.00174288	0.03655331
2B	0.01785838	0.00092731	0.00266550	0.02868743	0.32030556	0.00094896		0.03665201
3	0.01786337	0.00092757	0.00266499	0.02868589	0.32039254	0.00094892		0.03666225
4	0.01786863	0.00092785	0.00266446	0.02868428	0.32048398	0.00094886		0.03667303
5	0.01787517	0.00092819	0.00266380	0.02868227	0.32059816	0.00094879		0.03668649
6	0.01788508	0.00092870	0.00266279	0.02867923	0.32077093	0.00094868		0.03670685
7	0.01788826	0.00092887	0.00266246	0.02867825	0.32082633	0.00094864		0.03671338
8C	0.01789228	0.00092909	0.00266205	0.02867702	0.32089625	0.00094859		0.03672162
8D	0.01828779		0.00271703	0.02928147	0.32798200			0.01820857
9				0.03204523	0.32739538			
10A				0.03257442	0.31658608			
11B				0.03597398	0.24684668			
12D				0.03787171	0.20804762			
12E				0.03793198	0.20695175			
13B				0.01458796	0.16600071			
14A				0.00620338	0.13319181			
14B				0.00632023	0.11741558			
14C				0.00651962	0.09039633			
15A				0.00663252	0.07516317			
16A				0.00688973	0.04028829			
17E				0.00212516				
31A			0.05046240		0.57546190			

Reach No.	SOUTHERN CALIFORNIA AREA (continued)								Total
	Littlerock Creek Irrigation District	Mojave Water Agency	Palmdale Water District	San Bernardino	San Gabriel Valley	San Geronio	The Metropolitan	Ventura County	
				Municipal Water District	Municipal Water District	Pass Water Agency	Water District of Southern California	Watershed Protection District	
CA-AQ									
1	0.00049180	0.01101147	0.00369131	0.02362857	0.00650354	0.00398392	0.43929350	0.00429212	1.00000000
2A	0.00051413	0.01151136	0.00385891	0.02469101	0.00679699	0.00416304	0.45921072	0.00448701	1.00000000
2B	0.00051469	0.01152409	0.00386317	0.02472511	0.00680570	0.00416880	0.45973548	0.00449194	1.00000000
3	0.00051461	0.01152193	0.00386244	0.02472246	0.00680478	0.00416835	0.45965407	0.00449108	1.00000000
4	0.00051451	0.01151965	0.00386167	0.02471968	0.00680380	0.00416787	0.45956848	0.00449019	1.00000000
5	0.00051440	0.01151681	0.00386070	0.02471620	0.00680259	0.00416730	0.45946161	0.00448907	1.00000000
6	0.00051419	0.01151251	0.00385926	0.02471095	0.00680076	0.00416640	0.45929991	0.00448738	1.00000000
7	0.00051413	0.01151113	0.00385879	0.02470927	0.00680016	0.00416612	0.45924807	0.00448685	1.00000000
8C	0.00051405	0.01150938	0.00385821	0.02470716	0.00679941	0.00416576	0.45918261	0.00448616	1.00000000
8D	0.00052466	0.01174718	0.00393793	0.02522383	0.00694100	0.00425288	0.46868533	0.00457883	1.00000000
9	0.00057339	0.01283841	0.00430367	0.02758959	0.00758975	0.00465175	0.51227887	0.00500407	1.00000000
10A	0.00058254	0.01304366	0.00437246	0.02803943	0.00771262	0.00472760	0.52049091	0.00508405	1.00000000
11B	0.00064171	0.01436906	0.00481665	0.03093503	0.00850448	0.00521581	0.57349473	0.00560046	1.00000000
12D	0.00067463	0.01510596	0.00506361	0.03254889	0.00894541	0.00548790	0.60297374	0.00588755	1.00000000
12E	0.00067553	0.01512626	0.00507040	0.03259749	0.00895830	0.00549608	0.60379667	0.00589546	1.00000000
13B	0.00073290	0.01641098	0.00550099	0.03540212	0.00972547	0.00596896	0.65516902	0.00639604	1.00000000
14A	0.00076961	0.01723325	0.00577656	0.03720681	0.01021819	0.00627322	0.68807273	0.00671639	1.00000000
14B	0.00078354	0.01754538	0.00588113	0.03789703	0.01040613	0.00638960	0.70057530	0.00683798	1.00000000
14C	0.00080743	0.01808019	0.00606036	0.03907670	0.01072763	0.00658850	0.72199174	0.00704634	1.00000000
15A	0.00082089	0.01838154	0.00616135	0.03974336	0.01090913	0.00670088	0.73406357	0.00716371	1.00000000
16A	0.00085171	0.01907194	0.00639271	0.04126559	0.01132404	0.00695754	0.76170731	0.00743264	1.00000000
17E	0.00089182	0.01997003	0.00669365	0.04325018	0.01186455	0.00729213	0.79767940	0.00778251	1.00000000
17F	0.00089372	0.02001251	0.00670788	0.04334270	0.01189888	0.00730773	0.79937767	0.00779906	1.00000000
18A	0.00221525	0.04960424	0.01662680	0.10730448	0.02944860	0.01809192	0.57469530	1.00000000	1.00000000
19	0.00221522	0.04960300	0.01662640	0.10730707	0.02944876	0.01809230	0.57469556	1.00000000	1.00000000
19C									1.00000000
20A	0.00237800	0.05324853	0.01784830	0.11522152	0.03161798	0.01942666	0.61700971	1.00000000	1.00000000
20B	0.00249470	0.05586076	0.01872390	0.12087843	0.03316986	0.02038045	0.64729087	1.00000000	1.00000000
21	0.00254199	0.05692053		0.12319480	0.03380324	0.02077093	0.65963498	1.00000000	1.00000000
22A		0.05773082		0.12495766	0.03428605	0.02106816	0.66905054	1.00000000	1.00000000
22B		0.05842136		0.12645207	0.03469614	0.02132008	0.67705256	1.00000000	1.00000000
23				0.14467451	0.03969010	0.02439237	0.77446614	1.00000000	1.00000000
24				0.22243002	0.04339444	0.02843498	0.66607404	1.00000000	1.00000000
25				0.14947726	0.03997502	0.02520426	0.78534346	1.00000000	1.00000000
26A				0.14947726	0.03997502	0.02520426	0.78534346	1.00000000	1.00000000
28G				0.05126137			0.94873863	1.00000000	1.00000000
28H							1.00000000	1.00000000	1.00000000
28J							1.00000000	1.00000000	1.00000000
29A							0.95147783	0.01307880	1.00000000
29F							0.95147785	0.01307876	1.00000000
29G							0.95147785	0.01307876	1.00000000
29H							0.96278381	0.00904475	1.00000000
29J							0.95147787	0.01307875	1.00000000
30							0.96212388	0.00860328	1.00000000
31A									1.00000000
33A									1.00000000
34									1.00000000
35									1.00000000

**TABLE B-2. Factors for Distributing Reach Minimum OMP&R Costs Among Contractors**

Reach No.	Reach Description	NORTH BAY AREA		SOUTH BAY AREA				Total
		Napa County FC&WCD	Solano County WA	Alameda County FC&WCD, Zone 7	Alameda County Water District	Santa Clara Valley Water District	Future Contractor South Bay	
<b>NORTH BAY AQUEDUCT</b>								
1	Barker Slough thru Fairfield/Vacaville Turnout	0.29251728	0.70748272					1.00000000
2	Fairfield/Vacaville Turnout to Cordelia Forebay	0.42000793	0.57998207					1.00000000
3A	Cordelia Forebay thru Benicia and Vallejo Turnouts		1.00000000					1.00000000
3B	Cordelia Forebay thru Napa Turnout Reservoir	1.00000000						1.00000000
<b>SOUTH BAY AQUEDUCT</b>								
1	Bethany Reservoir thru Altamont Turnout			0.33980110	0.19515838	0.46504052	0.00000000	1.00000000
2	Altamont Turnout thru Patterson Reservoir			0.33978741	0.19516252	0.46505007	0.00000000	1.00000000
4	Patterson Reservoir to Del Valle Junction			0.31610985	0.20216089	0.48172926	0.00000000	1.00000000
5	Del Valle Junction thru Lake Del Valle			0.53312173	0.12972254	0.33715573	0.00000000	1.00000000
6	Del Valle Junction thru South Livermore Turnout			0.32478705	0.19906896	0.47614399	0.00000000	1.00000000
7	South Livermore Turnout thru Vallecitos Turnout			0.14604872	0.25176680	0.60218448	0.00000000	1.00000000
8	Vallecitos Turnout thru Alameda-Bayside Turnout				0.27934645	0.72065355		1.00000000
9	Alameda-Bayside Turnout thru Santa Clara Terminal Facilities					1.00000000		1.00000000
<b>CALIFORNIA AQUEDUCT</b>								
1	Delta thru Bethany Reservoir				0.00870649	0.02074717		N/A

Reach No.	Reach Description	CENTRAL COASTAL AREA		SOUTHERN CALIFORNIA AREA				
		San Luis Obispo County FC&WCD	Santa Barbara County FC&WCD	Antelope Valley-East Kern Water Agency	Castaic Lake Water Agency	Coachella Valley Water District	Crestline-Lake Arrowhead Water Agency	Desert Water Agency
<b>CALIFORNIA AQUEDUCT</b>								
1	Delta thru Bethany Reservoir	0.00531803	0.00981112	0.03024584	0.02544226	0.02816849	0.00133276	0.01137611
2A	Bethany Reservoir to Orestimba Creek	0.00557057	0.01027704	0.03167950	0.02660598	0.02949522	0.00139543	0.01191224
2B	Orestimba Creek to O'Neill Forebay	0.00557667	0.01028833	0.03171597	0.02666336	0.02953453	0.00139736	0.01192791
3	O'Neill Forebay to Dos Amigos Pumping Plant	0.00557562	0.01028637	0.03171043	0.02666656	0.02953095	0.00139720	0.01192641
4	Dos Amigos Pumping Plant to Panoche Creek	0.00557450	0.01028431	0.03170463	0.02666994	0.02952719	0.00139705	0.01192482
5	Panoche Creek to Five Points	0.00557309	0.01028175	0.03169736	0.02667416	0.02952249	0.00139687	0.01192284
6	Five Points to Arroyo Pasajero	0.00557099	0.01027787	0.03168637	0.02668054	0.02951539	0.00139656	0.01191985
7	Arroyo Pasajero to Kettleman City	0.00557031	0.01027662	0.03168285	0.02668259	0.02951311	0.00139646	0.01191888
8C	Kettleman City thru Milham Avenue	0.00551445	0.01017357	0.03136136	0.02635185	0.02920164	0.00138158	0.01179354
8D	Milham Avenue thru Avenal Gap	0.00562665	0.01038055	0.03200083	0.02691146	0.02980153	0.00141001	0.01203564
9	Avenal Gap thru Twisselman Road			0.03436980	0.02785985	0.03125286	0.00153069	0.01306310
10A	Twisselman Road thru Lost Hills			0.03490578	0.02831966	0.03174218	0.00155504	0.01326985
11B	Lost Hills to 7th Standard Road			0.03824176	0.03115437	0.03478569	0.00170600	0.01455350
12D	7th Standard Road thru Elk Hills Road			0.04009312	0.03274031	0.03647572	0.00179001	0.01526741
12E	Elk Hills Road thru Tupman Road			0.04014397	0.03279589	0.03652306	0.00179253	0.01528847
13B	Tupman Road to Buena Vista Pumping Plant			0.04343323	0.03558110	0.03952321	0.00194122	0.01655295
14A	Buena Vista Pumping Plant thru Santiago Creek			0.04552298	0.03718058	0.04143137	0.00203618	0.01735961
14B	Santiago Creek thru Old River Road			0.04617191	0.03342424	0.04202703	0.00206642	0.01761493
14C	Old River Road to Wheeler Ridge Pumping Plant			0.04735241	0.03220394	0.04310736	0.00212063	0.01807432
15A	Wheeler Ridge Pumping Plant to Chrisman Pumping Plant			0.04804398	0.03267426	0.04374004	0.00215235	0.01834317
16A	Chrisman Pumping Plant to Edmonston Pumping Plant			0.04964403	0.03376234	0.04520241	0.00222537	0.01896287
17E	Edmonston Pumping Plant to Porter Tunnel			0.05163545	0.03511660	0.04702307	0.00231640	0.01973513
17F	Porter Tunnel to Junction, West Branch, Calif. Aqueduct			0.05173926	0.03518719	0.04711769	0.00232108	0.01977493
18A	Junction, West Branch, Calif. Aqueduct thru Alamo Pwp.			0.13485569		0.11344457	0.00605083	0.05154915
19	Alamo Powerplant to Fairmont			0.13485222		0.11344290	0.00605098	0.05154980
19C	Buttes Junction thru Buttes Reservoir			1.00000000				
20A	Fairmont thru 70th Street West			0.06847930		0.12213523	0.00651583	0.05550703
20B	70th Street West to Palmdale			0.02276024		0.12812785	0.00683566	0.05823170
21	Palmdale to Littlerock Creek			0.02318952		0.13056387	0.00696663	0.05934507
22A	Littlerock Creek to Pearblossom Pumping Plant			0.01181870		0.13242454	0.00706632	0.06019328
22B	Pearblossom Pumping Plant to West Fork Mojave River					0.13400843	0.00715085	0.06091324
23	West Fork Mojave River to Silverwood Lake					0.12416451	0.00818135	0.02168414
24	Cedar Springs Dam and Silverwood Lake					0.02651510	0.01251569	0.01910229
25	Silverwood Lake to South Portal San Bernardino Tunnel					0.09751351		0.01317145
26A	South Portal, San Bernardino Tunnel thru Devil Canyon Pwp.					0.12013473		0.01622697
28G	Devil Canyon Powerplant to Barton Road					0.30672992		0.04143095
28H	Barton Road to Lake Perris					0.32330286		0.04366951
28J	Perris Dam and Lake Perris					0.32330202		0.04366970
29A	Junction, West Branch, Calif. Aqueduct thru Oso P. P.			0.00296720		0.05726734		
29F	Oso Pumping Plant thru Quail Embankment			0.00296796		0.05726649		
29G	Quail Embankment thru Warne Powerplant					0.05742327		
29H	Pyramid Dam and Lake					0.03349572		
29J	Pyramid Lake thru Castaic Powerplant					0.05740996		
30	Castaic Dam and Lake					0.03248607		
31A	Avenal Gap to Devil's Den Pumping Plant	0.10542164	0.19449108					
33A	Devil's Den Pumping Plant thru Tank 1	0.10101221	0.89898779			0.07351496		
33B	Tank 1 thru Chorro Valley Turnout	0.10101221	0.89898779					
34	Chorro Valley Turnout through Lopez Turnout	0.05271277	0.94728723					
35	Lopez Turnout thru Guadalupe Turnout		1.00000000					

Note: Proportionate use factors reflect permanent capacity water transfer that have been signed as of February 1, 2007.

**TABLE B-2. Factors for Distributing Reach Minimum OMP&R Costs Among Contractors**

Reach No.	SAN JOAQUIN VALLEY AREA										
	Napa County FC&WCD	Solano County WA	Alameda County FC&WCD, Zone 7	Dudley Ridge Water District	Empire West Side Irrigation District	Future Contractor San Joaquin Valley	Kern County Water Agency		County of Kings	Oak Flat Water District	Tulare Lake Basin Water Storage District
							Municipal and Industrial	Agricultural			
CA-AQ											
1	0.00101503	0.00145926	0.02320270	0.01822142	0.00088480	0.00254117	0.02735295	0.27469072	0.00247193	0.00166749	0.02830375
2A	0.00106167	0.00152624	0.00868437	0.01903859	0.00092448	0.00286184	0.02863089	0.28700500	0.00258450	0.00174223	0.02957310
2B	0.00106383	0.00152939	0.00870009	0.01908995	0.00092696	0.00266476	0.02867562	0.28778222	0.00259040		0.02965288
3	0.00106393	0.00152954	0.00870024	0.01909529	0.00092722	0.00266425	0.02867409	0.28786344	0.00259080		0.02966116
4	0.00106401	0.00152968	0.00870041	0.01910089	0.00092749	0.00266370	0.02867248	0.28794882	0.00259124		0.02966986
5	0.00106413	0.00152986	0.00870062	0.01910789	0.00092783	0.00266303	0.02867046	0.28805544	0.00259177		0.02968073
6	0.00106431	0.00153014	0.00870096	0.01911848	0.00092835	0.00266203	0.02866740	0.28821677	0.00259258		0.02969716
7	0.00106438	0.00153022	0.00870107	0.01912188	0.00092852	0.00266169	0.02866642	0.28826851	0.00259284		0.02970244
8C	0.00105148	0.00151159	0.00859994	0.01886176	0.00091590	0.00263501	0.02834912	0.28434072	0.00255999		0.02929844
8D	0.00107370	0.00154358	0.00878005	0.01927090		0.00268862	0.02893698	0.29051094	0.00165734		0.01089124
9	0.00079826	0.00110157	0.00786471				0.03143148	0.29263291			
10A	0.00081139	0.00111953	0.00799211				0.03193731	0.28144288			
11B	0.00065052	0.00095254	0.00354792				0.03506894	0.21771722			
12D							0.03681479	0.18486151			
12E							0.03687019	0.18374304			
13B							0.01413733	0.14208658			
14A							0.00599913	0.10936622			
14B							0.00609042	0.10066378			
14C							0.00625275	0.07940837			
15A							0.00634765	0.06578229			
16A							0.00656553	0.03434119			
17E							0.00201100				
31A	0.00628695	0.00977801	0.02617705			0.05037550		0.43917148	0.00176551		

Reach No.	SOUTHERN CALIFORNIA AREA (continued)									Total
	Littlerock Creek Irrigation District	Mojave Water Agency	Palmdale Water District	San Bernardino Municipal Water District	San Gabriel Valley Municipal Water District	San Geronio Pass Water Agency	The Metropolitan Water District of Southern California	Ventura County Watershed Protection District		
CA-AQ										
1	0.00049056	0.01818303	0.00458550	0.02356891	0.00648711	0.00397380	0.41547239	0.00427921		1.00000000
2A	0.00051386	0.01902951	0.00480271	0.02467716	0.00679322	0.00416065	0.43517158	0.00448242		1.00000000
2B	0.00051442	0.01906116	0.00480833	0.02471121	0.00680191	0.00416639	0.43566900	0.00448735		1.00000000
3	0.00051433	0.01906070	0.00480752	0.02470855	0.00680098	0.00416594	0.43559198	0.00448650		1.00000000
4	0.00051424	0.01906023	0.00480668	0.02470576	0.00680000	0.00416546	0.43551100	0.00448561		1.00000000
5	0.00051412	0.01905962	0.00480562	0.02470229	0.00679878	0.00416487	0.43540988	0.00448450		1.00000000
6	0.00051392	0.01905870	0.00480402	0.02469702	0.00679694	0.00416399	0.43525686	0.00448280		1.00000000
7	0.00051385	0.01905842	0.00480349	0.02469533	0.00679634	0.00416372	0.43520780	0.00448226		1.00000000
8C	0.00050870	0.01884315	0.00475451	0.02443210	0.00672541	0.00411933	0.44227753	0.00443733		1.00000000
8D	0.00051904	0.01923550	0.00485156	0.02493497	0.00686329	0.00420412	0.45134389	0.00452761		1.00000000
9	0.00056296	0.01845645	0.00526337	0.02706903	0.00744835	0.00456392	0.48981993	0.00491076		1.00000000
10A	0.00057175	0.01874332	0.00534585	0.02749934	0.00756597	0.00463648	0.49755423	0.00498733		1.00000000
11B	0.00062640	0.02052979	0.00585888	0.03016888	0.00829640	0.00508658	0.54559067	0.00546394		1.00000000
12D	0.00065673	0.02152073	0.00605960	0.03165452	0.00870248	0.00533707	0.57229756	0.00572844		1.00000000
12E	0.00065758	0.02154749	0.00606732	0.03169920	0.00871431	0.00534461	0.57307663	0.00573571		1.00000000
13B	0.00071145	0.02330931	0.00656455	0.03432822	0.00943394	0.00578787	0.62040339	0.00620565		1.00000000
14A	0.00074569	0.02442760	0.00688049	0.03600736	0.00989269	0.00607098	0.65057491	0.00650421		1.00000000
14B	0.00075633	0.02477336	0.00697864	0.03654173	0.01003745	0.00616108	0.66009578	0.00659690		1.00000000
14C	0.00077566	0.02540391	0.00715715	0.03750028	0.01029837	0.00632270	0.67725661	0.00676554		1.00000000
15A	0.00078697	0.02577340	0.00726173	0.03806102	0.01045107	0.00641723	0.68730050	0.00686434		1.00000000
16A	0.00081317	0.02662897	0.00750366	0.03935225	0.01080332	0.00663493	0.71046704	0.00709292		1.00000000
17E	0.00084580	0.02769354	0.00780477	0.04096189	0.01124220	0.00690630	0.73933042	0.00737743		1.00000000
17F	0.00084750	0.02774917	0.00782046	0.04104458	0.01126486	0.00692025	0.74082077	0.00739226		1.00000000
18A	0.00220895	0.04946256	0.01657935	0.10699871	0.02936451	0.01804030	0.47144538			1.00000000
19	0.00220892	0.04946131	0.01657891	0.10700135	0.02936470	0.01804074	0.47144817			1.00000000
19C										1.00000000
20A	0.00237900	0.05324853	0.01784830	0.11522152	0.03161788	0.01942666	0.50762172			1.00000000
20B	0.00249470	0.05586076	0.01872390	0.12097843	0.03316974	0.02038045	0.53253657			1.00000000
21	0.00254199	0.05692053		0.12319479	0.03380312	0.02077093	0.54270355			1.00000000
22A		0.05773082		0.12495766	0.03428593	0.02106816	0.55045459			1.00000000
22B		0.05842136		0.12645207	0.03469602	0.02132008	0.55703795			1.00000000
23				0.14467451	0.03969010	0.02439237	0.63721302			1.00000000
24				0.22243002	0.04339445	0.02843498	0.64760747			1.00000000
25				0.11825184	0.03722720	0.01993915	0.71389685			1.00000000
26A				0.14947726	0.03997501	0.02520426	0.64898177			1.00000000
28G							0.60057777			1.00000000
28H				0.05126136			0.63302763			1.00000000
28J							0.63302828			1.00000000
29A							0.92702291	0.01274255		1.00000000
29F							0.92702302	0.01274253		1.00000000
29G							0.92979606	0.01278067		1.00000000
29H							0.95753173	0.00897255		1.00000000
29J							0.92980918	0.01278086		1.00000000
30							0.95895422	0.00855971		1.00000000
31A		0.09301782								1.00000000
33A										1.00000000
33B										1.00000000
34										1.00000000
35										1.00000000

**TABLE B-3. Power Costs and Credits, Transmission costs and Annual Replacement Deposits for Each Aqueduct Pumping and Power Recovery Plant (a)**

(in dollars)

Sheet 1 of 3

Calendar Year	NORTH BAY AQUEDUCT			SOUTH BAY AQUEDUCT	CALIFORNIA AQUEDUCT			
	Reach 1	Reach 3A	Reach 3B	Reach 1 (c)	Reach 1	Reach 4	Reach 14A	Reach 15A
	Barker Slough Pumping P.	Cordelia Pumping P. Solano	Cordelia Pumping P. Napa (b)	South Bay & Del Valle Pumping P.	Banks Pumping P.	Dos Amigos Pumping P.	Buena Vista Pumping P.	Teerink Pumping P.
	[1]	[2]	[3]	[4]	[5]	[6]	[7]	[8]
1961	0	0	0	0	0	0	0	0
1962	0	0	0	37,731	0	0	0	0
1963	0	0	0	56,414	0	0	0	0
1964	0	0	0	71,745	0	0	0	0
1965	0	0	0	138,653	0	0	0	0
1966	0	0	0	189,402	0	0	0	0
1967	0	0	0	220,327	28,554	0	0	0
1968	0	0	7,128	339,261	1,286,777	227,505	0	0
1969	0	0	8,557	274,851	817,304	119,303	0	0
1970	0	0	13,666	439,983	330,508	193,720	2,940	0
1971	0	0	10,626	413,657	559,946	205,206	134,340	7,921
1972	0	0	14,430	615,164	1,072,833	541,628	305,868	159,125
1973	0	0	14,453	477,134	880,234	469,676	469,104	472,187
1974	0	0	17,508	502,473	959,269	536,361	514,168	553,285
1975	0	0	14,801	373,706	1,315,916	536,495	607,981	664,738
1976	0	0	20,867	580,607	878,728	572,326	658,261	645,377
1977	0	0	22,640	534,087	631,578	178,904	139,856	138,714
1978	0	0	21,670	559,981	3,833,011	653,606	966,756	926,444
1979	0	0	16,240	614,117	3,394,344	994,921	805,839	788,539
1980	0	0	19,936	523,445	1,981,918	818,368	857,033	846,757
1981	0	0	23,863	639,976	1,975,220	1,640,814	1,197,553	1,189,437
1982	0	0	12,078	484,808	3,405,761	1,148,258	1,159,605	1,212,973
1983	0	0	2,339	77,394	1,264,426	140,742	276,289	264,076
1984	0	0	4,797	289,827	1,390,432	555,409	551,468	508,111
1985	0	0	10,220	456,051	2,830,593	1,283,981	1,336,378	1,378,587
1986	0	0	15,484	827,079	7,180,656	2,282,364	2,290,023	2,343,903
1987	0	0	27,223	901,077	3,924,603	1,996,638	1,851,663	1,885,638
1988	18,112	19,927	23,868	932,456	5,377,272	2,072,091	2,100,427	2,142,121
1989	30,783	45,783	26,501	1,211,118	10,887,880	3,334,006	3,427,675	3,553,496
1990	53,484	67,109	40,793	1,861,178	9,523,541	4,754,649	5,990,489	6,327,687
1991	11,254	10,442	5,983	365,808	3,463,154	723,518	1,263,736	1,445,729
1992	14,484	13,070	9,398	327,309	2,700,240	808,067	1,071,702	1,121,273
1993	(12,340)	(8,753)	(5,393)	(159,836)	(333,548)	(609,139)	(461,719)	(459,965)
1994	54,407	39,608	29,189	823,317	4,438,900	1,938,280	2,325,005	2,375,321
1995	20,699	20,620	11,791	253,482	4,009,296	1,076,372	924,147	887,105
1996	59,545	47,288	23,483	645,189	9,531,541	3,449,781	2,444,752	2,341,848
1997	69,837	52,935	21,955	963,877	7,625,930	3,064,281	2,847,907	2,788,387
1998	(11,058)	(9,488)	(4,554)	(124,695)	296,016	(362,362)	(316,705)	(304,065)
1999	30,114	25,288	10,024	516,703	4,988,797	2,287,161	1,553,244	1,241,104
2000	58,651	42,587	15,094	861,671	8,025,528	3,046,708	2,966,168	3,038,567
2001	360,761	250,331	214,209	4,068,696	24,175,475	9,882,002	14,868,284	15,252,650
2002	191,948	105,385	61,953	2,258,767	17,221,057	6,949,418	8,493,564	8,803,124
2003	181,608	118,767	98,077	2,567,656	21,542,492	9,051,535	10,696,186	11,139,389
2004	246,316	136,402	105,066	2,452,187	21,375,211	9,167,278	12,084,098	12,682,850
2005	279,237	144,265	146,323	2,745,626	29,060,263	12,814,765	12,402,303	12,757,307
2006	245,509	171,670	198,361	2,653,454	25,213,754	10,420,393	11,348,284	12,269,861
2007	396,347	239,684	158,846	3,903,306	21,512,733	11,109,297	16,196,141	17,629,844
2008	483,579	470,598	410,276	6,041,545	42,637,409	18,154,824	21,968,329	25,377,259
2009	395,081	463,302	492,754	5,370,298	48,465,589	20,289,196	23,195,485	26,654,702
2010	318,856	373,914	397,685	4,395,558	36,288,206	15,988,572	18,280,959	21,011,302
2011	521,874	414,700	452,511	7,027,152	45,800,983	20,241,516	24,773,972	24,588,803
2012	540,754	428,969	478,336	7,258,045	43,225,612	20,841,549	25,441,077	25,232,575
2013	590,035	470,850	537,926	7,935,760	56,492,626	23,353,797	28,704,144	28,466,198
2014	633,199	505,673	593,420	8,499,285	51,044,244	25,409,730	31,361,633	31,097,513
2015	649,348	513,314	625,018	8,622,909	57,254,849	25,903,675	32,015,732	31,748,165
2016	662,158	518,585	652,549	8,708,223	64,935,254	26,442,269	32,815,769	32,556,414
2017	660,184	511,059	662,509	8,586,420	58,516,881	26,109,608	32,437,334	32,189,632
2018	684,340	525,913	705,921	8,826,799	56,646,922	26,619,126	32,929,517	32,651,061
2019	706,766	538,973	748,398	9,038,125	67,265,511	28,368,013	35,629,238	35,393,152
2020	677,790	509,300	724,929	8,557,934	59,091,545	26,445,185	33,068,967	32,845,977
2021	678,069	508,458	727,139	8,544,337	58,088,885	26,510,898	33,204,383	32,988,204
2022	657,998	491,896	701,252	8,276,329	53,656,763	25,620,960	32,095,748	31,896,590
2023	661,566	494,839	705,852	8,323,952	57,716,975	25,799,293	32,327,069	32,125,900
2024	684,833	514,039	735,860	8,634,643	63,736,280	26,872,514	33,685,193	33,466,484
2025	681,875	511,596	732,044	8,595,134	53,197,202	26,621,674	33,314,030	33,091,435
2026	686,363	515,300	737,834	8,655,064	66,597,222	27,015,059	33,899,345	33,683,151
2027	676,423	507,099	725,014	8,522,332	59,146,482	26,484,720	33,194,990	32,982,787
2028	680,928	510,815	730,824	8,582,502	60,664,940	26,659,368	33,401,472	33,183,980
2029	672,606	503,950	720,093	8,471,390	57,624,134	26,298,999	32,955,128	32,745,061
2030	677,810	508,244	726,803	8,540,853	60,459,261	26,532,664	33,249,344	33,035,090
2031	668,912	500,902	715,327	8,422,048	53,244,282	25,561,160	31,750,199	31,512,772
2032	681,696	511,450	731,817	8,592,762	60,513,854	26,988,014	33,956,755	33,754,332
2033	714,614	538,611	774,267	9,032,275	61,550,682	27,773,195	34,601,871	34,335,435
2034	689,362	517,775	741,702	8,695,120	59,942,852	27,334,927	34,394,019	34,185,562
2035	675,841	506,617	724,262	8,514,567	58,736,304	26,530,839	33,267,053	33,079,149
TOTAL	20,012,558	15,419,661	19,901,816	267,057,580	1,843,119,892	812,845,670	998,289,568	1,006,898,130

a) Starting with 2005 transmission costs that vary and depend on Power usage are included, therefore recovered through the variable component.  
 b) Power costs for the period 1968 through 1987 are for an interim facility.  
 c) The costs of Del Valle Pumping Plant are combined with those of South Bay Pumping Plant to simplify the cost allocations.

**TABLE B-3. Power Costs and Credits, Transmission costs and Annual Replacement Deposits for Each Aqueduct Pumping and Power Recovery Plant**

(in dollars)

Sheet 2 of 3

Calendar Year	CALIFORNIA AQUEDUCT (continued)							
	Reach 16A	Reach 17E	Reach 18A	Reach 22B	Reach 23	Reach 26A	Reach 2B (EBX)	Reach 3A (EBX)
	Chrisman Pumping P.	Edmonston Pumping P.	Alamo Powerplant	Pearblossom Pumping Plant	Mojave Siphon Powerplant	Devil Canyon Powerplant	Greenspot Pumping Plant	Crafton Hills Pumping P.
[9]	[10]	[11]	[12]	[13]	[14]	[15]	[16]	
1961	0	0	0	0	0	0	0	0
1962	0	0	0	0	0	0	0	0
1963	0	0	0	0	0	0	0	0
1964	0	0	0	0	0	0	0	0
1965	0	0	0	0	0	0	0	0
1966	0	0	0	0	0	0	0	0
1967	0	0	0	0	0	0	0	0
1968	0	0	0	0	0	0	0	0
1969	0	0	0	0	0	0	0	0
1970	0	0	0	0	0	0	0	0
1971	0	0	0	0	0	0	0	0
1972	348,235	1,179,787	0	81,484	0	(3,112)	0	0
1973	829,325	2,961,697	0	586,209	0	(956,197)	0	0
1974	993,796	3,522,973	0	566,546	0	(963,572)	0	0
1975	1,340,518	4,675,938	0	587,227	0	(1,125,945)	0	0
1976	1,360,502	4,740,176	0	871,540	0	(1,567,312)	0	0
1977	291,196	977,258	0	275,980	0	(1,262,960)	0	0
1978	1,728,268	6,104,186	0	1,758,473	0	(3,345,147)	0	0
1979	1,612,105	5,564,009	0	1,770,844	0	(3,381,969)	0	0
1980	1,808,192	6,269,482	0	1,769,468	0	(3,508,195)	0	0
1981	2,731,775	9,388,367	0	2,049,947	0	(3,743,153)	0	0
1982	2,557,070	9,355,533	0	1,614,895	0	(3,149,352)	0	0
1983	545,887	1,827,188	0	301,180	0	(5,905,161)	0	0
1984	1,044,264	3,507,659	0	633,223	0	(7,865,341)	0	0
1985	2,994,227	10,459,919	0	1,140,057	0	(10,664,136)	0	0
1986	5,062,706	17,643,403	(1,080,970)	2,482,042	0	(12,235,312)	0	0
1987	4,119,308	14,361,151	(1,062,392)	1,822,523	0	(10,871,342)	0	0
1988	4,724,696	16,562,202	(810,907)	2,373,442	0	(14,772,519)	0	0
1989	7,936,397	27,756,045	(822,973)	4,130,250	0	(19,098,882)	0	0
1990	14,254,357	50,152,078	(845,641)	6,810,694	0	(21,336,948)	0	0
1991	3,363,863	12,019,190	(351,262)	1,306,263	0	(5,781,948)	0	0
1992	2,503,167	8,677,102	(997,736)	1,116,809	0	(9,903,370)	0	0
1993	(1,018,142)	(3,558,718)	(84,856)	(370,935)	0	(7,956,659)	0	0
1994	5,337,101	18,723,854	(93,031)	2,529,462	0	(12,122,861)	0	0
1995	1,948,905	6,847,537	(1,297,179)	951,513	0	(10,256,635)	0	0
1996	5,156,434	18,332,558	(2,959,744)	2,725,712	(941,959)	(13,155,960)	0	0
1997	6,217,434	22,057,503	(2,876,697)	3,431,693	(1,932,337)	(13,519,660)	0	0
1998	(673,122)	(2,350,976)	(2,244,105)	(439,496)	(1,385,473)	(10,955,475)	0	0
1999	3,232,010	12,564,772	(2,811,928)	1,779,376	(2,482,354)	(14,772,635)	0	0
2000	6,993,104	25,232,758	(5,129,549)	3,969,325	(4,429,149)	(25,856,637)	0	0
2001	34,362,260	126,969,965	(3,298,048)	19,044,251	(3,649,034)	(19,498,071)	0	0
2002	19,884,736	73,074,996	(4,926,146)	10,767,871	(5,255,302)	(24,635,887)	0	0
2003	25,395,240	93,471,977	(3,431,664)	14,896,580	(6,760,773)	(28,000,328)	0	0
2004	28,967,905	106,508,267	(6,227,543)	16,646,955	(7,691,607)	(31,217,777)	75,708	66,415
2005	28,986,891	102,884,711	(6,140,331)	18,267,341	(6,778,759)	(30,592,888)	68,161	47,906
2006	26,736,475	98,356,120	(4,091,143)	18,491,176	(6,391,206)	(34,897,387)	145,736	159,676
2007	38,437,208	141,214,996	(3,065,445)	20,270,753	(6,098,250)	(29,208,525)	268,907	256,246
2008	53,648,549	191,639,646	(7,419,717)	35,040,468	(4,009,864)	(35,844,853)	544,807	675,558
2009	56,224,837	200,786,392	(5,621,200)	37,811,973	(8,263,600)	(31,442,500)	652,221	813,965
2010	44,314,996	158,472,930	(7,209,800)	29,115,481	(8,722,500)	(32,270,000)	479,438	598,335
2011	57,610,478	215,986,661	(5,676,281)	32,337,855	(6,650,250)	(32,188,175)	550,577	687,114
2012	59,118,447	221,618,381	(5,769,388)	33,900,159	(6,829,725)	(32,405,200)	550,577	687,114
2013	66,769,573	250,365,643	(5,758,155)	38,208,617	(6,846,000)	(32,831,750)	550,577	687,114
2014	72,993,328	273,745,894	(5,782,172)	41,234,910	(6,862,800)	(32,782,050)	550,577	687,114
2015	74,534,997	279,542,997	(5,871,801)	42,761,891	(7,063,725)	(33,390,200)	550,577	687,114
2016	76,460,199	286,805,981	(5,934,499)	44,100,528	(7,156,875)	(34,005,575)	550,577	687,114
2017	75,599,269	283,587,303	(5,889,990)	43,304,112	(7,174,350)	(33,978,600)	550,577	687,114
2018	76,668,889	287,555,403	(5,952,829)	44,771,198	(7,497,975)	(34,012,075)	550,577	687,114
2019	83,212,870	312,271,444	(5,999,923)	46,909,035	(7,434,300)	(34,727,425)	550,577	687,114
2020	77,178,043	289,577,862	(5,968,950)	44,257,544	(7,439,925)	(34,666,150)	550,577	687,114
2021	77,521,275	290,882,877	(5,995,458)	44,377,198	(7,505,625)	(34,811,350)	550,577	687,114
2022	74,944,559	281,215,449	(6,023,168)	42,714,305	(7,496,625)	(34,809,700)	550,577	687,114
2023	75,487,315	283,254,913	(6,038,651)	43,098,445	(7,534,575)	(34,804,325)	550,577	687,114
2024	78,654,310	295,143,453	(6,012,989)	45,014,268	(7,548,000)	(34,803,550)	550,577	687,114
2025	77,761,000	291,773,506	(5,984,836)	44,190,291	(7,450,050)	(34,514,225)	550,577	687,114
2026	79,170,901	297,093,871	(6,048,709)	45,505,024	(7,632,075)	(35,124,800)	550,577	687,114
2027	77,511,568	290,853,820	(6,006,644)	44,249,893	(7,471,275)	(34,768,475)	550,577	687,114
2028	77,985,017	292,626,211	(5,985,400)	44,598,592	(7,494,675)	(34,815,075)	550,577	687,114
2029	76,949,499	288,742,406	(5,995,317)	43,953,906	(7,507,125)	(34,810,950)	550,577	687,114
2030	77,634,234	291,312,000	(5,985,494)	44,357,000	(7,494,825)	(34,815,050)	550,577	687,114
2031	74,001,272	277,590,875	(5,989,113)	43,293,315	(7,813,125)	(34,452,000)	550,577	687,114
2032	79,351,399	297,798,550	(6,059,237)	44,731,484	(7,908,300)	(34,774,175)	550,577	687,114
2033	80,676,779	302,666,088	(6,024,927)	47,116,818	(7,942,800)	(34,811,900)	550,577	687,114
2034	80,369,668	301,620,321	(6,054,396)	45,258,668	(7,991,350)	(34,688,400)	550,577	687,114
2035	77,743,829	291,736,345	(6,056,370)	44,449,989	(7,716,375)	(35,001,675)	550,577	687,114
TOTAL	2,332,211,393	8,684,302,885	(223,764,724)	1,347,673,640	(260,244,892)	(1,404,239,461)	15,999,403	19,795,951

**TABLE B-3. Power Costs and Credits, Transmission costs and Annual Replacement Deposits for Each Aqueduct Pumping and Power Recovery Plant**

(in dollars)

Sheet 3 of 3

Calendar Year	CALIFORNIA AQUEDUCT (continued)						GRAND TOTAL
	Reach 4B (EBX) Cherry Valley Pumping P.	Reach 29A Oso Pumping Plant	Reach 29G Warne Powerplant	Reach 29J Castaic Powerplant	Reach 31A Las Perillas and Badger Hill Pumping Plants	Reach 33A Devil's Den, Bluestone and Polonio Pass Pumping Plants	
	[17]	[18]	[19]	[20]	[21]	[22]	
1961	0	0	0	0	0	0	0
1962	0	0	0	0	0	0	37,731
1963	0	0	0	0	0	0	56,414
1964	0	0	0	0	0	0	71,745
1965	0	0	0	0	0	0	138,653
1966	0	0	0	0	0	0	189,402
1967	0	0	0	0	0	0	248,881
1968	0	0	0	0	118,578	0	1,979,249
1969	0	0	0	0	76,920	0	1,296,935
1970	0	0	0	0	134,749	0	1,115,566
1971	0	0	0	0	168,689	0	1,500,385
1972	0	157,005	0	(385,696)	213,251	0	4,300,002
1973	0	238,650	0	(1,193,216)	120,014	0	5,369,270
1974	0	286,640	0	(1,823,397)	119,505	0	5,785,555
1975	0	421,687	0	(2,835,302)	92,012	0	6,669,772
1976	0	278,869	0	(2,512,021)	146,530	0	6,674,450
1977	0	17,319	0	(1,701,284)	84,225	0	327,513
1978	0	215,573	0	(2,361,377)	190,745	0	11,252,189
1979	0	122,134	0	(2,752,003)	203,143	0	9,752,263
1980	0	86,893	0	(2,728,494)	182,996	0	8,927,799
1981	0	382,330	0	(2,854,192)	189,573	0	14,811,510
1982	0	444,009	(973,898)	(3,476,126)	182,427	0	13,978,041
1983	0	59,561	(1,314,237)	(3,904,690)	18,936	0	(6,346,070)
1984	0	135,658	(2,285,362)	844,120	117,585	0	(568,150)
1985	0	739,708	(8,476,552)	(19,162,735)	155,931	0	(15,517,771)
1986	0	1,037,512	(6,269,528)	(11,462,662)	317,622	0	10,434,322
1987	0	914,642	(6,757,040)	(11,630,562)	266,825	0	1,749,955
1988	0	951,580	(7,448,747)	(12,677,211)	237,272	0	1,826,082
1989	0	1,543,985	(8,790,866)	(14,657,167)	309,851	0	20,823,882
1990	0	3,032,334	(11,692,826)	(19,863,014)	466,262	0	49,616,226
1991	0	778,874	(5,250,121)	(8,731,129)	17,608	0	4,660,962
1992	0	541,093	(5,955,563)	(9,599,392)	111,742	0	(7,440,605)
1993	0	(244,261)	(4,607,075)	(9,740,511)	(122,190)	0	(29,754,040)
1994	0	1,039,474	(6,228,273)	(10,867,596)	226,378	(1,127)	10,567,408
1995	0	342,312	(3,827,718)	(7,403,219)	261,423	0	(5,229,549)
1996	0	908,180	(5,026,221)	(8,969,945)	321,137	0	14,933,619
1997	0	990,932	(5,184,788)	(9,027,058)	322,753	208,816	18,123,700
1998	0	(66,088)	(1,888,975)	(4,963,075)	(56,675)	(87,016)	(25,947,387)
1999	0	666,901	(5,526,541)	(9,954,674)	156,194	234,077	(6,262,367)
2000	0	1,216,343	(9,464,490)	(17,958,033)	231,346	380,555	(6,759,453)
2001	0	6,445,378	(7,987,833)	(13,981,232)	1,086,309	2,152,324	210,718,677
2002	0	3,834,216	(10,286,902)	(18,455,024)	545,459	1,320,943	89,954,176
2003	0	4,519,298	(10,281,922)	(17,307,974)	641,112	1,482,405	330,019,661
2004	7,027	5,385,468	(12,033,953)	(20,022,179)	661,852	1,718,113	141,094,059
2005	2,519	4,130,683	(8,251,156)	(13,698,272)	829,541	1,669,939	161,776,375
2006	19,624	3,489,643	(7,208,025)	(12,038,160)	850,765	1,672,305	147,816,885
2007	14,485	7,564,612	(11,322,469)	(21,045,663)	1,134,539	2,085,774	211,653,367
2008	140,682	8,739,115	(11,688,872)	(20,484,588)	1,794,103	4,721,123	333,039,977
2009	167,735	8,633,076	(9,310,000)	(16,515,000)	1,948,382	4,787,727	366,000,415
2010	123,300	7,118,877	(10,232,500)	(18,087,500)	1,573,852	3,889,671	266,219,632
2011	141,595	12,365,818	(15,783,600)	(26,489,900)	2,264,824	6,239,963	365,218,190
2012	141,595	12,373,474	(15,166,000)	(25,589,750)	2,336,702	6,454,695	374,867,998
2013	141,595	13,918,366	(15,745,900)	(26,533,450)	2,547,685	7,084,989	439,110,240
2014	141,595	15,349,465	(16,350,900)	(27,474,150)	2,723,114	7,609,082	474,927,704
2015	141,595	15,419,192	(16,195,075)	(27,196,050)	2,761,600	7,724,051	491,740,173
2016	141,595	15,739,959	(16,378,000)	(27,521,050)	2,788,158	7,803,401	511,372,734
2017	141,595	15,696,846	(16,553,625)	(27,844,950)	2,750,241	7,690,117	498,239,286
2018	141,595	15,544,061	(15,866,450)	(26,739,700)	2,825,074	7,913,681	506,178,162
2019	141,595	17,559,068	(17,564,050)	(29,744,150)	2,890,864	8,110,219	554,551,114
2020	141,595	16,044,998	(16,962,875)	(28,605,000)	2,741,373	7,663,627	507,121,460
2021	141,595	16,155,784	(17,103,250)	(28,864,150)	2,737,142	7,650,979	507,675,081
2022	141,595	15,727,148	(17,179,400)	(28,996,400)	2,653,707	7,401,724	484,928,401
2023	141,595	15,807,631	(17,170,050)	(28,980,700)	2,668,532	7,446,018	492,769,285
2024	141,595	16,387,961	(17,174,325)	(28,988,450)	2,765,254	7,734,964	520,882,028
2025	141,595	16,314,747	(17,174,375)	(28,988,500)	2,752,954	7,698,222	504,503,010
2026	141,595	16,425,910	(17,174,325)	(28,988,450)	2,771,611	7,753,965	526,921,547
2027	141,595	16,205,915	(17,206,350)	(29,039,650)	2,730,292	7,630,518	508,308,745
2028	141,595	16,265,072	(17,146,300)	(28,938,450)	2,749,021	7,686,477	513,324,605
2029	141,595	16,085,129	(17,174,300)	(28,988,500)	2,714,431	7,583,139	502,922,965
2030	141,595	16,214,075	(17,174,350)	(28,988,550)	2,736,056	7,647,746	510,552,197
2031	141,595	15,049,909	(16,066,325)	(27,113,650)	2,699,071	7,537,250	482,492,367
2032	141,595	16,913,407	(17,670,050)	(29,942,350)	2,752,216	7,696,018	519,688,928
2033	141,595	16,387,702	(16,256,200)	(27,577,100)	2,885,041	8,104,777	536,108,514
2034	141,595	17,032,373	(17,689,125)	(29,983,550)	2,784,081	7,791,214	526,340,109
2035	141,595	16,235,962	(17,192,050)	(29,116,400)	2,727,873	7,623,291	508,868,337
TOTAL	4,015,248	470,200,187	(624,689,704)	(1,093,220,253)	84,410,188	215,515,757	14,551,510,494

**Tables B-4 through B-17 Follow**

**TABLE B-4. Annual Table A Amounts to Project Water**

(in acre-feet)

Sheet 1 of 4

Calendar Year	NORTH BAY AREA			SOUTH BAY AREA (a)				CENTRAL COASTAL AREA		
	Napa (b) County FC&WCD	Solano County WA	Total	Alameda County FC&WCD, Zone 7	Alameda County Water District	Santa Clara Valley Water District	Total	San Luis Obispo County FC&WCD	Santa Barbara County FC&WCD	Total
	[1]	[2]	[3]	[4]	[5]	[6]	[7]	[8]	[9]	[10]
1962	0	0	0	0	0	0	0	0	0	0
1963	0	0	0	0	0	0	0	0	0	0
1964	0	0	0	0	0	0	0	0	0	0
1965	0	0	0	0	0	0	0	0	0	0
1966	0	0	0	0	0	0	0	0	0	0
1967	0	0	0	507	5,248	5,783	11,538	0	0	0
1968	0	0	0	6,900	15,000	88,000	109,900	0	0	0
1969	0	0	0	8,200	15,500	75,000	98,700	0	0	0
1970	0	0	0	10,000	16,200	88,000	114,200	0	0	0
1971	0	0	0	11,200	17,000	88,000	116,200	0	0	0
1972	0	0	0	12,400	17,900	88,000	118,300	0	0	0
1973	0	0	0	13,600	18,800	88,000	120,400	0	0	0
1974	0	0	0	14,800	19,600	88,000	122,400	0	0	0
1975	0	0	0	16,000	20,500	88,000	124,500	0	0	0
1976	0	0	0	17,200	21,300	88,000	126,500	0	0	0
1977	0	0	0	18,400	22,200	88,000	128,600	0	0	0
1978	0	0	0	19,600	23,100	88,000	130,700	0	0	0
1979	0	0	0	20,800	23,900	88,000	132,700	0	0	0
1980	0	500	500	22,000	24,800	88,000	134,800	1,000	946	1,946
1981	0	650	650	23,000	26,000	88,000	137,000	1,000	1,813	2,813
1982	0	800	800	24,000	27,200	88,000	139,200	2,000	3,626	5,626
1983	0	950	950	25,000	28,400	88,000	141,400	3,000	5,439	8,439
1984	0	1,100	1,100	26,000	29,600	88,000	143,600	4,500	8,198	12,698
1985	0	1,250	1,250	27,000	30,800	88,000	145,800	7,500	13,638	21,138
1986	0	1,400	1,400	28,000	32,100	88,000	148,100	10,000	18,210	28,210
1987	0	1,550	1,550	29,000	33,300	88,000	150,300	12,500	22,704	35,204
1988	5,745	9,726	15,471	30,000	34,500	88,000	152,500	15,500	28,222	43,722
1989	6,195	18,420	24,615	31,000	35,700	90,000	156,700	20,000	36,342	56,342
1990	6,940	21,250	28,190	32,000	36,900	92,000	160,900	25,000	45,486	70,486
1991	7,290	22,300	29,590	34,000	38,400	94,000	166,400	25,000	45,486	70,486
1992	7,840	24,170	32,010	36,000	39,900	96,000	171,900	25,000	45,486	70,486
1993	8,490	26,130	34,620	38,000	41,400	98,000	177,400	25,000	45,486	70,486
1994	9,135	28,080	37,215	40,000	42,000	100,000	182,000	25,000	45,486	70,486
1995	9,780	34,250	44,030	42,000	42,000	100,000	184,000	25,000	45,486	70,486
1996	10,425	37,800	48,225	44,000	42,000	100,000	186,000	25,000	45,486	70,486
1997	11,065	38,250	49,315	46,000	42,000	100,000	188,000	6,215	38,986	45,201
1998	11,710	38,710	50,420	46,000	42,000	100,000	188,000	6,215	38,986	45,201
1999	15,850	39,170	55,020	46,000	42,000	100,000	188,000	25,000	45,486	70,486
2000	16,325	39,620	55,945	46,000	42,000	100,000	210,000	25,000	45,486	70,486
2001	20,725	45,836	66,561	78,000	42,000	100,000	220,000	25,000	45,486	70,486
2002	21,100	46,296	67,396	78,000	42,000	100,000	220,000	25,000	45,486	70,486
2003	21,475	46,756	68,231	78,400	42,000	100,000	220,400	25,000	45,486	70,486
2004	21,850	47,206	69,056	80,619	42,000	100,000	222,619	25,000	45,486	70,486
2005	22,225	47,256	69,481	80,619	42,000	100,000	222,619	25,000	45,486	70,486
2006	22,550	47,306	69,856	80,619	42,000	100,000	222,619	25,000	45,486	70,486
2007	22,875	47,356	70,231	80,619	42,000	100,000	222,619	25,000	45,486	70,486
2008	23,200	47,406	70,606	80,619	42,000	100,000	222,619	25,000	45,486	70,486
2009	23,525	47,456	70,981	80,619	42,000	100,000	222,619	25,000	45,486	70,486
2010	23,850	47,506	71,356	80,619	42,000	100,000	222,619	25,000	45,486	70,486
2011	24,175	47,556	71,731	80,619	42,000	100,000	222,619	25,000	45,486	70,486
2012	24,500	47,606	72,106	80,619	42,000	100,000	222,619	25,000	45,486	70,486
2013	24,775	47,656	72,431	80,619	42,000	100,000	222,619	25,000	45,486	70,486
2014	25,150	47,706	72,856	80,619	42,000	100,000	222,619	25,000	45,486	70,486
2015	25,825	47,756	73,581	80,619	42,000	100,000	222,619	25,000	45,486	70,486
2016	26,450	47,756	74,206	80,619	42,000	100,000	222,619	25,000	45,486	70,486
2017	27,075	47,756	74,831	80,619	42,000	100,000	222,619	25,000	45,486	70,486
2018	27,700	47,756	75,456	80,619	42,000	100,000	222,619	25,000	45,486	70,486
2019	28,325	47,756	76,081	80,619	42,000	100,000	222,619	25,000	45,486	70,486
2020	28,925	47,756	76,681	80,619	42,000	100,000	222,619	25,000	45,486	70,486
2021	29,025	47,756	76,781	80,619	42,000	100,000	222,619	25,000	45,486	70,486
2022	29,025	47,756	76,781	80,619	42,000	100,000	222,619	25,000	45,486	70,486
2023	29,025	47,756	76,781	80,619	42,000	100,000	222,619	25,000	45,486	70,486
2024	29,025	47,756	76,781	80,619	42,000	100,000	222,619	25,000	45,486	70,486
2025	29,025	47,756	76,781	80,619	42,000	100,000	222,619	25,000	45,486	70,486
2026	29,025	47,756	76,781	80,619	42,000	100,000	222,619	25,000	45,486	70,486
2027	29,025	47,756	76,781	80,619	42,000	100,000	222,619	25,000	45,486	70,486
2028	29,025	47,756	76,781	80,619	42,000	100,000	222,619	25,000	45,486	70,486
2029	29,025	47,756	76,781	80,619	42,000	100,000	222,619	25,000	45,486	70,486
2030	29,025	47,756	76,781	80,619	42,000	100,000	222,619	25,000	45,486	70,486
2031	29,025	47,756	76,781	80,619	42,000	100,000	222,619	25,000	45,486	70,486
2032	29,025	47,756	76,781	80,619	42,000	100,000	222,619	25,000	45,486	70,486
2033	29,025	47,756	76,781	80,619	42,000	100,000	222,619	25,000	45,486	70,486
2034	29,025	47,756	76,781	80,619	42,000	100,000	222,619	25,000	45,486	70,486
2035	29,025	47,756	76,781	80,619	42,000	100,000	222,619	25,000	45,486	70,486
<b>TOTAL</b>	<b>1,048,440</b>	<b>2,049,856</b>	<b>3,098,296</b>	<b>3,720,815</b>	<b>2,459,248</b>	<b>6,510,783</b>	<b>12,690,846</b>	<b>1,189,430</b>	<b>2,218,494</b>	<b>3,407,924</b>

a) Table A quantities for the South Bay area were supplied by non-Project water for the period June 1962 through November 1967. Actual delivery quantities of Project water are shown for 1967.  
 b) District's Table A quantities exclude amounts during the period 1968 through 1987 that were supplied by non-Project water.



**TABLE B-4. Annual Table A Amounts to Project Water**

(in acre-feet)

Sheet 2 of 4

Calendar Year	SAN JOAQUIN VALLEY AREA								
	Dudley Ridge Water District	Empire West Side Irrigation District	Kern County Water Agency			County of Kings	Oak Flat Water District	Tulare Lake Basin Water Storage District	Total
			Municipal and Industrial	Agricultural	Total				
	[11]	[12]	[13]	[14]	[15]	[16]	[17]	[18]	[19]
1962	0	0	0	0	0	0	0	0	0
1963	0	0	0	0	0	0	0	0	0
1964	0	0	0	0	0	0	0	0	0
1965	0	0	0	0	0	0	0	0	0
1966	0	0	0	0	0	0	0	0	0
1967	0	0	0	0	0	0	0	0	0
1968	14,300	1,000	0	46,600	46,600	900	2,300	12,250	77,350
1969	14,325	3,000	0	95,700	95,700	1,200	2,500	46,350	163,075
1970	15,700	3,000	28,700	116,400	145,100	1,300	2,600	34,300	202,000
1971	17,900	3,000	35,700	154,600	190,300	1,300	2,800	36,500	251,800
1972	20,000	3,000	39,200	231,500	270,700	1,400	5,366	112,600	413,066
1973	22,000	3,000	43,500	267,000	310,500	1,500	3,100	43,552	383,652
1974	33,390	3,000	48,000	299,000	347,000	1,500	3,471	72,289	460,650
1975	40,555	3,000	52,700	358,120	410,820	1,600	3,576	86,258	545,809
1976	30,921	3,000	56,100	386,050	442,150	1,600	4,039	61,707	543,417
1977	30,400	3,000	60,600	423,000	483,600	1,700	3,700	59,000	581,400
1978	32,500	0	64,100	470,200	534,300	1,900	3,900	63,300	635,900
1979	38,544	3,000	67,600	516,300	583,900	2,000	4,000	71,241	702,685
1980	41,000	3,000	71,100	563,400	634,500	2,200	5,700	71,700	758,100
1981	41,000	3,000	74,800	616,600	691,400	2,300	4,300	76,000	818,000
1982	41,000	3,000	79,600	665,700	745,300	2,500	4,500	80,200	876,500
1983	42,900	3,000	83,500	721,600	805,100	2,800	3,770	9,548	867,118
1984	45,100	3,000	103,600	757,000	860,600	3,100	4,800	62,611	979,211
1985	47,200	3,000	108,900	806,100	915,000	3,400	4,900	45,549	1,019,049
1986	49,300	3,000	113,400	820,246	933,646	3,700	5,100	97,200	1,091,946
1987	51,400	3,000	119,100	904,400	1,023,500	4,000	5,200	101,400	1,188,500
1988	53,500	3,000	123,900	950,700	1,074,600	4,000	5,400	105,600	1,246,100
1989	55,600	3,000	128,200	984,100	1,112,300	4,000	5,600	109,900	1,290,400
1990	28,850	3,000	134,600	1,018,800	1,153,400	4,000	5,700	118,500	1,313,450
1991	53,411	3,000	134,600	1,018,800	1,153,400	4,000	5,700	118,500	1,338,011
1992	57,700	3,000	134,600	1,018,800	1,153,400	4,000	5,700	118,500	1,342,300
1993	57,700	3,000	134,600	1,018,800	1,153,400	4,000	5,700	118,500	1,342,300
1994	57,700	3,000	134,600	1,018,800	1,153,400	4,000	5,700	118,500	1,342,300
1995	57,700	3,000	134,600	1,018,800	1,153,400	4,000	5,700	118,500	1,342,300
1996	53,370	3,000	134,600	982,460	1,117,060	4,000	5,700	118,500	1,301,630
1997	53,370	3,000	134,600	978,130	1,112,730	4,000	5,700	118,500	1,297,300
1998	53,370	3,000	134,600	953,130	1,087,730	4,000	5,700	118,500	1,272,300
1999	53,370	3,000	134,600	953,130	1,087,730	4,000	5,700	118,500	1,272,300
2000	53,370	3,000	134,600	886,130	1,020,730	4,000	5,700	118,500	1,205,300
2001	53,370	3,000	134,600	866,349	1,000,949	4,000	5,700	118,500	1,185,519
2002	57,343	3,000	134,600	866,349	1,000,949	4,000	5,700	111,527	1,182,519
2003	57,343	3,000	134,600	866,349	1,000,949	4,000	5,700	111,127	1,182,119
2004	57,343	3,000	134,600	864,130	998,730	9,000	5,700	96,227	1,170,000
2005	57,343	3,000	134,600	864,130	998,730	9,000	5,700	96,227	1,170,000
2006	57,343	3,000	134,600	864,130	998,730	9,305	5,700	95,922	1,170,000
2007	57,343	3,000	134,600	864,130	998,730	9,305	5,700	95,922	1,170,000
2008	57,343	3,000	134,600	864,130	998,730	9,305	5,700	95,922	1,170,000
2009	57,343	3,000	134,600	864,130	998,730	9,305	5,700	95,922	1,170,000
2010	57,343	3,000	134,600	864,130	998,730	9,305	5,700	95,922	1,170,000
2011	57,343	3,000	134,600	864,130	998,730	9,305	5,700	95,922	1,170,000
2012	57,343	3,000	134,600	864,130	998,730	9,305	5,700	95,922	1,170,000
2013	57,343	3,000	134,600	864,130	998,730	9,305	5,700	95,922	1,170,000
2014	57,343	3,000	134,600	864,130	998,730	9,305	5,700	95,922	1,170,000
2015	57,343	3,000	134,600	864,130	998,730	9,305	5,700	95,922	1,170,000
2016	57,343	3,000	134,600	864,130	998,730	9,305	5,700	95,922	1,170,000
2017	57,343	3,000	134,600	864,130	998,730	9,305	5,700	95,922	1,170,000
2018	57,343	3,000	134,600	864,130	998,730	9,305	5,700	95,922	1,170,000
2019	57,343	3,000	134,600	864,130	998,730	9,305	5,700	95,922	1,170,000
2020	57,343	3,000	134,600	864,130	998,730	9,305	5,700	95,922	1,170,000
2021	57,343	3,000	134,600	864,130	998,730	9,305	5,700	95,922	1,170,000
2022	57,343	3,000	134,600	864,130	998,730	9,305	5,700	95,922	1,170,000
2023	57,343	3,000	134,600	864,130	998,730	9,305	5,700	95,922	1,170,000
2024	57,343	3,000	134,600	864,130	998,730	9,305	5,700	95,922	1,170,000
2025	57,343	3,000	134,600	864,130	998,730	9,305	5,700	95,922	1,170,000
2026	57,343	3,000	134,600	864,130	998,730	9,305	5,700	95,922	1,170,000
2027	57,343	3,000	134,600	864,130	998,730	9,305	5,700	95,922	1,170,000
2028	57,343	3,000	134,600	864,130	998,730	9,305	5,700	95,922	1,170,000
2029	57,343	3,000	134,600	864,130	998,730	9,305	5,700	95,922	1,170,000
2030	57,343	3,000	134,600	864,130	998,730	9,305	5,700	95,922	1,170,000
2031	57,343	3,000	134,600	864,130	998,730	9,305	5,700	95,922	1,170,000
2032	57,343	3,000	134,600	864,130	998,730	9,305	5,700	95,922	1,170,000
2033	57,343	3,000	134,600	864,130	998,730	9,305	5,700	95,922	1,170,000
2034	57,343	3,000	134,600	864,130	998,730	9,305	5,700	95,922	1,170,000
2035	57,343	3,000	134,600	864,130	998,730	9,305	5,700	95,922	1,170,000
<b>TOTAL</b>	<b>3,361,478</b>	<b>199,000</b>	<b>7,693,900</b>	<b>52,271,303</b>	<b>59,965,203</b>	<b>403,050</b>	<b>352,822</b>	<b>6,173,823</b>	<b>70,455,376</b>

**TABLE B-4. Annual Table A Amounts to Project Water**

(in acre-feet)

Sheet 3 of 4

Calendar Year	SOUTHERN CALIFORNIA AREA									
	Antelope Valley-East Kern Water Agency	Castaic Lake Water Agency	Coachella Valley Water District	Crestline-Lake Arrowhead Water Agency	Desert Water Agency	Littlerock Creek Irrigation District	Mojave Water Agency	Palmdale Water District	San Bernardino Valley Municipal Water District	San Gabriel Valley Municipal Water District
	[20]	[21]	[22]	[23]	[24]	[25]	[26]	[27]	[28]	[29]
1962	0	0	0	0	0	0	0	0	0	0
1963	0	0	0	0	0	0	0	0	0	0
1964	0	0	0	0	0	0	0	0	0	0
1965	0	0	0	0	0	0	0	0	0	0
1966	0	0	0	0	0	0	0	0	0	0
1967	0	0	0	0	0	0	0	0	0	0
1968	0	3,700	0	0	0	0	0	0	0	0
1969	0	5,000	0	0	0	0	0	0	0	0
1970	0	5,700	0	0	0	0	0	0	0	0
1971	0	6,700	0	0	0	0	0	0	0	0
1972	20,000	8,936	5,200	526	8,000	170	8,400	1,620	1,677	122
1973	25,000	12,400	5,800	870	9,000	290	10,700	2,940	48,000	11,500
1974	30,000	15,400	6,400	1,160	10,000	400	13,100	4,260	50,000	12,300
1975	35,000	18,200	7,000	1,450	11,000	520	15,400	5,580	52,500	13,100
1976	44,000	21,200	7,600	1,740	12,000	640	17,800	6,900	55,000	14,000
1977	50,000	24,100	8,421	2,030	13,000	730	20,200	8,220	57,500	14,800
1978	57,000	24,762	9,242	2,320	14,000	920	0	9,340	60,000	15,700
1979	63,000	28,000	10,063	2,610	15,000	1,040	24,900	10,260	62,500	16,600
1980	69,200	30,400	10,884	2,900	17,000	1,150	27,200	11,180	65,500	17,400
1981	75,000	32,800	12,105	3,190	19,000	1,270	23,100	11,700	68,500	18,300
1982	81,300	34,800	13,326	3,480	21,000	1,380	22,843	12,320	71,500	19,100
1983	87,700	37,300	14,547	3,770	23,000	1,500	34,300	12,940	74,500	19,900
1984	35,000	39,600	15,768	4,060	25,000	1,610	36,700	13,560	78,000	20,700
1985	40,000	41,800	16,989	4,350	27,000	1,730	39,000	14,180	81,500	21,800
1986	42,000	43,600	18,210	4,640	29,000	1,840	41,400	14,800	85,000	23,200
1987	44,000	45,600	19,431	4,930	31,500	1,960	43,700	15,420	89,000	24,600
1988	46,000	48,000	20,652	5,220	34,000	2,070	46,000	16,040	93,000	26,000
1989	125,700	50,100	21,873	5,510	36,500	2,190	48,500	16,660	97,000	27,400
1990	132,100	52,000	23,100	5,800	38,100	2,300	50,800	17,300	101,500	28,800
1991	138,400	54,200	23,100	5,800	38,100	2,300	50,800	17,300	102,600	28,800
1992	138,400	54,200	23,100	5,800	38,100	2,300	50,800	17,300	102,600	28,800
1993	138,400	54,200	23,100	5,800	38,100	2,300	50,800	17,300	102,600	28,800
1994	138,400	54,200	23,100	5,800	38,100	2,300	50,800	17,300	102,600	28,800
1995	138,400	54,200	23,100	5,800	38,100	2,300	50,800	17,300	102,600	28,800
1996	138,400	54,200	23,100	5,800	38,100	2,300	50,800	17,300	102,600	28,800
1997	138,400	54,200	23,100	5,800	38,100	2,300	50,800	17,300	102,600	28,800
1998	138,400	54,200	23,100	5,800	38,100	2,300	75,800	17,300	102,600	28,800
1999	138,400	54,200	23,100	5,800	38,100	2,300	75,800	17,300	102,600	28,800
2000	138,400	95,200	23,100	5,800	38,100	2,300	75,800	21,300	102,600	28,800
2001	138,400	95,200	23,100	5,800	38,100	2,300	75,800	21,300	102,600	28,800
2002	141,400	95,200	23,100	5,800	38,100	2,300	75,800	21,300	102,600	28,800
2003	141,400	95,200	23,100	5,800	38,100	2,300	75,800	21,300	102,600	28,800
2004	141,400	95,200	33,000	5,800	38,100	2,300	75,800	21,300	102,600	28,800
2005	141,400	95,200	121,100	5,800	50,000	2,300	75,800	21,300	102,600	28,800
2006	141,400	95,200	121,100	5,800	50,000	2,300	75,800	21,300	102,600	28,800
2007	141,400	95,200	121,100	5,800	50,000	2,300	75,800	21,300	102,600	28,800
2008	141,400	95,200	121,100	5,800	50,000	2,300	75,800	21,300	102,600	28,800
2009	141,400	95,200	121,100	5,800	50,000	2,300	75,800	21,300	102,600	28,800
2010	141,400	95,200	121,100	5,800	50,000	2,300	75,800	21,300	102,600	28,800
2011	141,400	95,200	121,100	5,800	50,000	2,300	75,800	21,300	102,600	28,800
2012	141,400	95,200	121,100	5,800	50,000	2,300	75,800	21,300	102,600	28,800
2013	141,400	95,200	121,100	5,800	50,000	2,300	75,800	21,300	102,600	28,800
2014	141,400	95,200	121,100	5,800	50,000	2,300	75,800	21,300	102,600	28,800
2015	141,400	95,200	121,100	5,800	50,000	2,300	75,800	21,300	102,600	28,800
2016	141,400	95,200	121,100	5,800	50,000	2,300	75,800	21,300	102,600	28,800
2017	141,400	95,200	121,100	5,800	50,000	2,300	75,800	21,300	102,600	28,800
2018	141,400	95,200	121,100	5,800	50,000	2,300	75,800	21,300	102,600	28,800
2019	141,400	95,200	121,100	5,800	50,000	2,300	75,800	21,300	102,600	28,800
2020	141,400	95,200	121,100	5,800	50,000	2,300	75,800	21,300	102,600	28,800
2021	141,400	95,200	121,100	5,800	50,000	2,300	75,800	21,300	102,600	28,800
2022	141,400	95,200	121,100	5,800	50,000	2,300	75,800	21,300	102,600	28,800
2023	141,400	95,200	121,100	5,800	50,000	2,300	75,800	21,300	102,600	28,800
2024	141,400	95,200	121,100	5,800	50,000	2,300	75,800	21,300	102,600	28,800
2025	141,400	95,200	121,100	5,800	50,000	2,300	75,800	21,300	102,600	28,800
2026	141,400	95,200	121,100	5,800	50,000	2,300	75,800	21,300	102,600	28,800
2027	141,400	95,200	121,100	5,800	50,000	2,300	75,800	21,300	102,600	28,800
2028	141,400	95,200	121,100	5,800	50,000	2,300	75,800	21,300	102,600	28,800
2029	141,400	95,200	121,100	5,800	50,000	2,300	75,800	21,300	102,600	28,800
2030	141,400	95,200	121,100	5,800	50,000	2,300	75,800	21,300	102,600	28,800
2031	141,400	95,200	121,100	5,800	50,000	2,300	75,800	21,300	102,600	28,800
2032	141,400	95,200	121,100	5,800	50,000	2,300	75,800	21,300	102,600	28,800
2033	141,400	95,200	121,100	5,800	50,000	2,300	75,800	21,300	102,600	28,800
2034	141,400	95,200	121,100	5,800	50,000	2,300	75,800	21,300	102,600	28,800
2035	141,400	95,200	121,100	5,800	50,000	2,300	75,800	21,300	102,600	28,800
<b>TOTAL</b>	<b>7,432,000</b>	<b>4,545,098</b>	<b>4,334,011</b>	<b>321,556</b>	<b>2,476,500</b>	<b>127,210</b>	<b>3,760,043</b>	<b>1,127,720</b>	<b>5,909,177</b>	<b>1,641,322</b>

**TABLE B-4. Annual Table A Amounts to Project Water**

(in acre-feet)

Sheet 4 of 4

Calendar Year	SOUTHERN CALIFORNIA AREA				FEATHER RIVER AREA				South Bay Area Future Contractor	GRAND TOTAL
	San Geronio Pass Water Agency	The Metropolitan Water District of Southern California	Ventura County Watershed Protection District	Total	City of Yuba City	County of Butte	Plumas County FC&WCD	Total		
	[30]	[31]	[32]	[33]	[34]	[35]	[36]	[37]	[38]	[39]
1962	0	0	0	0	0	0	0	0	0	0
1963	0	0	0	0	0	0	0	0	0	0
1964	0	0	0	0	0	0	0	0	0	0
1965	0	0	0	0	0	0	0	0	0	0
1966	0	0	0	0	0	0	0	0	0	0
1967	0	0	0	0	0	0	0	0	0	11,538
1968	0	0	0	3,700	0	300	250	550	0	191,500
1969	0	0	0	5,000	0	350	270	620	0	267,395
1970	0	0	0	5,700	0	400	300	700	0	322,600
1971	0	0	0	6,700	0	450	440	890	0	375,590
1972	0	154,772	0	209,423	0	500	470	970	0	741,759
1973	0	354,600	0	481,100	0	600	500	1,100	0	986,252
1974	0	454,900	0	597,920	0	700	530	1,230	0	1,182,200
1975	0	555,200	0	714,950	0	1,050	560	1,610	0	1,386,869
1976	0	655,600	0	836,480	0	1,400	590	1,990	0	1,508,387
1977	0	755,900	0	954,901	0	1,800	620	2,420	0	1,667,321
1978	0	856,300	0	1,049,584	0	1,200	650	1,850	0	1,818,034
1979	0	956,600	0	1,190,573	0	1,450	680	2,130	0	2,028,088
1980	6,800	1,057,000	1,000	1,317,614	0	1,100	710	1,810	0	2,214,770
1981	7,800	1,157,300	2,000	1,432,065	0	1,200	740	1,940	0	2,392,468
1982	8,800	1,257,600	3,000	1,550,449	0	1,200	770	1,970	0	2,574,545
1983	9,800	1,358,000	4,000	1,681,257	0	1,200	800	2,000	0	2,701,164
1984	10,800	1,458,300	5,000	1,744,098	1,600	1,200	830	3,630	0	2,884,337
1985	11,800	1,558,700	6,000	1,864,849	1,700	1,200	860	3,760	0	3,055,846
1986	12,900	1,659,300	8,000	1,983,890	2,100	1,200	890	4,190	0	3,257,736
1987	14,000	1,759,800	10,000	2,103,941	2,500	1,200	920	4,620	0	3,484,115
1988	15,100	1,860,400	13,000	2,225,482	2,900	1,200	960	5,060	0	3,688,335
1989	16,200	1,961,000	16,000	2,424,633	3,300	1,200	1,000	5,500	0	3,958,190
1990	17,300	2,011,500	20,000	2,500,600	3,800	1,200	1,040	6,040	0	4,079,666
1991	17,300	2,011,500	20,000	2,510,200	9,600	1,200	1,080	11,880	0	4,126,567
1992	17,300	2,011,500	20,000	2,510,200	9,600	1,200	1,120	11,920	0	4,138,816
1993	17,300	2,011,500	20,000	2,510,200	9,600	1,200	1,160	11,960	0	4,146,966
1994	17,300	2,011,500	20,000	2,510,200	9,600	1,200	1,200	12,000	0	4,154,201
1995	17,300	2,011,500	20,000	2,510,200	9,600	1,200	1,250	12,050	0	4,163,066
1996	0	2,011,500	20,000	2,492,900	9,600	1,200	1,300	12,100	0	4,111,341
1997	0	2,011,500	20,000	2,492,900	9,600	1,200	1,350	12,150	0	4,084,866
1998	0	2,011,500	20,000	2,517,900	9,600	1,200	1,400	12,200	0	4,086,021
1999	2,000	2,011,500	20,000	2,519,900	9,600	2,890	1,450	13,940	0	4,119,646
2000	3,000	2,011,500	20,000	2,565,900	9,600	2,890	1,510	14,000	0	4,121,631
2001	4,000	2,011,500	20,000	2,566,900	9,600	3,500	1,570	14,670	0	4,124,136
2002	4,000	2,011,500	20,000	2,569,900	9,600	3,500	1,630	14,730	0	4,125,031
2003	5,000	2,011,500	20,000	2,570,900	9,600	3,500	1,690	14,790	0	4,126,926
2004	6,000	2,011,500	20,000	2,581,800	9,600	3,500	0	13,100	0	4,127,061
2005	6,500	1,911,500	20,000	2,582,300	9,600	1,200	0	10,800	0	4,125,686
2006	7,000	1,911,500	20,000	2,582,800	9,600	1,200	324	11,124	0	4,126,885
2007	8,650	1,911,500	20,000	2,584,450	9,600	1,200	720	11,520	0	4,129,306
2008	17,300	1,911,500	20,000	2,593,100	9,600	27,500	2,020	39,120	0	4,165,931
2009	17,300	1,911,500	20,000	2,593,100	9,600	27,500	2,090	39,190	0	4,166,376
2010	17,300	1,911,500	20,000	2,593,100	9,600	27,500	2,160	39,260	0	4,166,821
2011	17,300	1,911,500	20,000	2,593,100	9,600	27,500	2,240	39,340	0	4,167,276
2012	17,300	1,911,500	20,000	2,593,100	9,600	27,500	2,320	39,420	0	4,167,731
2013	17,300	1,911,500	20,000	2,593,100	9,600	27,500	2,410	39,510	0	4,168,146
2014	17,300	1,911,500	20,000	2,593,100	9,600	27,500	2,500	39,600	0	4,168,661
2015	17,300	1,911,500	20,000	2,593,100	9,600	27,500	2,600	39,700	0	4,169,486
2016	17,300	1,911,500	20,000	2,593,100	9,600	27,500	2,700	39,800	0	4,170,211
2017	17,300	1,911,500	20,000	2,593,100	9,600	27,500	2,700	39,800	0	4,170,836
2018	17,300	1,911,500	20,000	2,593,100	9,600	27,500	2,700	39,800	0	4,171,461
2019	17,300	1,911,500	20,000	2,593,100	9,600	27,500	2,700	39,800	0	4,172,086
2020	17,300	1,911,500	20,000	2,593,100	9,600	27,500	2,700	39,800	0	4,172,686
2021	17,300	1,911,500	20,000	2,593,100	9,600	27,500	2,700	39,800	0	4,172,786
2022	17,300	1,911,500	20,000	2,593,100	9,600	27,500	2,700	39,800	0	4,172,786
2023	17,300	1,911,500	20,000	2,593,100	9,600	27,500	2,700	39,800	0	4,172,786
2024	17,300	1,911,500	20,000	2,593,100	9,600	27,500	2,700	39,800	0	4,172,786
2025	17,300	1,911,500	20,000	2,593,100	9,600	27,500	2,700	39,800	0	4,172,786
2026	17,300	1,911,500	20,000	2,593,100	9,600	27,500	2,700	39,800	0	4,172,786
2027	17,300	1,911,500	20,000	2,593,100	9,600	27,500	2,700	39,800	0	4,172,786
2028	17,300	1,911,500	20,000	2,593,100	9,600	27,500	2,700	39,800	0	4,172,786
2029	17,300	1,911,500	20,000	2,593,100	9,600	27,500	2,700	39,800	0	4,172,786
2030	17,300	1,911,500	20,000	2,593,100	9,600	27,500	2,700	39,800	0	4,172,786
2031	17,300	1,911,500	20,000	2,593,100	9,600	27,500	2,700	39,800	0	4,172,786
2032	17,300	1,911,500	20,000	2,593,100	9,600	27,500	2,700	39,800	0	4,172,786
2033	17,300	1,911,500	20,000	2,593,100	9,600	27,500	2,700	39,800	0	4,172,786
2034	17,300	1,911,500	20,000	2,593,100	9,600	27,500	2,700	39,800	0	4,172,786
2035	17,300	1,911,500	20,000	2,593,100	9,600	27,500	2,700	39,800	0	4,172,786
<b>TOTAL</b>	<b>748,350</b>	<b>109,260,272</b>	<b>988,000</b>	<b>142,671,259</b>	<b>449,900</b>	<b>826,280</b>	<b>106,474</b>	<b>1,382,654</b>	<b>0</b>	<b>233,706,355</b>

**TABLE B-5A. Annual Water Quantities Delivered from Each Aqueduct Reach to Each Contractor**

(in acre-feet)

Sheet 1 of 16

Calendar Year	Grizzly Valley Pipeline PC	NORTH BAY AQUEDUCT					SOUTH BAY AQUEDUCT					
		Reach 1	Reach 3A	Reach 3A1	Reach 3B	Total	Reach 1		Reach 2	Reach 4	Reach 5	
				NC	NC (a)			AC	AC	AC		AC
		FC&WCD	SCWA	SCWA	FC&WCD	FC&WCD		ACWD	FC&WCD	FC&WCD	FC&WCD	ACWD
	[1]	[2]	[3]	[4]	[5]	[6]	[7]	[8]	[9]	[10]	[11]	[12]
1962	0	0	0	0	0	0	8,412	141	353	0	0	0
1963	0	0	0	0	0	0	10,914	814	917	0	0	0
1964	0	0	0	0	0	0	19,238	248	1,425	0	0	0
1965	0	0	0	0	0	0	15,280	637	1,830	138	0	0
1966	0	0	0	0	0	0	0	2,475	2,537	499	0	0
1967	0	0	0	0	0	0	0	1,527	2,391	862	0	0
1968	0	0	0	0	1,214	1,214	0	1,608	3,799	721	0	5
1969	0	0	0	0	2,687	2,687	0	1,165	3,459	1,851	0	160
1970	70	0	0	0	3,618	3,618	0	1,345	4,558	3,182	0	164
1971	64	0	0	0	2,521	2,521	0	546	1,908	2,403	0	160
1972	505	0	0	0	3,647	3,647	0	1,066	4,605	2,041	1,489	2,777
1973	679	0	0	0	3,792	3,792	0	430	1,123	1,193	0	229
1974	648	0	0	0	4,870	4,870	0	177	0	975	0	162
1975	405	0	0	0	6,840	6,840	0	137	1,783	1,864	0	120
1976	382	0	0	0	7,122	7,122	0	265	7,204	3,384	0	817
1977	303	0	0	0	8,226	8,226	0	210	4,491	2,213	0	524
1978	278	0	0	0	6,034	6,034	0	422	2,426	3,754	0	2,034
1979	329	0	0	0	6,561	6,561	0	197	4,283	5,567	0	3,937
1980	295	0	0	0	6,707	6,707	0	77	3,883	6,686	1,508	0
1981	355	0	0	0	9,001	9,001	0	1,250	4,648	5,273	5,752	1,157
1982	305	0	0	0	1,213	1,213	0	473	3,043	4,406	0	630
1983	262	0	0	0	2,287	2,287	0	179	2,712	1,714	0	50
1984	272	0	0	0	2,923	2,923	0	165	4,219	2,219	0	55
1985	254	0	0	0	4,039	4,039	0	213	5,199	2,060	0	63
1986	317	1,400	0	0	3,519	4,919	0	200	6,052	2,062	0	212
1987	452	1,550	0	0	7,693	9,243	0	218	7,538	2,372	0	285
1988	523	1	9,725	0	5,392	15,118	0	222	8,302	4,681	0	189
1989	486	10	17,246	0	6,195	23,451	0	222	8,051	6,562	0	418
1990	548	3,275	15,856	0	6,940	26,071	0	256	8,160	8,347	0	593
1991	420	3,117	3,855	0	1,380	8,352	0	162	3,676	3,269	0	359
1992	485	5,553	9,220	0	4,001	18,774	0	217	5,177	2,188	0	154
1993	444	14,709	14,471	0	5,286	34,466	0	190	5,843	8,430	1,650	5,964
1994	492	10,343	14,913	0	6,792	32,048	0	132	4,482	5,427	0	822
1995	308	5,452	15,893	0	5,182	26,527	0	278	6,236	7,195	0	955
1996	360	12,930	17,069	0	4,893	34,892	0	277	6,151	5,119	0	388
1997	231	16,029	17,501	0	4,341	37,871	0	138	6,647	6,501	1,323	1,582
1998	0	11,562	18,204	0	5,359	35,125	0	106	3,748	2,493	0	1,277
1999	0	15,191	19,562	0	5,304	40,057	0	148	5,048	8,227	0	1,444
2000	0	15,490	21,525	0	4,958	41,973	0	110	7,464	9,761	0	946
2001	0	14,849	19,737	0	9,345	43,931	0	105	7,822	4,879	0	3,010
2002	0	18,841	19,719	0	6,875	45,435	0	93	7,758	11,619	0	2,446
2003	0	17,260	16,691	9	7,837	41,597	0	108	7,916	11,348	0	2,887
2004	0	20,951	22,051	135	7,999	51,136	0	72	11,754	9,737	0	3,763
2005	0	18,290	19,529	160	7,509	45,488	0	1,430	11,520	10,100	0	1,826
2006	0	16,573	18,943	208	7,581	43,305	0	830	11,546	4,097	0	2,123
2007	0	19,187	27,741	180	11,277	58,385	0	179	10,066	2,563	0	3,107
2008	2,020	13,716	28,129	125	15,400	57,370	0	231	6,690	5,493	0	3,300
2009	2,090	13,716	27,129	125	19,400	60,370	0	231	7,810	10,860	0	3,300
2010	2,160	13,716	33,790	125	19,600	67,231	0	10,531	7,660	10,929	0	3,300
2011	2,240	13,716	33,840	125	19,900	67,581	0	15,031	7,060	10,959	0	3,300
2012	2,320	13,716	33,890	125	20,200	67,931	0	15,831	7,060	10,965	0	3,300
2013	2,410	13,716	33,940	0	25,150	72,806	0	13,260	8,993	25,255	0	4,327
2014	2,500	13,716	33,990	0	25,150	72,856	0	13,260	8,993	25,255	0	4,327
2015	2,600	13,716	34,040	0	25,825	73,581	0	13,260	8,993	25,255	0	4,327
2016	2,700	13,716	34,040	0	26,450	74,206	0	13,260	8,993	25,255	0	4,327
2017	2,700	13,716	34,040	0	27,075	74,831	0	13,260	8,993	25,255	0	4,327
2018	2,700	13,716	34,040	0	27,700	75,456	0	13,260	8,993	25,255	0	3,777
2019	2,700	13,716	34,040	0	28,325	76,081	0	13,260	8,993	25,255	0	4,327
2020	2,700	13,716	34,040	0	28,325	76,081	0	13,260	8,993	25,255	0	4,327
2021	2,700	13,716	34,040	0	29,025	76,781	0	13,260	8,993	25,255	0	4,327
2022	2,700	13,716	34,040	0	29,025	76,781	0	13,260	8,993	25,255	0	4,327
2023	2,700	13,716	34,040	0	29,025	76,781	0	13,260	8,993	25,255	0	4,327
2024	2,700	13,716	34,040	0	29,025	76,781	0	13,260	8,993	25,255	0	4,327
2025	2,700	13,716	34,040	0	29,025	76,781	0	13,260	8,993	25,255	0	4,327
2026	2,700	13,716	34,040	0	29,025	76,781	0	13,260	8,993	25,255	0	4,327
2027	2,700	13,716	34,040	0	29,025	76,781	0	13,260	8,993	25,255	0	4,327
2028	2,700	13,716	34,040	0	29,025	76,781	0	13,260	8,993	25,255	0	4,327
2029	2,700	13,716	34,040	0	29,025	76,781	0	13,260	8,993	25,255	0	4,327
2030	2,700	13,716	34,040	0	29,025	76,781	0	13,260	8,993	25,255	0	4,327
2031	2,700	13,716	34,040	0	29,025	76,781	0	13,260	8,993	25,255	0	4,327
2032	2,700	13,716	34,040	0	29,025	76,781	0	13,260	8,993	25,255	0	4,327
2033	2,700	13,716	34,040	0	29,025	76,781	0	13,260	8,993	25,255	0	4,327
2034	2,700	13,716	34,040	0	29,025	76,781	0	13,260	8,993	25,255	0	4,327
2035	2,700	13,716	34,040	0	29,025	76,781	0	13,260	8,993	25,255	0	4,327
TOTAL	82,812	626,611	1,278,999	1,317	962,635	2,869,562	53,844	368,295	476,872	820,053	11,722	163,265

a) For the period 1968 through 1987, deliveries are non-Project water pumped through an interim facility

**TABLE B-5A. Annual Water Quantities Delivered from Each Aqueduct Reach to Each Contractor**

(in acre-feet)

Sheet 2 of 16

Calendar Year	SOUTH BAY AQUEDUCT (b) (Continued)					CALIFORNIA AQUEDUCT					
	Reach 6 AC	Reach 7	Reach 8	Reach 9	Total	NORTH SAN JOAQUIN DIVISION					
						Reach 2A					
						FC&WCD	ACWD	ACWD	SCVWD	Total	KCWA
OFWD (c)	(M&I)	(AG)									
	[13]	[14]	[15]	[16]	[17]	[18]	[19]	[20]	[21]	[22]	[23]
1962	0	0	0	0	8,906	0	0	0	0	0	0
1963	0	0	0	0	12,645	0	0	0	0	0	0
1964	0	0	0	0	20,911	0	0	0	0	0	0
1965	0	1,127	0	15,014	34,026	0	0	0	0	0	0
1966	0	14,864	0	34,538	54,913	0	0	0	0	0	0
1967	0	12,882	0	39,101	56,763	0	0	0	0	0	0
1968	0	24,817	0	70,105	101,055	3,084	0	0	0	0	0
1969	0	813	0	62,264	69,712	3,016	0	0	0	0	0
1970	0	0	0	80,311	89,560	5,911	0	0	0	0	0
1971	0	5,961	0	87,606	98,584	7,212	0	0	0	0	0
1972	0	26,182	0	100,266	138,426	8,166	0	0	0	0	0
1973	0	2,521	0	88,582	94,078	3,214	0	0	0	0	0
1974	0	0	4	88,000	89,318	3,471	0	0	0	0	0
1975	714	393	593	88,000	93,604	3,576	0	0	0	0	0
1976	5,461	13,774	7,526	88,000	126,431	4,112	0	0	0	0	0
1977	5,206	11,284	7,556	76,220	107,704	1,472	0	0	0	0	0
1978	2,348	854	5,009	95,727	112,574	3,906	0	0	0	0	0
1979	5,341	3,430	7,444	91,991	122,190	6,149	0	0	0	0	0
1980	6,144	2,824	6,702	88,000	115,824	5,700	0	0	0	0	0
1981	7,262	7,595	8,570	88,000	129,507	4,300	0	0	0	0	0
1982	4,571	1,776	4,540	88,000	107,439	3,838	0	0	0	0	0
1983	111	0	3,157	86,733	94,656	3,822	0	0	0	0	0
1984	126	0	3,338	88,000	98,122	5,700	0	0	0	0	0
1985	7,537	11,203	7,813	88,000	122,088	5,433	0	0	0	0	0
1986	2,083	5,311	7,068	88,000	110,988	5,107	0	0	0	0	0
1987	12,993	15,488	9,902	88,000	136,796	5,625	0	0	0	0	0
1988	12,436	24,259	9,205	87,961	147,255	4,412	0	0	0	0	0
1989	10,974	17,340	8,702	90,000	142,269	6,091	0	0	0	300	0
1990	15,678	22,149	9,554	91,800	156,537	2,922	0	0	0	0	200
1991	1,945	9,155	3,493	28,200	50,259	141	0	0	0	0	0
1992	6,933	12,621	6,532	42,839	76,661	2,239	0	0	0	0	0
1993	13,208	1,792	6,829	62,065	105,971	2,858	0	0	0	0	0
1994	9,679	3,379	19,532	57,115	100,568	3,071	0	0	0	0	0
1995	15,427	21	17,772	28,756	76,640	5,169	0	0	0	0	0
1996	6,968	1,871	11,591	44,850	77,215	4,904	0	0	0	0	0
1997	12,654	1,876	10,864	60,601	102,186	5,238	0	0	0	0	0
1998	8,347	3,817	11,478	39,610	70,876	4,401	0	0	0	0	0
1999	13,133	5,326	16,226	52,945	102,497	4,871	0	0	0	0	0
2000	16,396	4,498	18,100	78,258	135,533	4,508	0	0	0	0	0
2001	13,593	0	18,004	47,922	95,335	3,592	638	0	0	0	0
2002	17,058	5,112	20,616	58,875	123,577	4,885	773	0	0	0	0
2003	16,684	5,037	12,753	75,981	132,714	4,266	917	0	7	0	0
2004	21,260	4,968	14,916	59,458	125,928	4,629	786	0	38	0	0
2005	16,597	4,139	10,160	52,364	108,136	4,194	1,046	0	299	0	0
2006	19,870	2,708	12,924	64,174	118,272	4,242	1,103	0	321	1,103	0
2007	23,205	8,255	15,107	71,690	134,172	3,567	1,031	0	320	0	0
2008	29,721	9,778	12,015	80,000	147,228	5,300	0	2,960	50	0	0
2009	24,821	7,002	17,597	80,000	151,621	5,700	0	2,960	50	0	0
2010	14,621	7,004	20,646	80,000	154,691	5,700	0	2,960	50	0	0
2011	12,071	7,004	20,646	80,000	156,071	5,700	0	2,960	50	0	0
2012	12,571	7,004	20,646	80,000	157,377	5,700	0	2,960	50	0	0
2013	10,834	6,982	35,018	90,000	194,669	5,700	0	2,960	53	0	0
2014	18,731	6,982	35,018	90,000	202,566	5,700	0	2,960	53	0	0
2015	18,731	6,982	35,018	90,000	202,566	5,700	0	2,960	53	0	0
2016	18,731	6,982	35,018	90,000	202,566	5,700	0	2,960	53	0	0
2017	18,731	6,982	35,018	90,000	202,566	5,700	0	2,960	53	0	0
2018	17,760	6,982	35,018	90,000	201,045	5,700	0	2,960	53	0	0
2019	18,731	6,982	35,018	90,000	202,566	5,700	0	2,960	53	0	0
2020	18,731	6,982	35,018	90,000	202,566	5,700	0	2,960	53	0	0
2021	18,731	6,982	35,018	90,000	202,566	5,700	0	2,960	53	0	0
2022	18,731	6,982	35,018	90,000	202,566	5,700	0	2,960	53	0	0
2023	18,731	6,982	35,018	90,000	202,566	5,700	0	2,960	53	0	0
2024	18,731	6,982	35,018	90,000	202,566	5,700	0	2,960	53	0	0
2025	18,731	6,982	35,018	90,000	202,566	5,700	0	2,960	53	0	0
2026	18,731	6,982	35,018	90,000	202,566	5,700	0	2,960	53	0	0
2027	18,731	6,982	35,018	90,000	202,566	5,700	0	2,960	53	0	0
2028	18,731	6,982	35,018	90,000	202,566	5,700	0	2,960	53	0	0
2029	18,731	6,982	35,018	90,000	202,566	5,700	0	2,960	53	0	0
2030	18,731	6,982	35,018	90,000	202,566	5,700	0	2,960	53	0	0
2031	18,731	6,982	35,018	90,000	202,566	5,700	0	2,960	53	0	0
2032	18,731	6,982	35,018	90,000	202,566	5,700	0	2,960	53	0	0
2033	18,731	6,982	35,018	90,000	202,566	5,700	0	2,960	53	0	0
2034	18,731	6,982	35,018	90,000	202,566	5,700	0	2,960	53	0	0
2035	18,731	6,982	35,018	90,000	202,566	5,700	0	2,960	53	0	0
TOTAL	847,692	499,800	1,230,544	5,473,922	9,946,009	332,214	6,294	82,880	2,454	300	200

b) For the period June 1962 through November 1967, deliveries were supplied by non-Project water.

c) Includes 425 AF of 1988 advance allocation and 141 AF of 1992 advance allocation.

**TABLE B-5A. Annual Water Quantities Delivered from Each Aqueduct Reach to Each Contractor**

(in acre-feet)

Sheet 3 of 16

Calendar Year	CALIFORNIA AQUEDUCT (continued)									
	SAN LUIS									
	Reach 3					Reach 4				
	MWDSC [24]	DRWD [25]	SCVWD [26]	KCWA		KCWA		DRWD [31]	TLBWSD [32]	
(M&I) [27]				(AG) [28]	(M&I) [29]	(AG) [30]				
1962	0	0	0	0	0	0	0	0	0	
1963	0	0	0	0	0	0	0	0	0	
1964	0	0	0	0	0	0	0	0	0	
1965	0	0	0	0	0	0	0	0	0	
1966	0	0	0	0	0	0	0	0	0	
1967	0	0	0	0	0	0	0	0	0	
1968	0	0	0	0	0	0	0	0	0	
1969	0	0	0	0	0	0	0	0	0	
1970	0	0	0	0	0	0	0	0	0	
1971	0	0	0	0	0	0	0	0	0	
1972	0	0	0	0	0	0	0	0	0	
1973	0	0	0	0	0	0	0	0	0	
1974	0	0	0	0	0	0	0	0	0	
1975	0	0	0	0	0	0	0	0	0	
1976	0	0	0	0	0	0	0	0	0	
1977	0	0	0	0	0	0	0	0	0	
1978	0	0	0	0	0	0	0	0	0	
1979	0	0	0	0	0	0	0	0	0	
1980	0	0	0	0	0	0	0	0	0	
1981	0	0	0	0	0	0	0	0	0	
1982	0	0	0	0	0	0	0	0	0	
1983	0	0	0	0	0	0	0	0	0	
1984	0	0	0	0	0	0	0	0	0	
1985	0	0	0	0	0	0	0	0	0	
1986	0	0	0	0	0	0	0	0	0	
1987	0	0	0	0	0	0	0	0	0	
1988	0	0	0	0	0	0	0	0	0	
1989	0	602	0	0	0	0	12,647	1,898	0	
1990	0	0	0	0	0	0	0	0	1,500	
1991	0	0	0	0	0	0	0	0	0	
1992	0	0	0	0	0	0	0	0	0	
1993	0	0	0	0	0	0	0	0	0	
1994	0	0	0	0	0	0	0	0	0	
1995	0	0	0	0	0	0	3,500	14,446	0	
1996	0	0	0	0	0	1,125	4,162	0	0	
1997	11,100	0	0	0	0	0	0	0	0	
1998	(11,100)	0	0	0	0	0	0	0	0	
1999	0	0	0	0	0	0	0	0	1,300	
2000	0	0	0	3,320	57,825	1,517	(11,928)	0	0	
2001	0	0	30,000	8,790	131,452	0	0	0	0	
2002	0	0	0	21,050	50,346	0	0	0	0	
2003	29,596	0	0	0	151,044	0	1,351	0	0	
2004	0	0	0	0	44,877	0	0	0	0	
2005	50,000	0	8,804	0	109,712	0	7,000	0	0	
2006	0	0	0	0	19,575	0	0	0	0	
2007	0	0	0	71,567	67,533	0	0	0	0	
2008	0	0	0	0	0	0	0	0	0	
2009	0	0	0	0	0	0	0	0	0	
2010	0	0	0	0	0	0	0	0	0	
2011	0	0	0	0	0	0	0	0	0	
2012	0	0	0	0	0	0	0	0	0	
2013	0	0	0	0	0	0	0	0	0	
2014	0	0	0	0	0	0	0	0	0	
2015	0	0	0	0	0	0	0	0	0	
2016	0	0	0	0	0	0	0	0	0	
2017	0	0	0	0	0	0	0	0	0	
2018	0	0	0	0	0	0	0	0	0	
2019	0	0	0	0	0	0	0	0	0	
2020	0	0	0	0	0	0	0	0	0	
2021	0	0	0	0	0	0	0	0	0	
2022	0	0	0	0	0	0	0	0	0	
2023	0	0	0	0	0	0	0	0	0	
2024	0	0	0	0	0	0	0	0	0	
2025	0	0	0	0	0	0	0	0	0	
2026	0	0	0	0	0	0	0	0	0	
2027	0	0	0	0	0	0	0	0	0	
2028	0	0	0	0	0	0	0	0	0	
2029	0	0	0	0	0	0	0	0	0	
2030	0	0	0	0	0	0	0	0	0	
2031	0	0	0	0	0	0	0	0	0	
2032	0	0	0	0	0	0	0	0	0	
2033	0	0	0	0	0	0	0	0	0	
2034	0	0	0	0	0	0	0	0	0	
2035	0	0	0	0	0	0	0	0	0	
<b>TOTAL</b>	<b>79,596</b>	<b>602</b>	<b>38,804</b>	<b>104,727</b>	<b>632,364</b>	<b>2,642</b>	<b>16,732</b>	<b>16,344</b>	<b>2,800</b>	

**TABLE B-5A. Annual Water Quantities Delivered from Each Aqueduct Reach to Each Contractor**

(in acre-feet)

Sheet 4 of 16

Calendar Year	CALIFORNIA AQUEDUCT (continued)											
	SAN LUIS DIVISION (continued)											
	Reach 5						Reach 6					
	DRWD	KCWA		MWDSC	CLWA	TLBWSD	OFWD	CK	KCWA		MWDSC	TLBWSD
(M&I)		(AG)	(M&I)						(AG)			
[33]	[34]	[35]	[36]	[37]	[38]	[39]	[40]	[41]	[42]	[43]	[44]	
1962	0	0	0	0	0	0	0	0	0	0	0	0
1963	0	0	0	0	0	0	0	0	0	0	0	0
1964	0	0	0	0	0	0	0	0	0	0	0	0
1965	0	0	0	0	0	0	0	0	0	0	0	0
1966	0	0	0	0	0	0	0	0	0	0	0	0
1967	0	0	0	0	0	0	0	0	0	0	0	0
1968	0	0	0	0	0	0	0	0	0	0	0	0
1969	0	0	0	0	0	0	0	0	0	0	0	0
1970	0	0	0	0	0	0	0	0	0	0	0	0
1971	0	0	0	0	0	0	0	0	0	0	0	0
1972	0	0	0	0	0	0	0	0	0	0	0	0
1973	0	0	0	0	0	0	0	0	0	0	0	0
1974	0	0	0	0	0	0	0	0	0	0	0	0
1975	0	0	0	0	0	0	0	0	0	0	0	0
1976	0	0	0	0	0	0	0	0	0	0	0	0
1977	0	0	0	0	0	0	0	0	0	0	0	0
1978	0	0	0	0	0	0	0	0	0	0	0	0
1979	0	0	0	0	0	0	0	0	0	0	0	0
1980	0	0	0	0	0	0	0	0	0	0	0	0
1981	0	0	0	0	0	0	0	0	0	0	0	0
1982	0	0	0	0	0	0	0	0	0	0	0	0
1983	0	0	0	0	0	0	0	0	0	0	0	0
1984	0	0	0	0	0	0	0	0	0	0	0	0
1985	0	0	0	0	0	0	0	0	0	0	0	0
1986	0	0	0	0	0	0	0	0	0	0	0	0
1987	0	0	0	0	0	0	0	0	0	0	0	0
1988	0	0	0	0	0	1,550	0	0	0	0	0	0
1989	0	0	18,831	0	0	0	0	0	0	8,260	0	0
1990	0	0	0	0	0	0	0	0	0	0	0	0
1991	0	0	0	0	0	0	0	0	0	0	0	0
1992	10,823	0	0	0	0	0	0	0	0	0	0	0
1993	27,200	0	28,200	0	5,095	1,624	2,000	0	0	31,200	0	0
1994	0	0	0	0	0	0	0	0	0	0	0	0
1995	0	0	21,776	0	0	0	0	0	0	3,932	0	0
1996	0	1,125	81,507	0	0	4,000	0	0	0	0	0	0
1997	0	9,080	154,940	0	0	3,500	0	0	0	0	0	0
1998	0	0	0	0	0	0	0	0	20,400	33,340	0	3,000
1999	0	0	0	21,500	0	8,000	0	0	0	33,776	11,000	23,000
2000	0	8,130	57,647	0	0	0	0	0	1,457	35,847	0	3,000
2001	0	0	0	0	0	2,457	0	0	0	0	0	600
2002	0	0	0	0	0	3,000	0	0	0	0	0	0
2003	0	0	0	0	0	3,900	0	0	0	0	0	0
2004	0	0	0	0	0	3,850	0	0	0	0	0	0
2005	0	0	0	0	0	1,000	0	6,954	0	0	0	0
2006	0	0	0	0	0	3,000	0	2,659	0	0	0	0
2007	0	0	0	0	0	3,600	0	3,119	0	0	0	0
2008	0	0	0	0	0	0	0	5,200	0	0	0	0
2009	0	0	0	0	0	0	0	5,200	0	0	0	0
2010	0	0	0	0	0	0	0	5,200	0	0	0	0
2011	0	0	0	0	0	0	0	5,200	0	0	0	0
2012	0	0	0	0	0	0	0	5,200	0	0	0	0
2013	0	0	0	0	0	0	0	5,200	0	0	0	0
2014	0	0	0	0	0	0	0	5,200	0	0	0	0
2015	0	0	0	0	0	0	0	5,200	0	0	0	0
2016	0	0	0	0	0	0	0	5,200	0	0	0	0
2017	0	0	0	0	0	0	0	5,200	0	0	0	0
2018	0	0	0	0	0	0	0	5,200	0	0	0	0
2019	0	0	0	0	0	0	0	5,200	0	0	0	0
2020	0	0	0	0	0	0	0	5,200	0	0	0	0
2021	0	0	0	0	0	0	0	5,200	0	0	0	0
2022	0	0	0	0	0	0	0	5,200	0	0	0	0
2023	0	0	0	0	0	0	0	5,200	0	0	0	0
2024	0	0	0	0	0	0	0	5,200	0	0	0	0
2025	0	0	0	0	0	0	0	5,200	0	0	0	0
2026	0	0	0	0	0	0	0	5,200	0	0	0	0
2027	0	0	0	0	0	0	0	5,200	0	0	0	0
2028	0	0	0	0	0	0	0	5,200	0	0	0	0
2029	0	0	0	0	0	0	0	5,200	0	0	0	0
2030	0	0	0	0	0	0	0	5,200	0	0	0	0
2031	0	0	0	0	0	0	0	5,200	0	0	0	0
2032	0	0	0	0	0	0	0	5,200	0	0	0	0
2033	0	0	0	0	0	0	0	5,200	0	0	0	0
2034	0	0	0	0	0	0	0	5,200	0	0	0	0
2035	0	0	0	0	0	0	0	5,200	0	0	0	0
<b>TOTAL</b>	<b>38,023</b>	<b>18,335</b>	<b>362,901</b>	<b>21,500</b>	<b>5,095</b>	<b>39,481</b>	<b>2,000</b>	<b>158,332</b>	<b>21,857</b>	<b>146,355</b>	<b>11,000</b>	<b>29,600</b>

**TABLE B-5A. Annual Water Quantities Delivered from Each Aqueduct Reach to Each Contractor**

(in acre-feet)

Sheet 5 of 16

Calendar  Year	CALIFORNIA AQUEDUCT (continued)												
	SOUTH SAN JOAQUIN DIVISION												
	Reach 7						Reach 8C						
	KCWA		CLWA	DRWD	TLBWSD	MWDSC	CK	KCWA		DRWD	TLBWSD	EWSID	CK
(M&I)	(AG)	(M&I)						(AG)					
[45]	[46]	[47]	[48]	[49]	[50]	[51]	[52]	[53]	[54]	[55]	[56]	[57]	
1962	0	0	0	0	0	0	0	0	0	0	0	0	0
1963	0	0	0	0	0	0	0	0	0	0	0	0	0
1964	0	0	0	0	0	0	0	0	0	0	0	0	0
1965	0	0	0	0	0	0	0	0	0	0	0	0	0
1966	0	0	0	0	0	0	0	0	0	0	0	0	0
1967	0	0	0	0	0	0	0	0	0	0	0	0	0
1968	0	0	0	0	0	0	0	0	0	0	25,100	1,978	900
1969	0	0	0	0	0	0	0	0	0	0	7,081	56	100
1970	0	0	0	0	0	0	0	0	0	0	0	3,942	0
1971	0	0	0	0	0	0	0	0	0	0	80,906	5,990	3,700
1972	0	0	0	0	0	0	0	0	0	0	144,843	5,795	1,400
1973	0	0	0	0	0	0	0	0	0	0	26,317	3,000	1,500
1974	0	0	0	0	0	0	0	0	0	0	32,603	3,000	1,500
1975	0	0	0	0	0	0	0	0	0	0	41,536	3,000	1,600
1976	0	0	0	0	0	0	0	0	0	0	26,595	3,000	1,600
1977	0	0	0	0	0	0	0	0	0	0	12,984	738	1,530
1978	0	0	0	0	0	0	0	0	0	0	3,934	454	2,070
1979	0	0	0	0	0	0	0	0	0	0	74,758	1,739	2,000
1980	0	0	0	0	0	0	0	0	0	0	35,140	894	2,200
1981	0	0	0	0	0	0	0	0	0	0	50,888	5,859	2,300
1982	0	0	0	0	0	0	0	0	0	0	4,405	361	1,536
1983	0	0	0	0	0	0	0	0	0	0	1,001	0	3,550
1984	0	0	0	0	0	0	0	0	0	0	3,677	0	3,100
1985	0	0	0	0	0	0	0	0	0	0	68,638	5,197	3,400
1986	0	0	0	0	0	0	0	0	0	0	40,017	1,170	3,700
1987	0	0	0	0	0	0	0	0	0	0	30,359	2,525	4,000
1988	0	0	0	0	0	0	0	0	0	0	46,281	3,475	4,000
1989	0	5,262	0	0	0	0	0	0	2,391	0	63,703	3,000	4,000
1990	0	0	0	0	0	0	0	0	0	0	23,504	1,279	2,000
1991	0	0	0	0	0	0	0	0	0	0	1,697	221	0
1992	0	0	0	0	0	0	0	0	280	0	15,982	1,354	1,806
1993	18,157	10,043	0	0	0	0	0	0	0	0	57,112	2,741	4,000
1994	0	0	2,100	0	0	0	0	0	0	0	21,510	1,666	2,116
1995	10,875	20,595	0	0	0	0	0	989	10,527	0	40,934	1,631	4,000
1996	3,424	69,704	0	0	0	0	0	1,500	95	0	84,130	1,868	4,000
1997	27,079	32,463	0	0	0	0	0	1,500	0	0	9,467	0	0
1998	3,998	62,081	0	200	0	0	0	1,000	90	0	8,956	542	15
1999	7,923	19,500	0	0	4,470	500	0	400	86	0	90,334	3,176	4,000
2000	0	20,970	1,200	0	17,519	20,000	0	400	166	0	63,842	1,799	3,600
2001	0	0	0	0	0	0	0	0	0	14	23,300	1,360	1,560
2002	0	0	0	0	12,067	0	0	0	0	0	34,009	1,405	2,854
2003	0	0	0	0	15,103	0	0	0	0	0	25,317	1,436	3,692
2004	0	0	0	0	0	0	0	0	0	0	30,546	3,562	5,803
2005	0	0	0	0	4,000	0	6,904	0	0	0	42,450	3,834	4,057
2006	0	0	0	0	6,000	0	2,500	0	0	0	34,367	3,282	1,105
2007	0	16,214	0	0	2,545	0	0	0	0	0	31,305	2,084	657
2008	0	0	0	0	0	0	0	0	0	0	38,369	3,000	3,800
2009	0	0	0	0	0	0	0	0	0	0	38,370	3,000	3,800
2010	0	0	0	0	0	0	0	0	0	0	31,370	3,000	3,800
2011	0	0	0	0	0	0	0	0	0	0	31,370	3,000	3,800
2012	0	0	0	0	0	0	0	0	0	0	31,370	3,000	3,800
2013	0	0	0	0	0	0	0	0	0	0	35,569	3,000	3,800
2014	0	0	0	0	0	0	0	0	0	0	35,569	3,000	3,800
2015	0	0	0	0	0	0	0	0	0	0	35,569	3,000	3,800
2016	0	0	0	0	0	0	0	0	0	0	35,569	3,000	3,800
2017	0	0	0	0	0	0	0	0	0	0	35,569	3,000	3,800
2018	0	0	0	0	0	0	0	0	0	0	35,569	3,000	3,800
2019	0	0	0	0	0	0	0	0	0	0	35,569	3,000	3,800
2020	0	0	0	0	0	0	0	0	0	0	35,569	3,000	3,800
2021	0	0	0	0	0	0	0	0	0	0	35,569	3,000	3,800
2022	0	0	0	0	0	0	0	0	0	0	35,569	3,000	3,800
2023	0	0	0	0	0	0	0	0	0	0	35,569	3,000	3,800
2024	0	0	0	0	0	0	0	0	0	0	35,569	3,000	3,800
2025	0	0	0	0	0	0	0	0	0	0	35,569	3,000	3,800
2026	0	0	0	0	0	0	0	0	0	0	35,569	3,000	3,800
2027	0	0	0	0	0	0	0	0	0	0	35,569	3,000	3,800
2028	0	0	0	0	0	0	0	0	0	0	35,569	3,000	3,800
2029	0	0	0	0	0	0	0	0	0	0	35,569	3,000	3,800
2030	0	0	0	0	0	0	0	0	0	0	35,569	3,000	3,800
2031	0	0	0	0	0	0	0	0	0	0	35,569	3,000	3,800
2032	0	0	0	0	0	0	0	0	0	0	35,569	3,000	3,800
2033	0	0	0	0	0	0	0	0	0	0	35,569	3,000	3,800
2034	0	0	0	0	0	0	0	0	0	0	35,569	3,000	3,800
2035	0	0	0	0	0	0	0	0	0	0	35,569	3,000	3,800
TOTAL	71,456	256,832	3,300	200	61,704	20,500	9,404	989	15,327	3,122	2,448,464	172,413	201,351



**TABLE B-5A. Annual Water Quantities Delivered from Each Aqueduct Reach to Each Contractor**

(in acre-feet)

Sheet 6 of 16

Calendar  Year	CALIFORNIA AQUEDUCT (continued)											
	SOUTH SAN JOAQUIN DIVISION (continued)											
	Reach 8D						Reach 9					
	KCWA		DRWD	CK	SBC	SLOC	TLBWSD	DRWD	KCWA		TLBWSD	
(M&I)	(AG)	(M&I)							(AG)			
[58]	[59]	[60]	[61]	[62]	[63]	[64]	[65]	[66]	[67]	[68]		
1962	0	0	0	0	0	0	0	0	0	0	0	
1963	0	0	0	0	0	0	0	0	0	0	0	
1964	0	0	0	0	0	0	0	0	0	0	0	
1965	0	0	0	0	0	0	0	0	0	0	0	
1966	0	0	0	0	0	0	0	0	0	0	0	
1967	0	0	0	0	0	0	0	0	0	0	0	
1968	0	0	26,360	0	0	0	0	0	0	30,951	0	
1969	0	0	31,375	0	0	0	0	0	0	24,489	0	
1970	0	0	40,407	0	0	0	3,408	0	0	46,114	1,855	
1971	0	0	41,053	0	0	0	41,579	0	0	58,356	0	
1972	0	0	42,443	0	0	0	113,550	0	0	75,464	0	
1973	0	1,500	22,057	0	0	0	24,147	0	0	54,583	0	
1974	0	0	33,390	0	0	0	39,686	0	0	63,814	0	
1975	0	0	40,555	0	0	0	44,722	0	0	50,021	0	
1976	0	0	41,421	0	0	0	32,216	0	0	53,465	0	
1977	0	0	11,153	0	0	0	5,097	0	0	24,668	0	
1978	0	0	51,747	0	0	0	8,119	0	0	72,231	0	
1979	0	0	38,544	0	0	0	80,363	0	0	74,524	0	
1980	0	0	41,000	0	0	0	40,304	0	0	79,946	0	
1981	0	0	41,000	0	0	0	32,550	0	0	76,508	0	
1982	0	0	41,000	214	0	0	14,146	0	0	76,877	0	
1983	0	0	42,900	0	0	0	5	0	2,217	84,573	0	
1984	0	0	45,100	0	0	0	2,066	0	4,100	85,732	0	
1985	0	0	46,251	0	0	0	41,153	0	0	67,696	0	
1986	0	0	50,249	0	0	0	39,338	0	0	79,943	0	
1987	0	0	46,288	0	0	0	62,725	0	0	97,732	0	
1988	0	0	47,994	0	0	0	48,035	0	1,100	83,858	0	
1989	0	0	52,158	0	0	0	63,947	0	0	91,134	0	
1990	0	161	36,296	0	0	0	32,066	0	0	83,108	0	
1991	0	0	927	0	0	0	483	0	13,683	601	0	
1992	0	0	12,667	0	0	0	30,746	0	28	40,183	0	
1993	0	0	23,221	0	0	0	65,732	197	5,945	53,597	0	
1994	0	1,726	28,793	0	0	0	40,852	0	0	44,994	0	
1995	2,959	27,270	45,240	0	0	0	57,435	0	0	64,076	0	
1996	0	1,455	52,722	0	0	100	148,745	0	2,236	89,291	0	
1997	0	0	57,496	0	0	100	9,402	4,900	0	72,013	0	
1998	0	20,000	49,435	0	0	0	8,721	0	0	57,530	0	
1999	0	9,000	58,290	0	0	0	162,631	0	0	72,734	0	
2000	0	0	57,920	0	0	0	113,952	0	2,000	71,562	0	
2001	0	6,089	39,801	0	0	0	58,369	0	0	54,198	0	
2002	0	7,522	48,179	0	0	0	47,426	0	0	60,957	0	
2003	0	8,350	45,732	0	0	0	61,521	0	0	54,724	0	
2004	0	4,979	45,823	3,250	0	0	55,625	0	0	54,330	0	
2005	0	0	58,627	1,891	0	0	92,552	0	0	53,206	0	
2006	0	0	61,410	3,266	0	0	64,840	0	0	56,909	0	
2007	0	7,740	39,974	1,921	0	0	49,633	0	0	66,018	0	
2008	0	0	49,343	0	0	0	57,553	0	0	70,300	0	
2009	0	0	57,343	0	0	0	57,552	0	0	76,300	0	
2010	0	0	57,343	0	0	0	57,552	0	0	76,300	0	
2011	0	0	57,343	0	0	0	57,552	0	0	76,300	0	
2012	0	0	57,343	0	0	0	57,552	0	0	76,300	0	
2013	0	0	57,343	0	0	0	53,353	0	0	75,270	0	
2014	0	0	57,343	0	0	0	53,353	0	0	75,270	0	
2015	0	0	57,343	0	0	0	53,353	0	0	75,270	0	
2016	0	0	57,343	0	0	0	53,353	0	0	75,270	0	
2017	0	0	57,343	0	0	0	53,353	0	0	75,270	0	
2018	0	0	57,343	0	0	0	53,353	0	0	75,270	0	
2019	0	0	57,343	0	0	0	53,353	0	0	75,270	0	
2020	0	0	57,343	0	0	0	53,353	0	0	75,270	0	
2021	0	0	57,343	0	0	0	53,353	0	0	75,270	0	
2022	0	0	57,343	0	0	0	53,353	0	0	75,270	0	
2023	0	0	57,343	0	0	0	53,353	0	0	75,270	0	
2024	0	0	57,343	0	0	0	53,353	0	0	75,270	0	
2025	0	0	57,343	0	0	0	53,353	0	0	75,270	0	
2026	0	0	57,343	0	0	0	53,353	0	0	75,270	0	
2027	0	0	57,343	0	0	0	53,353	0	0	75,270	0	
2028	0	0	57,343	0	0	0	53,353	0	0	75,270	0	
2029	0	0	57,343	0	0	0	53,353	0	0	75,270	0	
2030	0	0	57,343	0	0	0	53,353	0	0	75,270	0	
2031	0	0	57,343	0	0	0	53,353	0	0	75,270	0	
2032	0	0	57,343	0	0	0	53,353	0	0	75,270	0	
2033	0	0	57,343	0	0	0	53,353	0	0	75,270	0	
2034	0	0	57,343	0	0	0	53,353	0	0	75,270	0	
2035	0	0	57,343	0	0	0	53,353	0	0	75,270	0	
TOTAL	2,959	95,792	3,234,602	10,542	0	200	3,352,767	5,097	31,309	4,609,420	1,855	

**TABLE B-5A. Annual Water Quantities Delivered from Each Aqueduct Reach to Each Contractor**

(in acre-feet)

Sheet 7 of 16

Calendar  Year	CALIFORNIA AQUEDUCT (continued)									
	SOUTH SAN JOAQUIN DIVISION (continued)									
	Reach 10A									
	KCWA		DRWD	AC	CLWA	SCVWD	ACWD	MWDSC	TLBWS	D
(M&I)	(AG)									
[70]	[71]	[72]	[73]	[74]	[75]	[76]	[77]	[78]		
1962	0	0	0	0	0	0	0	0	0	0
1963	0	0	0	0	0	0	0	0	0	0
1964	0	0	0	0	0	0	0	0	0	0
1965	0	0	0	0	0	0	0	0	0	0
1966	0	0	0	0	0	0	0	0	0	0
1967	0	0	0	0	0	0	0	0	0	0
1968	0	0	0	0	0	0	0	0	0	0
1969	0	0	0	0	0	0	0	0	0	2,842
1970	0	158	0	0	0	0	0	0	0	4,315
1971	0	9,973	0	0	0	0	0	0	0	0
1972	0	5,876	0	0	0	0	0	0	0	0
1973	0	22,948	0	0	0	0	0	0	0	0
1974	10,019	22,719	0	0	0	0	0	0	0	0
1975	2,791	72,121	0	0	0	0	0	0	0	0
1976	74	50,444	0	0	0	0	0	0	0	0
1977	201	34,451	0	0	0	0	0	0	0	0
1978	0	161,889	0	0	0	0	0	0	0	0
1979	285	153,245	0	0	0	0	0	0	0	0
1980	3,780	131,836	0	0	0	0	0	0	0	0
1981	341	133,500	0	0	0	0	0	0	0	0
1982	4,700	164,832	0	0	0	0	0	0	0	0
1983	0	146,493	0	0	0	0	0	0	0	0
1984	6,910	150,302	0	0	0	0	0	0	0	0
1985	6,495	153,473	0	0	0	0	0	0	0	0
1986	5,065	198,099	0	0	0	0	0	0	0	0
1987	900	228,521	0	0	0	0	0	0	0	0
1988	9,529	212,495	0	0	0	0	0	0	0	0
1989	21,038	251,979	0	0	0	0	0	0	0	0
1990	25,189	47,472	0	0	0	0	0	0	0	0
1991	1,142	6,820	0	0	0	0	0	0	0	0
1992	3,685	89,390	0	0	0	0	0	0	0	0
1993	775	233,862	0	0	0	0	0	44,496	0	0
1994	5,227	126,792	0	0	0	0	0	0	0	0
1995	366	229,448	0	0	0	0	0	50,000	0	0
1996	6,666	199,854	0	0	0	45,000	6,200	95,000	0	0
1997	3,577	157,385	900	0	0	35,000	10,000	125,000	0	0
1998	2,603	163,587	0	1,970	0	23,800	3,780	39,500	0	0
1999	1,657	190,787	0	22,910	0	30,000	16,100	75,850	0	0
2000	16,880	274,000	0	23,940	0	23,730	13,380	9,208	0	0
2001	160	98,175	0	5,000	0	0	0	0	0	0
2002	7,645	163,998	0	14,287	24,000	3,311	2,083	0	0	0
2003	2,648	172,243	0	6,500	0	33,000	18,800	70,940	0	0
2004	65,743	122,099	0	5,740	32,522	0	8,000	0	0	0
2005	22,087	210,578	0	0	0	55,448	28,422	31,210	0	0
2006	0	237,623	5,000	5,740	0	64,036	27,447	0	0	0
2007	0	203,794	3,000	717	0	3,892	1,029	0	0	0
2008	0	201,460	0	5,200	0	10,000	18,207	0	0	0
2009	0	200,268	0	5,200	0	10,000	15,401	168,300	0	0
2010	0	200,268	0	5,200	0	10,000	12,350	185,550	0	0
2011	0	200,268	0	5,200	0	10,000	12,350	185,550	0	0
2012	0	200,268	0	5,200	0	10,000	12,350	185,550	0	0
2013	0	201,660	0	0	0	10,000	0	247,682	0	0
2014	0	201,660	0	0	0	10,000	0	247,682	0	0
2015	0	201,660	0	0	0	10,000	0	247,682	0	0
2016	0	201,660	0	0	0	10,000	0	247,682	0	0
2017	0	201,660	0	0	0	10,000	0	247,682	0	0
2018	0	201,660	0	0	0	10,000	0	247,682	0	0
2019	0	201,660	0	0	0	10,000	0	247,682	0	0
2020	0	201,660	0	0	0	10,000	0	247,682	0	0
2021	0	201,660	0	0	0	10,000	0	247,682	0	0
2022	0	201,660	0	0	0	10,000	0	247,682	0	0
2023	0	201,660	0	0	0	10,000	0	247,682	0	0
2024	0	201,660	0	0	0	10,000	0	247,682	0	0
2025	0	201,660	0	0	0	10,000	0	247,682	0	0
2026	0	201,660	0	0	0	10,000	0	247,682	0	0
2027	0	201,660	0	0	0	10,000	0	247,682	0	0
2028	0	201,660	0	0	0	10,000	0	247,682	0	0
2029	0	201,660	0	0	0	10,000	0	247,682	0	0
2030	0	201,660	0	0	0	10,000	0	247,682	0	0
2031	0	201,660	0	0	0	10,000	0	247,682	0	0
2032	0	201,660	0	0	0	10,000	0	247,682	0	0
2033	0	201,660	0	0	0	10,000	0	247,682	0	0
2034	0	201,660	0	0	0	10,000	0	247,682	0	0
2035	0	201,660	0	0	0	10,000	0	247,682	0	0
TOTAL	238,178	10,871,973	8,900	112,804	56,522	597,017	205,899	6,962,840	7,157	

**TABLE B-5A. Annual Water Quantities Delivered from Each Aqueduct Reach to Each Contractor**

(in acre-feet)

Sheet 8 of 16

Calendar  Year	CALIFORNIA AQUEDUCT (continued)										
	SOUTH SAN JOAQUIN DIVISION (continued)										
	Reach 11B			Reach 12D		Reach 12E					
	KCWA		DRWD	KCWA		ACWD	AC		CLWA	SCVWD	DRWD
(M&I)	(AG)	(M&I)		(AG)	FC&WCD						
	[79]	[80]	[81]	[82]	[83]	[84]	[85]	[86]	[87]	[88]	[89]
1962	0	0	0	0	0	0	0	0	0	0	0
1963	0	0	0	0	0	0	0	0	0	0	0
1964	0	0	0	0	0	0	0	0	0	0	0
1965	0	0	0	0	0	0	0	0	0	0	0
1966	0	0	0	0	0	0	0	0	0	0	0
1967	0	0	0	0	0	0	0	0	0	0	0
1968	0	24,776	0	0	0	0	0	0	0	0	0
1969	0	64,682	0	0	0	0	0	0	0	0	0
1970	0	72,279	0	0	0	0	0	0	0	0	0
1971	0	63,773	0	0	0	0	0	0	0	0	0
1972	0	72,358	0	0	0	0	0	0	0	0	0
1973	0	67,544	0	0	0	0	0	0	0	0	0
1974	0	87,476	0	0	0	0	0	0	0	0	0
1975	0	85,675	0	0	0	0	0	0	0	0	0
1976	0	85,067	0	0	0	0	0	0	0	0	0
1977	3,981	29,603	0	0	0	0	0	0	0	0	0
1978	0	88,753	0	0	0	0	0	0	0	0	0
1979	484	108,379	0	0	0	0	0	0	0	0	0
1980	3,112	103,207	0	0	0	0	0	0	0	0	0
1981	494	104,395	0	0	0	0	0	0	0	0	0
1982	798	99,081	0	0	0	0	0	0	0	0	0
1983	2,069	94,117	0	0	0	0	0	0	0	0	0
1984	2,349	124,819	0	0	0	0	0	0	0	0	0
1985	10,666	118,646	0	0	0	0	0	0	0	0	0
1986	8,673	124,836	0	0	0	0	0	0	0	0	0
1987	13,074	111,877	0	0	0	0	0	0	0	0	0
1988	13,509	114,031	0	0	0	0	0	0	0	0	0
1989	9,986	127,058	0	0	0	0	0	0	0	0	0
1990	9,319	104,107	0	0	0	0	0	0	0	0	0
1991	6,099	118	0	0	0	0	0	0	0	0	0
1992	7,419	35,093	0	0	0	0	0	0	0	0	0
1993	2,696	72,645	0	0	0	0	0	0	0	0	5,504
1994	3,506	71,202	0	0	0	0	0	0	0	0	0
1995	1,154	97,072	0	0	0	0	0	0	0	1,000	0
1996	1,185	96,250	0	0	0	0	0	0	0	4,131	0
1997	1,111	104,823	0	0	0	0	0	0	0	8,012	1,486
1998	1,311	72,646	0	0	0	0	0	0	0	5,925	24,234
1999	2,127	92,262	0	0	0	0	0	0	0	1,321	62,162
2000	3,793	89,623	1,500	21	0	0	0	0	0	953	159,731
2001	636	73,105	0	41	0	0	0	0	0	0	0
2002	1,457	91,123	0	760	6	0	0	0	0	0	0
2003	1,379	87,174	0	2,431	152	0	0	0	0	0	45,989
2004	1,299	97,722	0	3,419	768	0	0	0	0	1,600	0
2005	824	93,554	0	2,841	644	1,878	3,419	20,000	2,619	1,154	15,384
2006	0	98,417	0	2,513	1,556	0	9,914	20,000	0	0	5,065
2007	4,030	94,334	0	2,164	2,284	0	0	8,200	0	0	5,000
2008	0	90,900	0	6,500	0	0	14,000	20,000	0	0	0
2009	0	87,600	0	6,500	0	0	14,000	10,600	0	0	0
2010	0	87,600	0	6,500	0	0	14,000	8,600	0	0	0
2011	0	87,600	0	6,500	0	0	14,000	7,600	0	0	0
2012	0	87,600	0	6,500	0	0	12,000	5,600	0	0	0
2013	0	89,708	0	6,500	0	0	10,000	0	0	0	0
2014	0	103,391	0	6,500	0	0	10,000	0	0	0	0
2015	0	103,391	0	6,500	0	0	10,000	0	0	0	0
2016	0	103,391	0	6,500	0	0	10,000	0	0	0	0
2017	0	103,391	0	6,500	0	0	10,000	0	0	0	0
2018	0	103,391	0	6,500	0	0	10,000	0	0	0	0
2019	0	103,391	0	6,500	0	0	10,000	0	0	0	0
2020	0	103,391	0	6,500	0	0	10,000	0	0	0	0
2021	0	103,391	0	6,500	0	0	10,000	0	0	0	0
2022	0	103,391	0	6,500	0	0	10,000	0	0	0	0
2023	0	103,391	0	6,500	0	0	10,000	0	0	0	0
2024	0	103,391	0	6,500	0	0	10,000	0	0	0	0
2025	0	103,391	0	6,500	0	0	10,000	0	0	0	0
2026	0	103,391	0	6,500	0	0	10,000	0	0	0	0
2027	0	103,391	0	6,500	0	0	10,000	0	0	0	0
2028	0	103,391	0	6,500	0	0	10,000	0	0	0	0
2029	0	103,391	0	6,500	0	0	10,000	0	0	0	0
2030	0	103,391	0	6,500	0	0	10,000	0	0	0	0
2031	0	103,391	0	6,500	0	0	10,000	0	0	0	0
2032	0	103,391	0	6,500	0	0	10,000	0	0	0	0
2033	0	103,391	0	6,500	0	0	10,000	0	0	0	0
2034	0	103,391	0	6,500	0	0	10,000	0	0	0	0
2035	0	103,391	0	6,500	0	0	10,000	0	0	0	0
TOTAL	118,540	6,249,312	1,500	196,190	5,410	1,878	311,333	100,600	2,619	24,096	324,555

**TABLE B-5A. Annual Water Quantities Delivered from Each Aqueduct Reach to Each Contractor**

(in acre-feet)

Sheet 9 of 16

Calendar  Year	CALIFORNIA AQUEDUCT (continued)												
	SOUTH SAN JOAQUIN DIVISION (continued)												
	Reach 12E		Reach 13B							Reach 14A		Reach 14B	
	KCWA		KCWA		AC					KCWA		KCWA	
(M&I)	(AG)	(M&I)	(AG)	FC&WCD	SCVWD	MWDSC	DRWD	TLBWSD	(M&I)	(AG)	(M&I)	(AG)	
[90]	[91]	[92]	[93]	[94]	[95]	[96]	[97]	[98]	[99]	[100]	[101]	[102]	
1962	0	0	0	0	0	0	0	0	0	0	0	0	
1963	0	0	0	0	0	0	0	0	0	0	0	0	
1964	0	0	0	0	0	0	0	0	0	0	0	0	
1965	0	0	0	0	0	0	0	0	0	0	0	0	
1966	0	0	0	0	0	0	0	0	0	0	0	0	
1967	0	0	0	0	0	0	0	0	0	0	0	0	
1968	0	0	0	0	0	0	0	0	0	0	0	0	
1969	0	0	0	0	0	0	0	0	0	0	0	0	
1970	0	9,279	0	4,891	0	0	0	0	0	0	0	3	
1971	0	28,056	0	0	0	0	0	0	0	23,844	0	49,929	
1972	0	62,342	0	17,388	0	0	0	0	0	26,621	0	77,034	
1973	0	13,082	0	9,297	0	0	0	0	0	15,328	0	47,040	
1974	2,651	4,248	8,038	4,246	0	0	0	0	0	7,794	0	32,356	
1975	0	10,787	8,538	7,059	0	0	0	0	0	10,306	0	27,736	
1976	37,519	20,555	5,626	8,855	0	0	0	0	0	268	0	35,296	
1977	20,280	1,737	0	5,024	0	0	0	0	0	8,299	0	13,539	
1978	47,133	15,011	21,773	7,601	0	0	0	0	0	34,029	0	72,351	
1979	50,740	61,567	5,663	17,766	0	0	0	0	3,012	27,356	0	59,413	
1980	32,039	22,252	0	22,515	0	0	0	0	4,312	16,876	0	40,513	
1981	59,917	58,470	7,844	14,037	0	0	0	0	4,511	13,007	8	42,753	
1982	36,139	75,587	0	25,553	0	0	0	0	3,735	24,240	184	57,739	
1983	0	10,950	0	3,491	0	0	0	0	1,168	20,302	0	57,922	
1984	63,941	39,929	12,117	26,178	0	0	0	0	137	35,369	10	79,179	
1985	69,839	84,117	0	67,711	0	0	0	0	206	33,103	0	72,855	
1986	62,109	51,540	0	66,551	0	0	0	0	180	26,384	0	70,864	
1987	95,297	86,223	5,609	40,374	0	0	0	0	610	30,098	9	67,710	
1988	86,390	123,249	9,298	47,167	0	0	0	0	622	32,778	19	75,968	
1989	83,965	146,544	5,504	57,114	0	0	0	0	721	29,292	7	82,201	
1990	82,164	38,973	7,645	20,423	0	0	0	0	673	26,800	13	81,076	
1991	8,842	303	0	0	0	0	0	0	768	0	0	0	
1992	47,181	57,048	789	17,449	0	0	0	0	673	16,238	464	41,143	
1993	84,822	285,554	12,798	88,157	0	0	0	0	629	17,832	0	62,493	
1994	66,188	77,839	2,494	33,148	0	0	0	0	2,513	16,760	3,000	54,011	
1995	107,130	181,097	8,751	110,685	0	0	0	3,500	3	21,234	0	67,391	
1996	89,257	134,138	28,063	64,849	0	0	0	0	0	26,978	0	85,936	
1997	32,061	128,329	43,803	49,312	0	0	0	0	0	23,035	0	79,790	
1998	28,258	88,998	29,444	40,085	0	5,500	0	0	0	15,706	0	58,132	
1999	110,161	255,343	12,969	92,998	0	0	0	0	0	21,153	0	67,576	
2000	78,285	89,702	4,066	98,136	0	0	0	0	0	19,264	0	70,585	
2001	5,256	46,205	4,044	29,881	0	0	1,733	0	1	12,451	0	49,602	
2002	39,104	96,231	15,951	55,493	0	0	736	0	0	11,161	0	52,762	
2003	64,196	87,339	35,239	91,739	0	1,865	350	0	0	13,685	0	44,576	
2004	52,303	95,893	1,922	73,801	0	0	1,657	0	0	13,030	0	52,012	
2005	43,835	340,281	21,781	269,631	2,321	9,014	192	14,540	0	15,663	0	56,739	
2006	82,207	296,316	11,787	196,029	87	0	0	5,670	0	17,779	0	65,142	
2007	1,179	88,795	0	72,240	0	0	0	2,161	0	21,435	0	67,955	
2008	88,800	121,094	18,500	86,094	0	0	0	4,000	0	20,300	0	70,700	
2009	88,800	108,586	18,500	82,250	0	0	0	0	0	22,200	0	72,800	
2010	88,800	108,586	18,500	82,250	0	0	0	0	0	22,200	0	72,800	
2011	88,800	108,586	18,500	82,250	0	0	0	0	0	22,200	0	72,800	
2012	88,800	108,586	18,500	82,250	0	0	0	0	0	22,200	0	72,800	
2013	85,260	147,842	19,740	84,447	0	0	0	0	0	19,500	0	63,700	
2014	85,260	128,162	19,740	104,187	0	0	0	0	0	19,500	0	63,700	
2015	85,260	128,162	19,740	104,187	0	0	0	0	0	19,500	0	63,700	
2016	85,260	128,162	19,740	104,187	0	0	0	0	0	19,500	0	63,700	
2017	85,260	128,162	19,740	104,187	0	0	0	0	0	19,500	0	63,700	
2018	85,260	128,162	19,740	104,187	0	0	0	0	0	19,500	0	63,700	
2019	85,260	128,162	19,740	104,187	0	0	0	0	0	19,500	0	63,700	
2020	85,260	128,162	19,740	104,187	0	0	0	0	0	19,500	0	63,700	
2021	85,260	128,162	19,740	104,187	0	0	0	0	0	19,500	0	63,700	
2022	85,260	128,162	19,740	104,187	0	0	0	0	0	19,500	0	63,700	
2023	85,260	128,162	19,740	104,187	0	0	0	0	0	19,500	0	63,700	
2024	85,260	128,162	19,740	104,187	0	0	0	0	0	19,500	0	63,700	
2025	85,260	128,162	19,740	104,187	0	0	0	0	0	19,500	0	63,700	
2026	85,260	128,162	19,740	104,187	0	0	0	0	0	19,500	0	63,700	
2027	85,260	128,162	19,740	104,187	0	0	0	0	0	19,500	0	63,700	
2028	85,260	128,162	19,740	104,187	0	0	0	0	0	19,500	0	63,700	
2029	85,260	128,162	19,740	104,187	0	0	0	0	0	19,500	0	63,700	
2030	85,260	128,162	19,740	104,187	0	0	0	0	0	19,500	0	63,700	
2031	85,260	128,162	19,740	104,187	0	0	0	0	0	19,500	0	63,700	
2032	85,260	128,162	19,740	104,187	0	0	0	0	0	19,500	0	63,700	
2033	85,260	128,162	19,740	104,187	0	0	0	0	0	19,500	0	63,700	
2034	85,260	128,162	19,740	104,187	0	0	0	0	0	19,500	0	63,700	
2035	85,260	128,162	19,740	104,187	0	0	0	0	0	19,500	0	63,700	
TOTAL	4,175,368	6,836,753	878,076	4,648,529	2,408	9,014	7,557	30,847	3,500	24,474	1,283,098	3,714	3,946,322

**TABLE B-5A. Annual Water Quantities Delivered from Each Aqueduct Reach to Each Contractor**

(in acre-feet)

Sheet 10 of 16

Calendar Year	CALIFORNIA AQUEDUCT (continued)											
	SOUTH SAN JOAQUIN DIVISION								MOJAVE DIVISION			
	Reach 14C			Reach 15A		Reach 16A			Reach 18A	Reach 19		
	KCWA		MWDSC	KCWA		KCWA		AVEKWA	AVEKWA	MWA	AVEKWA	LCID
	(M&I)	(AG)		(M&I)	(AG)	(M&I)	(AG)					
[103]	[103]	[104]	[105]	[106]	[107]	[108]	[109]	[110]	[111]	[112]	[113]	
1962	0	0	0	0	0	0	0	0	0	0	0	0
1963	0	0	0	0	0	0	0	0	0	0	0	0
1964	0	0	0	0	0	0	0	0	0	0	0	0
1965	0	0	0	0	0	0	0	0	0	0	0	0
1966	0	0	0	0	0	0	0	0	0	0	0	0
1967	0	0	0	0	0	0	0	0	0	0	0	0
1968	0	0	0	0	0	0	0	0	0	0	0	0
1969	0	0	0	0	0	0	0	0	0	0	0	0
1970	0	0	0	0	0	0	0	0	0	0	0	0
1971	0	24,187	0	0	3,552	0	0	0	0	0	0	0
1972	0	35,016	0	0	6,064	0	4,768	0	0	0	0	0
1973	0	19,043	0	0	19,916	0	1,961	0	0	0	0	0
1974	0	12,601	0	0	18,000	3,000	1,564	0	0	0	1,223	0
1975	0	12,783	0	0	35,420	3,200	9,867	0	0	0	7,622	0
1976	0	9,005	0	0	39,551	3,500	11,667	0	3,808	0	23,063	0
1977	0	3,757	0	0	6,158	3,420	685	0	1,231	0	8,927	0
1978	0	24,542	0	0	31,148	7,989	1,655	0	1,321	0	36,333	0
1979	0	22,372	0	0	38,602	2,813	15,808	0	2,098	0	49,910	0
1980	0	19,953	0	0	37,817	2,700	16,145	0	2,610	0	61,534	0
1981	7	18,729	0	0	39,033	2,636	18,156	0	2,340	0	65,690	0
1982	0	26,479	0	0	47,782	1,921	16,577	0	1,669	0	41,127	0
1983	0	26,613	0	0	37,426	1,400	17,907	0	43	0	26,377	0
1984	2	34,996	0	0	49,848	1,338	24,246	0	90	0	22,462	0
1985	0	31,758	0	0	44,078	1,309	16,820	0	8	0	23,440	0
1986	0	34,566	0	0	42,461	1,213	15,559	0	8	0	16,898	0
1987	10	31,019	0	0	34,748	1,665	10,170	0	0	0	15,958	0
1988	1	37,165	0	16	41,978	1,925	8,987	0	0	0	13,471	0
1989	5	37,800	0	2	43,239	2,668	8,649	0	0	0	18,007	0
1990	9	34,174	0	6	36,347	2,819	8,608	0	0	0	17,281	0
1991	0	0	0	0	0	2,588	343	2,000	0	0	728	0
1992	0	18,084	0	0	24,243	2,087	8,275	0	0	0	7,238	0
1993	0	28,103	0	0	27,997	2,494	9,167	0	0	0	13,340	0
1994	1,000	22,624	0	0	29,511	3,011	13,877	0	0	0	19,122	0
1995	0	31,285	0	0	26,134	3,188	15,042	0	0	0	20,222	0
1996	0	38,879	0	0	36,186	2,573	18,142	0	0	0	23,919	0
1997	0	33,512	0	0	36,281	3,997	17,048	0	0	64	28,834	0
1998	0	23,097	0	0	28,712	3,751	17,032	0	0	1,345	22,466	0
1999	0	31,489	0	0	36,801	3,316	24,071	0	0	1,439	30,944	0
2000	0	33,716	0	0	40,063	3,015	20,919	0	0	1,361	34,786	0
2001	0	23,557	0	0	31,192	1,894	13,476	0	0	1,385	24,370	0
2002	0	27,138	0	0	41,552	4,227	14,520	0	0	1,370	14,297	0
2003	0	24,783	12,911	0	36,602	1,168	16,799	0	0	1,285	12,145	0
2004	0	30,313	0	0	40,184	2,239	19,714	0	0	1,223	11,201	0
2005	0	21,979	0	0	39,870	167	18,353	0	11	1,051	11,804	0
2006	1,413	20,193	5,440	0	46,244	279	22,570	0	2,063	1,021	16,375	0
2007	0	24,947	1,881	0	47,390	204	26,229	0	0	1,176	22,472	444
2008	0	27,800	0	0	51,800	3,620	0	0	0	1,385	17,126	0
2009	0	29,500	0	0	53,000	3,790	0	0	0	1,385	17,116	0
2010	0	29,500	0	0	53,000	3,790	3,790	0	0	1,385	17,068	0
2011	0	29,500	0	0	53,000	3,790	0	0	0	1,385	17,878	0
2012	0	29,500	0	0	53,000	3,790	0	0	0	1,385	18,104	0
2013	0	24,500	0	0	49,700	23,100	3,560	0	0	1,235	14,101	0
2014	0	24,500	0	0	49,700	23,100	3,500	0	0	1,235	14,101	0
2015	0	24,500	0	0	49,700	23,100	3,500	0	0	1,235	14,101	0
2016	0	24,500	0	0	49,700	23,100	3,500	0	0	1,235	14,101	0
2017	0	24,500	0	0	49,700	23,100	3,500	0	0	1,235	14,101	0
2018	0	24,500	0	0	49,700	23,100	3,500	0	0	1,235	14,101	0
2019	0	24,500	0	0	49,700	23,100	3,500	0	0	1,235	14,101	0
2020	0	24,500	0	0	49,700	23,100	3,500	0	0	1,235	14,101	0
2021	0	24,500	0	0	49,700	23,100	3,500	0	0	1,235	14,101	0
2022	0	24,500	0	0	49,700	23,100	3,500	0	0	1,235	14,101	0
2023	0	24,500	0	0	49,700	23,100	3,500	0	0	1,235	14,101	0
2024	0	24,500	0	0	49,700	23,100	3,500	0	0	1,235	14,101	0
2025	0	24,500	0	0	49,700	23,100	3,500	0	0	1,235	14,101	0
2026	0	24,500	0	0	49,700	23,100	3,500	0	0	1,235	14,101	0
2027	0	24,500	0	0	49,700	23,100	3,500	0	0	1,235	14,101	0
2028	0	24,500	0	0	49,700	23,100	3,500	0	0	1,235	14,101	0
2029	0	24,500	0	0	49,700	23,100	3,500	0	0	1,235	14,101	0
2030	0	24,500	0	0	49,700	23,100	3,500	0	0	1,235	14,101	0
2031	0	24,500	0	0	49,700	23,100	3,500	0	0	1,235	14,101	0
2032	0	24,500	0	0	49,700	23,100	3,500	0	0	1,235	14,101	0
2033	0	24,500	0	0	49,700	23,100	3,500	0	0	1,235	14,101	0
2034	0	24,500	0	0	49,700	23,100	3,500	0	0	1,235	14,101	0
2035	0	24,500	0	0	49,700	23,100	3,500	0	0	1,235	14,101	0
TOTAL	2,447	1,639,557	20,232	24	2,629,030	635,794	569,726	2,000	17,300	48,050	1,175,201	444

**TABLE B-5A. Annual Water Quantities Delivered from Each Aqueduct Reach to Each Contractor**

(in acre-feet)

Sheet 11 of 16

Calendar  Year	CALIFORNIA AQUEDUCT (continued)										
	MOJAVE DIVISION (continued)										
	Reach 20A			Reach 20B		Reach 21			Reach 22A		Reach 22B
	PWD	MWA	AVEKWA	PWD	AVEKWA	LCID	PWD	AVEKWA	AVEKWA	LCID	MWDSC(d)
[114]	[115]	[116]	[117]	[118]	[119]	[120]	[121]	[122]	[123]	[124]	
1962	0	0	0	0	0	0	0	0	0	0	
1963	0	0	0	0	0	0	0	0	0	0	
1964	0	0	0	0	0	0	0	0	0	0	
1965	0	0	0	0	0	0	0	0	0	0	
1966	0	0	0	0	0	0	0	0	0	0	
1967	0	0	0	0	0	0	0	0	0	0	
1968	0	0	0	0	0	0	0	0	0	0	
1969	0	0	0	0	0	0	0	0	0	0	
1970	0	0	0	0	0	0	0	0	0	0	
1971	0	0	0	0	0	0	0	0	0	0	
1972	0	0	0	0	0	338	0	0	0	0	
1973	0	0	0	0	0	290	0	0	0	(14,800)	
1974	0	0	0	0	0	400	0	0	0	(16,400)	
1975	0	0	420	0	0	520	0	0	0	(18,000)	
1976	0	0	471	0	416	589	0	0	0	(19,600)	
1977	0	0	773	0	271	111	0	0	0	0	
1978	0	0	5,549	0	934	208	0	0	0	(25,384)	
1979	0	0	7,555	0	930	133	0	0	0	(25,063)	
1980	0	0	7,605	0	655	191	0	3	0	(27,884)	
1981	0	0	10,333	0	966	1,270	0	46	0	(31,105)	
1982	0	0	7,313	0	8	0	0	174	0	(34,326)	
1983	0	0	6,253	0	20	38	0	268	0	(37,547)	
1984	0	0	9,558	0	2	1	0	550	0	(40,768)	
1985	1,510	0	11,613	32	217	0	16	1,786	0	(43,989)	
1986	3,041	0	13,808	45	0	163	10	1,735	0	(47,210)	
1987	2,389	0	15,493	1,624	151	1,080	1,366	2,273	5	(50,931)	
1988	366	0	17,117	1,261	281	419	143	3,210	0	(54,652)	
1989	381	0	23,481	7,848	112	971	780	3,591	0	(58,373)	
1990	282	0	25,843	8,292	84	1,747	34	3,988	0	(61,200)	
1991	84	1,391	4,282	3,830	131	522	0	2,427	0	(18,360)	
1992	185	1,310	18,518	3,850	650	251	0	3,859	0	(27,624)	
1993	164	1,514	23,662	7,597	996	734	0	5,098	0	0	
1994	299	1,399	25,250	8,119	124	1,098	0	4,657	0	0	
1995	328	1,227	22,385	6,633	0	480	0	4,679	0	0	
1996	354	1,316	26,979	11,080	0	494	0	5,458	0	0	
1997	313	1,272	27,999	11,548	0	444	0	5,549	0	0	
1998	196	0	25,985	8,557	0	404	0	4,468	0	0	
1999	377	0	32,409	12,901	36	342	0	5,684	0	0	
2000	0	0	37,819	9,060	80	0	0	5,890	0	0	
2001	0	0	33,216	10,427	282	0	0	4,989	0	0	
2002	0	0	36,311	18,496	1,662	0	0	5,404	0	0	
2003	0	0	39,532	11,547	2,299	0	0	6,063	0	0	
2004	0	0	40,408	12,139	1,774	0	23	6,995	0	0	
2005	0	0	41,496	11,678	1,336	0	34	5,184	0	5,942	
2006	0	0	53,878	12,487	1,415	0	5	6,653	0	0	
2007	0	0	46,703	19,609	1,349	936	25	7,711	0	0	
2008	300	0	45,804	19,000	1,545	2,300	0	6,225	0	0	
2009	0	0	45,814	21,300	1,545	2,300	0	6,225	0	0	
2010	0	0	45,891	21,300	1,539	2,300	0	6,202	0	0	
2011	0	0	47,006	21,300	1,584	2,300	0	6,388	0	0	
2012	0	0	48,418	21,300	1,634	2,300	0	6,580	0	0	
2013	0	0	48,724	21,300	1,925	2,300	0	5,950	0	0	
2014	0	0	119,424	21,300	1,925	2,300	0	5,950	0	0	
2015	0	0	119,424	21,300	1,925	2,300	0	5,950	0	0	
2016	0	0	119,424	21,300	1,925	2,300	0	5,950	0	0	
2017	0	0	119,424	21,300	1,925	2,300	0	5,950	0	0	
2018	0	0	119,424	21,300	1,925	2,300	0	5,950	0	0	
2019	0	0	119,424	21,300	1,925	2,300	0	5,950	0	0	
2020	0	0	119,424	21,300	1,925	2,300	0	5,950	0	0	
2021	0	0	119,424	21,300	1,925	2,300	0	5,950	0	0	
2022	0	0	119,424	21,300	1,925	2,300	0	5,950	0	0	
2023	0	0	119,424	21,300	1,925	2,300	0	5,950	0	0	
2024	0	0	119,424	21,300	1,925	2,300	0	5,950	0	0	
2025	0	0	119,424	21,300	1,925	2,300	0	5,950	0	0	
2026	0	0	119,424	21,300	1,925	2,300	0	5,950	0	0	
2027	0	0	119,424	21,300	1,925	2,300	0	5,950	0	0	
2028	0	0	119,424	21,300	1,925	2,300	0	5,950	0	0	
2029	0	0	119,424	21,300	1,925	2,300	0	5,950	0	0	
2030	0	0	119,424	21,300	1,925	2,300	0	5,950	0	0	
2031	0	0	119,424	21,300	1,925	2,300	0	5,950	0	0	
2032	0	0	119,424	21,300	1,925	2,300	0	5,950	0	0	
2033	0	0	119,424	21,300	1,925	2,300	0	5,950	0	0	
2034	0	0	119,424	21,300	1,925	2,300	0	5,950	0	0	
2035	0	0	119,424	21,300	1,925	2,300	0	5,950	0	0	
<b>TOTAL</b>	<b>10,568</b>	<b>9,429</b>	<b>3,609,002</b>	<b>792,760</b>	<b>69,293</b>	<b>78,574</b>	<b>2,436</b>	<b>5,002</b>	<b>275,962</b>	<b>5</b>	<b>(647,274)</b>

d) In accordance with the Exchange Agreement between the noted agencies, MWDSC assumed responsibility for payment of variable OMP&R costs on the exchange water in reaches beyond Reach 22B, and Desert Water Agency and Coachella Valley Water District for such costs from the Delta through Reach 22B.  
The adjustment in deliveries in Reach 22B provides for compliance with provisions for the repayment of costs under the agreement. In 1993 and after the exchange takes place in Reach 26A.

**TABLE B-5A. Annual Water Quantities Delivered from Each Aqueduct Reach to Each Contractor**

(in acre-feet)

Sheet 12 of 16

Calendar Year	CALIFORNIA AQUEDUCT (continued)										
	MOJAVE DIVISION (continued)									SANTA ANA DIVISION	
	Reach 22B				Reach 23	Reach 24				Reach 26A	
	MWA	CVWD(e)	DWA(e)	AVEKWA(f)	MWA	CLAWA	MWA	MWDSC(e)	SBVMWD	MWDSC(e)	SBVMWD(g)
[125]	[126]	[127]	[128]	[129]	[130]	[131]	[132]	[133]	[134]	[135]	
1962	0	0	0	0	0	0	0	0	0	0	0
1963	0	0	0	0	0	0	0	0	0	0	0
1964	0	0	0	0	0	0	0	0	0	0	0
1965	0	0	0	0	0	0	0	0	0	0	0
1966	0	0	0	0	0	0	0	0	0	0	0
1967	0	0	0	0	0	0	0	0	0	0	0
1968	0	0	0	0	0	0	0	0	0	0	0
1969	0	0	0	0	0	0	0	0	0	0	0
1970	0	0	0	0	0	0	0	0	0	0	0
1971	0	0	0	0	0	0	0	0	0	0	0
1972	55	0	0	0	0	464	0	0	0	0	1,275
1973	0	5,800	9,000	0	0	389	0	0	444	0	32,426
1974	0	6,400	10,000	0	14	627	0	0	84,981	0	16,605
1975	0	7,000	11,000	0	0	825	0	0	169,960	0	13,865
1976	0	7,600	12,000	0	0	1,002	0	0	215,312	0	12,273
1977	22	0	0	0	58	1,109	0	0	64,823	0	24,833
1978	0	10,084	15,300	0	0	1,209	0	0	297,708	0	4,055
1979	4,000	10,063	15,000	0	0	1,260	0	0	260,903	0	18
1980	4,000	10,884	17,000	0	0	1,239	0	0	300,345	0	0
1981	4,000	12,105	19,000	0	0	1,485	0	0	395,678	0	16,021
1982	10,500	13,326	21,000	0	0	1,238	0	0	214,566	0	8,409
1983	0	14,547	23,000	0	0	911	0	0	175,288	0	5,994
1984	0	15,768	25,000	0	0	1,128	0	0	122,311	0	5,556
1985	0	16,989	27,000	0	0	1,422	0	0	147,599	0	7,390
1986	0	18,210	29,000	0	0	1,506	0	0	215,265	0	6,421
1987	17	19,431	31,500	214	0	1,849	0	0	175,012	0	18,751
1988	9	20,652	34,000	0	0	2,006	0	0	247,101	0	21,386
1989	0	21,873	36,500	89	200	2,170	0	0	326,217	0	20,782
1990	0	23,100	38,100	10	0	1,827	0	0	399,387	0	18,831
1991	0	6,930	11,430	0	0	849	2,032	0	107,182	0	3,661
1992	42	10,427	17,197	0	0	519	9,334	0	219,524	0	3,358
1993	0	0	0	0	0	439	10,000	0	98,291	0	4,361
1994	14,634	0	0	0	0	785	819	0	192,979	0	9,135
1995	7,495	0	0	0	0	409	0	0	107,299	0	696
1996	6,111	0	0	0	0	485	0	0	73,438	0	6,064
1997	9,038	0	0	0	0	651	0	0	157,215	0	9,654
1998	2,580	0	0	0	0	187	0	0	36,770	0	1,878
1999	6,705	0	0	0	0	1,132	0	0	139,752	0	12,874
2000	10,019	0	0	0	0	1,194	0	0	326,647	0	18,399
2001	3,048	0	0	0	0	1,057	0	0	284,007	0	26,488
2002	2,976	0	0	497	0	2,189	0	0	303,127	0	63,468
2003	13,150	0	0	0	0	1,563	0	17,249	532,198	0	27,415
2004	11,953	0	0	253	0	2,006	0	0	548,854	0	56,150
2005	12,169	0	0	0	0	205	341	14,058	515,676	0	33,977
2006	32,993	0	0	0	0	641	0	0	404,594	0	20,000
2007	18,933	0	0	588	0	1,768	0	710	370,971	0	10,022
2008	40,500	0	0	0	0	3,160	0	0	600	0	0
2009	36,515	0	0	0	0	3,340	0	0	600	0	0
2010	36,515	0	0	0	0	3,460	0	0	600	0	0
2011	36,515	0	0	0	0	3,600	0	0	600	0	0
2012	36,515	0	0	0	0	3,720	0	0	600	0	0
2013	39,375	0	0	0	0	3,720	0	0	600	0	0
2014	74,565	0	0	0	0	5,800	0	0	600	0	0
2015	74,565	0	0	0	0	5,800	0	0	600	0	0
2016	74,565	0	0	0	0	5,800	0	0	600	0	0
2017	74,565	0	0	0	0	5,800	0	0	600	0	0
2018	74,565	0	0	0	0	5,800	0	0	600	0	0
2019	74,565	0	0	0	0	5,800	0	0	600	0	0
2020	74,565	0	0	0	0	5,800	0	0	600	0	0
2021	74,565	0	0	0	0	5,800	0	0	600	0	0
2022	74,565	0	0	0	0	5,800	0	0	600	0	0
2023	74,565	0	0	0	0	5,800	0	0	600	0	0
2024	74,565	0	0	0	0	5,800	0	0	600	0	0
2025	74,565	0	0	0	0	5,800	0	0	600	0	0
2026	74,565	0	0	0	0	5,800	0	0	600	0	0
2027	74,565	0	0	0	0	5,800	0	0	600	0	0
2028	74,565	0	0	0	0	5,800	0	0	600	0	0
2029	74,565	0	0	0	0	5,800	0	0	600	0	0
2030	74,565	0	0	0	0	5,800	0	0	600	0	0
2031	74,565	0	0	0	0	5,800	0	0	600	0	0
2032	74,565	0	0	0	0	5,800	0	0	600	0	0
2033	74,565	0	0	0	0	5,800	0	0	600	0	0
2034	74,565	0	0	0	0	5,800	0	0	600	0	0
2035	74,565	0	0	0	0	5,800	0	0	600	0	0
<b>TOTAL</b>	<b>2,040,814</b>	<b>251,189</b>	<b>402,027</b>	<b>1,651</b>	<b>272</b>	<b>188,345</b>	<b>22,526</b>	<b>31,307</b>	<b>17,510</b>	<b>8,231,224</b>	<b>542,491</b>

e) In accordance with the Exchange Agreement between the noted agencies, MWDSC assumed responsibility for payment of variable OMP&R costs on the exchange water in reaches beyond Reach 22B, and Desert Water Agency and Coachella Valley Water District for such costs from the Delta through Reach 22B. The adjustment in deliveries in Reach 22B provides for compliance with provisions for the repayment of costs under the agreement. In 1993 and after the exchange takes place in Reach 26A.

f) 1988 advance allocation.

g.) Includes 1,650 AF recaptured from ground water storage in 1982, 10,000 AF in 1987, and 8,749 AF in 1988. This was water stored under DWR's Ground Water Demonstration Program.

**TABLE B-5A. Annual Water Quantities Delivered from Each Aqueduct Reach to Each Contractor**

(in acre-feet)

Sheet 13 of 16

Calendar Year	CALIFORNIA AQUEDUCT (continued)										
	SANTA ANA DIVISION (continued)										
	Reach 26A				Reach 28G	Reach 28H			Reach 28J		
	SGVMWD	SGPWA	CVWD(e)	DWA(e)	MWDSC	CVWD	DWA	MWDSC	CVWD	DWA	MWDSC
[136]	[137]	[138]	[139]	[140]	[141]	[142]	[143]	[144]	[145]	[146]	
1962	0	0	0	0	0	0	0	0	0	0	0
1963	0	0	0	0	0	0	0	0	0	0	0
1964	0	0	0	0	0	0	0	0	0	0	0
1965	0	0	0	0	0	0	0	0	0	0	0
1966	0	0	0	0	0	0	0	0	0	0	0
1967	0	0	0	0	0	0	0	0	0	0	0
1968	0	0	0	0	0	0	0	0	0	0	0
1969	0	0	0	0	0	0	0	0	0	0	0
1970	0	0	0	0	0	0	0	0	0	0	0
1971	0	0	0	0	0	0	0	0	0	0	0
1972	0	0	0	0	0	0	0	0	0	0	0
1973	0	0	0	0	18,942	0	0	0	0	0	0
1974	612	0	0	0	0	0	0	0	0	0	0
1975	5,450	0	0	0	0	0	0	0	0	0	251
1976	6,071	0	0	0	0	0	0	55	0	0	2,000
1977	8,996	0	0	0	0	0	0	43	0	0	2,442
1978	7,771	0	0	0	0	0	0	48	0	0	64,054
1979	290	0	0	0	0	0	0	1,290	0	0	94,353
1980	1,085	0	0	0	0	0	0	3,013	0	0	91,532
1981	3,619	0	0	0	0	0	0	4,365	0	0	149,405
1982	12,599	0	0	0	0	0	0	3,961	0	0	155,629
1983	734	0	0	0	0	0	0	6,645	0	0	41,616
1984	7,656	0	0	0	0	0	0	109,743	0	0	5,672
1985	5,028	0	0	0	0	0	0	182,781	0	0	6,538
1986	9,454	0	0	0	0	0	0	131,439	0	0	30,071
1987	10,630	0	0	0	0	0	0	144,743	0	0	26,315
1988	8,948	0	0	0	0	0	0	199,641	0	0	22,209
1989	12,839	0	0	0	0	0	0	247,430	0	0	51,462
1990	16,649	0	0	0	0	0	0	257,796	0	0	36,060
1991	5,399	0	0	0	0	0	0	38,832	0	0	5,958
1992	7,908	0	0	0	0	0	0	85,341	0	0	12,223
1993	14,397	0	23,100	38,100	0	0	0	61,841	0	0	4,588
1994	15,230	0	14,102	23,257	0	0	0	134,262	0	0	4,725
1995	12,922	0	23,100	38,100	0	0	0	117,762	0	0	21,099
1996	15,989	0	62,219	102,622	0	0	0	144,906	0	0	12,418
1997	18,175	0	58,100	53,100	0	0	0	107,853	0	0	47,777
1998	9,310	0	78,100	58,100	0	6,582	7,708	77,473	1,027	4,839	50,411
1999	21,729	0	50,480	58,100	0	0	0	206,689	0	0	8,163
2000	15,140	0	42,323	58,234	0	0	0	379,713	0	0	7,864
2001	2,360	0	9,100	15,010	0	0	0	260,984	0	0	33,414
2002	24,851	0	16,755	27,640	0	0	0	340,635	0	0	41,552
2003	21,934	116	14,443	23,819	0	0	0	246,485	0	0	50,776
2004	12,541	841	15,465	21,190	0	0	0	357,995	0	0	20,437
2005	13,984	692	42,519	49,089	0	0	0	242,245	0	0	114,499
2006	16,284	0	121,100	50,000	0	0	0	342,734	0	0	32,242
2007	10,000	0	66,007	27,253	0	7,221	2,981	271,874	0	0	48,923
2008	28,800	0	84,770	35,000	0	0	0	102,710	0	0	299,197
2009	28,800	0	121,100	50,000	0	0	0	102,710	0	0	299,197
2010	28,800	0	138,350	50,000	0	0	0	102,710	0	0	299,197
2011	28,800	0	138,350	50,000	0	0	0	102,710	0	0	299,197
2012	28,800	0	138,350	50,000	0	0	0	102,710	0	0	299,197
2013	28,800	0	138,350	50,000	0	0	0	81,110	0	0	248,457
2014	28,800	0	138,350	50,000	0	0	0	81,110	0	0	248,457
2015	28,800	0	138,350	50,000	0	0	0	81,110	0	0	248,457
2016	28,800	0	138,350	50,000	0	0	0	81,110	0	0	248,457
2017	28,800	0	138,350	50,000	0	0	0	81,110	0	0	248,457
2018	28,800	0	138,350	50,000	0	0	0	81,110	0	0	248,457
2019	28,800	0	138,350	50,000	0	0	0	81,110	0	0	248,457
2020	28,800	0	138,350	50,000	0	0	0	81,110	0	0	248,457
2021	28,800	0	138,350	50,000	0	0	0	81,110	0	0	248,457
2022	28,800	0	138,350	50,000	0	0	0	81,110	0	0	248,457
2023	28,800	0	138,350	50,000	0	0	0	81,110	0	0	248,457
2024	28,800	0	138,350	50,000	0	0	0	81,110	0	0	248,457
2025	28,800	0	138,350	50,000	0	0	0	81,110	0	0	248,457
2026	28,800	0	138,350	50,000	0	0	0	81,110	0	0	248,457
2027	28,800	0	138,350	50,000	0	0	0	81,110	0	0	248,457
2028	28,800	0	138,350	50,000	0	0	0	81,110	0	0	248,457
2029	28,800	0	138,350	50,000	0	0	0	81,110	0	0	248,457
2030	28,800	0	138,350	50,000	0	0	0	81,110	0	0	248,457
2031	28,800	0	138,350	50,000	0	0	0	81,110	0	0	248,457
2032	28,800	0	138,350	50,000	0	0	0	81,110	0	0	248,457
2033	28,800	0	138,350	50,000	0	0	0	81,110	0	0	248,457
2034	28,800	0	138,350	50,000	0	0	0	81,110	0	0	248,457
2035	28,800	0	138,350	50,000	0	0	0	81,110	0	0	248,457
TOTAL	1,162,984	1,649	4,439,883	2,028,614	18,942	13,803	10,689	7,089,697	1,027	4,839	8,507,174



**TABLE B-5A. Annual Water Quantities Delivered from Each Aqueduct Reach to Each Contractor**

(in acre-feet)

Sheet 14 of 16

Calendar Year	CALIFORNIA AQUEDUCT (continued)				
	SANTA ANA DIVISION (continued)				
	Reach EBX1		Reach EBX2C	Reach EBX3A	Reach EBX4B
	MWDSC	SBVMWD	SBVMWD	SBVMWD	SGVMWD
	[148]	[149]	[150]	[151]	[152]
1962	0	0	0	0	0
1963	0	0	0	0	0
1964	0	0	0	0	0
1965	0	0	0	0	0
1966	0	0	0	0	0
1967	0	0	0	0	0
1968	0	0	0	0	0
1969	0	0	0	0	0
1970	0	0	0	0	0
1971	0	0	0	0	0
1972	0	0	0	0	0
1973	0	0	0	0	0
1974	0	0	0	0	0
1975	0	0	0	0	0
1976	0	0	0	0	0
1977	0	0	0	0	0
1978	0	0	0	0	0
1979	0	0	0	0	0
1980	0	0	0	0	0
1981	0	0	0	0	0
1982	0	0	0	0	0
1983	0	0	0	0	0
1984	0	0	0	0	0
1985	0	0	0	0	0
1986	0	0	0	0	0
1987	0	0	0	0	0
1988	0	0	0	0	0
1989	0	0	0	0	0
1990	0	0	0	0	0
1991	0	0	0	0	0
1992	0	0	0	0	0
1993	0	0	0	0	0
1994	0	0	0	0	0
1995	0	0	0	0	0
1996	0	0	0	0	0
1997	0	0	0	0	0
1998	0	0	0	0	0
1999	0	0	0	0	0
2000	0	0	0	0	0
2001	0	0	0	0	0
2002	0	0	0	0	0
2003	0	0	0	0	0
2004	0	0	0	0	0
2005	0	0	0	0	0
2006	147,432	11,832	885	2,614	4,278
2007	94,208	38,151	3,130	2,172	4,008
2008	604,230	102,000	0	0	17,300
2009	501,570	102,000	0	0	17,300
2010	452,150	102,000	0	0	17,300
2011	452,150	102,000	0	0	17,300
2012	452,150	102,000	0	0	17,300
2013	446,777	102,000	0	0	17,300
2014	446,777	102,000	0	0	17,300
2015	446,777	102,000	0	0	17,300
2016	446,777	102,000	0	0	17,300
2017	446,777	102,000	0	0	17,300
2018	446,777	102,000	0	0	17,300
2019	446,777	102,000	0	0	17,300
2020	446,777	102,000	0	0	17,300
2021	446,777	102,000	0	0	17,300
2022	446,777	102,000	0	0	17,300
2023	446,777	102,000	0	0	17,300
2024	446,777	102,000	0	0	17,300
2025	446,777	102,000	0	0	17,300
2026	446,777	102,000	0	0	17,300
2027	446,777	102,000	0	0	17,300
2028	446,777	102,000	0	0	17,300
2029	446,777	102,000	0	0	17,300
2030	446,777	102,000	0	0	17,300
2031	446,777	102,000	0	0	17,300
2032	446,777	102,000	0	0	17,300
2033	446,777	102,000	0	0	17,300
2034	446,777	102,000	0	0	17,300
2035	446,777	102,000	0	0	17,300
TOTAL	12,979,761	2,905,983	4,015	4,786	492,687

**TABLE B-5A. Annual Water Quantities Delivered from Each Aqueduct Reach to Each Contractor**

(in acre-feet)

Sheet 15 of 16

Calendar Year	CALIFORNIA AQUEDUCT (continued)									
	WEST BRANCH									
	Reach 29F	Reach 29H	Reach 30							SBC
	AVEKWA	VCFCD	CVWD	DWA	MWDSC(h)	VCFCD	SBVMWD	CLWA	FC&WCD	
[153]	[154]	[155]	[156]	[157]	[158]	[159]	[160]	[161]		
1962	0	0	0	0	0	0	0	0	0	
1963	0	0	0	0	0	0	0	0	0	
1964	0	0	0	0	0	0	0	0	0	
1965	0	0	0	0	0	0	0	0	0	
1966	0	0	0	0	0	0	0	0	0	
1967	0	0	0	0	0	0	0	0	0	
1968	0	0	0	0	0	0	0	0	0	
1969	0	0	0	0	0	0	0	0	0	
1970	0	0	0	0	0	0	0	0	0	
1971	0	0	0	0	0	0	0	0	0	
1972	53	0	0	0	71,938	0	0	0	0	
1973	20	0	0	0	155,297	0	0	0	0	
1974	36	0	0	0	209,136	0	0	0	0	
1975	26	0	0	0	374,280	0	0	0	0	
1976	24	0	0	0	420,684	0	0	0	0	
1977	0	0	0	0	122,447	0	0	0	0	
1978	0	0	0	0	171,139	0	0	0	0	
1979	0	0	0	0	145,591	0	0	7	0	
1980	0	0	0	0	164,721	0	0	1,210	0	
1981	0	0	0	0	277,503	0	0	5,761	0	
1982	0	0	0	0	351,362	0	0	9,516	0	
1983	0	0	0	0	157,519	0	0	9,476	0	
1984	0	0	0	0	260,624	0	0	11,477	0	
1985	0	0	0	0	390,696	0	0	12,401	0	
1986	0	0	0	0	379,275	0	0	13,928	0	
1987	0	0	0	0	417,285	0	0	16,167	0	
1988	0	0	0	0	488,265	0	0	18,904	0	
1989	0	0	0	0	589,962	0	0	21,719	0	
1990	0	4,836	0	0	764,380	0	0	22,139	0	
1991	0	988	0	0	257,835	0	0	3,846	1,240	
1992	0	0	0	0	420,849	0	0	14,812	0	
1993	6	0	0	0	437,470	0	0	13,787	0	
1994	0	0	0	0	475,900	0	0	14,919	0	
1995	0	0	0	0	139,882	0	0	17,747	0	
1996	0	0	0	0	267,618	0	0	18,448	0	
1997	11	0	10,240	16,890	271,379	1,850	0	22,842	0	
1998	7	0	0	0	187,277	1,850	0	19,782	0	
1999	0	0	0	0	327,001	1,850	0	28,813	0	
2000	0	2,200	0	0	632,991	1,850	0	31,085	0	
2001	0	0	0	0	444,764	1,850	0	30,701	0	
2002	0	3,148	0	0	723,605	1,850	8,601	42,080	0	
2003	0	3,150	0	0	678,964	1,850	0	51,735	0	
2004	0	4,047	0	0	797,294	1,203	0	47,463	0	
2005	0	0	0	0	538,839	1,665	0	36,747	0	
2006	0	0	0	0	574,679	1,850	0	40,017	0	
2007	0	1,890	0	0	711,831	1,110	0	45,919	0	
2008	0	3,150	0	0	756,693	16,850	0	27,600	0	
2009	0	3,150	0	0	639,723	16,850	0	37,000	0	
2010	0	3,150	0	0	671,893	16,850	0	39,000	0	
2011	0	3,150	0	0	671,893	16,850	0	40,000	0	
2012	0	3,150	0	0	671,893	16,850	0	42,000	0	
2013	0	3,150	0	0	687,474	16,850	0	50,000	0	
2014	0	3,150	0	0	887,474	16,850	0	89,200	0	
2015	0	3,150	0	0	887,474	16,850	0	89,200	0	
2016	0	3,150	0	0	887,474	16,850	0	89,200	0	
2017	0	3,150	0	0	887,474	16,850	0	89,200	0	
2018	0	3,150	0	0	887,474	16,850	0	89,200	0	
2019	0	3,150	0	0	887,474	16,850	0	89,200	0	
2020	0	3,150	0	0	887,474	16,850	0	89,200	0	
2021	0	3,150	0	0	887,474	16,850	0	89,200	0	
2022	0	3,150	0	0	887,474	16,850	0	89,200	0	
2023	0	3,150	0	0	887,474	16,850	0	89,200	0	
2024	0	3,150	0	0	887,474	16,850	0	89,200	0	
2025	0	3,150	0	0	887,474	16,850	0	89,200	0	
2026	0	3,150	0	0	887,474	16,850	0	89,200	0	
2027	0	3,150	0	0	887,474	16,850	0	89,200	0	
2028	0	3,150	0	0	887,474	16,850	0	89,200	0	
2029	0	3,150	0	0	887,474	16,850	0	89,200	0	
2030	0	3,150	0	0	887,474	16,850	0	89,200	0	
2031	0	3,150	0	0	887,474	16,850	0	89,200	0	
2032	0	3,150	0	0	887,474	16,850	0	89,200	0	
2033	0	3,150	0	0	887,474	16,850	0	89,200	0	
2034	0	3,150	0	0	887,474	16,850	0	89,200	0	
2035	0	3,150	0	0	887,474	16,850	0	89,200	0	
TOTAL	183	108,459	10,240	16,890	37,424,279	490,578	8,601	2,821,448	1,240	

h) Deliveries exclude 6,171 AF of 1982 exchange water.

**TABLE B-5A. Annual Water Quantities Delivered from Each Aqueduct Reach to Each Contractor**

(in acre-feet)

Sheet 16 of 16

Calendar Year	CALIFORNIA AQUEDUCT (continued)								TOTAL	GRAND TOTAL
	COASTAL BRANCH									
	Reach 31A				Reach 33A					
	DRWD	CK	KCWA		CLWA	MWDSC	SLOC FC&WCD	SBC FC&WCD		
(M&I)			(AG)							
	[162]	[163]	[164]	[165]	[166]		[167]	[168]	[169]	[170]
1962	0	0	0	0	0	0	0	0	0	8,906
1963	0	0	0	0	0	0	0	0	0	12,645
1964	0	0	0	0	0	0	0	0	0	20,911
1965	0	0	0	0	0	0	0	0	0	34,026
1966	0	0	0	0	0	0	0	0	0	54,913
1967	0	0	0	0	0	0	0	0	0	56,763
1968	0	0	0	0	71,657	7,382	0	0	192,188	294,457
1969	0	0	0	0	52,094	9,970	0	0	195,705	268,104
1970	0	0	0	0	71,910	11,739	0	0	276,211	369,459
1971	0	0	0	0	98,481	12,490	0	0	553,081	654,250
1972	0	0	0	0	107,850	13,905	0	0	895,006	1,037,584
1973	0	0	0	0	69,227	9,418	0	0	638,930	737,479
1974	0	0	0	0	68,474	9,700	0	0	783,984	878,820
1975	0	0	0	0	74,516	10,700	0	0	1,129,728	1,230,577
1976	0	0	0	0	78,358	11,700	0	0	1,245,662	1,379,597
1977	0	0	0	0	35,504	5,075	0	0	465,442	581,675
1978	0	0	0	0	81,242	11,362	0	0	1,339,268	1,458,154
1979	0	0	0	0	104,017	19,138	0	0	1,537,075	1,666,155
1980	0	0	0	0	97,497	13,882	0	0	1,413,363	1,536,189
1981	0	0	0	0	97,054	12,700	0	0	1,779,479	1,918,342
1982	0	0	0	0	83,076	12,700	0	0	1,641,571	1,750,528
1983	0	0	0	0	87,859	12,659	0	0	1,089,626	1,186,831
1984	0	0	0	0	119,098	12,741	0	0	1,489,814	1,591,131
1985	0	0	0	0	110,124	12,099	0	0	1,863,544	1,989,925
1986	0	0	0	0	118,298	13,301	0	0	1,882,290	1,998,514
1987	0	0	0	0	116,259	11,821	0	0	1,984,570	2,131,061
1988	0	0	0	0	109,435	11,534	0	0	2,221,538	2,384,434
1989	0	0	0	0	102,156	14,645	0	0	2,686,838	2,853,044
1990	0	0	0	0	103,362	6,440	0	0	2,398,121	2,581,277
1991	0	0	0	0	780	716	0	0	489,489	548,520
1992	0	0	0	0	73,748	5,887	0	0	1,374,775	1,470,695
1993	0	0	0	0	90,764	4,157	0	0	2,173,352	2,314,233
1994	0	0	200	0	77,536	9,422	0	0	1,727,504	1,860,612
1995	0	0	0	0	85,050	9,486	0	0	1,926,835	2,030,310
1996	0	0	0	0	100,578	14,052	0	0	2,429,928	2,542,395
1997	0	0	0	0	97,920	4,870	0	1,099	2,263,966	2,404,254
1998	0	0	0	0	86,879	3,111	0	7,439	1,657,381	1,763,882
1999	0	0	0	0	92,095	4,086	0	3,743	2,755,025	2,897,579
2000	0	0	0	0	87,554	8,395	5,662	0	3,360,734	3,538,240
2001	0	0	0	0	63,448	1,238	0	4,283	2,033,996	2,173,262
2002	0	0	0	0	65,055	2,737	0	4,355	2,742,315	2,911,327
2003	0	0	0	0	65,691	4,001	0	4,453	3,136,285	3,312,596
2004	0	0	0	0	66,498	3,776	0	4,185	3,054,577	3,231,641
2005	4,684	0	0	0	68,190	2,709	0	4,251	3,599,377	3,753,001
2006	0	0	0	0	85,214	2,735	0	4,209	3,526,551	3,688,128
2007	0	49	0	0	93,954	6,071	0	3,776	3,023,174	3,215,731
2008	0	305	0	0	96,600	0	0	25,000	3,463,569	3,670,187
2009	0	305	0	0	98,100	0	0	25,000	3,472,001	3,686,082
2010	0	305	0	0	98,100	0	0	25,000	3,483,110	3,707,192
2011	0	305	0	0	98,100	0	0	25,000	3,481,616	3,707,508
2012	0	305	0	0	98,100	0	0	25,000	3,481,616	3,709,244
2013	0	305	0	0	87,600	6,000	0	25,000	3,503,036	3,772,921
2014	0	305	0	0	87,600	6,000	0	25,000	3,863,889	4,141,811
2015	0	305	0	0	87,600	6,000	0	25,000	3,863,889	4,142,636
2016	0	305	0	0	87,600	6,000	0	25,000	3,863,889	4,143,361
2017	0	305	0	0	87,600	6,000	0	25,000	3,863,889	4,143,986
2018	0	305	0	0	87,600	6,000	0	25,000	3,863,889	4,143,090
2019	0	305	0	0	87,600	6,000	0	25,000	3,863,889	4,145,236
2020	0	305	0	0	87,600	6,000	0	25,000	3,863,889	4,145,236
2021	0	305	0	0	87,600	6,000	0	25,000	3,863,889	4,145,936
2022	0	305	0	0	87,600	6,000	0	25,000	3,863,889	4,145,936
2023	0	305	0	0	87,600	6,000	0	25,000	3,863,889	4,145,936
2024	0	305	0	0	87,600	6,000	0	25,000	3,863,889	4,145,936
2025	0	305	0	0	87,600	6,000	0	25,000	3,863,889	4,145,936
2026	0	305	0	0	87,600	6,000	0	25,000	3,863,889	4,145,936
2027	0	305	0	0	87,600	6,000	0	25,000	3,863,889	4,145,936
2028	0	305	0	0	87,600	6,000	0	25,000	3,863,889	4,145,936
2029	0	305	0	0	87,600	6,000	0	25,000	3,863,889	4,145,936
2030	0	305	0	0	87,600	6,000	0	25,000	3,863,889	4,145,936
2031	0	305	0	0	87,600	6,000	0	25,000	3,863,889	4,145,936
2032	0	305	0	0	87,600	6,000	0	25,000	3,863,889	4,145,936
2033	0	305	0	0	87,600	6,000	0	25,000	3,863,889	4,145,936
2034	0	305	0	0	87,600	6,000	0	25,000	3,863,889	4,145,936
2035	0	305	0	0	87,600	6,000	0	25,000	3,863,889	4,145,936
TOTAL	4,684	8,589	200	5,861,402	489,750	5,662	741,888	1,505,240	176,870,804	189,769,187

**TABLE B-5B. Annual Water Quantities Delivered to Each Contractor**

(in acre-feet)

Sheet 1 of 4

Calendar Year	NORTH BAY AREA			SOUTH BAY AREA <sup>(b)</sup>				CENTRAL COASTAL AREA		
	Napa (a) County FC&WCD	Solano County WA	Total	Alameda County FC&WCD, Zone 7	Alameda County Water District	Santa Clara Valley Water District	Total	San Luis Obispo County FC&WCD	Santa Barbara County FC&WCD	Total
	[1]	[2]	[3]	[4]	[5]	[6]	[7]	[8]	[9]	[10]
1962	0	0	0	494	8,412	0	8,906	0	0	0
1963	0	0	0	1,731	10,914	0	12,645	0	0	0
1964	0	0	0	1,673	19,238	0	20,911	0	0	0
1965	0	0	0	2,605	16,407	15,014	34,026	0	0	0
1966	0	0	0	5,511	14,864	34,538	54,913	0	0	0
1967	0	0	0	4,780	12,882	39,101	56,763	0	0	0
1968	1,214	0	1,214	6,133	24,817	70,105	101,055	0	0	0
1969	2,687	0	2,687	6,635	813	62,264	69,712	0	0	0
1970	3,618	0	3,618	9,249	0	80,311	89,560	0	0	0
1971	2,521	0	2,521	5,017	5,961	87,606	98,584	0	0	0
1972	3,647	0	3,647	10,489	27,671	100,266	138,426	0	0	0
1973	3,792	0	3,792	2,975	2,521	88,582	94,078	0	0	0
1974	4,870	0	4,870	1,314	4	88,000	89,318	0	0	0
1975	6,840	0	6,840	4,618	986	88,000	93,604	0	0	0
1976	7,122	0	7,122	17,131	21,300	88,000	126,431	0	0	0
1977	8,226	0	8,226	12,644	18,840	76,220	107,704	0	0	0
1978	6,034	0	6,034	10,984	5,863	95,727	112,574	0	0	0
1979	6,561	0	6,561	19,325	10,874	91,991	122,190	0	0	0
1980	6,707	0	6,707	16,790	11,034	88,000	115,824	0	0	0
1981	9,001	0	9,001	19,590	21,917	88,000	129,507	0	0	0
1982	1,213	0	1,213	13,123	6,316	88,000	107,439	0	0	0
1983	2,287	0	2,287	4,766	3,157	86,733	94,656	0	0	0
1984	2,923	0	2,923	6,784	3,338	88,000	98,122	0	0	0
1985	4,039	0	4,039	15,072	19,016	88,000	122,088	0	0	0
1986	3,519	1,400	4,919	10,609	12,379	88,000	110,988	0	0	0
1987	7,693	1,550	9,243	23,406	25,390	88,000	136,796	0	0	0
1988	5,392	9,726	15,118	25,830	33,464	87,961	147,255	0	0	0
1989	6,195	17,256	23,451	26,227	26,042	90,000	142,269	0	0	0
1990	6,940	19,131	26,071	33,034	31,703	92,000	156,737	0	0	0
1991	1,380	6,972	8,352	9,411	12,648	28,200	50,259	0	1,240	1,240
1992	4,001	14,773	18,774	14,669	19,153	42,839	76,661	0	0	0
1993	5,286	29,180	34,466	33,635	10,271	62,065	105,971	0	0	0
1994	6,792	25,256	32,048	20,542	22,911	57,115	100,568	0	0	0
1995	5,182	21,345	26,527	30,091	17,793	28,756	76,640	0	0	0
1996	4,893	29,999	34,892	18,903	19,662	89,850	128,415	100	0	100
1997	4,341	33,530	37,871	27,522	24,063	95,601	147,186	1,199	7,439	8,638
1998	5,359	29,766	35,125	17,941	19,075	63,410	100,426	3,592	18,618	22,210
1999	5,304	34,753	40,057	50,910	37,652	82,945	171,507	3,743	20,137	23,880
2000	4,958	37,015	41,973	58,617	35,978	101,988	196,583	3,962	22,741	26,703
2001	9,345	34,586	43,931	34,409	18,004	77,922	130,335	4,283	18,946	23,229
2002	6,875	38,560	45,435	53,261	27,811	62,186	143,258	4,355	27,636	31,991
2003	7,646	33,951	41,597	45,450	36,590	108,981	191,021	4,453	26,968	31,421
2004	8,134	43,002	51,136	52,364	27,884	59,458	139,706	4,165	29,705	33,870
2005	7,669	37,819	45,488	47,512	44,599	128,249	220,360	4,251	23,344	27,595
2006	7,789	35,516	43,305	54,528	43,079	128,210	225,817	4,209	23,275	27,484
2007	11,457	46,928	58,385	40,157	24,391	75,382	139,930	3,776	27,740	31,516
2008	15,525	41,845	57,370	64,685	40,000	90,000	194,685	25,000	30,569	55,569
2009	19,525	40,845	60,370	66,272	40,000	90,000	196,272	25,000	45,486	70,486
2010	19,725	47,506	67,231	66,291	40,000	90,000	196,291	25,000	45,486	70,486
2011	20,025	47,556	67,581	67,671	40,000	90,000	197,671	25,000	45,486	70,486
2012	20,325	47,606	67,931	66,977	40,000	90,000	196,977	25,000	45,486	70,486
2013	25,150	47,656	72,806	72,722	42,000	100,000	214,722	25,000	45,486	70,486
2014	25,150	47,706	72,856	80,619	42,000	100,000	222,619	25,000	45,486	70,486
2015	25,825	47,756	73,581	80,619	42,000	100,000	222,619	25,000	45,486	70,486
2016	26,450	47,756	74,206	80,619	42,000	100,000	222,619	25,000	45,486	70,486
2017	27,075	47,756	74,831	80,619	42,000	100,000	222,619	25,000	45,486	70,486
2018	27,700	47,756	75,456	79,098	42,000	100,000	221,098	25,000	45,486	70,486
2019	28,325	47,756	76,081	80,619	42,000	100,000	222,619	25,000	45,486	70,486
2020	28,325	47,756	76,081	80,619	42,000	100,000	222,619	25,000	45,486	70,486
2021	29,025	47,756	76,781	80,619	42,000	100,000	222,619	25,000	45,486	70,486
2022	29,025	47,756	76,781	80,619	42,000	100,000	222,619	25,000	45,486	70,486
2023	29,025	47,756	76,781	80,619	42,000	100,000	222,619	25,000	45,486	70,486
2024	29,025	47,756	76,781	80,619	42,000	100,000	222,619	25,000	45,486	70,486
2025	29,025	47,756	76,781	80,619	42,000	100,000	222,619	25,000	45,486	70,486
2026	29,025	47,756	76,781	80,619	42,000	100,000	222,619	25,000	45,486	70,486
2027	29,025	47,756	76,781	80,619	42,000	100,000	222,619	25,000	45,486	70,486
2028	29,025	47,756	76,781	80,619	42,000	100,000	222,619	25,000	45,486	70,486
2029	29,025	47,756	76,781	80,619	42,000	100,000	222,619	25,000	45,486	70,486
2030	29,025	47,756	76,781	80,619	42,000	100,000	222,619	25,000	45,486	70,486
2031	29,025	47,756	76,781	80,619	42,000	100,000	222,619	25,000	45,486	70,486
2032	29,025	47,756	76,781	80,619	42,000	100,000	222,619	25,000	45,486	70,486
2033	29,025	47,756	76,781	80,619	42,000	100,000	222,619	25,000	45,486	70,486
2034	29,025	47,756	76,781	80,619	42,000	100,000	222,619	25,000	45,486	70,486
2035	29,025	47,756	76,781	80,619	42,000	100,000	222,619	25,000	45,486	70,486
TOTAL	963,952	1,905,610	2,869,562	3,105,176	2,003,687	6,121,576	11,230,439	742,088	1,506,480	2,248,568

a) For the period 1968 through 1987, deliveries are non-Project water pumped through an interim facility.  
 b) For the period June 1962 through November 1967, deliveries were supplied by non-Project water.

**TABLE B-5B. Annual Water Quantities Delivered to Each Contractor**

(in acre-feet)

Sheet 2 of 4

Calendar Year	SAN JOAQUIN VALLEY AREA								
	Dudley Ridge Water District	Empire West Side Irrigation District	Kern County Water Agency			County of Kings	Oak Flat Water District	Tulare Lake Basin Water Storage District	Total
			Municipal and Industrial	Agricultural	Total				
	[11]	[12]	[13]	[14]	[15]	[16]	[17]	[18]	[19]
1962	0	0	0	0	0	0	0	0	0
1963	0	0	0	0	0	0	0	0	0
1964	0	0	0	0	0	0	0	0	0
1965	0	0	0	0	0	0	0	0	0
1966	0	0	0	0	0	0	0	0	0
1967	0	0	0	0	0	0	0	0	0
1968	26,360	1,978	0	127,384	127,384	900	3,084	25,100	184,806
1969	31,375	56	0	141,265	141,265	100	3,016	9,923	185,735
1970	40,407	3,942	0	204,634	204,634	0	5,911	9,578	264,472
1971	41,053	5,990	0	360,151	360,151	3,700	7,212	122,485	540,591
1972	42,443	5,795	0	490,781	490,781	1,400	8,166	258,393	806,978
1973	22,057	3,000	0	341,469	341,469	1,500	3,214	50,464	421,704
1974	33,390	3,000	23,708	323,292	347,000	1,500	3,471	72,289	460,650
1975	40,555	3,000	14,529	396,291	410,820	1,600	3,576	86,258	545,809
1976	41,421	3,000	46,719	392,531	439,250	1,600	4,112	58,811	548,194
1977	11,153	738	27,882	163,425	191,307	1,530	1,472	18,081	224,281
1978	51,747	454	76,895	590,452	667,347	2,070	3,906	12,053	737,577
1979	38,544	1,739	62,997	683,049	746,046	2,000	6,149	155,121	949,599
1980	41,000	894	45,943	588,557	634,500	2,200	5,700	75,444	759,738
1981	41,000	5,859	75,758	615,642	691,400	2,300	4,300	83,438	828,297
1982	41,000	361	47,477	697,823	745,300	1,750	3,838	18,551	810,800
1983	42,900	0	6,854	587,653	594,507	3,550	3,822	1,006	645,785
1984	45,100	0	90,904	769,696	860,600	3,100	5,700	5,743	920,243
1985	46,251	5,197	88,515	800,381	888,896	3,400	5,433	109,791	1,058,968
1986	50,249	1,170	77,240	829,101	906,341	3,700	5,107	79,355	1,045,922
1987	46,288	2,525	117,174	852,731	969,905	4,000	5,625	93,084	1,121,427
1988	47,994	3,475	122,409	887,111	1,009,520	4,000	4,412	95,866	1,165,267
1989	57,049	3,000	123,896	1,022,166	1,146,062	4,000	6,091	127,950	1,344,152
1990	36,296	1,279	127,837	584,611	712,448	2,000	2,922	57,070	812,015
1991	927	221	33,122	8,965	42,087	0	141	2,180	45,556
1992	23,770	1,354	62,326	420,894	483,220	1,806	2,239	46,728	559,117
1993	50,618	2,741	128,316	1,039,614	1,167,930	4,000	4,858	124,468	1,354,615
1994	28,793	1,666	87,139	570,020	657,159	2,116	3,071	62,362	755,167
1995	60,686	1,631	135,415	1,016,114	1,151,529	4,000	5,169	101,869	1,324,884
1996	56,948	1,868	135,654	1,049,409	1,185,063	4,000	4,904	236,875	1,489,658
1997	71,308	0	120,708	987,451	1,108,159	0	5,238	22,369	1,207,074
1998	55,650	542	89,765	768,825	858,590	15	4,401	20,677	939,875
1999	59,697	3,176	138,153	1,039,985	1,178,138	4,000	4,871	289,735	1,539,617
2000	60,539	1,799	122,484	1,055,885	1,178,369	3,600	4,508	198,313	1,447,128
2001	41,548	1,360	21,460	632,831	654,291	1,560	3,592	84,726	787,077
2002	48,915	1,405	90,967	737,864	828,831	2,854	4,885	96,502	983,392
2003	46,082	1,436	107,978	856,252	964,230	3,692	4,266	105,841	1,125,547
2004	49,080	3,562	127,711	716,220	843,931	9,053	4,629	90,021	1,000,276
2005	79,005	3,834	92,581	1,305,400	1,397,981	19,806	4,194	140,002	1,644,822
2006	72,080	3,282	99,302	1,163,567	1,262,869	9,530	4,242	108,207	1,460,210
2007	45,135	2,084	80,175	900,862	981,037	5,746	3,567	87,083	1,124,652
2008	53,343	3,000	117,420	840,008	957,428	9,305	5,300	95,922	1,124,298
2009	57,343	3,000	117,590	833,564	951,154	9,305	5,700	95,922	1,122,424
2010	57,343	3,000	117,590	837,354	954,944	9,305	5,700	88,922	1,119,214
2011	57,343	3,000	117,590	833,564	951,154	9,305	5,700	88,922	1,115,424
2012	57,343	3,000	117,590	833,564	951,154	9,305	5,700	88,922	1,115,424
2013	57,343	3,000	134,600	850,447	985,047	9,305	5,700	88,922	1,149,317
2014	57,343	3,000	134,600	864,130	998,730	9,305	5,700	88,922	1,163,000
2015	57,343	3,000	134,600	864,130	998,730	9,305	5,700	88,922	1,163,000
2016	57,343	3,000	134,600	864,130	998,730	9,305	5,700	88,922	1,163,000
2017	57,343	3,000	134,600	864,130	998,730	9,305	5,700	88,922	1,163,000
2018	57,343	3,000	134,600	864,130	998,730	9,305	5,700	88,922	1,163,000
2019	57,343	3,000	134,600	864,130	998,730	9,305	5,700	88,922	1,163,000
2020	57,343	3,000	134,600	864,130	998,730	9,305	5,700	88,922	1,163,000
2021	57,343	3,000	134,600	864,130	998,730	9,305	5,700	88,922	1,163,000
2022	57,343	3,000	134,600	864,130	998,730	9,305	5,700	88,922	1,163,000
2023	57,343	3,000	134,600	864,130	998,730	9,305	5,700	88,922	1,163,000
2024	57,343	3,000	134,600	864,130	998,730	9,305	5,700	88,922	1,163,000
2025	57,343	3,000	134,600	864,130	998,730	9,305	5,700	88,922	1,163,000
2026	57,343	3,000	134,600	864,130	998,730	9,305	5,700	88,922	1,163,000
2027	57,343	3,000	134,600	864,130	998,730	9,305	5,700	88,922	1,163,000
2028	57,343	3,000	134,600	864,130	998,730	9,305	5,700	88,922	1,163,000
2029	57,343	3,000	134,600	864,130	998,730	9,305	5,700	88,922	1,163,000
2030	57,343	3,000	134,600	864,130	998,730	9,305	5,700	88,922	1,163,000
2031	57,343	3,000	134,600	864,130	998,730	9,305	5,700	88,922	1,163,000
2032	57,343	3,000	134,600	864,130	998,730	9,305	5,700	88,922	1,163,000
2033	57,343	3,000	134,600	864,130	998,730	9,305	5,700	88,922	1,163,000
2034	57,343	3,000	134,600	864,130	998,730	9,305	5,700	88,922	1,163,000
2035	57,343	3,000	134,600	864,130	998,730	9,305	5,700	88,922	1,163,000
<b>TOTAL</b>	<b>3,368,017</b>	<b>172,413</b>	<b>6,533,573</b>	<b>50,759,715</b>	<b>57,293,288</b>	<b>388,218</b>	<b>334,214</b>	<b>5,947,628</b>	<b>67,503,778</b>

**TABLE B-5B. Annual Water Quantities Delivered to Each Contractor**

(in acre-feet)

Sheet 3 of 4

Calendar Year	SOUTHERN CALIFORNIA AREA									
	Antelope Valley-East Kern Water Agency	Castaic Lake Water Agency(c)	Coachella Valley Water District	Crestline-Lake Arrowhead Water Agency	Desert Water Agency	Little Rock Creek Irrigation District	Mojave Water Agency	Palmdale Water District	San Bernardino Valley Municipal Water District	San Gabriel Valley Municipal Water District
	[20]	[21]	[22]	[23]	[24]	[25]	[26]	[27]	[28]	[29]
1962	0	0	0	0	0	0	0	0	0	0
1963	0	0	0	0	0	0	0	0	0	0
1964	0	0	0	0	0	0	0	0	0	0
1965	0	0	0	0	0	0	0	0	0	0
1966	0	0	0	0	0	0	0	0	0	0
1967	0	0	0	0	0	0	0	0	0	0
1968	0	7,382	0	0	0	0	0	0	0	0
1969	0	9,970	0	0	0	0	0	0	0	0
1970	0	11,739	0	0	0	0	0	0	0	0
1971	0	12,490	0	0	0	0	0	0	0	0
1972	53	13,905	0	464	0	338	55	0	1,275	0
1973	20	9,418	5,800	389	9,000	290	0	0	32,426	0
1974	1,259	9,700	6,400	627	10,000	400	14	0	16,605	612
1975	8,068	10,700	7,000	825	11,000	520	0	0	13,865	5,450
1976	27,782	11,700	7,600	1,002	12,000	589	0	0	12,273	6,071
1977	11,202	5,075	0	1,109	0	111	80	0	24,833	8,996
1978	44,137	11,362	10,084	1,209	15,300	208	0	0	4,055	7,771
1979	60,493	19,145	10,063	1,260	15,000	133	4,000	0	18	290
1980	72,407	15,092	10,884	1,239	17,000	191	4,000	0	0	1,085
1981	79,375	18,461	12,105	1,485	19,000	1,270	4,000	0	16,021	3,619
1982	50,291	22,216	13,326	1,238	21,000	0	10,500	0	8,409	12,599
1983	32,961	22,135	14,547	911	23,000	38	0	0	5,994	734
1984	32,662	24,218	15,768	1,128	25,000	1	0	0	5,556	7,656
1985	37,064	24,500	16,989	1,422	27,000	0	0	1,558	7,390	5,028
1986	32,449	27,229	18,210	1,506	29,000	163	0	3,096	6,421	9,454
1987	34,089	27,988	19,431	1,849	31,500	1,085	17	5,379	18,751	10,630
1988	34,079	30,438	20,652	2,006	34,000	419	9	1,770	21,386	8,948
1989	45,280	36,364	21,873	2,170	36,500	971	200	9,009	20,782	12,839
1990	47,206	28,579	23,100	1,827	38,100	1,747	0	8,608	18,831	16,649
1991	9,568	4,562	6,930	849	11,430	522	3,423	3,914	3,661	5,399
1992	30,265	20,699	10,427	519	17,197	251	10,686	4,035	3,358	7,908
1993	43,102	23,039	23,100	439	38,100	734	11,514	7,761	4,361	14,397
1994	49,153	26,441	14,102	785	23,257	1,098	16,852	8,418	9,135	15,230
1995	47,286	27,233	23,100	409	38,100	480	8,722	6,961	696	12,922
1996	56,356	32,500	62,219	485	102,622	494	7,427	11,434	6,064	15,989
1997	62,393	27,712	68,340	651	69,990	444	10,374	11,861	9,654	18,175
1998	52,926	20,093	85,709	187	70,647	404	3,925	8,752	1,878	9,310
1999	69,073	32,899	50,480	1,132	58,100	342	8,144	13,278	12,874	21,729
2000	83,577	40,680	42,323	1,194	58,234	0	11,380	9,060	18,399	15,140
2001	62,857	31,939	9,100	1,057	15,010	0	4,433	10,427	26,488	2,360
2002	58,171	68,817	16,755	2,189	27,640	0	4,346	18,496	72,069	24,851
2003	60,029	55,736	14,443	1,563	23,819	0	14,435	11,547	27,415	21,934
2004	59,731	83,761	15,465	2,006	21,190	0	13,176	12,162	56,150	12,541
2005	59,831	59,456	42,519	205	49,089	0	13,561	11,712	33,977	13,984
2006	80,384	62,752	121,100	641	50,000	0	34,014	12,492	35,331	16,284
2007	78,823	60,190	73,228	1,768	30,234	1,380	20,109	19,634	54,185	10,000
2008	70,700	47,600	84,770	3,160	35,000	2,300	41,885	19,300	102,600	28,800
2009	70,700	47,600	121,100	3,340	50,000	2,300	37,900	21,300	102,600	28,800
2010	70,700	47,600	138,350	3,460	50,000	2,300	37,900	21,300	102,600	28,800
2011	72,856	47,600	138,350	3,600	50,000	2,300	37,900	21,300	102,600	28,800
2012	74,736	47,600	138,350	3,720	50,000	2,300	37,900	21,300	102,600	28,800
2013	70,700	56,000	138,350	3,720	50,000	2,300	40,610	21,300	102,600	28,800
2014	141,400	95,200	138,350	5,800	50,000	2,300	75,800	21,300	102,600	28,800
2015	141,400	95,200	138,350	5,800	50,000	2,300	75,800	21,300	102,600	28,800
2016	141,400	95,200	138,350	5,800	50,000	2,300	75,800	21,300	102,600	28,800
2017	141,400	95,200	138,350	5,800	50,000	2,300	75,800	21,300	102,600	28,800
2018	141,400	95,200	138,350	5,800	50,000	2,300	75,800	21,300	102,600	28,800
2019	141,400	95,200	138,350	5,800	50,000	2,300	75,800	21,300	102,600	28,800
2020	141,400	95,200	138,350	5,800	50,000	2,300	75,800	21,300	102,600	28,800
2021	141,400	95,200	138,350	5,800	50,000	2,300	75,800	21,300	102,600	28,800
2022	141,400	95,200	138,350	5,800	50,000	2,300	75,800	21,300	102,600	28,800
2023	141,400	95,200	138,350	5,800	50,000	2,300	75,800	21,300	102,600	28,800
2024	141,400	95,200	138,350	5,800	50,000	2,300	75,800	21,300	102,600	28,800
2025	141,400	95,200	138,350	5,800	50,000	2,300	75,800	21,300	102,600	28,800
2026	141,400	95,200	138,350	5,800	50,000	2,300	75,800	21,300	102,600	28,800
2027	141,400	95,200	138,350	5,800	50,000	2,300	75,800	21,300	102,600	28,800
2028	141,400	95,200	138,350	5,800	50,000	2,300	75,800	21,300	102,600	28,800
2029	141,400	95,200	138,350	5,800	50,000	2,300	75,800	21,300	102,600	28,800
2030	141,400	95,200	138,350	5,800	50,000	2,300	75,800	21,300	102,600	28,800
2031	141,400	95,200	138,350	5,800	50,000	2,300	75,800	21,300	102,600	28,800
2032	141,400	95,200	138,350	5,800	50,000	2,300	75,800	21,300	102,600	28,800
2033	141,400	95,200	138,350	5,800	50,000	2,300	75,800	21,300	102,600	28,800
2034	141,400	95,200	138,350	5,800	50,000	2,300	75,800	21,300	102,600	28,800
2035	141,400	95,200	138,350	5,800	50,000	2,300	75,800	21,300	102,600	28,800
<b>TOTAL</b>	<b>5,155,594</b>	<b>3,476,715</b>	<b>4,716,142</b>	<b>188,345</b>	<b>2,463,059</b>	<b>79,023</b>	<b>2,121,091</b>	<b>805,764</b>	<b>3,483,386</b>	<b>1,162,984</b>

c) Devil's Den Water District merged with Castaic Lake Water Agency effective January 1, 1992.

**TABLE B-5B. Annual Water Quantities Delivered to Each Contractor**

(in acre-feet)

Sheet 4 of 4

Calendar Year	SOUTHERN CALIFORNIA AREA (contd.)				FEATHER RIVER AREA				South Bay Area Future Contractor	GRAND TOTAL
	San Gorgonio Pass Water Agency	The Metropolitan Water District of Southern California	Ventura County Watershed Protection District	Total	City of Yuba City	County of Butte	Plumas County FC&WCD	Total		
	[30]	[31]	[32]	[33]	[34]	[35]	[36]	[37]	[38]	[39]
1962	0	0	0	0	0	0	0	0	0	8,906
1963	0	0	0	0	0	0	0	0	0	12,645
1964	0	0	0	0	0	0	0	0	0	20,911
1965	0	0	0	0	0	0	0	0	0	34,026
1966	0	0	0	0	0	0	0	0	0	54,913
1967	0	0	0	0	0	0	0	0	0	56,763
1968	0	0	0	7,382	0	0	0	0	0	294,457
1969	0	0	0	9,970	0	0	0	0	0	268,104
1970	0	0	0	11,739	0	0	70	70	0	369,459
1971	0	0	0	12,490	0	192	64	256	0	654,442
1972	0	71,938	0	88,028	0	186	505	691	0	1,037,770
1973	0	159,883	0	217,226	0	53	679	732	0	737,532
1974	0	277,717	0	323,334	0	127	648	775	0	878,947
1975	0	526,491	0	583,919	0	253	405	658	0	1,230,830
1976	0	618,451	0	697,468	0	527	382	909	0	1,380,124
1977	0	189,755	0	241,161	0	706	303	1,009	0	582,381
1978	0	507,565	0	601,691	0	579	278	857	0	1,458,733
1979	0	477,074	0	587,476	0	302	329	631	0	1,666,457
1980	0	531,727	0	653,625	0	267	295	562	0	1,536,456
1981	0	795,846	0	951,182	0	221	355	576	0	1,918,563
1982	0	691,192	0	830,771	0	334	305	639	0	1,750,862
1983	0	343,521	0	443,841	0	325	262	587	0	1,187,156
1984	0	457,582	0	569,571	108	177	272	557	0	1,591,416
1985	0	683,625	0	804,576	62	308	254	624	0	1,990,295
1986	0	708,840	0	836,368	328	313	317	958	0	1,999,155
1987	0	712,424	0	863,143	88	459	452	999	0	2,131,608
1988	0	902,564	0	1,056,271	303	385	523	1,211	0	2,385,122
1989	0	1,156,698	0	1,342,686	403	300	486	1,189	0	2,853,747
1990	0	1,396,423	4,836	1,585,906	494	380	548	1,422	0	2,582,151
1991	0	391,447	988	442,693	265	328	420	1,013	0	549,113
1992	0	710,313	0	815,658	642	117	485	1,244	0	1,471,454
1993	0	652,190	0	818,737	746	256	444	1,446	0	2,315,235
1994	0	807,866	0	972,337	1,035	329	492	1,856	0	1,861,976
1995	0	436,042	0	601,951	910	203	308	1,421	0	2,031,423
1996	0	593,380	0	888,970	820	257	360	1,437	0	2,543,472
1997	0	721,810	1,850	1,003,254	1,005	185	231	1,421	0	2,405,444
1998	0	410,065	1,850	665,746	1,054	527	0	1,581	0	1,764,963
1999	0	852,617	1,850	1,122,518	1,096	286	0	1,382	0	2,898,961
2000	0	1,541,816	4,050	1,825,853	901	586	0	1,487	0	3,539,727
2001	0	1,023,169	1,850	1,188,690	1,065	513	0	1,578	0	2,174,840
2002	0	1,408,919	4,998	1,707,251	1,181	419	0	1,600	0	2,912,927
2003	116	1,686,973	5,000	1,923,010	1,324	551	0	1,875	0	3,314,471
2004	841	1,724,380	5,250	2,006,653	1,434	1,440	0	2,874	0	3,234,515
2005	692	1,528,045	1,665	1,814,736	1,894	527	0	2,421	0	3,755,422
2006	4,278	1,512,186	1,850	1,931,312	5,342	468	0	5,810	0	3,693,938
2007	4,009	1,504,688	3,000	1,861,248	2,327	956	0	3,283	0	3,219,014
2008	17,300	1,762,830	20,000	2,236,245	4,800	27,500	2,020	34,320	0	3,702,487
2009	17,300	1,711,500	20,000	2,234,440	4,800	27,500	2,090	34,390	0	3,718,382
2010	17,300	1,711,500	20,000	2,251,810	4,800	27,500	2,160	34,460	0	3,739,492
2011	17,300	1,711,500	20,000	2,254,106	4,800	27,500	2,240	34,540	0	3,739,808
2012	17,300	1,711,500	20,000	2,256,106	4,800	27,500	2,320	34,620	0	3,741,544
2013	17,300	1,711,500	20,000	2,263,180	9,600	27,500	2,410	39,510	0	3,810,021
2014	17,300	1,911,500	20,000	2,610,350	9,600	27,500	2,500	39,600	0	4,178,911
2015	17,300	1,911,500	20,000	2,610,350	9,600	27,500	2,600	39,700	0	4,179,736
2016	17,300	1,911,500	20,000	2,610,350	9,600	27,500	2,700	39,800	0	4,180,461
2017	17,300	1,911,500	20,000	2,610,350	9,600	27,500	2,700	39,800	0	4,181,086
2018	17,300	1,911,500	20,000	2,610,350	9,600	27,500	2,700	39,800	0	4,180,190
2019	17,300	1,911,500	20,000	2,610,350	9,600	27,500	2,700	39,800	0	4,182,336
2020	17,300	1,911,500	20,000	2,610,350	9,600	27,500	2,700	39,800	0	4,182,336
2021	17,300	1,911,500	20,000	2,610,350	9,600	27,500	2,700	39,800	0	4,183,036
2022	17,300	1,911,500	20,000	2,610,350	9,600	27,500	2,700	39,800	0	4,183,036
2023	17,300	1,911,500	20,000	2,610,350	9,600	27,500	2,700	39,800	0	4,183,036
2024	17,300	1,911,500	20,000	2,610,350	9,600	27,500	2,700	39,800	0	4,183,036
2025	17,300	1,911,500	20,000	2,610,350	9,600	27,500	2,700	39,800	0	4,183,036
2026	17,300	1,911,500	20,000	2,610,350	9,600	27,500	2,700	39,800	0	4,183,036
2027	17,300	1,911,500	20,000	2,610,350	9,600	27,500	2,700	39,800	0	4,183,036
2028	17,300	1,911,500	20,000	2,610,350	9,600	27,500	2,700	39,800	0	4,183,036
2029	17,300	1,911,500	20,000	2,610,350	9,600	27,500	2,700	39,800	0	4,183,036
2030	17,300	1,911,500	20,000	2,610,350	9,600	27,500	2,700	39,800	0	4,183,036
2031	17,300	1,911,500	20,000	2,610,350	9,600	27,500	2,700	39,800	0	4,183,036
2032	17,300	1,911,500	20,000	2,610,350	9,600	27,500	2,700	39,800	0	4,183,036
2033	17,300	1,911,500	20,000	2,610,350	9,600	27,500	2,700	39,800	0	4,183,036
2034	17,300	1,911,500	20,000	2,610,350	9,600	27,500	2,700	39,800	0	4,183,036
2035	17,300	1,911,500	20,000	2,610,350	9,600	27,500	2,700	39,800	0	4,183,036
<b>TOTAL</b>	<b>494,336</b>	<b>81,088,552</b>	<b>599,037</b>	<b>105,834,028</b>	<b>269,627</b>	<b>784,342</b>	<b>82,812</b>	<b>1,136,781</b>	<b>0</b>	<b>190,823,156</b>

**TABLE B-6. Annual Water Quantities Conveyed through Each Pumping and Power Recovery Plant of Project Transportation Facilities**

(in acre-feet)

Sheet 1 of 10

Calendar Year	NORTH BAY AQUEDUCT											
	Barker Slough Pumping Plant				Cordelia Pumping Plant Solano County WA				Cordelia Pumping Plant Napa County FC&WCD			
	Initial Fill Water	Operational Losses	Water Supply Delivery	Total	Initial Fill Water	Operational Losses	Water Supply Delivery	Total	Initial Fill Water	Operational Losses	Water Supply Delivery (a)	Total
[1]	[2]	[3]	[4]	[5]	[6]	[7]	[8]	[9]	[10]	[11]	[12]	
1961	0	0	0	0	0	0	0	0	0	0	0	0
1962	0	0	0	0	0	0	0	0	0	0	0	0
1963	0	0	0	0	0	0	0	0	0	0	0	0
1964	0	0	0	0	0	0	0	0	0	0	0	0
1965	0	0	0	0	0	0	0	0	0	0	0	0
1966	0	0	0	0	0	0	0	0	0	0	0	0
1967	0	0	0	0	0	0	0	0	0	0	0	0
1968	0	0	0	0	0	0	0	0	24	(10)	1,214	1,228
1969	0	0	0	0	0	0	0	0	0	2	2,687	2,689
1970	0	0	0	0	0	0	0	0	0	18	3,618	3,636
1971	0	0	0	0	0	0	0	0	0	4	2,521	2,525
1972	0	0	0	0	0	0	0	0	0	(10)	3,647	3,637
1973	0	0	0	0	0	0	0	0	0	1	3,792	3,793
1974	0	0	0	0	0	0	0	0	0	10	4,870	4,880
1975	0	0	0	0	0	0	0	0	0	10	6,840	6,850
1976	0	0	0	0	0	0	0	0	0	4	7,122	7,126
1977	0	0	0	0	0	0	0	0	0	2	8,226	8,228
1978	0	0	0	0	0	0	0	0	0	(6)	6,034	6,028
1979	0	0	0	0	0	0	0	0	0	1	6,561	6,562
1980	0	0	0	0	0	0	0	0	0	(3)	6,707	6,704
1981	0	0	0	0	0	0	0	0	0	8	9,001	9,009
1982	0	0	0	0	0	0	0	0	0	(8)	1,213	1,205
1983	0	0	0	0	0	0	0	0	0	(12)	2,287	2,275
1984	0	0	0	0	0	0	0	0	0	(15)	2,923	2,908
1985	0	0	0	0	0	0	0	0	0	13	4,039	4,052
1986	0	0	0	0	0	0	0	0	0	(4)	3,519	3,515
1987	0	0	0	0	0	0	0	0	0	0	7,693	7,693
1988	1	283	15,118	15,402	0	0	9,725	9,725	1	(1)	5,392	5,392
1989	0	758	23,451	24,209	0	0	17,246	17,246	0	(4)	6,195	6,191
1990	0	3	26,071	26,074	0	(634)	15,856	15,222	0	3	6,940	6,943
1991	0	667	8,352	9,019	0	124	3,855	3,979	0	198	1,380	1,578
1992	0	1,643	18,774	20,417	0	0	9,220	9,220	0	0	4,001	4,001
1993	0	1,153	34,466	35,619	0	0	14,471	14,471	0	0	5,286	5,286
1994	0	780	32,048	32,828	0	(6)	14,913	14,907	0	0	6,792	6,792
1995	0	908	26,527	27,435	0	0	15,893	15,893	0	0	5,182	5,182
1996	0	1,354	34,892	36,246	0	0	17,069	17,069	0	0	4,893	4,893
1997	0	1,422	37,871	39,293	0	0	17,501	17,501	0	0	4,341	4,341
1998	0	1,343	35,125	36,468	0	0	18,204	18,204	0	0	5,359	5,359
1999	0	2,522	40,057	42,579	0	0	19,562	19,562	0	0	5,304	5,304
2000	0	1,853	41,973	43,826	0	4	21,525	21,529	0	180	4,958	5,138
2001	0	1,760	43,931	45,691	0	0	19,737	19,737	0	0	9,345	9,345
2002	0	496	45,435	45,931	0	0	19,719	19,719	0	0	6,875	6,875
2003	0	3,991	41,597	45,588	0	0	16,700	16,700	0	0	7,637	7,637
2004	0	2,181	51,136	53,317	0	0	22,186	22,186	0	0	7,999	7,999
2005	0	935	45,488	46,423	0	0	19,689	19,689	0	0	7,509	7,509
2006	0	1,005	43,305	44,310	0	0	19,151	19,151	0	0	7,581	7,581
2007	0	1,189	58,385	59,574	0	0	27,921	27,921	0	0	11,277	11,277
2008	0	51	57,370	57,421	0	0	28,254	28,254	0	5	15,400	15,405
2009	0	51	60,370	60,421	0	0	27,254	27,254	0	5	19,400	19,405
2010	0	51	67,231	67,282	0	0	33,915	33,915	0	5	19,600	19,605
2011	0	51	67,581	67,632	0	0	33,965	33,965	0	5	19,900	19,905
2012	0	51	67,931	67,982	0	0	34,015	34,015	0	5	20,200	20,205
2013	0	51	72,806	72,857	0	0	33,940	33,940	0	5	25,150	25,155
2014	0	51	72,856	72,907	0	0	33,990	33,990	0	5	25,150	25,155
2015	0	51	73,581	73,632	0	0	34,040	34,040	0	5	25,825	25,830
2016	0	51	74,206	74,257	0	0	34,040	34,040	0	5	26,450	26,455
2017	0	51	74,831	74,882	0	0	34,040	34,040	0	5	27,075	27,080
2018	0	51	75,456	75,507	0	0	34,040	34,040	0	5	27,700	27,705
2019	0	51	76,081	76,132	0	0	34,040	34,040	0	5	28,325	28,330
2020	0	51	76,081	76,132	0	0	34,040	34,040	0	5	28,325	28,330
2021	0	51	76,781	76,832	0	0	34,040	34,040	0	5	29,025	29,030
2022	0	51	76,781	76,832	0	0	34,040	34,040	0	5	29,025	29,030
2023	0	51	76,781	76,832	0	0	34,040	34,040	0	5	29,025	29,030
2024	0	51	76,781	76,832	0	0	34,040	34,040	0	5	29,025	29,030
2025	0	51	76,781	76,832	0	0	34,040	34,040	0	5	29,025	29,030
2026	0	51	76,781	76,832	0	0	34,040	34,040	0	5	29,025	29,030
2027	0	51	76,781	76,832	0	0	34,040	34,040	0	5	29,025	29,030
2028	0	51	76,781	76,832	0	0	34,040	34,040	0	5	29,025	29,030
2029	0	51	76,781	76,832	0	0	34,040	34,040	0	5	29,025	29,030
2030	0	51	76,781	76,832	0	0	34,040	34,040	0	5	29,025	29,030
2031	0	51	76,781	76,832	0	0	34,040	34,040	0	5	29,025	29,030
2032	0	51	76,781	76,832	0	0	34,040	34,040	0	5	29,025	29,030
2033	0	51	76,781	76,832	0	0	34,040	34,040	0	5	29,025	29,030
2034	0	51	76,781	76,832	0	0	34,040	34,040	0	5	29,025	29,030
2035	0	51	76,781	76,832	0	0	34,040	34,040	0	5	29,025	29,030

a) For the period 1968 through 1987, deliveries are non-SWP water pumped through an interim facility.



**TABLE B-6. Annual Water Quantities Conveyed through Each Pumping and Power Recovery Plant of Project Transportation Facilities**

(in acre-feet)

Sheet 2 of 10

Calendar  Year	SOUTH BAY AQUEDUCT						CALIFORNIA AQUEDUCT									
	South Bay Pumping Plant						North San Joaquin Division Banks Pumping Plant Transportation Water									
	Initial Fill Water	Operational Losses	Reservoir Storage Changes	Deliveries		Total	Initial Fill Water	Operational Losses	Reservoir Storage Changes	Deliveries		Total	Conservation Water	Total		
				Water Supply (b)	Recreation					Water Supply	Recreation					
[13]	[14]	[15]	[16]	[17]	[18]	[19]	[20]	[21]	[22]	[23]	[24]	[25]	[26]			
1961	0	0	0	0	0	0	0	0	0	0	0	0	0	0		
1962	9	272	0	8,906	0	9,187	0	0	0	0	0	0	0	0		
1963	71	185	0	12,645	0	12,901	0	0	0	0	0	0	0	0		
1964	171	152	0	20,911	0	21,234	0	0	0	0	0	0	0	0		
1965	93	729	0	34,026	0	34,848	0	0	0	0	0	0	0	0		
1966	0	1,746	0	54,913	0	56,659	0	0	0	0	0	0	0	0		
1967	0	1,677	0	56,763	0	58,440	5,746	1,183	0	11,538	0	18,467	2,957	21,424		
1968	0	1,847	0	101,055	0	102,902	11,079	74,464	0	293,243	0	378,786	531,275	910,061		
1969	3,449	2,668	0	69,712	0	75,829	7,336	44,287	0	265,417	0	317,040	531,185	848,225		
1970	16,279	1,086	(5,355)	89,560	0	101,570	23,947	20,767	(5,355)	365,771	0	405,130	(12,995)	392,135		
1971	0	1,815	8,854	98,584	0	109,253	23,207	(10,754)	8,854	651,665	8	672,980	7,708	680,688		
1972	0	3,557	2,273	138,426	0	144,256	145,066	9,057	(4,285)	1,033,432	6,489	1,189,759	48,300	1,238,059		
1973	0	(33)	(1,510)	94,078	0	92,535	214,941	(4,951)	2,902	733,008	1,155	947,055	55,846	1,002,901		
1974	0	1,287	(10,056)	89,318	0	80,549	247,894	(11,526)	(32,510)	873,302	2,118	1,079,278	54,683	1,133,961		
1975	0	320	8,550	93,604	0	102,474	110,149	(8,092)	16,101	1,223,332	3,377	1,344,867	(102,625)	1,242,242		
1976	0	2,431	1,391	126,431	141	130,394	67,834	5,443	(244,124)	1,372,093	1,745	1,202,991	(442,348)	760,643		
1977	0	2,866	2,685	107,704	112	113,367	0	39,897	(157,543)	573,146	1,111	456,611	(13,507)	443,104		
1978	0	2,165	(11,249)	112,574	126	103,616	67,457	(36,898)	35,129	1,451,842	1,177	1,518,707	752,078	2,270,786		
1979	0	2,401	1,069	122,190	89	125,749	17,397	60,958	(32,307)	1,659,265	1,398	1,706,711	(112,053)	1,594,658		
1980	0	1,758	(6,563)	115,824	123	111,142	3,159	58,484	(275,538)	1,529,187	2,131	1,317,423	186,601	1,504,024		
1981	0	2,627	13,742	129,507	121	145,997	46,060	85,350	40,536	1,908,986	4,974	2,085,906	(931,878)	1,154,028		
1982	0	2,344	(23,928)	107,439	129	85,984	5,979	61,556	99,897	1,743,145	4,646	1,915,223	347,983	2,263,206		
1983	0	2,151	(22,886)	94,656	132	74,053	6,071	47,022	(310,477)	1,184,282	7,853	934,751	835,771	1,770,522		
1984	0	2,088	8,442	98,122	158	108,810	38,649	97,143	(108,548)	1,587,936	5,874	1,621,054	21,875	1,642,929		
1985	0	2,817	(1,607)	122,088	152	123,450	0	110,469	137,783	1,985,632	5,452	2,239,336	(110,569)	2,128,767		
1986	0	2,299	(1,850)	110,988	130	111,567	0	90,799	20,177	1,993,278	3,865	2,108,119	200,298	2,308,417		
1987	0	2,625	(584)	136,796	137	138,974	0	91,427	(23,116)	2,121,366	7,672	2,197,349	(458,725)	1,738,624		
1988	0	2,884	(698)	147,255	142	149,583	0	107,249	(35,484)	2,368,793	4,889	2,445,447	(303,583)	2,141,864		
1989	0	2,673	3,296	142,269	152	148,390	0	117,603	(38,058)	2,829,107	8,135	2,916,787	421,131	3,337,918		
1990	0	894	1,982	156,537	168	159,581	0	99,059	(290,965)	2,554,658	9,262	2,372,014	(374,027)	1,997,987		
1991	0	2,637	(4,532)	50,259	150	48,514	0	80,106	(79,038)	539,748	4,879	545,695	554,904	1,100,599		
1992	0	2,881	756	76,661	147	80,445	0	91,391	(218,170)	1,451,436	2,605	1,327,262	61,343	1,388,605		
1993	0	1,940	(20,051)	105,971	143	88,003	0	149,372	(273,789)	2,279,323	2,609	2,157,515	849,249	3,006,764		
1994	0	1,981	1,714	100,568	168	104,431	0	148,712	(120,985)	1,828,072	3,803	1,859,602	(324,640)	1,534,962		
1995	0	1,188	(12,333)	76,640	146	65,641	0	173,074	(397,605)	2,003,475	2,575	1,781,519	293,159	2,074,678		
1996	0	981	(1,990)	77,215	150	76,356	0	123,502	78,123	2,507,143	3,902	2,712,670	288,576	3,001,246		
1997	0	1,575	5,016	102,186	155	108,932	527	135,106	(98,334)	2,366,152	2,594	2,406,045	(50,000)	2,356,045		
1998	0	1,551	3,595	70,876	114	76,136	0	91,319	(346,039)	1,728,257	2,107	1,475,644	120,886	1,596,530		
1999	0	2,166	12,313	100,497	139	115,115	0	135,809	(17,569)	2,855,522	4,301	2,978,063	(307,839)	2,670,224		
2000	0	2,346	(20,958)	135,533	145	117,066	0	115,895	(13,232)	3,471,397	5,182	3,579,242	(15,487)	3,563,755		
2001	0	2,784	1,301	95,335	196	99,616	0	222,144	(17,529)	1,903,742	1,978	2,110,335	86,928	2,197,263		
2002	0	2,534	(13,938)	123,577	146	112,319	0	225,032	36,404	2,805,631	4,672	3,071,739	(151,719)	2,920,020		
2003	0	2,920	(1,399)	132,714	131	134,366	0	227,713	(49,580)	3,198,537	11,362	3,387,032	328,334	3,715,366		
2004	0	2,982	(7,240)	125,928	150	121,820	0	40,711	(4,079)	2,979,173	1,337	3,017,142	146,888	3,164,030		
2005	0	2,823	(3,565)	108,136	154	107,548	0	120,419	(163,243)	3,667,721	1,270	3,626,167	571,155	4,197,322		
2006	0	2,989	(9,645)	118,272	169	111,785	0	16,877	(347,981)	3,571,009	1,208	3,241,113	80,098	3,321,211		
2007	0	2,840	14,928	134,172	146	152,086	0	65,369	186,420	2,720,400	830	2,973,019	(388,501)	2,584,518		
2008	0	3,270	185	147,228	400	151,686	0	101,686	178	3,610,797	8,660	3,721,321	(88,628)	3,632,693		
2009	0	3,270	185	151,621	400	155,476	0	101,686	182	3,623,622	8,660	3,734,150	69,276	3,803,426		
2010	0	3,351	0	154,691	400	158,442	0	128,523	4,288	3,637,801	8,660	3,779,272	182,790	3,962,242		
2011	0	3,351	0	156,071	400	159,822	0	128,364	64,678	3,637,687	8,660	3,839,389	137,242	3,976,631		
2012	0	3,351	0	157,377	400	161,128	0	128,100	(67,943)	3,638,993	8,660	3,707,810	(260,827)	3,446,983		
2013	0	3,351	0	194,669	400	198,420	0	128,264	9,749	3,697,705	8,660	3,844,378	145,525	3,989,903		
2014	0	3,351	0	202,566	400	206,317	0	130,280	16,625	4,066,455	8,660	4,222,020	(186,678)	4,035,342		
2015	0	3,351	0	202,566	400	206,317	0	130,445	32,003	4,066,455	8,660	4,237,563	(31,516)	4,206,047		
2016	0	3,351	0	202,566	400	206,317	0	128,415	(28,401)	4,066,455	8,660	4,175,129	205,134	4,380,263		
2017	0	3,351	0	202,566	400	206,317	0	128,602	61,309	4,066,455	8,660	4,265,026	119,885	4,384,911		
2018	0	3,351	0	201,045	400	204,796	0	128,369	(80,817)	4,064,934	8,660	4,121,146	(194,534)	3,926,612		
2019	0	3,351	0	202,566	400	206,317	0	128,613	50,179	4,066,455	8,660	4,253,907	77,224	4,331,131		
2020	0	3,351	0	202,566	400	206,317	0	128,690	(366)	4,066,455	8,660	4,203,439	(8,687)	4,194,752		
2021	0	3,351	0	202,566	400	206,317	0	128,769	10,725	4,066,455	8,660	4,214,609	(1,095)	4,213,514		
2022	0	3,351	0	202,566	400	206,317	0	128,846	(3,483)	4,066,455	8,660	4,200,478	(185,907)	4,014,571		
2023	0	3,351	0	202,566	400	206,317	0	128,818	(18,971)	4,066,455	8,660	4,184,962	115,791	4,300,753		
2024	0	3,351	0	202,566	400	206,317	0	128,625	11,289	4,066,455	8,660	4,215,029	79,858	4,294,887		
2025	0	3,351	0	202,566	400	206,317	0	130,380	(12,518)	4,066,455	8,660	4,192,977	(247,205)	3,945,772		
2026	0	3,351	0	202,566	400	206,317	0	128,700	24,308	4,066,455	8,660	4,228,123	246,850	4,474,973		
2027	0	3,351	0	202,566	400	206,317	0	128,692	(17,799)	4,066,455	8,660	4,186,008	(12,304)	4,173,704		
2028	0	3,351	0	202,566	400	206,317	0	128,783	12,291	4,066,455	8,660	4,216,189	15,430	4,231,619		
2029	0	3,351	0	202,566	400	206,317	0	128,671	(9,046)	4,066,455	8,660	4,194,740	(10,778)	4,183,962		
2030	0	3,351	0	202,566	400	206,317	0	128,777	20,756	4,066,455	8,660	4,224,648	124,586	4,349,234		
2031	0	3,351	0	202,566	400	206,317	0	128,134	(97,726)	4,066,455	8,660	4,105,523	(259,831)	3,845,692		
2032	0	3,351	0	202,566	400	206,317	0	128,005	84,999	4,066,455	8,660	4,288,119	138,527	4,426,646		
2033	0	3,351	0	202,566	400	206,317	0	127,876	(94,652)	4,066,455	8,660	4,108,339	(184,372)	3,923,967		
2034	0	3,351	0	202,566	400	206,317	0	127,725	69,593	4,066,455	8,660	4,272,433	120,375	4,392,808		
2035	0	3,351	0	202,566	400	206,317	0	127,379	(242,659)	4,066,455	8,660	3,959,835				

**TABLE B-6. Annual Water Quantities Conveyed through Each Pumping and Power Recovery Plant of Project Transportation Facilities**

(in acre-feet)

Sheet 3 of 10

Calendar Year	CALIFORNIA AQUEDUCT (continued)											
	San Luis Division						South San Joaquin Division					
	Dos Amigos Pumping Plant						Buena Vista Pumping Plant					
	Initial Fill Water	Operational Losses	Reservoir Storage Changes	Deliveries		Total	Initial Fill Water	Operational Losses	Reservoir Storage Changes	Deliveries		Total
Water Supply				Recreation	Water Supply					Recreation		
1961	[27] 0	[28] 0	[29] 0	[30] 0	[31] 0	[32] 0	[33] 0	[34] 0	[35] 0	[36] 0	[37] 0	[38] 0
1962	0	0	0	0	0	0	0	0	0	0	0	0
1963	0	0	0	0	0	0	0	0	0	0	0	0
1964	0	0	0	0	0	0	0	0	0	0	0	0
1965	0	0	0	0	0	0	0	0	0	0	0	0
1966	0	0	0	0	0	0	0	0	0	0	0	0
1967	0	0	0	0	0	0	0	0	0	0	0	0
1968	11,079	25,126	0	189,104	0	225,309	0	0	0	0	0	0
1969	3,887	9,922	0	192,689	0	206,498	0	0	0	0	0	0
1970	7,668	1,901	0	270,300	0	279,869	4,779	1,012	0	3	0	5,794
1971	23,207	(12,030)	0	545,869	0	557,046	7,853	8,399	0	101,512	0	117,764
1972	145,066	(6,635)	(6,558)	886,840	6,481	1,025,194	100,274	20,044	(6,558)	223,626	6,481	343,867
1973	214,941	(6,778)	1,329	635,716	1,147	846,355	204,638	35,695	1,329	311,096	1,147	553,905
1974	247,894	(16,765)	(15,295)	780,513	2,108	998,455	237,554	19,672	(15,295)	388,949	2,108	632,988
1975	110,149	(12,144)	(693)	1,126,152	3,358	1,226,822	103,352	26,342	(693)	672,531	3,358	804,890
1976	67,834	(456)	(152,171)	1,241,550	1,581	1,158,338	61,122	29,428	(152,171)	785,055	1,581	725,015
1977	0	26,359	(116,219)	463,970	737	374,847	0	25,173	(116,219)	271,944	560	181,458
1978	67,457	1,905	79,308	1,335,362	680	1,484,712	65,027	17,751	121,904	762,043	674	967,399
1979	17,397	33,884	(51,299)	1,530,926	685	1,531,593	12,302	46,157	(51,299)	737,714	502	745,376
1980	3,159	34,391	(272,825)	1,407,663	1,514	1,173,902	0	49,205	(134,009)	778,059	1,262	694,337
1981	46,060	36,962	23,359	1,775,179	4,348	1,885,908	0	38,942	23,359	1,077,322	4,112	1,143,735
1982	5,979	57,146	116,086	1,631,868	4,205	1,815,284	0	29,059	117,174	990,863	4,045	1,141,141
1983	6,071	63,583	(101,155)	1,085,804	7,475	1,061,778	0	40,205	(101,155)	593,820	7,291	540,261
1984	38,649	109,263	(112,744)	1,484,114	5,391	1,524,673	0	38,487	(114,984)	781,955	5,244	710,702
1985	0	86,772	138,898	1,858,111	4,936	2,068,717	0	42,838	139,689	992,606	4,804	1,179,937
1986	0	51,963	19,989	1,877,183	3,426	1,952,561	0	36,751	37,546	1,014,294	3,285	1,091,876
1987	0	64,827	(25,707)	1,978,945	7,121	2,025,186	0	30,495	(25,522)	1,027,361	6,937	1,039,271
1988	0	72,679	(34,592)	2,217,126	4,490	2,259,703	0	38,804	(29,747)	1,244,196	4,360	1,257,613
1989	0	90,090	(29,411)	2,679,845	7,652	2,748,176	0	29,594	(60,826)	1,532,625	7,490	1,508,883
1990	0	115,074	(11,323)	2,394,999	8,922	2,507,672	0	46,865	(15,092)	1,769,991	8,879	1,810,643
1991	0	92,227	9,325	489,348	4,605	595,505	0	39,274	96,506	446,916	4,560	587,256
1992	0	118,796	(225,603)	1,372,536	2,079	1,267,808	0	28,138	(98,271)	920,978	1,995	852,840
1993	0	136,432	(220,537)	2,170,494	1,864	2,088,253	0	14,186	(128,363)	908,200	1,676	796,699
1994	0	152,414	(78,957)	1,724,433	3,098	1,800,988	0	35,083	(68,211)	1,107,122	2,918	1,056,912
1995	0	137,937	(12,473)	1,921,666	1,711	2,048,841	0	33,963	(16,431)	706,742	1,669	725,943
1996	0	45,591	14,927	2,425,024	2,998	2,488,540	0	31,304	15,438	988,612	2,928	1,038,282
1997	527	107,033	(66,814)	2,247,628	2,090	2,290,464	0	42,670	40,852	1,054,461	2,076	1,140,059
1998	0	95,185	(338,076)	1,664,080	1,589	1,422,778	0	41,910	(106,487)	753,731	1,585	690,739
1999	0	95,262	(2,778)	2,750,154	3,285	2,845,923	0	48,502	(2,807)	1,131,826	3,279	1,180,800
2000	0	134,231	7,726	3,270,211	4,222	3,416,390	0	37,514	7,726	1,809,219	4,216	1,858,675
2001	0	150,830	(18,830)	1,615,422	1,218	1,748,640	0	31,361	(18,830)	1,318,987	1,211	1,332,729
2002	0	92,905	50,342	2,625,006	3,968	2,772,221	0	41,565	50,342	1,831,874	3,961	1,927,742
2003	0	85,360	(48,181)	2,879,993	10,656	2,927,828	0	43,352	(48,181)	1,985,852	10,645	1,991,668
2004	0	25,865	3,161	2,807,781	652	2,837,459	0	41,551	3,161	2,102,335	649	2,147,696
2005	0	62,569	(159,678)	3,425,322	581	3,328,794	0	35,019	(159,678)	1,848,012	559	1,723,912
2006	0	(2,205)	(130,258)	3,501,308	504	3,369,349	0	30,271	(120,122)	2,077,130	504	1,987,783
2007	0	56,193	109,739	2,452,077	312	2,618,321	0	43,400	118,196	2,005,912	305	2,167,813
2008	0	73,506	(7)	3,455,259	7,210	3,535,968	0	44,044	(7)	2,390,465	7,010	2,441,512
2009	0	73,506	(3)	3,463,291	7,210	3,544,004	0	44,044	(3)	2,236,830	7,010	2,287,881
2010	0	70,198	4,288	3,474,400	7,210	3,556,096	0	40,736	4,288	2,242,740	7,010	2,294,774
2011	0	70,389	64,678	3,472,906	7,210	3,615,183	0	40,927	64,678	2,242,246	7,010	2,354,861
2012	0	70,279	(67,943)	3,472,906	7,210	3,482,452	0	40,817	(67,943)	2,246,246	7,010	2,226,130
2013	0	70,217	9,749	3,494,323	7,210	3,581,499	0	40,755	9,749	2,193,558	7,010	2,251,072
2014	0	70,525	16,625	3,855,176	7,210	3,949,536	0	41,063	16,625	2,540,668	7,010	2,605,366
2015	0	70,654	32,003	3,855,176	7,210	3,965,043	0	41,192	32,003	2,540,668	7,010	2,620,873
2016	0	70,354	(28,401)	3,855,176	7,210	3,904,339	0	40,892	(28,401)	2,540,668	7,010	2,560,169
2017	0	70,586	61,309	3,855,176	7,210	3,994,281	0	41,124	61,309	2,540,668	7,010	2,850,111
2018	0	70,740	(80,817)	3,855,176	7,210	3,852,309	0	41,278	(80,817)	2,540,668	7,010	2,508,139
2019	0	70,564	50,179	3,855,176	7,210	3,983,129	0	41,102	50,179	2,540,668	7,010	2,638,959
2020	0	70,628	(366)	3,855,176	7,210	3,932,648	0	41,166	(366)	2,540,668	7,010	2,588,478
2021	0	70,711	10,725	3,855,176	7,210	3,943,822	0	41,249	10,725	2,540,668	7,010	2,599,652
2022	0	70,705	(3,483)	3,855,176	7,210	3,929,608	0	41,243	(3,483)	2,540,668	7,010	2,585,438
2023	0	70,696	(18,971)	3,855,176	7,210	3,914,111	0	41,234	(18,971)	2,540,668	7,010	2,569,941
2024	0	70,575	11,289	3,855,176	7,210	3,944,250	0	41,113	11,289	2,540,668	7,010	2,600,080
2025	0	70,638	(12,518)	3,855,176	7,210	3,920,506	0	41,176	(12,518)	2,540,668	7,010	2,576,336
2026	0	70,650	24,308	3,855,176	7,210	3,957,344	0	41,188	24,308	2,540,668	7,010	2,613,174
2027	0	70,563	(17,799)	3,855,176	7,210	3,915,150	0	41,101	(17,799)	2,540,668	7,010	2,570,980
2028	0	70,703	12,291	3,855,176	7,210	3,945,380	0	41,241	12,291	2,540,668	7,010	2,601,210
2029	0	70,630	(9,046)	3,855,176	7,210	3,923,970	0	41,168	(9,046)	2,540,668	7,010	2,579,800
2030	0	70,694	20,756	3,855,176	7,210	3,953,836	0	41,232	20,756	2,540,668	7,010	2,609,666
2031	0	70,566	(97,726)	3,855,176	7,210	3,835,226	0	41,104	(97,726)	2,540,668	7,010	2,491,056
2032	0	70,168	84,999	3,855,176	7,210	4,017,553	0	40,706	84,999	2,540,668	7,010	2,673,383
2033	0	70,373	(94,652)	3,855,176	7,210	3,838,107	0	40,911	(94,652)	2,540,668	7,010	2,493,937
2034	0	69,865	69,593	3,855,176	7,210	4,001,844	0	40,403	69,593	2,540,668	7,010	2,657,674
2035	0	69,205	(242,659)	3,855,176	7,210	3,688,932	0	39,743	(242,659)	2,540,668	7,010	2,344,762

**TABLE B-6. Annual Water Quantities Conveyed through Each Pumping and Power Recovery Plant of Project Transportation Facilities**

(in acre-feet)

Sheet 4 of 10

Calendar Year	CALIFORNIA AQUEDUCT (continued)											
	South San Joaquin Division (continued)											
	Teerink Pumping Plant						Chrisman Pumping Plant					
	Initial Fill Water	Operational Losses	Reservoir Storage Changes	Deliveries		Total	Initial Fill Water	Operational Losses	Reservoir Storage Changes	Deliveries		Total
Water Supply				Recreation	Water Supply					Recreation		
[39]	[40]	[41]	[42]	[43]	[44]	[45]	[46]	[47]	[48]	[49]	[50]	
1961	0	0	0	0	0	0	0	0	0	0	0	0
1962	0	0	0	0	0	0	0	0	0	0	0	0
1963	0	0	0	0	0	0	0	0	0	0	0	0
1964	0	0	0	0	0	0	0	0	0	0	0	0
1965	0	0	0	0	0	0	0	0	0	0	0	0
1966	0	0	0	0	0	0	0	0	0	0	0	0
1967	0	0	0	0	0	0	0	0	0	0	0	0
1968	0	0	0	0	0	0	0	0	0	0	0	0
1969	0	0	0	0	0	0	0	0	0	0	0	0
1970	198	2	0	0	0	200	0	0	0	0	0	0
1971	7,533	(112)	0	3,552	0	10,973	7,366	(159)	0	0	0	7,207
1972	100,274	12,765	(6,558)	84,955	6,481	197,917	100,274	13,160	(6,558)	78,891	6,481	192,248
1973	204,638	21,543	1,329	229,685	1,147	458,342	204,638	32,414	1,329	209,769	1,147	449,297
1974	237,554	11,843	(15,295)	336,198	2,108	572,408	237,554	17,655	(15,295)	318,198	2,108	560,220
1975	103,352	19,763	(693)	621,706	3,358	747,486	103,352	25,326	(693)	586,286	3,358	717,629
1976	61,122	18,552	(152,171)	740,486	1,581	669,570	61,122	21,468	(152,171)	700,935	1,581	632,935
1977	0	16,415	(116,219)	246,349	560	147,105	0	15,698	(116,219)	240,191	560	140,230
1978	65,027	28,200	121,904	631,121	674	847,546	65,027	26,705	121,904	599,973	674	814,283
1979	12,302	50,663	(51,299)	625,561	502	637,729	12,302	50,580	(51,299)	586,959	502	599,044
1980	0	48,825	(134,009)	696,405	1,262	612,483	0	58,085	(134,009)	658,588	1,262	583,926
1981	0	51,600	23,359	998,307	4,112	1,077,378	0	48,844	23,359	959,274	4,112	1,035,589
1982	0	44,353	(116,219)	878,486	4,045	1,044,216	0	33,541	117,277	830,704	4,045	985,567
1983	0	43,961	(101,155)	487,915	7,291	438,012	0	34,698	(101,155)	450,489	7,291	391,323
1984	0	45,999	(115,088)	632,262	5,244	568,417	0	33,132	(115,092)	582,414	5,244	505,698
1985	0	50,106	139,973	854,684	4,804	1,049,567	0	54,831	139,954	810,606	4,804	1,010,195
1986	0	38,747	37,546	882,300	3,285	961,878	0	41,421	37,546	839,839	3,285	922,091
1987	0	47,815	(25,522)	897,905	6,937	927,135	0	33,195	(25,522)	863,157	6,937	877,767
1988	0	53,815	(29,747)	1,097,643	4,360	1,126,071	0	39,775	(29,747)	1,055,649	4,360	1,070,037
1989	0	49,088	(60,826)	1,382,599	7,490	1,378,351	0	42,307	(60,826)	1,339,358	7,490	1,328,329
1990	0	66,868	(15,092)	1,627,246	8,879	1,687,901	0	56,663	(15,092)	1,590,893	8,879	1,641,343
1991	0	40,564	105,176	446,148	4,560	596,448	0	34,016	105,176	446,148	4,560	589,900
1992	0	31,820	(92,123)	844,376	1,995	786,068	0	34,477	(92,123)	820,133	1,995	784,482
1993	0	27,158	(127,738)	799,143	1,676	700,239	0	28,614	(127,738)	771,146	1,676	673,698
1994	0	50,802	(88,211)	1,007,214	2,918	972,723	0	57,203	(88,211)	977,703	2,918	949,613
1995	0	48,705	(16,431)	586,829	1,669	620,772	0	36,309	(16,431)	560,695	1,669	582,242
1996	0	58,437	15,438	836,819	2,928	913,622	0	43,710	15,438	800,633	2,928	862,709
1997	0	73,656	40,852	918,124	2,076	1,034,708	0	62,275	40,852	881,843	2,076	987,046
1998	0	61,137	(106,487)	656,796	1,585	613,031	0	47,523	(106,487)	628,084	1,585	570,705
1999	0	77,334	(2,807)	1,011,608	3,279	1,089,414	0	55,514	(2,807)	974,807	3,279	1,030,793
2000	0	87,084	7,726	1,685,654	4,216	1,784,680	0	49,690	7,726	1,645,591	4,216	1,707,223
2001	0	71,588	(18,830)	1,234,014	1,211	1,287,983	0	54,742	(18,830)	1,202,822	1,211	1,239,945
2002	0	108,309	50,342	1,740,813	3,961	1,903,425	0	69,443	50,342	1,699,261	3,961	1,823,007
2003	0	106,973	(48,181)	1,812,277	10,645	1,881,714	0	57,291	(48,181)	1,775,675	10,645	1,795,430
2004	0	122,559	3,161	2,032,492	649	2,158,861	0	60,847	3,161	1,992,308	649	2,056,965
2005	0	99,523	(159,678)	1,753,631	559	1,694,035	0	53,502	(159,678)	1,713,761	559	1,608,144
2006	0	128,022	(120,122)	1,967,163	504	1,975,567	0	46,463	(120,122)	1,920,919	504	1,847,764
2007	0	139,502	118,196	1,913,919	305	2,171,922	0	59,454	118,196	1,866,529	305	2,044,484
2008	0	40,414	(7)	2,271,665	7,010	2,319,082	0	40,164	(7)	2,219,865	7,010	2,267,032
2009	0	40,414	(3)	2,112,330	7,010	2,159,751	0	40,164	(3)	2,059,330	7,010	2,106,501
2010	0	37,106	4,288	2,118,240	7,010	2,166,644	0	36,856	4,288	2,065,240	7,010	2,113,394
2011	0	37,297	64,678	2,117,746	7,010	2,226,731	0	37,047	64,678	2,064,746	7,010	2,173,481
2012	0	37,187	(67,943)	2,121,746	7,010	2,098,000	0	36,937	(67,943)	2,068,746	7,010	2,044,750
2013	0	37,125	9,749	2,085,858	7,010	2,139,742	0	36,875	9,749	2,036,158	7,010	2,089,792
2014	0	37,433	16,625	2,432,968	7,010	2,494,036	0	37,183	16,625	2,383,268	7,010	2,444,086
2015	0	37,562	32,003	2,432,968	7,010	2,509,543	0	37,312	32,003	2,383,268	7,010	2,459,593
2016	0	37,262	(28,401)	2,432,968	7,010	2,448,839	0	37,012	(28,401)	2,383,268	7,010	2,398,889
2017	0	37,494	61,309	2,432,968	7,010	2,538,781	0	37,244	61,309	2,383,268	7,010	2,488,831
2018	0	37,648	(80,817)	2,432,968	7,010	2,396,809	0	37,398	(80,817)	2,383,268	7,010	2,346,859
2019	0	37,472	50,179	2,432,968	7,010	2,527,629	0	37,222	50,179	2,383,268	7,010	2,477,679
2020	0	37,536	(366)	2,432,968	7,010	2,477,148	0	37,286	(366)	2,383,268	7,010	2,427,198
2021	0	37,619	10,725	2,432,968	7,010	2,488,322	0	37,369	10,725	2,383,268	7,010	2,438,372
2022	0	37,613	(3,483)	2,432,968	7,010	2,474,108	0	37,363	(3,483)	2,383,268	7,010	2,424,158
2023	0	37,604	(18,971)	2,432,968	7,010	2,458,611	0	37,354	(18,971)	2,383,268	7,010	2,408,661
2024	0	37,483	11,289	2,432,968	7,010	2,488,750	0	37,233	11,289	2,383,268	7,010	2,438,800
2025	0	37,546	(12,518)	2,432,968	7,010	2,465,006	0	37,296	(12,518)	2,383,268	7,010	2,415,056
2026	0	37,558	24,308	2,432,968	7,010	2,501,844	0	37,308	24,308	2,383,268	7,010	2,451,894
2027	0	37,471	(17,799)	2,432,968	7,010	2,459,650	0	37,221	(17,799)	2,383,268	7,010	2,409,700
2028	0	37,611	12,291	2,432,968	7,010	2,489,880	0	37,361	12,291	2,383,268	7,010	2,439,930
2029	0	37,538	(9,046)	2,432,968	7,010	2,468,470	0	37,288	(9,046)	2,383,268	7,010	2,418,520
2030	0	37,602	20,756	2,432,968	7,010	2,498,336	0	37,352	20,756	2,383,268	7,010	2,448,386
2031	0	37,474	(97,726)	2,432,968	7,010	2,379,726	0	37,224	(97,726)	2,383,268	7,010	2,329,776
2032	0	37,076	84,999	2,432,968	7,010	2,562,053	0	36,826	84,999	2,383,268	7,010	2,512,103
2033	0	37,281	(94,652)	2,432,968	7,010	2,382,607	0	37,031	(94,652)	2,383,268	7,010	2,332,657
2034	0	36,773	69,593	2,432,968	7,010	2,546,344	0	36,523	69,593	2,383,268	7,010	2,496,394
2035	0	36,113	(242,659)	2,432,968	7,010	2,233,432	0	35,863	(242,659)	2,383,268	7,010	2,183,482

**TABLE B-6. Annual Water Quantities Conveyed through Each Pumping and Power Recovery Plant of Project Transportation Facilities**

(in acre-feet)

Sheet 5 of 10

Calendar  Year	CALIFORNIA AQUEDUCT (continued)											
	Tehachapi Division						Mojave Division					
	Edmonston Pumping Plant						Alamo Powerplant					
	Initial Fill Water	Opera- tional Losses	Reservoir Storage Changes	Deliveries		Total	Initial Fill Water	Opera- tional Losses	Reservoir Storage Changes	Deliveries		Total
Water Supply				Recrea- tion	Water Supply					Recrea- tion		
[51]	[52]	[53]	[54]	[55]	[56]	[57]	[58]	[59]	[60]	[61]	[62]	
1961	0	0	0	0	0	0	0	0	0	0	0	
1962	0	0	0	0	0	0	0	0	0	0	0	
1963	0	0	0	0	0	0	0	0	0	0	0	
1964	0	0	0	0	0	0	0	0	0	0	0	
1965	0	0	0	0	0	0	0	0	0	0	0	
1966	0	0	0	0	0	0	0	0	0	0	0	
1967	0	0	0	0	0	0	0	0	0	0	0	
1968	0	0	0	0	0	0	0	0	0	0	0	
1969	0	0	0	0	0	0	0	0	0	0	0	
1970	0	0	0	0	0	0	0	0	0	0	0	
1971	5,446	8	0	0	0	5,454	0	0	0	0	0	
1972	100,274	16,067	(6,558)	74,123	6,481	190,387	0	0	0	0	0	
1973	204,638	34,051	1,329	207,808	1,147	448,973	0	0	0	0	0	
1974	237,554	18,181	(15,295)	313,634	2,108	556,182	0	0	0	0	0	
1975	103,352	20,183	(693)	573,219	3,358	699,419	0	0	0	0	0	
1976	61,122	21,096	(152,171)	685,768	1,581	617,396	0	0	0	0	0	
1977	0	18,424	(116,219)	236,086	560	138,851	0	0	0	0	0	
1978	65,027	20,887	121,904	590,329	674	798,821	0	0	0	0	0	
1979	12,302	46,332	(51,299)	568,338	502	576,175	0	0	0	0	0	
1980	0	52,967	(134,009)	639,743	1,262	559,963	0	0	0	0	0	
1981	0	40,602	23,359	938,482	4,112	1,006,555	0	0	0	0	0	
1982	0	37,244	117,296	812,206	4,045	970,791	0	0	0	0	0	
1983	0	40,690	(101,155)	431,182	7,291	378,008	0	0	0	0	0	
1984	0	42,112	(115,214)	556,830	5,244	488,972	0	0	0	0	0	
1985	0	45,265	139,988	792,477	4,804	982,534	0	0	0	0	0	
1986	0	36,918	37,546	823,067	3,285	900,816	0	14,735	12,258	429,864	1,508	458,365
1987	0	29,580	(25,522)	851,322	6,937	862,317	0	11,665	(15,270)	417,870	1,239	415,504
1988	0	42,017	(29,747)	1,044,737	4,360	1,061,367	0	21,696	1,101	537,568	971	561,336
1989	0	32,270	(60,826)	1,328,041	7,490	1,306,975	0	4,686	(20,363)	716,360	1,407	702,090
1990	0	42,198	(15,092)	1,579,466	8,879	1,615,451	0	8,898	(5,916)	788,111	1,388	792,481
1991	0	33,999	105,176	441,217	4,560	584,952	0	17,908	34,422	177,308	394	230,032
1992	0	23,121	(92,123)	809,771	1,995	742,764	0	14,873	(17,115)	374,110	423	372,291
1993	0	11,946	(127,738)	759,485	1,676	645,369	0	9,304	(3,455)	308,222	443	314,514
1994	0	40,808	(88,211)	960,815	2,918	916,330	0	21,837	3,395	469,996	430	495,658
1995	0	36,001	(16,431)	542,465	1,669	563,704	0	14,139	(30,761)	384,836	427	368,641
1996	0	37,357	15,438	779,918	2,928	835,641	0	7,247	(11,410)	493,852	565	490,254
1997	0	51,475	40,852	860,798	2,076	955,201	0	20,725	38,960	537,586	507	597,778
1998	0	48,601	(106,487)	607,301	1,585	551,000	0	21,456	16,361	398,385	363	436,565
1999	0	52,726	(2,807)	947,420	3,279	1,000,618	0	26,644	(8,486)	589,756	396	608,310
2000	0	43,072	7,726	1,621,657	4,216	1,676,671	0	8,983	(10,472)	953,531	449	952,491
2001	0	39,544	(18,830)	1,187,452	1,211	1,209,377	0	14,526	3,478	710,137	452	728,593
2002	0	60,037	50,342	1,680,514	3,961	1,794,854	0	15,190	8,398	901,230	490	925,308
2003	0	53,320	(48,181)	1,757,708	10,645	1,773,492	0	13,676	(20,787)	1,022,009	355	1,015,253
2004	0	57,962	3,161	1,970,355	649	2,032,127	0	15,581	17,207	1,120,348	171	1,153,307
2005	0	40,949	(159,678)	1,695,241	559	1,577,071	0	2,561	(50,014)	1,117,990	84	1,070,621
2006	0	52,291	(120,122)	1,898,070	504	1,830,743	0	13,170	8,653	1,281,524	98	1,303,445
2007	0	65,423	118,196	1,840,096	305	2,024,020	0	17,957	(5,091)	1,374,646	103	1,092,315
2008	0	38,614	(7)	2,216,245	7,010	2,261,862	0	21,272	(81)	1,411,952	1,630	1,434,773
2009	0	38,614	(3)	2,055,540	7,010	2,101,161	0	21,272	(78)	1,358,817	1,630	1,381,641
2010	0	35,306	4,288	2,057,660	7,010	2,104,264	0	21,001	3,921	1,326,767	1,630	1,353,319
2011	0	35,497	64,678	2,060,956	7,010	2,168,141	0	20,971	26,001	1,329,063	1,630	1,377,665
2012	0	35,387	(67,943)	2,064,956	7,010	2,039,410	0	20,962	(41,797)	1,331,063	1,630	1,311,858
2013	0	35,325	9,749	2,009,498	7,010	2,061,582	0	20,835	4,742	1,252,024	1,630	1,279,231
2014	0	35,633	16,625	2,356,668	7,010	2,415,936	0	21,002	2,759	1,359,994	1,630	1,385,385
2015	0	35,762	32,003	2,356,668	7,010	2,431,443	0	21,066	22,604	1,359,994	1,630	1,405,294
2016	0	35,462	(28,401)	2,356,668	7,010	2,370,739	0	20,829	(21,084)	1,359,994	1,630	1,361,369
2017	0	35,694	61,309	2,356,668	7,010	2,460,681	0	20,895	33,266	1,359,994	1,630	1,415,785
2018	0	35,848	(80,817)	2,356,668	7,010	2,318,709	0	20,998	(50,078)	1,359,994	1,630	1,332,544
2019	0	35,672	50,179	2,356,668	7,010	2,449,529	0	20,924	31,508	1,359,994	1,630	1,414,056
2020	0	35,736	(366)	2,356,668	7,010	2,399,048	0	20,947	(3,398)	1,359,994	1,630	1,379,173
2021	0	35,819	10,725	2,356,668	7,010	2,410,222	0	20,946	(1,117)	1,359,994	1,630	1,381,453
2022	0	35,813	(3,483)	2,356,668	7,010	2,396,008	0	20,940	(3,434)	1,359,994	1,630	1,379,130
2023	0	35,804	(18,971)	2,356,668	7,010	2,380,511	0	20,939	(18,638)	1,359,994	1,630	1,363,925
2024	0	35,683	11,289	2,356,668	7,010	2,410,650	0	20,881	21,309	1,359,994	1,630	1,403,814
2025	0	35,746	(12,518)	2,356,668	7,010	2,386,906	0	20,965	(11,624)	1,359,994	1,630	1,370,965
2026	0	35,758	24,308	2,356,668	7,010	2,423,744	0	20,930	13,030	1,359,994	1,630	1,395,584
2027	0	35,671	(17,799)	2,356,668	7,010	2,381,550	0	20,861	(6,161)	1,359,994	1,630	1,376,324
2028	0	35,811	12,291	2,356,668	7,010	2,411,780	0	20,961	4,006	1,359,994	1,630	1,386,591
2029	0	35,738	(9,046)	2,356,668	7,010	2,390,370	0	20,955	(913)	1,359,994	1,630	1,381,666
2030	0	35,802	20,756	2,356,668	7,010	2,420,236	0	20,930	8,528	1,359,994	1,630	1,391,082
2031	0	35,674	(97,726)	2,356,668	7,010	2,301,626	0	20,956	(31,057)	1,359,994	1,630	1,351,523
2032	0	35,276	84,999	2,356,668	7,010	2,483,953	0	20,865	43,953	1,359,994	1,630	1,426,442
2033	0	35,481	(94,652)	2,356,668	7,010	2,304,507	0	20,854	(37,929)	1,359,994	1,630	1,344,549
2034	0	34,973	69,593	2,356,668	7,010	2,468,244	0	20,769	28,588	1,359,994	1,630	1,410,981
2035	0	34,313	(242,659)	2,356,668	7,010	2,155,332	0	20,892	(49,219)	1,359,994	1,630	1,333,297

**TABLE B-6. Annual Water Quantities Conveyed through Each Pumping and Power Recovery Plant of Project Transportation Facilities**

(in acre-feet)

Sheet 6 of 10

Calendar Year	CALIFORNIA AQUEDUCT (continued)											
	Mojave Division (continued)											
	Pearblossom Pumping Plant						Mojave Siphon Powerplant					
	Initial Fill Water	Operational Losses	Reservoir Storage Changes	Deliveries		Total	Initial Fill Water	Operational Losses	Reservoir Storage Changes	Deliveries		Total
[63]	[64]	[65]	Water Supply	Recreation	[68]	[69]	[70]	[71]	Water Supply	Recreation	[73]	[74]
1961	0	0	0	0	0	0	0	0	0	0	0	0
1962	0	0	0	0	0	0	0	0	0	0	0	0
1963	0	0	0	0	0	0	0	0	0	0	0	0
1964	0	0	0	0	0	0	0	0	0	0	0	0
1965	0	0	0	0	0	0	0	0	0	0	0	0
1966	0	0	0	0	0	0	0	0	0	0	0	0
1967	0	0	0	0	0	0	0	0	0	0	0	0
1968	0	0	0	0	0	0	0	0	0	0	0	0
1969	0	0	0	0	0	0	0	0	0	0	0	0
1970	0	0	0	0	0	0	0	0	0	0	0	0
1971	21	0	0	0	0	21	0	0	0	0	0	0
1972	35,243	5,282	(153)	1,794	0	42,166	0	0	0	0	0	0
1973	80,177	21,522	(2,700)	52,201	72	151,272	0	0	0	0	0	0
1974	76,694	10,847	(11,149)	102,839	44	179,275	0	0	0	0	0	0
1975	10,000	2,364	(8,397)	190,351	70	194,388	0	0	0	0	0	0
1976	4,168	7,040	(16,055)	236,713	152	232,018	0	0	0	0	0	0
1977	0	11,398	(17,534)	102,326	580	96,770	0	0	0	0	0	0
1978	19,922	5,696	69,130	374,845	498	470,091	0	0	0	0	0	0
1979	12,302	6,836	(32,518)	362,114	502	349,236	0	0	0	0	0	0
1980	0	16,200	6,159	401,214	781	424,354	0	0	0	0	0	0
1981	0	4,992	(36,278)	574,573	933	544,220	0	0	0	0	0	0
1982	0	5,251	55,232	401,037	1,919	463,439	0	0	0	0	0	0
1983	0	11,745	(26,847)	231,188	1,180	217,266	0	0	0	0	0	0
1984	0	18,228	23,230	252,066	1,494	295,018	0	0	0	0	0	0
1985	0	25,292	(2,815)	350,758	1,076	374,311	0	0	0	0	0	0
1986	0	30,876	12,258	394,156	1,508	438,798	0	0	0	0	0	0
1987	0	27,552	(15,270)	377,531	1,239	391,052	0	0	0	0	0	0
1988	0	32,209	1,101	501,300	971	535,581	0	1,977	1,101	501,291	971	505,340
1989	0	31,500	(20,363)	661,189	1,407	673,733	0	29,110	(20,363)	661,100	1,407	671,254
1990	0	32,672	(5,916)	730,560	1,388	758,704	0	23,692	(5,916)	730,550	1,388	749,714
1991	0	15,209	34,774	163,913	394	214,290	0	(543)	34,774	163,913	394	198,538
1992	0	13,989	(17,451)	338,249	423	335,210	0	(13,193)	(17,451)	338,207	423	307,986
1993	0	9,779	(3,455)	255,117	443	261,884	0	(11,922)	(3,455)	255,117	443	240,183
1994	0	150	3,395	409,928	430	413,903	0	1,601	3,395	395,294	430	400,720
1995	0	6,820	(29,282)	328,862	427	306,847	0	10,458	(29,282)	321,387	427	302,990
1996	0	9,514	(11,410)	424,252	565	422,921	0	(5,577)	(11,410)	418,141	565	401,719
1997	0	(1,124)	38,960	461,563	507	499,906	0	5,171	38,960	452,525	507	497,163
1998	0	(2,087)	16,361	334,965	363	349,602	0	11,496	16,361	332,385	363	360,605
1999	0	(1,154)	(8,486)	505,624	396	496,380	0	11,065	(8,486)	498,919	396	501,894
2000	0	(23,296)	(10,472)	859,533	449	826,214	0	4,896	(10,472)	849,514	449	844,387
2001	0	(9,304)	3,478	635,468	452	630,094	0	7,403	3,478	632,420	452	643,753
2002	0	3,810	8,398	823,690	490	836,388	0	9,300	8,398	820,217	490	838,405
2003	0	2,814	(20,787)	949,148	355	931,530	0	(6,586)	(20,787)	935,998	355	908,980
2004	0	(15,558)	17,207	1,047,485	171	1,049,305	0	5,034	17,207	1,035,279	171	1,057,691
2005	0	(18,967)	(50,014)	1,045,396	84	976,499	0	827	(50,014)	1,027,265	84	978,182
2006	0	(21,986)	8,653	1,187,627	98	1,174,392	0	(845)	8,653	987,593	98	995,499
2007	0	(13,055)	(5,091)	978,921	103	960,878	0	3,060	(5,091)	794,980	103	793,052
2008	0	15,922	(81)	1,318,267	1,430	1,335,538	0	12,452	(81)	554,237	1,430	568,038
2009	0	15,922	(78)	1,263,132	1,430	1,280,406	0	12,452	(78)	605,747	1,430	619,551
2010	0	15,651	3,921	1,231,082	1,430	1,252,084	0	12,181	3,921	1,231,082	1,430	1,248,614
2011	0	15,621	26,001	1,231,222	1,430	1,274,274	0	12,151	26,001	1,231,082	1,430	1,270,664
2012	0	15,612	(41,797)	1,231,342	1,430	1,206,587	0	12,142	(41,797)	1,231,082	1,430	1,202,857
2013	0	15,485	4,742	1,156,489	1,430	1,178,146	0	12,015	4,742	1,231,082	1,430	1,249,269
2014	0	15,652	2,759	1,193,759	1,430	1,213,600	0	12,182	2,759	1,231,082	1,430	1,247,453
2015	0	15,716	22,604	1,193,759	1,430	1,233,509	0	12,246	22,604	1,231,082	1,430	1,267,362
2016	0	15,479	(21,084)	1,193,759	1,430	1,189,584	0	12,009	(21,084)	1,231,082	1,430	1,223,437
2017	0	15,545	33,266	1,193,759	1,430	1,244,000	0	12,075	33,266	1,231,082	1,430	1,277,853
2018	0	15,648	(50,078)	1,193,759	1,430	1,160,759	0	12,178	(50,078)	1,231,082	1,430	1,194,612
2019	0	15,574	31,508	1,193,759	1,430	1,242,271	0	12,104	31,508	1,231,082	1,430	1,276,124
2020	0	15,597	(3,398)	1,193,759	1,430	1,207,388	0	12,127	(3,398)	1,231,082	1,430	1,241,241
2021	0	15,596	(1,117)	1,193,759	1,430	1,209,668	0	12,126	(1,117)	1,231,082	1,430	1,243,521
2022	0	15,590	(3,434)	1,193,759	1,430	1,207,345	0	12,120	(3,434)	1,231,082	1,430	1,241,198
2023	0	15,589	(18,638)	1,193,759	1,430	1,192,140	0	12,119	(18,638)	1,231,082	1,430	1,225,993
2024	0	15,531	21,309	1,193,759	1,430	1,232,029	0	12,061	21,309	1,231,082	1,430	1,265,882
2025	0	15,615	(11,624)	1,193,759	1,430	1,199,180	0	12,145	(11,624)	1,231,082	1,430	1,233,033
2026	0	15,580	13,030	1,193,759	1,430	1,223,799	0	12,110	13,030	1,231,082	1,430	1,257,652
2027	0	15,511	(6,161)	1,193,759	1,430	1,204,539	0	12,041	(6,161)	1,231,082	1,430	1,238,392
2028	0	15,611	4,006	1,193,759	1,430	1,214,806	0	12,141	4,006	1,231,082	1,430	1,248,659
2029	0	15,605	(913)	1,193,759	1,430	1,209,881	0	12,135	(913)	1,231,082	1,430	1,243,734
2030	0	15,580	8,528	1,193,759	1,430	1,219,297	0	12,110	8,528	1,231,082	1,430	1,253,150
2031	0	15,606	(31,057)	1,193,759	1,430	1,179,738	0	12,136	(31,057)	1,231,082	1,430	1,213,591
2032	0	15,515	43,953	1,193,759	1,430	1,254,657	0	12,045	43,953	1,231,082	1,430	1,288,510
2033	0	15,504	(37,929)	1,193,759	1,430	1,172,764	0	12,034	(37,929)	1,231,082	1,430	1,206,617
2034	0	15,419	28,588	1,193,759	1,430	1,239,196	0	11,949	28,588	1,231,082	1,430	1,273,049
2035	0	15,542	(49,219)	1,193,759	1,430	1,161,512	0	12,072	(49,219)	1,231,082	1,430	1,195,365

**TABLE B-6. Annual Water Quantities Conveyed through Each Pumping and Power Recovery Plant of Project Transportation Facilities**

(in acre-feet)

Sheet 7 of 10

Calendar  Year	CALIFORNIA AQUEDUCT (continued)									
	Santa Ana Division									
	Devil Canyon Powerplant					Greenspot Pumping Plant				
	Initial Fill Water	Opera- tional Losses	Reservoir Storage Changes	Deliveries		Total	Initial Fill Water	Opera- tional Losses	Water Supply Delivery	Total
Water Supply				Recrea- tion						
[75]	[76]	[77]	[78]	[79]	[80]	[81]	[82]	[83]	[84]	
1961	0	0	0	0	0	0	0	0	0	
1962	0	0	0	0	0	0	0	0	0	
1963	0	0	0	0	0	0	0	0	0	
1964	0	0	0	0	0	0	0	0	0	
1965	0	0	0	0	0	0	0	0	0	
1966	0	0	0	0	0	0	0	0	0	
1967	0	0	0	0	0	0	0	0	0	
1968	0	0	0	0	0	0	0	0	0	
1969	0	0	0	0	0	0	0	0	0	
1970	0	0	0	0	0	0	0	0	0	
1971	0	0	0	0	0	0	0	0	0	
1972	37	0	0	1,275	0	1,312	0	0	0	
1973	40,848	14,745	0	51,812	0	107,405	0	0	0	
1974	74,666	8,367	(4,925)	102,198	0	180,306	0	0	0	
1975	10,000	1,995	(6,719)	189,526	0	194,802	0	0	0	
1976	4,168	5,180	(9,182)	235,711	23	235,900	0	0	0	
1977	0	8,082	(5,235)	101,137	469	104,453	0	0	0	
1978	14,820	3,754	21,686	373,636	481	414,377	0	0	0	
1979	12,302	5,620	(27,107)	356,854	485	348,154	0	0	0	
1980	0	9,468	12,714	395,975	742	418,899	0	0	0	
1981	0	8,401	(23,448)	569,088	807	554,848	0	0	0	
1982	0	6,012	44,469	399,799	1,798	452,078	0	0	0	
1983	0	8,597	5,188	230,277	1,078	245,140	0	0	0	
1984	0	12,861	(850)	250,938	1,414	264,363	0	0	0	
1985	0	14,325	(8,791)	349,336	956	355,826	0	0	0	
1986	0	9,486	8,339	392,650	1,378	411,853	0	0	0	
1987	0	7,923	(11,335)	375,451	1,118	373,157	0	0	0	
1988	0	11,090	2,238	499,285	861	513,474	0	0	0	
1989	0	13,116	(5,487)	658,730	1,301	667,660	0	0	0	
1990	0	13,439	(4,622)	728,723	1,281	738,821	0	0	0	
1991	0	10,836	18,308	161,032	340	190,516	0	0	0	
1992	0	9,157	(9,084)	328,354	371	328,798	0	0	0	
1993	0	5,602	5,593	244,678	364	256,237	0	0	0	
1994	0	10,915	(11,045)	393,690	357	393,917	0	0	0	
1995	0	11,268	2,331	320,978	358	334,935	0	0	0	
1996	0	9,496	13,015	417,656	494	440,661	0	0	0	
1997	0	8,087	(19,685)	451,874	416	440,692	0	0	0	
1998	0	6,700	16,643	332,198	310	355,851	0	0	0	
1999	0	9,784	(4,177)	497,787	341	503,735	0	0	0	
2000	0	7,407	(11,040)	848,320	375	845,062	0	0	0	
2001	0	9,324	8,183	631,363	374	649,244	0	0	0	
2002	0	10,315	9,682	818,028	413	838,438	0	0	0	
2003	0	9,198	(18,298)	917,186	260	908,346	0	0	0	
2004	0	11,166	15,150	1,033,273	85	1,059,674	0	0	0	
2005	0	4,500	(63,441)	1,012,681	0	953,740	0	0	0	
2006	0	8,208	7,571	1,153,993	0	1,169,772	0	7,777	7,777	
2007	0	8,216	(5,872)	930,922	0	933,266	0	9,311	9,311	
2008	0	8,204	(81)	1,274,007	1,250	1,283,380	0	17,300	17,300	
2009	0	8,204	(78)	1,222,677	1,250	1,232,053	0	17,300	17,300	
2010	0	8,504	10,523	1,190,507	1,250	1,210,784	0	17,300	17,300	
2011	0	8,519	1,352	1,190,507	1,250	1,201,628	0	17,300	17,300	
2012	0	8,482	(22,894)	1,190,507	1,250	1,177,345	0	17,300	17,300	
2013	0	8,499	16,733	1,112,794	1,250	1,139,276	0	17,300	17,300	
2014	0	8,522	(4,585)	1,112,794	1,250	1,117,981	0	17,300	17,300	
2015	0	8,499	2,964	1,112,794	1,250	1,125,507	0	17,300	17,300	
2016	0	8,483	(1,269)	1,112,794	1,250	1,121,258	0	17,300	17,300	
2017	0	8,502	9,828	1,112,794	1,250	1,132,374	0	17,300	17,300	
2018	0	8,484	(19,777)	1,112,794	1,250	1,102,751	0	17,300	17,300	
2019	0	8,492	17,408	1,112,794	1,250	1,139,944	0	17,300	17,300	
2020	0	8,483	(17,305)	1,112,794	1,250	1,105,222	0	17,300	17,300	
2021	0	8,486	(398)	1,112,794	1,250	1,122,132	0	17,300	17,300	
2022	0	8,486	13,735	1,112,794	1,250	1,136,265	0	17,300	17,300	
2023	0	8,482	(8,417)	1,112,794	1,250	1,114,109	0	17,300	17,300	
2024	0	8,462	689	1,112,794	1,250	1,123,195	0	17,300	17,300	
2025	0	8,489	4,591	1,112,794	1,250	1,127,124	0	17,300	17,300	
2026	0	8,475	(3,819)	1,112,794	1,250	1,118,700	0	17,300	17,300	
2027	0	8,479	745	1,112,794	1,250	1,123,268	0	17,300	17,300	
2028	0	8,481	(5,355)	1,112,794	1,250	1,117,170	0	17,300	17,300	
2029	0	8,481	2,909	1,112,794	1,250	1,125,434	0	17,300	17,300	
2030	0	8,480	296	1,112,794	1,250	1,122,820	0	17,300	17,300	
2031	0	8,475	(1,976)	1,112,794	1,250	1,120,543	0	17,300	17,300	
2032	0	8,449	18,821	1,112,794	1,250	1,141,314	0	17,300	17,300	
2033	0	8,449	(23,419)	1,112,794	1,250	1,099,074	0	17,300	17,300	
2034	0	8,443	21,651	1,112,794	1,250	1,144,138	0	17,300	17,300	
2035	0	8,451	(31,434)	1,112,794	1,250	1,091,061	0	17,300	17,300	

**TABLE B-6. Annual Water Quantities Conveyed through Each Pumping and Power Recovery Plant of Project Transportation Facilities**

(in acre-feet)

Sheet 8 of 10

Calendar Year	CALIFORNIA AQUEDUCT (continued)														
	Santa Ana Division (continued)								West Branch, California Aqueduct						
	Crafton Hills Pumping Plant				Cherry Valley Pumping Plant				Oso Pumping Plant						
	Initial Fill Water	Operational Losses	Water Supply Delivery	Total	Initial Fill Water	Operational Losses	Water Supply Delivery	Total	Initial Fill Water	Operational Losses	Reservoir Storage Changes	Deliveries		Total	
[85]	[86]	[87]	[88]	[89]	[90]	[91]	[92]	[93]	[94]	[95]	[96]	[97]	[98]		
1961	0	0	0	0	0	0	0	0	0	0	0	0	0	0	
1962	0	0	0	0	0	0	0	0	0	0	0	0	0	0	
1963	0	0	0	0	0	0	0	0	0	0	0	0	0	0	
1964	0	0	0	0	0	0	0	0	0	0	0	0	0	0	
1965	0	0	0	0	0	0	0	0	0	0	0	0	0	0	
1966	0	0	0	0	0	0	0	0	0	0	0	0	0	0	
1967	0	0	0	0	0	0	0	0	0	0	0	0	0	0	
1968	0	0	0	0	0	0	0	0	0	0	0	0	0	0	
1969	0	0	0	0	0	0	0	0	0	0	0	0	0	0	
1970	0	0	0	0	0	0	0	0	0	0	0	0	0	0	
1971	0	0	0	0	0	0	0	0	2,444	133	0	0	0	2,577	
1972	0	0	0	0	0	0	0	0	63,883	6,557	(6,405)	71,991	6,481	142,507	
1973	0	0	0	0	0	0	0	0	124,461	16,995	4,029	155,317	1,075	301,877	
1974	0	0	0	0	0	0	0	0	160,860	12,702	(4,146)	209,172	2,064	380,652	
1975	0	0	0	0	0	0	0	0	93,352	23,008	7,704	374,306	3,288	501,658	
1976	0	0	0	0	0	0	0	0	56,954	15,845	(136,116)	420,708	1,429	358,820	
1977	0	0	0	0	0	0	0	0	0	4,407	(98,685)	122,447	(20)	28,149	
1978	0	0	0	0	0	0	0	0	45,105	9,061	52,774	171,139	176	278,255	
1979	0	0	0	0	0	0	0	0	0	25,355	(18,781)	145,598	0	152,172	
1980	0	0	0	0	0	0	0	0	0	24,576	(140,168)	165,931	481	50,820	
1981	0	0	0	0	0	0	0	0	0	15,254	59,637	283,264	3,179	361,334	
1982	0	0	0	0	0	0	0	0	0	23,824	61,685	360,878	2,126	448,513	
1983	0	0	0	0	0	0	0	0	0	23,601	(74,308)	166,995	6,111	122,399	
1984	0	0	0	0	0	0	0	0	0	12,461	(138,146)	272,101	3,750	150,166	
1985	0	0	0	0	0	0	0	0	0	28,257	142,219	403,097	3,728	577,301	
1986	0	0	0	0	0	0	0	0	0	22,387	25,288	393,203	1,777	442,655	
1987	0	0	0	0	0	0	0	0	0	18,164	(10,252)	433,452	5,698	447,062	
1988	0	0	0	0	0	0	0	0	0	20,461	(30,848)	507,169	3,389	500,171	
1989	0	0	0	0	0	0	0	0	0	27,914	(40,463)	611,681	6,083	605,215	
1990	0	0	0	0	0	0	0	0	0	33,666	(9,176)	791,355	7,491	823,336	
1991	0	0	0	0	0	0	0	0	0	16,460	70,754	263,909	4,166	355,289	
1992	0	0	0	0	0	0	0	0	0	8,238	(75,008)	435,661	1,572	370,463	
1993	0	0	0	0	0	0	0	0	0	2,674	(124,283)	451,263	1,233	330,887	
1994	0	0	0	0	0	0	0	0	0	18,688	(91,606)	490,819	2,488	420,389	
1995	0	0	0	0	0	0	0	0	0	21,775	14,330	157,629	1,242	194,976	
1996	0	0	0	0	0	0	0	0	0	30,121	26,848	286,066	2,363	345,398	
1997	0	0	0	0	0	0	0	0	0	30,468	1,892	323,212	1,569	357,141	
1998	0	0	0	0	0	0	0	0	0	26,851	(122,848)	208,916	1,222	114,141	
1999	0	0	0	0	0	0	0	0	0	25,690	5,679	357,664	2,883	391,916	
2000	0	0	0	0	0	0	0	0	0	33,658	18,198	668,126	3,767	723,749	
2001	0	0	0	0	0	0	0	0	0	24,551	(22,308)	477,315	759	480,317	
2002	0	0	0	0	0	0	0	0	0	44,692	41,944	779,284	3,471	869,391	
2003	0	0	0	0	0	0	0	0	0	39,495	(27,394)	735,699	10,290	758,090	
2004	0	0	0	0	0	0	0	0	0	41,947	(14,046)	850,007	478	878,386	
2005	0	0	0	0	0	0	0	0	0	38,154	(109,664)	577,251	475	506,216	
2006	0	0	6,892	6,892	0	0	4,278	4,278	0	36,732	(128,775)	616,546	406	524,909	
2007	0	0	6,181	6,181	0	0	4,009	4,009	0	45,368	123,287	760,750	202	929,607	
2008	0	0	17,300	17,300	0	0	17,300	17,300	0	17,292	74	804,293	5,380	827,039	
2009	0	0	17,300	17,300	0	0	17,300	17,300	0	17,292	75	696,723	5,380	719,470	
2010	0	0	17,300	17,300	0	0	17,300	17,300	0	14,255	367	730,893	5,380	750,895	
2011	0	0	17,300	17,300	0	0	17,300	17,300	0	14,476	38,677	731,893	5,380	790,426	
2012	0	0	17,300	17,300	0	0	17,300	17,300	0	14,375	(26,146)	733,893	5,380	727,502	
2013	0	0	17,300	17,300	0	0	17,300	17,300	0	14,440	5,007	757,474	5,380	782,301	
2014	0	0	17,300	17,300	0	0	17,300	17,300	0	14,581	13,866	996,674	5,380	1,030,501	
2015	0	0	17,300	17,300	0	0	17,300	17,300	0	14,646	9,399	996,674	5,380	1,026,099	
2016	0	0	17,300	17,300	0	0	17,300	17,300	0	14,583	(7,317)	996,674	5,380	1,009,320	
2017	0	0	17,300	17,300	0	0	17,300	17,300	0	14,749	28,043	996,674	5,380	1,044,846	
2018	0	0	17,300	17,300	0	0	17,300	17,300	0	14,800	(30,739)	996,674	5,380	996,115	
2019	0	0	17,300	17,300	0	0	17,300	17,300	0	14,698	18,671	996,674	5,380	1,035,423	
2020	0	0	17,300	17,300	0	0	17,300	17,300	0	14,739	3,032	996,674	5,380	1,019,825	
2021	0	0	17,300	17,300	0	0	17,300	17,300	0	14,823	11,842	996,674	5,380	1,028,719	
2022	0	0	17,300	17,300	0	0	17,300	17,300	0	14,823	(49)	996,674	5,380	1,016,828	
2023	0	0	17,300	17,300	0	0	17,300	17,300	0	14,815	(333)	996,674	5,380	1,016,536	
2024	0	0	17,300	17,300	0	0	17,300	17,300	0	14,752	(10,020)	996,674	5,380	1,006,786	
2025	0	0	17,300	17,300	0	0	17,300	17,300	0	14,731	(894)	996,674	5,380	1,015,891	
2026	0	0	17,300	17,300	0	0	17,300	17,300	0	14,778	11,278	996,674	5,380	1,028,110	
2027	0	0	17,300	17,300	0	0	17,300	17,300	0	14,760	(11,638)	996,674	5,380	1,005,176	
2028	0	0	17,300	17,300	0	0	17,300	17,300	0	14,800	8,285	996,674	5,380	1,025,139	
2029	0	0	17,300	17,300	0	0	17,300	17,300	0	14,733	(8,133)	996,674	5,380	1,008,654	
2030	0	0	17,300	17,300	0	0	17,300	17,300	0	14,822	12,228	996,674	5,380	1,029,104	
2031	0	0	17,300	17,300	0	0	17,300	17,300	0	14,668	(66,669)	996,674	5,380	950,053	
2032	0	0	17,300	17,300	0	0	17,300	17,300	0	14,361	41,046	996,674	5,380	1,057,461	
2033	0	0	17,300	17,300	0	0	17,300	17,300	0	14,577	(56,723)	996,674	5,380	999,908	
2034	0	0	17,300	17,300	0	0	17,300	17,300	0	14,154	41,005	996,674	5,380	1,057,213	
2035	0	0	17,300	17,300	0	0	17,300	17,300	0	13,371	(193,440)	996,674	5,380	821,985	

**TABLE B-6. Annual Water Quantities Conveyed through Each Pumping and Power Recovery Plant of Project Transportation Facilities**

(in acre-feet)

Sheet 9 of 10

Calendar  Year	CALIFORNIA AQUEDUCT (continued)											
	West Branch, California Aqueduct (continued)											
	Warne Powerplant						Castaic Powerplant					
	Initial Fill Water	Opera- tional Losses	Reservoir Storage Changes	Deliveries		Total	Initial Fill Water	Opera- tional Losses	Reservoir Storage Changes	Deliveries		Total
Water Supply				Recrea- tion	Water Supply					Recrea- tion		
[99]	[100]	[101]	[102]	[103]	[104]	[105]	[106]	[107]	[108]	[109]	[110]	
1961	0	0	0	0	0	0	0	0	0	0	0	
1962	0	0	0	0	0	0	0	0	0	0	0	
1963	0	0	0	0	0	0	0	0	0	0	0	
1964	0	0	0	0	0	0	0	0	0	0	0	
1965	0	0	0	0	0	0	0	0	0	0	0	
1966	0	0	0	0	0	0	0	0	0	0	0	
1967	0	0	0	0	0	0	0	0	0	0	0	
1968	0	0	0	0	0	0	0	0	0	0	0	
1969	0	0	0	0	0	0	0	0	0	0	0	
1970	0	0	0	0	0	0	0	0	0	0	0	
1971	0	0	0	0	0	0	0	0	0	0	0	
1972	0	0	0	0	0	57,364	1,788	(6,162)	71,938	6,481	131,409	
1973	0	0	0	0	0	37,198	6,430	4,542	155,297	1,075	204,542	
1974	0	0	0	0	0	82,364	1,772	(950)	209,136	541	292,863	
1975	0	0	0	0	0	90,460	5,002	(1,534)	374,280	1,563	469,771	
1976	0	0	0	0	0	55,990	(7,695)	(132,036)	420,684	1,429	338,372	
1977	0	0	0	0	0	0	(1,485)	(102,532)	122,447	(20)	18,410	
1978	0	0	0	0	0	45,105	(2,264)	129,523	171,139	176	343,679	
1979	0	0	0	0	0	0	(2,339)	(20,400)	145,598	0	122,859	
1980	0	0	0	0	0	0	991	(118,026)	165,931	481	49,377	
1981	0	0	0	0	0	0	(44,416)	47,244	283,264	2,704	288,796	
1982	0	24,468	61,169	360,878	2,126	448,641	(60,135)	59,069	360,878	1,187	360,999	
1983	0	20,780	(74,308)	166,995	6,111	119,578	(33,418)	(46,904)	166,995	2,618	89,291	
1984	0	13,572	(139,219)	275,212	2,208	151,773	(29,618)	(139,545)	275,212	2,201	108,250	
1985	0	29,286	141,492	403,097	874	574,749	(4,622)	135,007	403,097	844	534,326	
1986	0	21,579	25,288	393,203	1,777	441,847	(6,664)	21,520	393,203	623	408,682	
1987	0	20,885	(10,252)	433,452	5,698	449,783	(519)	(6,241)	433,452	2,734	429,426	
1988	0	23,253	(31,453)	507,169	3,389	502,358	12,650	(28,498)	507,169	1,359	492,680	
1989	0	27,131	(40,463)	611,681	6,083	604,432	634	(40,154)	611,681	3,161	575,322	
1990	0	34,208	(9,176)	791,355	7,491	823,878	(14,012)	(15,101)	786,519	3,419	760,825	
1991	0	16,908	70,754	263,909	4,166	355,737	(871)	89,637	262,921	2,283	353,970	
1992	0	9,638	(75,008)	435,661	1,572	371,863	(609)	(71,795)	435,661	1,543	364,800	
1993	0	1,922	(124,283)	451,257	1,233	330,129	21,959	(77,428)	451,257	1,211	396,999	
1994	0	23,151	(91,606)	490,819	2,488	424,852	5,205	(95,738)	490,819	2,465	402,751	
1995	0	15,860	14,330	157,629	1,242	189,061	20,400	75,863	157,629	1,223	255,115	
1996	0	21,191	26,848	286,066	2,363	336,468	(5,621)	19,088	286,066	2,362	301,895	
1997	0	23,437	1,892	323,201	1,569	350,099	0	11,119	(1,802)	323,201	1,566	334,084
1998	0	26,864	(122,848)	208,909	1,222	114,147	24,544	(57,726)	208,909	1,222	176,949	
1999	0	21,822	8,120	357,664	2,883	390,489	(3,670)	6,280	357,664	2,865	363,139	
2000	0	27,237	18,198	668,126	3,767	717,328	(19,645)	9,320	665,926	1,556	657,157	
2001	0	17,404	(22,308)	477,315	759	473,170	(5,949)	(16,588)	477,315	746	455,524	
2002	0	35,058	41,944	779,284	3,471	859,757	0	10,071	35,623	776,136	305	822,135
2003	0	28,167	(27,394)	735,699	10,290	746,762	0	9,075	(17,034)	732,549	356	724,946
2004	0	31,034	(14,046)	850,007	478	867,473	0	9,120	(11,440)	845,960	456	844,096
2005	0	29,111	(109,664)	577,251	475	497,173	0	21,155	(61,490)	577,251	472	537,388
2006	0	23,453	(128,775)	616,546	406	511,630	0	4,173	(121,607)	616,546	396	499,508
2007	0	29,978	123,287	760,750	202	914,217	0	(1,664)	117,880	758,860	196	875,272
2008	0	15,382	74	804,293	5,380	825,129	0	9,657	74	801,143	2,330	813,204
2009	0	15,382	75	696,723	5,380	717,560	0	9,657	75	693,573	2,330	705,635
2010	0	12,345	367	730,893	5,380	748,985	0	6,060	367	727,743	2,330	736,500
2011	0	12,566	38,677	731,893	5,380	788,516	0	6,281	38,677	728,743	2,330	776,031
2012	0	12,465	(26,146)	733,893	5,380	725,592	0	6,180	(26,146)	730,743	2,330	713,107
2013	0	12,530	5,007	757,474	5,380	780,391	0	6,245	5,007	754,324	2,330	767,906
2014	0	12,671	13,866	996,674	5,380	1,028,591	0	6,386	13,866	993,524	2,330	1,016,106
2015	0	12,736	9,399	996,674	5,380	1,024,189	0	6,451	9,399	993,524	2,330	1,011,704
2016	0	12,673	(7,317)	996,674	5,380	1,007,410	0	6,388	(7,317)	993,524	2,330	994,925
2017	0	12,839	28,043	996,674	5,380	1,042,936	0	6,554	28,043	993,524	2,330	1,030,451
2018	0	12,890	(30,739)	996,674	5,380	984,205	0	6,605	(30,739)	993,524	2,330	971,720
2019	0	12,788	18,671	996,674	5,380	1,033,513	0	6,503	18,671	993,524	2,330	1,021,028
2020	0	12,829	3,032	996,674	5,380	1,017,915	0	6,544	3,032	993,524	2,330	1,005,430
2021	0	12,913	11,842	996,674	5,380	1,026,809	0	6,628	11,842	993,524	2,330	1,014,324
2022	0	12,913	(49)	996,674	5,380	1,014,918	0	6,628	(49)	993,524	2,330	1,002,433
2023	0	12,905	(333)	996,674	5,380	1,014,626	0	6,620	(333)	993,524	2,330	1,002,141
2024	0	12,842	(10,020)	996,674	5,380	1,004,876	0	6,557	(10,020)	993,524	2,330	992,391
2025	0	12,821	(894)	996,674	5,380	1,013,981	0	6,536	(894)	993,524	2,330	1,001,496
2026	0	12,868	11,278	996,674	5,380	1,026,200	0	6,583	11,278	993,524	2,330	1,013,715
2027	0	12,850	(11,638)	996,674	5,380	1,003,266	0	6,565	(11,638)	993,524	2,330	990,781
2028	0	12,890	8,285	996,674	5,380	1,023,229	0	6,605	8,285	993,524	2,330	1,010,744
2029	0	12,823	(8,133)	996,674	5,380	1,006,744	0	6,538	(8,133)	993,524	2,330	994,259
2030	0	12,912	12,228	996,674	5,380	1,027,194	0	6,627	12,228	993,524	2,330	1,014,709
2031	0	12,758	(66,669)	996,674	5,380	948,143	0	6,473	(66,669)	993,524	2,330	935,658
2032	0	12,451	41,046	996,674	5,380	1,055,551	0	6,166	41,046	993,524	2,330	1,043,066
2033	0	12,667	(56,723)	996,674	5,380	957,998	0	6,382	(56,723)	993,524	2,330	945,513
2034	0	12,244	41,005	996,674	5,380	1,055,303	0	5,959	41,005	993,524	2,330	1,042,818
2035	0	11,461	(193,440)	996,674	5,380	820,075	0	5,176	(193,440)	993,524	2,330	807,590



**TABLE B-6. Annual Water Quantities Conveyed through Each Pumping and Power Recovery Plant of Project Transportation Facilities**

(in acre-feet)

Sheet 10 of 10

Calendar Year	CALIFORNIA AQUEDUCT (continued)							
	Coastal Branch, California Aqueduct							
	Las Perillas and Badger Hill Pumping Plants				Devil's Den, Bluestone, and Polonio Pass Pumping Plants			
	Initial Fill Water	Operational Losses	Water Supply Delivery	Total	Initial Fill Water	Operational Losses	Water Supply Delivery	Total
[111]	[112]	[113]	[114]	[115]	[116]	[117]	[118]	
1961	0	0	0	0	0	0	0	0
1962	0	0	0	0	0	0	0	0
1963	0	0	0	0	0	0	0	0
1964	0	0	0	0	0	0	0	0
1965	0	0	0	0	0	0	0	0
1966	0	0	0	0	0	0	0	0
1967	0	0	0	0	0	0	0	0
1968	210	873	79,039	80,122	210	0	0	210
1969	0	1,042	62,064	63,106	0	0	0	0
1970	0	638	83,649	84,287	0	0	0	0
1971	0	3,455	110,971	114,426	0	0	0	0
1972	0	1,745	121,755	123,500	0	0	0	0
1973	0	5,479	78,645	84,124	0	0	0	0
1974	0	7,344	78,174	85,518	0	0	0	0
1975	0	5,819	85,216	91,035	0	0	0	0
1976	0	6,562	90,058	96,620	0	0	0	0
1977	0	5,777	40,579	46,356	0	0	0	0
1978	0	9,085	92,604	101,689	0	0	0	0
1979	0	10,896	123,155	134,051	0	0	0	0
1980	0	9,449	111,379	120,828	0	0	0	0
1981	0	13,232	109,754	122,986	0	0	0	0
1982	0	7,984	95,776	103,760	0	0	0	0
1983	0	5,710	100,518	106,228	0	0	0	0
1984	0	5,740	126,387	132,127	0	0	0	0
1985	0	7,563	120,823	128,386	0	0	0	0
1986	0	8,719	131,599	140,318	0	0	0	0
1987	0	11,363	128,080	139,443	0	0	0	0
1988	0	12,831	120,969	133,800	0	0	0	0
1989	0	11,454	116,801	128,255	0	0	0	0
1990	0	13,022	109,802	122,824	0	0	0	0
1991	0	5,802	1,496	7,298	0	0	0	0
1992	0	7,893	79,635	87,528	0	0	0	0
1993	0	9,282	94,921	104,203	0	0	0	0
1994	0	8,515	87,158	95,673	0	0	0	0
1995	0	6,986	94,536	101,522	0	0	0	0
1996	0	9,663	114,630	124,293	0	0	0	0
1997	527	8,343	110,428	119,298	527	0	8,538	9,065
1998	0	8,415	109,400	117,815	0	0	22,210	22,210
1999	0	2,453	120,061	122,514	0	303	23,880	24,183
2000	0	(429)	122,652	122,223	0	0	26,703	26,703
2001	0	(742)	87,915	87,173	0	0	23,229	23,229
2002	0	638	99,783	100,421	0	(151)	31,991	31,840
2003	0	161	101,113	101,274	0	284	31,421	31,705
2004	0	492	104,144	104,636	0	480	33,870	34,350
2005	0	1,484	103,178	104,662	0	573	27,595	28,168
2006	0	802	115,433	116,235	0	2,034	27,484	29,518
2007	0	802	131,590	132,392	0	293	31,516	31,809
2008	0	802	152,474	153,276	0	212	55,569	55,781
2009	0	802	168,891	169,693	0	212	70,486	70,698
2010	0	802	168,891	169,693	0	212	70,486	70,698
2011	0	802	168,891	169,693	0	212	70,486	70,698
2012	0	802	168,891	169,693	0	212	70,486	70,698
2013	0	802	164,391	165,193	0	212	70,486	70,698
2014	0	802	164,391	165,193	0	212	70,486	70,698
2015	0	802	164,391	165,193	0	212	70,486	70,698
2016	0	802	164,391	165,193	0	212	70,486	70,698
2017	0	802	164,391	165,193	0	212	70,486	70,698
2018	0	802	164,391	165,193	0	212	70,486	70,698
2019	0	802	164,391	165,193	0	212	70,486	70,698
2020	0	802	164,391	165,193	0	212	70,486	70,698
2021	0	802	164,391	165,193	0	212	70,486	70,698
2022	0	802	164,391	165,193	0	212	70,486	70,698
2023	0	802	164,391	165,193	0	212	70,486	70,698
2024	0	802	164,391	165,193	0	212	70,486	70,698
2025	0	802	164,391	165,193	0	212	70,486	70,698
2026	0	802	164,391	165,193	0	212	70,486	70,698
2027	0	802	164,391	165,193	0	212	70,486	70,698
2028	0	802	164,391	165,193	0	212	70,486	70,698
2029	0	802	164,391	165,193	0	212	70,486	70,698
2030	0	802	164,391	165,193	0	212	70,486	70,698
2031	0	802	164,391	165,193	0	212	70,486	70,698
2032	0	802	164,391	165,193	0	212	70,486	70,698
2033	0	802	164,391	165,193	0	212	70,486	70,698
2034	0	802	164,391	165,193	0	212	70,486	70,698
2035	0	802	164,391	165,193	0	212	70,486	70,698

**TABLE B-7. Reconciliation of Capital Costs Allocated to Water Supply and Power Generation**

(Thousands of Dollars)

Item	Project Costs Allocated to Water Supply and Power Generation							Capital Costs Allocated to Other Purposes	Total State Water Project Capital Cost
	Misc. Income Credited to Construction (a)	Allowance for Future Price Escalation (b)	Costs of Construction of Delivery Structures (c)	Costs of Requested Excess Capacity and Future Enlargement (d)	Capital Cost Component of Delta Water Charge (e)	Capital Cost Component of Transportation Water Charge (f)	Water Supply and Power Total (g)		
	[1]	[2]	[3]	[4]	[5]	[6]	[7]	[8]	[9]
<b>CONSERVATION FACILITIES</b>									
Upper Feather Division									
Frenchman Dam & Lake	180	0	0	0	601	0	781	2,876	3,657
Grizzly Valley Dam & Lake Davis	65	0	0	0	0	0	65	9,338	9,403
Antelope Dam & Lake	1	0	0	0	0	0	1	5,863	5,864
Abbey Bridge Dam & Reservoir	0	0	0	0	0	0	0	520	520
Dixie Refuge Dam & Reservoir	0	0	0	0	0	0	0	236	236
<b>Total, Upper Feather Division</b>	<b>246</b>	<b>0</b>	<b>0</b>	<b>0</b>	<b>601</b>	<b>0</b>	<b>847</b>	<b>18,833</b>	<b>19,680</b>
Oroville Division									
Multipurpose Facilities	47,846	0	0	0	409,096	0	456,942	95,037	551,979
Specific Power Facilities	230	0	0	0	102,455	0	102,685	(1,110)	101,575
<b>Total, Oroville Division</b>	<b>48,076</b>	<b>0</b>	<b>0</b>	<b>0</b>	<b>511,551</b>	<b>0</b>	<b>559,627</b>	<b>93,927</b>	<b>653,554</b>
California Aqueduct									
North San Joaquin Division	1,210	0	0	0	80,788	0	81,998	2,595	84,593
San Luis Division	13,152	0	0	0	105,052	0	118,204	4,490	122,694
<b>Total, California Aqueduct</b>	<b>14,362</b>	<b>0</b>	<b>0</b>	<b>0</b>	<b>185,840</b>	<b>0</b>	<b>200,202</b>	<b>7,085</b>	<b>207,287</b>
Delta Facilities	37,311	0	0	0	326,783	0	364,094	15,118	379,212
Planning and Pre-Operation	5,302	0	0	0	57,086	0	62,388	0	62,388
<b>TOTAL, CONSERVATION FACILITIES</b>	<b>105,297</b>	<b>0</b>	<b>0</b>	<b>0</b>	<b>1,081,861</b>	<b>0</b>	<b>1,187,158</b>	<b>134,963</b>	<b>1,322,121</b>
<b>TRANSPORTATION FACILITIES</b>									
Upper Feather Division									
Grizzly Valley Pipeline	(1)	0	275	0	0	347	621	61	682
North Bay Aqueduct	358,785	0	676	0	0	108,791	468,252	0	468,252
South Bay Aqueduct	146,022	0	1,749	0	0	117,873	265,644	23,431	289,075
California Aqueduct									
North San Joaquin Division	6,008	0	161	0	0	192,002	198,171	5,776	203,947
San Luis Division	9,186	0	0	0	0	135,337	144,523	8,030	152,553
South San Joaquin Division	(2,591)	0	3,885	2,093	0	299,316	302,703	17,833	320,536
Tehachapi Division	(5,230)	0	0	5,230	0	343,403	343,403	20,717	364,120
Mojave Division	(41,107)	0	841	0	0	330,374	290,108	40,266	330,374
Santa Ana Division	49,274	0	6,010	5,331	0	451,162	511,777	45,432	557,209
West Branch	465	0	476	37	0	510,591	511,569	33,764	545,333
Coastal Branch	(176)	0	176	0	0	504,638	504,638	0	504,638
<b>Total, California Aqueduct</b>	<b>15,829</b>	<b>0</b>	<b>11,549</b>	<b>12,691</b>	<b>0</b>	<b>2,766,823</b>	<b>2,806,892</b>	<b>171,818</b>	<b>2,978,710</b>
<b>TOTAL, TRANSPORTATION FACILITIES</b>	<b>520,635</b>	<b>0</b>	<b>14,249</b>	<b>12,691</b>	<b>0</b>	<b>2,993,834</b>	<b>3,541,409</b>	<b>195,310</b>	<b>3,736,719</b>
East Branch Enlargement	0	0	0	0	0	853,239	853,239	0	853,239
East Branch Extention	0	0	0	0	0	375,669	375,669	0	375,669
Coastal Power Allocation	0	0	0	0	0	30,708	30,708	0	30,708
Agricultural Drainage Facilities	0	0	0	0	0	0	0	99,382	99,382
Off-Aqueduct Power Generation Facilities	0	0	0	0	0	517,466	517,466	0	517,466
Small Hydro Power Generation Facilities	0	0	0	0	14,095	83,594	97,689	0	97,689
Land Purchase - Kern Water Bank	0	0	0	0	34,686	0	34,686	0	34,686
Unassigned / Miscellaneous	0	0	0	0	0	0	0	105,405	105,405
Davis-Grunsky	0	0	0	0	0	0	0	130,000	130,000
<b>TOTAL THROUGH 2015</b>	<b>625,932</b>	<b>0</b>	<b>14,249</b>	<b>12,691</b>	<b>1,130,642</b>	<b>4,854,510</b>	<b>6,638,024</b>	<b>665,060</b>	<b>7,303,084</b>

a) Miscellaneous project receipts that are applied for accounting purposes to reduce the capital costs of the particular facilities.

b) These allowances are included for planning the future financial program, but not for determining current water charges.

c) See Table B-8.

d) See Table B-9.

e) See Table B-13.

f) See Table B-10 (Published Appendix B 132-08 ,blue binder). Mojave Division total reduced by \$83,488,000 for costs included in "Small Hydro Power Generation Facilities" line.

**TABLE B-8. SWP Capital Costs of Requested Delivery Structures**

(in dollars)

Project Service Area and Water Supply Contractor	Calendar Year Capital Costs (a)						
	1952-2005	2006	2007	2008	2009	2010	Total
	[1]	[2]	[3]	[4]	[5]	[6]	[7]
<b>FEATHER RIVER AREA</b>							
County of Butte	136,546	0	27,326	31,301	26,000	0	221,173
Plumas County Flood Control and Water Conservation District	645	3,046	2,808	3,295	0	0	9,794
Thermalito Irrigation District (b)	43,939	0	0	0	0	0	43,939
<b>Subtotal</b>	<b>181,130</b>	<b>3,046</b>	<b>30,134</b>	<b>34,596</b>	<b>26,000</b>	<b>0</b>	<b>274,906</b>
<b>NORTH BAY AREA</b>							
Napa County Flood Control and Water Conservation District	13,590	0	0	0	0	0	13,590
Solano County Water Agency	662,113	0	0	0	0	0	662,113
<b>Subtotal</b>	<b>675,703</b>	<b>0</b>	<b>0</b>	<b>0</b>	<b>0</b>	<b>0</b>	<b>675,703</b>
<b>SOUTH BAY AREA</b>							
Alameda County Flood Control and Water Conservation District, Zone 7	395,680	7,446	12,357	5,710	0	0	421,193
Alameda County Water District	239,579	0	0	0	0	0	239,579
Santa Clara Valley Water District	21,500	0	0	0	0	0	21,500
San Francisco Water Department (b)	1,066,680	0	0	0	0	0	1,066,680
<b>Subtotal</b>	<b>1,723,439</b>	<b>7,446</b>	<b>12,357</b>	<b>5,710</b>	<b>0</b>	<b>0</b>	<b>1,748,952</b>
<b>CENTRAL COASTAL AREA</b>							
San Luis Obispo County Flood Control and Water Conservation District	26,204	0	0	0	0	0	26,204
Santa Barbara County Flood Control and Water Conservation District	67,058	0	0	0	0	0	67,058
<b>Subtotal</b>	<b>93,262</b>	<b>0</b>	<b>0</b>	<b>0</b>	<b>0</b>	<b>0</b>	<b>93,262</b>
<b>SAN JOAQUIN VALLEY AREA</b>							
Castaic Lake Water Agency	82,567	0	0	0	0	0	82,567
Dudley Ridge Water District	304,541	0	0	0	0	0	304,541
Empire West Side Irrigation District	6,358	0	0	0	0	0	6,358
Green Valley Water District (c)	5,292	0	0	15,000	0	0	20,292
Kern County Water Agency	3,059,982	39,766	53,251	68,747	75,000	0	3,296,746
Oak Flat Water District	46,882	3,390	52,113	28,580	20,000	0	150,965
Tracy Golf and Country Club (c)	6,932	0	0	0	0	0	6,932
Tulare Lake Basin Water Storage District	277,483	0	0	0	0	0	277,483
Veterans Administration Cemetery (b)	3,342	0	0	0	0	0	3,342
<b>Subtotal</b>	<b>3,793,379</b>	<b>43,156</b>	<b>105,364</b>	<b>112,327</b>	<b>95,000</b>	<b>0</b>	<b>4,149,226</b>
<b>SOUTHERN CALIFORNIA AREA</b>							
Antelope Valley-East Kern Water Agency	418,914	15,522	25,385	23,345	25,000	0	508,166
Castaic Lake Water Agency	375,093	500	0	0	0	0	375,593
Coachella Valley Water District	14,206	0	0	0	0	0	14,206
Crestline-Lake Arrowhead Water Agency	25,298	0	0	0	0	0	25,298
Desert Water Agency	23,438	0	0	0	0	0	23,438
Littlerock Creek Irrigation District	23,732	0	0	0	0	0	23,732
Mojave Water Agency	211,765	0	0	0	0	0	211,765
Palmdale Water District	34,173	0	0	0	0	0	34,173
San Bernardino Valley Municipal Water District	960,685	0	0	0	0	0	960,685
San Gabriel Valley Municipal Water District	131,052	0	0	0	0	0	131,052
San Geronio Pass Water Agency	66,530	8,139	14,412	9,969	5,000	0	104,050
The Metropolitan Water District of Southern California	4,814,078	0	0	0	0	0	4,814,078
Ventura County Watershed Protection District	79,699	0	0	0	0	0	79,699
<b>Subtotal</b>	<b>7,178,663</b>	<b>24,161</b>	<b>39,797</b>	<b>33,314</b>	<b>30,000</b>	<b>0</b>	<b>7,305,935</b>
<b>TOTAL</b>	<b>13,645,576</b>	<b>77,809</b>	<b>187,652</b>	<b>185,947</b>	<b>151,000</b>	<b>0</b>	<b>14,247,984</b>

- a) Approximate only, not to be construed as invoice amounts.
- b) Not a SWP water supply contractor.
- c) Not a SWP water supply contractor, but has contracted for water.

**TABLE B-9. Capital Costs of Requested Excess Peaking Capacity**

(in dollars unless otherwise indicated)

Sheet 1 of 2

Calendar Year	Total Advance Payments and Credits for Excess Capacity [1]	Total Incremental Costs for Excess Capacity [2]	Over payment (+) or Under payment (-) (a) [3]	Annual Surplus Money Investment Fund Interest Rate (b) [4]		Net Over or Underpayment With Interest (c) [6]
				Jan-Jun	Jul-Dec	
<b>THE METROPOLITAN WATER DISTRICT OF SOUTHERN CALIFORNIA</b>						
1965	0	158,000	(158,000)	3.968%	4.184%	(163,412)
1966	8,056,000	435,800	7,620,200	4.540%	5.057%	7,701,103
1967	9,094,963	1,878,270	7,216,693	4.815%	4.744%	15,524,533
1968	1,523,252	2,887,351	(1,364,099)	5.330%	5.540%	14,959,187
1969	8,310,651	3,059,310	5,251,341	5.946%	6.389%	21,369,973
1970	3,426,736	2,397,102	1,029,634	7.071%	7.125%	23,986,083
1971	1,086,045	1,146,648	(60,603)	5.154%	5.580%	25,238,017
1972	(4,244,807)	487,394	(4,732,201)	4.477%	4.977%	21,532,965
1973	(15,913,829)	25,041	(15,938,870)	6.023%	8.717%	6,014,116
1974	0	37,775	(37,775)	9.222%	10.351%	6,576,393
1975	0	2,085	(2,085)	7.089%	6.791%	7,038,515
1976	0	0	0	6.048%	6.021%	7,469,662
1977	0	0	0	5.788%	6.182%	7,923,403
1978	0	0	0	7.171%	8.096%	8,539,736
1979	0	0	0	8.979%	9.671%	9,354,605
1980	0	0	0	11.500%	11.500%	10,461,314
Total	11,339,011	12,514,776	(1,175,765)	-	-	10,461,314
<b>SAN GABRIEL VALLEY MUNICIPAL WATER DISTRICT</b>						
1967	0	25,730	(25,730)	4.815%	4.744%	(26,611)
1968	184,422	44,053	140,369	5.330%	5.540%	117,587
1969	49,052	38,075	10,977	5.946%	6.389%	136,751
1970	44,911	17,959	26,952	7.071%	7.125%	175,186
1971	61,588	5,900	55,688	5.154%	5.580%	242,927
1972	(20,263)	6,835	(27,098)	4.477%	4.977%	226,230
1973	(180,465)	0	(180,465)	6.023%	8.717%	49,198
1974	0	0	0	9.222%	10.351%	54,130
1975	0	0	0	7.089%	6.791%	57,952
1976	0	0	0	6.048%	6.021%	61,501
1977	0	0	0	5.788%	6.182%	65,237
1978	0	0	0	7.171%	8.096%	70,312
1979	0	0	0	8.979%	9.671%	77,021
1980	0	0	0	11.500%	11.500%	86,133
Total	139,245	138,552	693	-	-	86,133
<b>ANTELOPE VALLEY-EAST KERN WATER AGENCY</b>						
1968	85,495	1,645	83,850	5.330%	5.540%	86,962
1969	52,625	6,326	46,299	5.946%	6.389%	140,964
1970	101,648	15,076	86,572	7.071%	7.125%	243,222
1971	34,062	11,748	22,314	5.154%	5.580%	279,673
1972	(12,794)	2,018	(14,812)	4.477%	4.977%	277,552
1973	(205,354)	308	(205,662)	6.023%	8.717%	77,288
1974	0	96	(96)	9.222%	10.351%	84,933
1975	0	0	0	7.089%	6.791%	90,929
1976	0	190	(190)	6.048%	6.021%	96,300
1977	0	0	0	5.788%	6.182%	102,150
1978	0	0	0	7.171%	8.096%	110,096
1979	0	0	0	8.979%	9.671%	120,601
1980	0	0	0	11.500%	11.500%	134,869
Total	55,682	37,407	18,275	-	-	134,869

- a) Overpayment or underpayment for each calendar year - column (1) minus column (2).
- b) Interest rates shown are annual rates. Interest is credited daily at applicable rates on funds deposited in the State's Surplus Money Investment Fund.
- c) Amounts shown are end-of-year balances. Interest on overpayments is credited at applicable Surplus Money Investment Fund Interest Rates Shown in columns (4) and (5). Interest on underpayments is charged at the 1980 Project Interest Rate of 4.584 percent

**TABLE B-9. Capital Costs of Requested Excess Peaking Capacity**

(in dollars)

Sheet 2 of 2

Reach Number	ANNUAL REQUIRED ADVANCE OF FUNDS													Reach Total
	Incremental Costs and Advance Payments by Calendar Year													
	1965	1966	1967	1968	1969	1970	1971	1972	1973	1974	1975	1976	1981	
	[7]	[8]	[9]	[10]	[11]	[12]	[13]	[14]	[15]	[16]	[17]	[18]	[19]	[20]
<b>THE METROPOLITAN WATER DISTRICT OF SOUTHERN CALIFORNIA</b>														
<i>Incremental Costs</i>														
8C		1,000	1,000											2,000
8D		43,500	43,500											87,000
9		27,000	27,000	13,500										67,500
10A		29,700	29,700	14,800										74,200
11B	10,100	18,300	18,300	9,200										55,900
12D	1,800		19,300	25,800	12,900									59,800
12E	1,800		12,400	18,800	10,800									43,800
13B			12,600	37,800	31,600									82,000
14A	2,500	500	11,100	80,216	107,504	124,069	37,519	6,413	381	87				370,289
14B	1,200	1,800		19,100	19,100	12,800								54,000
14C	1,800	900		13,500	13,500	9,000								38,700
15A	700		14,000	66,947	133,357	128,099	54,821	5,327	946	2,076				406,273
16A	700		18,900	137,894	182,000	211,608	133,927	26,203	5,767	6,156				723,155
17E		51,500	444,600	537,247	860,024	998,985	699,281	193,286	17,947	29,456	2,085			3,834,411
17F	109,100	261,600	261,600	261,600	261,600	239,500								1,395,000
25			964,270	1,650,947	1,426,925	673,041	221,100	256,165						5,192,448
28J		304,612	13,706	296,668	65,966	230,169	1,209,586	2,017,134	235,900	4,900				4,378,641
Total	129,700	740,412	1,891,976	3,184,019	3,125,276	2,627,271	2,356,234	2,504,528	260,941	42,675	2,085			16,865,117
<i>Current Adjustment</i>														
8C through 25	1. Advance Payments Applied to Incremental Costs Amendment 2 (d)													
	0	8,056,000	9,094,963	1,523,252	8,310,651	3,426,736	1,086,045	(4,244,807)	(14,381,396)				(356,668)	12,514,776
28J	2. Interest Credits-Amendment 2 (e)													
									(1,532,433)				(10,104,646)	(11,637,079)
	3. Advance Payments Applied to Incremental Costs Amendment 5 (f)													
	0	1,240,000	1,483,180	2,469,325	(927,035)	1,729,160	3,215,258	2,967,475	1,690,000	(9,488,722)				4,378,641
	4. Interest Credits-Amendment 5 (g)													
										(2,721,803)				(2,721,803)
	5. Net Required Advance of Funds													
	0	9,296,000	10,578,143	3,992,577	7,383,616	5,155,896	4,301,303	(1,277,332)	(14,233,829)	(12,210,525)			(10,461,314)	2,524,535
<b>SAN GABRIEL VALLEY MUNICIPAL WATER DISTRICT</b>														
<i>Incremental Costs</i>														
25			25,730	44,053	38,075	17,959	5,900	6,835						138,552
			25,730	44,053	38,075	17,959	5,900	6,835						138,552
<i>Current Adjustments</i>														
	1. Advance Payments Applied to Incremental Costs (d)													
			0	184,422	49,052	44,911	61,588	(20,263)	(174,133)				(7,025)	138,552
	2. Interest Credit													
									(6,332)				(79,108)	(85,440)
	3. Net Required Advance of Funds													
			0	184,422	49,052	44,911	61,588	(20,263)	(180,465)				(h) (86,133)	53,112
<b>ANTELOPE VALLEY-EAST KERN WATER AGENCY</b>														
<i>Incremental Costs</i>														
29A				1,645	6,326	13,376	10,048	2,018	308	96		190		34,007
29F						1,700	1,700							3,400
				1,645	6,326	15,076	11,748	2,018	308	96		190		37,407
<i>Current Adjustment</i>														
	1. Advance Payments Applied to Incremental Costs (d)													
				85,495	52,625	101,648	34,062	(12,794)	(189,120)	0		0	(34,509)	37,407
	2. Interest Credit													
									(16,234)				(100,360)	(116,594)
	3. Net Required Advance of Funds													
				85,495	52,625	101,648	34,062	(12,794)	(205,354)	0		0	(h) (134,869)	(79,187)

d) Actual payments are shown for 1965 through 1976 with 1981 adjusted to reflect overpayments and underpayments without interest for prior years.

e) Interest for overpayments and underpayments under provisions of Amendment 2 of the contract.

f) Actual payments are shown for 1965 through 1973 with 1974 adjusted to reflect overpayments and underpayments without interest for prior years.

g) Interest for overpayments and underpayments under provisions of Amendment 5 of the contract.

h) Amounts in excess of incremental costs, under the provisions of the contract, reduce the Transportation Charge capital cost component of the Agency's Statement of Charges for January 1981.

**TABLE B-10. Capital Costs of Each Aqueduct Reach to Be Reimbursed through Capital Cost Component of Transportation Charge**

(in dollars)

Sheet 1 of 8

Calendar Year	UPPER FEATHER DIVISION	NORTH BAY AQUEDUCT					SOUTH BAY AQUEDUCT			
		Reach 1	Reach 2	Reach 3A	Reach 3B	Total	Reach 1	Reach 2	Reach 4	Reach 5
	[1]	[2]	[3]	[4]	[5]	[6]	[7]	[8]	[9]	[10]
1952	0	0	0	0	0	0	97	34	30	57
1953	0	0	0	0	0	0	477	166	144	297
1954	0	0	0	0	0	0	1,466	508	437	959
1955	0	0	0	0	0	0	1,944	674	560	1,266
1956	0	0	0	0	0	0	18,789	6,515	5,090	12,545
1957	0	13,290	3,391	0	9,953	26,634	45,090	15,639	12,285	33,218
1958	2	19,202	5,011	0	25,798	50,011	195,985	80,961	7,714	21,930
1959	14	7,517	2,118	0	17,653	27,288	496,140	148,516	24,945	17,118
1960	28	8,797	4,292	0	4,838	17,927	1,130,378	67,351	71,779	68,028
1961	10	1,551	10,318	0	2,526	14,395	3,273,247	180,596	307,885	74,398
1962	32	217	(1,751)	0	414	(1,120)	1,548,884	203,535	695,446	35,102
1963	51	2,510	(1,063)	0	983	2,430	480,716	69,182	2,284,291	206,587
1964	7,791	39,879	12,046	0	21,934	73,859	2,549,118	15,903	181,900	264,410
1965	3,139	72,793	17,900	0	170,361	261,054	807,505	153,454	85,425	447,830
1966	(48)	59,615	12,972	0	438,949	511,536	898,074	149,529	142,096	1,690,200
1967	47	47,257	11,597	0	1,551,023	1,609,877	607,614	50,423	293,304	3,496,284
1968	51,573	70,586	19,560	0	831,158	921,304	965,119	19,543	89,300	2,931,101
1969	234,232	63,650	23,628	0	46,428	133,706	455,173	9,618	3,860	896,727
1970	16,227	59,090	42,733	0	9,415	111,238	52,481	3,380	10,517	154,358
1971	27,204	20,819	31,516	0	8,480	60,815	24,505	4,645	5,035	20,395
1972	9	15,538	12,952	0	10,058	38,548	26,918	825	2,945	26,090
1973	25	18,488	29,018	0	39,878	87,384	24,468	4,010	6,016	12,708
1974	45	67,352	29,978	0	134,332	231,662	17,108	1,192	1,765	65,587
1975	21	62,855	73,112	0	45,091	181,058	57,619	561	1,165	7,291
1976	51	52,419	75,611	218	13,168	141,416	104,242	2,846	8,915	12,701
1977	28	53,274	65,662	2,240	23,138	144,314	176,062	3,625	3,225	16,158
1978	38	61,936	57,158	2,955	28,987	151,036	264,581	4,494	3,668	14,028
1979	23	316,620	91,367	3,953	62,240	474,180	111,106	17,151	8,515	31,725
1980	26	422,804	111,600	19,910	96,125	650,439	368,942	17,708	8,249	38,045
1981	34	430,992	147,295	(10,752)	43,157	610,692	(145,428)	3,600	6,533	12,448
1982	11	934,812	357,720	(7,165)	134,408	1,419,775	(44,778)	18,971	7,451	37,824
1983	19	1,091,091	1,076,627	2,628	517,615	2,687,961	429,225	73,925	38,185	72,415
1984	26	1,875,968	2,317,661	3,290	1,068,363	5,265,282	506,951	36,354	9,610	92,846
1985	29	2,248,491	7,849,886	27,815	3,416,370	13,542,562	34,103	2,822	5,034	27,138
1986	31	16,420,238	10,020,277	1,309,599	1,819,349	29,569,463	85,732	14,715	17,144	13,982
1987	32	11,873,826	7,214,307	1,628,932	1,670,596	22,387,661	126,377	15,693	27,881	32,931
1988	55	3,287,756	1,648,431	1,015,971	686,821	6,638,979	290,505	36,744	51,786	25,078
1989	44	1,056,583	950,985	224,567	374,886	2,607,021	130,609	16,848	35,518	12,582
1990	63	493,522	537,881	145,694	71,938	1,249,035	275,732	32,387	99,251	40,263
1991	54	76,599	17,130	24,846	70,542	189,117	1,153,109	26,900	53,613	21,889
1992	42	56,492	6,525	18,333	37,778	119,128	401,906	53,036	61,799	51,386
1993	30	104,317	24,579	40,129	82,032	251,057	313,476	55,679	79,149	39,293
1994	14	68,065	13,463	27,107	45,909	154,544	(211,712)	29,017	362,585	36,350
1995	3	26,002	5,920	7,337	20,617	59,876	265,751	42,516	48,189	21,436
1996	0	14,790	3,334	6,614	14,606	39,344	139,573	13,049	25,751	10,677
1997	3	67,264	35,545	38,585	(13,571)	127,823	203,476	31,135	36,986	16,906
1998	7	15,410	6,392	6,797	10,396	38,995	67,974	6,120	14,731	4,616
1999	2	71,950	35,515	33,879	32,613	173,957	162,161	25,329	35,716	24,347
2000	24	29,992	8,327	11,711	4,156	54,186	100,654	15,688	24,144	19,652
2001	20	10,597	3,904	3,892	1,954	20,347	436,756	4,272	118,836	4,207
2002	14	27,018	18,971	15,254	4,614	65,857	3,068,535	5,648	329,244	64,425
2003	0	14,733	9,242	4,658	46,313	74,946	4,465,566	200,125	199,457	360,387
2004	0	24,222	2,418	2,387	145,422	174,449	1,257,762	861,149	472,174	99,594
2005	0	89,100	4	9	33,810	122,923	1,224,166	859,794	702,448	(100)
2006	5	31,833	343	145	879,143	911,464	2,850,446	628,947	1,080,136	637
2007	0	69,114	114	35	3,220,978	3,290,241	3,091,281	602,713	1,687,283	2,056
2008	0	662,783	153,128	12,992	5,252,545	6,081,448	10,926,228	155,714	1,712,717	33,434
2009	0	1,048,590	166,514	11,538	1,643,747	2,870,389	3,853,046	263,194	2,937,766	40,796
2010	0	703,815	141,506	0	345,393	1,190,714	959,006	83,568	1,441,763	23,149
2011	0	157,278	124,042	0	79,827	361,147	187,313	11,624	35,174	11,177
2012	0	156,300	123,271	0	79,331	358,902	186,149	11,552	34,955	11,107
2013	0	70,148	55,324	0	35,604	161,076	83,544	5,184	15,688	4,985
2014	0	0	0	0	0	0	0	0	0	0
2015	0	0	0	0	0	0	0	0	0	0
<b>TOTAL</b>	<b>341,130</b>	<b>44,867,750</b>	<b>33,817,307</b>	<b>4,636,103</b>	<b>25,470,192</b>	<b>108,791,352</b>	<b>51,579,042</b>	<b>5,476,596</b>	<b>16,075,203</b>	<b>11,867,056</b>

**TABLE B-10. Capital Costs of Each Aqueduct Reach to Be Reimbursed through Capital Cost Component of Transportation Charge**

(in dollars)

Sheet 2 of 8

Calendar Year	SOUTH BAY AQUEDUCT (continued)					CALIFORNIA AQUEDUCT NORTH SAN JOAQUIN DIVISION			
	Reach 6	Reach 7	Reach 8	Reach 9	Total	Reach 1	Reach 2A	Reach 2B	Subtotal
	[11]	[12]	[13]	[14]	[15]	[16]	[17]	[18]	[19]
1952	8	66	72	132	496	4,012	3,279	1,499	8,790
1953	38	327	336	640	2,425	10,559	8,589	3,964	23,112
1954	123	1,005	1,003	1,954	7,455	13,796	11,163	5,179	30,138
1955	160	1,293	1,149	2,454	9,500	7,370	5,952	2,760	16,082
1956	1,559	11,959	11,043	28,372	95,872	9,880	5,020	2,398	17,298
1957	3,659	28,675	27,385	563,114	729,065	11,953	5,456	2,612	20,021
1958	2,243	17,872	17,385	560,904	904,994	18,585	17,191	7,994	43,770
1959	357	3,200	3,568	149,874	843,718	123,170	100,306	45,510	268,986
1960	1,102	2,944	4,498	359,749	1,705,829	191,408	102,136	48,968	342,512
1961	4,726	18,325	22,765	(1,367)	3,880,575	153,765	195,947	42,843	392,555
1962	17,295	160,939	178,242	209,042	3,048,485	612,258	491,225	168,218	1,271,701
1963	265,414	1,250,386	939,832	129,902	5,626,310	1,993,284	1,525,734	684,095	4,203,113
1964	100,603	1,716,371	2,327,770	2,947,522	10,103,597	4,674,280	2,369,858	700,074	7,744,212
1965	42,345	368,476	637,266	1,921,844	4,464,145	5,877,189	6,873,699	2,975,719	15,726,607
1966	17,663	34,915	140,350	777,887	3,850,714	8,553,362	14,112,820	5,677,099	28,343,281
1967	(41,567)	137,856	147,183	379,764	5,070,861	9,678,607	10,672,113	6,646,739	26,997,459
1968	84,553	2,130	68,057	253,152	4,412,955	6,392,664	891,681	1,303,186	8,587,531
1969	4,279	11,572	162,300	32,000	1,575,529	3,542,767	792,259	443,924	4,778,950
1970	2,487	6,820	20,086	(15,718)	234,411	2,236,607	149,692	115,578	2,501,877
1971	4,350	6,923	17,750	39,084	122,687	98,138	215,512	69,410	383,060
1972	1,084	203	4,800	32,199	95,064	159,608	43,721	7,744	211,073
1973	288	989	7,449	9,693	65,621	105,581	25,496	22,418	153,495
1974	527	6,020	30,628	11,433	134,260	177,700	16,627	45,707	240,034
1975	126	679	1,086	3,464	71,991	239,144	14,680	169,676	423,500
1976	701	3,529	8,362	26,186	167,482	641,860	45,533	65,943	753,336
1977	270	1,310	8,651	24,938	234,239	274,381	20,283	22,568	317,232
1978	231	1,204	1,631	17,123	306,960	801,265	36,221	9,714	847,200
1979	1,367	1,721	2,134	7,322	181,041	1,051,792	59,695	26,106	1,137,593
1980	1,321	1,718	2,182	7,102	445,267	4,173,603	96,760	38,789	4,309,152
1981	308	1,462	1,398	5,077	(114,602)	(502,921)	1,487,516	38,451	1,023,046
1982	716	1,561	1,746	6,074	29,565	700,738	46,501	22,308	769,547
1983	407	5,721	8,143	23,367	651,388	706,104	84,435	211,619	1,002,158
1984	269	1,853	1,667	13,301	662,851	1,559,539	41,352	48,478	1,649,369
1985	402	1,657	2,129	6,750	80,035	677,955	24,812	19,404	722,171
1986	1,119	2,744	3,313	12,234	150,983	398,788	63,830	35,420	498,038
1987	1,496	3,081	3,560	21,842	232,861	799,672	88,945	41,659	930,276
1988	5,706	6,689	7,603	33,728	457,839	2,898,156	(128,051)	(56,448)	2,713,657
1989	2,641	3,878	4,755	14,489	221,320	6,898,872	346,589	173,993	7,419,454
1990	5,092	19,899	36,584	87,796	597,004	13,483,785	112,002	2,446,232	16,042,019
1991	1,942	5,059	7,357	31,682	1,301,551	13,914,632	133,121	114,981	14,162,734
1992	1,184	2,042	35,464	609,067	6,260,482	6,260,482	241,456	239,437	6,741,375
1993	3,618	6,028	8,873	42,200	548,316	2,542,869	257,330	200,072	3,000,271
1994	2,897	4,781	5,346	89,991	319,255	1,145,666	148,396	88,357	1,382,419
1995	11,556	3,635	14,769	24,750	432,602	1,462,211	217,940	131,995	1,812,146
1996	3,092	2,271	2,699	12,522	209,634	874,227	74,153	41,215	989,595
1997	1,454	4,141	3,655	20,589	318,342	2,064,446	146,851	84,303	2,295,600
1998	363	1,134	(6,005)	5,776	94,709	729,475	33,695	16,670	779,840
1999	1,533	3,304	12,727	31,634	296,751	2,208,776	88,951	90,639	2,388,366
2000	2,406	4,944	5,331	10,755	183,574	(706,517)	57,503	40,185	(608,829)
2001	91,721	68,849	404,226	1,190,653	2,319,520	371,407	91,792	8,926	472,125
2002	229,409	453,259	1,107,580	2,977,939	8,236,039	388,781	44,543	22,639	455,963
2003	67,216	509,964	477,926	1,409,227	7,689,868	178,153	22,778	13,565	214,496
2004	3,209	3,141	39,380	3,277,033	6,013,442	893,916	15,663	77,867	987,446
2005	5,334	5,239	4,803	731,389	3,533,073	293,412	39,870	98,327	431,609
2006	1,360	1,413	1,454	15,695	4,580,088	349,779	16,400	178,571	544,750
2007	7,616	7,605	7,674	11,338	5,417,566	375,074	60,885	123,124	559,083
2008	43,019	60,134	68,180	140,393	13,139,819	1,788,098	408,921	1,138,362	3,335,381
2009	72,241	91,099	100,117	190,084	7,548,343	2,351,299	577,984	1,992,109	4,921,392
2010	45,371	62,331	71,014	141,744	2,827,946	1,186,095	396,495	1,061,590	2,644,180
2011	3,600	18,466	26,078	72,298	365,730	408,989	154,688	103,788	667,465
2012	3,577	18,351	25,916	71,849	363,456	406,447	153,727	103,143	663,317
2013	1,606	8,236	11,631	32,246	163,120	182,413	68,993	46,291	297,697
2014	0	0	0	0	0	0	0	0	0
2015	0	0	0	0	0	0	0	0	0
<b>TOTAL</b>	<b>1,140,792</b>	<b>5,193,398</b>	<b>7,268,842</b>	<b>19,271,674</b>	<b>117,872,603</b>	<b>119,119,406</b>	<b>44,528,714</b>	<b>28,353,706</b>	<b>192,001,826</b>

**TABLE B-10. Capital Costs of Each Aqueduct Reach to Be Reimbursed through Capital Cost Component of Transportation Charge**

(in dollars)

Sheet 3 of 8

Calendar Year	CALIFORNIA AQUEDUCT (continued)								
	SAN LUIS DIVISION						SOUTH SAN JOAQUIN DIVISION		
	Reach 3	Reach 4	Reach 5	Reach 6	Reach 7	Subtotal	Reach 8C	Reach 8D	Reach 9
[20]	[21]	[22]	[23]	[24]	[25]	[26]	[27]	[28]	
1952	2,492	3,549	3,987	1,010	1,390	12,428	13	727	1,109
1953	6,999	10,144	10,986	2,834	3,869	34,832	45	2,671	4,185
1954	8,704	12,545	13,693	3,520	4,766	43,228	50	2,719	4,026
1955	4,273	6,055	6,813	1,728	2,325	21,194	19	888	1,100
1956	3,295	5,600	5,857	1,445	3,556	19,753	98	3,850	4,376
1957	3,543	6,115	6,357	1,565	3,998	21,578	234	10,604	13,209
1958	11,927	19,393	22,037	5,509	7,512	66,378	375	19,033	25,073
1959	21,979	37,358	39,689	9,813	19,679	128,518	436	20,578	25,697
1960	207,025	45,419	41,044	12,074	37,633	343,195	1,673	44,565	25,290
1961	184,443	292,639	170,559	38,338	70,068	756,047	3,949	75,726	30,852
1962	495,836	549,984	252,698	22,397	26,967	1,347,882	6,131	159,481	62,375
1963	2,772,189	2,034,351	2,498,712	66,353	30,647	7,402,252	5,861	161,252	81,343
1964	4,348,311	4,932,301	1,053,227	161,422	251,461	10,746,722	4,014	90,622	117,907
1965	3,860,997	5,688,252	2,869,931	1,072,111	667,768	14,159,059	15,049	491,042	564,036
1966	2,312,372	8,527,843	5,765,798	4,230,221	7,708,334	28,544,568	201,274	5,197,322	2,539,278
1967	(44,527)	2,062,305	6,942,522	222,885	6,675,398	15,858,583	212,285	4,982,844	3,363,650
1968	119,884	395,689	973,956	179,917	461,031	2,130,477	64,234	611,192	940,074
1969	(6,065)	126,946	98,492	107,486	160,668	487,527	58,960	116,146	85,130
1970	32,387	(20,243)	105,385	(827,457)	1,215,966	506,038	23,011	106,810	84,116
1971	99,945	230,624	305,227	26,995	341,010	1,003,801	8,813	33,099	23,088
1972	15,990	90,852	17,053	14,621	281,343	419,859	10,818	13,349	16,603
1973	6,753	103,707	41,549	13,810	41,427	207,246	5,145	11,089	13,249
1974	6,618	117,165	55,978	16,199	71,796	267,756	5,434	24,433	16,567
1975	18,921	107,275	23,671	8,797	152,574	311,238	5,424	15,960	12,966
1976	17,485	79,554	13,041	5,138	41,687	156,905	19,931	76,280	62,164
1977	35,707	84,669	9,412	4,028	9,655	143,471	21,096	70,005	97,952
1978	8,539	428,395	7,006	3,536	6,994	454,470	7,584	40,453	17,395
1979	(35,394)	543,225	19,463	9,485	(242,253)	294,526	10,474	6,181	6,227
1980	66,622	3,450,695	191,307	75,209	185,384	3,969,217	2,158	17,492	17,706
1981	28,491	(2,244,127)	(44,017)	(15,456)	918,984	(1,356,125)	1,151	9,642	9,541
1982	100,629	(1,616,569)	20,184	10,359	3,525,738	2,040,341	2,469	8,283	6,956
1983	75,639	33,881	11,785	6,638	1,811,638	1,939,581	7,955	13,782	11,090
1984	31,748	87,083	26,712	12,754	3,053,662	3,211,959	26,489	9,959	6,268
1985	53,251	56,732	13,685	6,934	582,910	713,512	7,220	9,762	7,688
1986	73,979	201,509	50,668	19,223	1,282,469	1,627,848	8,902	25,011	20,503
1987	(7,829)	116,268	40,009	15,946	518,349	682,743	12,744	18,927	56,042
1988	(149,385)	224,154	(406,398)	(137,353)	923,622	454,640	9,833	(119,741)	(60,639)
1989	39,652	594,894	232,852	80,090	575,855	1,523,343	5,279	91,501	278,061
1990	39,270	259,895	79,589	29,606	461,219	869,579	5,814	41,345	2,016,434
1991	4,916,134	397,959	98,847	35,860	511,519	5,960,319	4,588	43,140	41,348
1992	(757,001)	545,729	211,854	74,544	396,398	471,524	3,546	103,695	109,225
1993	110,233	724,929	186,271	70,815	720,283	1,812,531	15,016	101,634	90,929
1994	1,151,976	288,018	63,862	27,812	710,770	2,242,438	6,770	42,455	40,696
1995	285,776	441,479	130,761	58,640	1,914,186	2,830,842	12,548	49,963	43,251
1996	31,942	(110,471)	34,529	12,219	588,712	556,931	6,444	29,863	27,050
1997	73,224	513,793	(277,781)	42,881	5,016,215	5,368,332	11,497	49,111	43,799
1998	19,692	304,115	34,319	16,542	2,819,556	3,194,224	2,562	11,115	8,955
1999	18,187	158,902	100,061	41,691	1,901,382	2,220,223	5,706	25,179	23,510
2000	101,618	373,699	78,036	36,186	1,139,073	1,728,612	3,922	23,591	29,281
2001	(10,513)	(47,112)	519,031	(3,546)	61,595	519,455	2,280	17,030	21,196
2002	12,237	24,434	6,079,343	3,454	(2,453,483)	3,665,985	3,627	44,010	20,221
2003	8,863	79,641	(5,372,496)	7,923	2,183,794	(3,092,275)	2,130	18,793	16,715
2004	(15,306)	(13,531)	(50,311)	(2,395)	(458,897)	(540,440)	22,528	6,090	3,964
2005	261	11,162	129,328	3,493	995,247	1,139,491	26,296	11,514	6,256
2006	1,421	33,596	(7,390)	1,978	(271,298)	(241,693)	6,331	3,827	2,362
2007	2	119,508	74,607	12,802	199,850	406,769	13,926	23,862	13,537
2008	130,458	267,689	221,439	66,459	271,334	957,379	3,547	130,678	86,957
2009	130,458	1,100,204	334,785	103,445	360,301	2,029,193	3,931	199,656	126,163
2010	0	997,040	241,383	72,953	287,238	1,598,614	3,621	142,805	93,882
2011	0	115,728	83,220	21,158	166,206	386,312	3,174	46,423	39,504
2012	0	115,008	82,702	21,026	165,173	383,909	3,155	46,135	39,259
2013	0	51,616	37,117	9,437	74,130	172,300	1,416	20,705	17,619
2014	0	0	0	0	0	0	0	0	0
2015	0	0	0	0	0	0	0	0	0
<b>TOTAL</b>	<b>21,082,357</b>	<b>34,179,261</b>	<b>24,624,036</b>	<b>6,255,107</b>	<b>49,196,383</b>	<b>135,337,144</b>	<b>951,005</b>	<b>13,706,158</b>	<b>11,554,366</b>



**TABLE B-10. Capital Costs of Each Aqueduct Reach to Be Reimbursed through Capital Cost Component of Transportation Charge**

(in dollars)

Sheet 4 of 8

Calendar Year	CALIFORNIA AQUEDUCT (continued)								
	SOUTH SAN JOAQUIN DIVISION (continued)								
	Reach 10A	Reach 11B	Reach 12D	Reach 12E	Reach 13B	Reach 14A	Reach 14B	Reach 14C	Reach 15A
[29]	[30]	[31]	[32]	[33]	[34]	[35]	[36]	[37]	
1952	695	1,279	1,980	995	1,663	794	212	212	1,911
1953	2,569	4,790	7,480	3,745	6,236	2,599	733	741	7,016
1954	2,821	4,855	7,565	3,792	6,319	2,880	810	817	7,073
1955	1,097	1,557	2,404	1,211	2,025	1,183	325	327	2,253
1956	4,428	6,223	9,233	4,737	8,054	7,026	1,638	1,584	9,939
1957	13,269	18,772	29,082	14,615	24,411	15,651	3,834	3,864	26,871
1958	25,086	48,191	78,564	39,087	61,715	33,726	12,330	11,813	49,499
1959	25,787	67,246	107,781	53,836	86,478	64,824	22,102	21,828	70,838
1960	47,492	66,317	77,936	39,867	63,517	84,363	23,260	22,305	73,305
1961	68,505	46,073	88,274	51,457	28,015	242,753	91,290	65,565	150,205
1962	57,705	56,056	69,189	44,851	49,179	208,180	61,489	47,608	133,653
1963	52,585	91,914	173,985	86,405	67,733	425,626	104,436	77,970	102,072
1964	124,014	333,621	291,013	174,469	86,271	1,093,795	684,005	485,033	571,173
1965	622,257	1,053,029	1,524,848	1,044,851	196,487	3,385,205	1,655,024	1,436,258	476,830
1966	2,800,056	3,709,779	673,429	466,228	418,141	4,916,319	974,862	724,354	1,829,852
1967	3,652,342	4,636,627	1,881,333	1,244,265	1,238,428	2,788,299	525,653	400,183	1,721,304
1968	1,025,969	1,323,302	4,726,074	3,145,775	8,343,706	10,210,266	1,330,361	1,405,117	7,522,015
1969	145,111	229,185	706,272	529,080	3,704,065	15,112,041	1,223,457	1,134,395	9,523,012
1970	74,366	85,151	70,725	72,798	320,797	11,031,255	987,213	738,955	8,836,897
1971	15,595	45,006	43,988	42,624	339,078	2,925,191	193,255	36,514	3,275,227
1972	19,736	32,657	43,939	24,748	81,937	1,388,348	101,784	20,165	1,003,380
1973	14,283	16,448	9,980	16,320	25,090	680,834	19,584	13,469	798,805
1974	22,111	14,951	19,555	32,240	29,582	524,504	30,735	16,333	778,696
1975	15,865	13,479	10,793	13,678	25,827	269,197	25,164	21,048	370,265
1976	76,202	54,217	37,464	59,842	105,332	507,519	59,753	42,776	434,574
1977	75,628	52,919	22,826	54,444	81,293	301,515	49,972	30,152	235,514
1978	48,754	16,469	(2,816)	27,331	43,126	348,674	(653)	1,500	297,817
1979	241	6,906	13,401	14,229	25,411	293,786	9,846	7,856	245,590
1980	18,165	18,813	15,608	27,498	34,190	1,676,267	29,169	23,023	1,719,775
1981	10,309	14,885	26,473	20,972	25,515	(1,076,221)	27,551	33,674	(1,142,721)
1982	8,237	6,608	7,680	8,346	16,339	(745,914)	9,886	29,393	(804,147)
1983	14,488	9,792	14,174	13,050	35,872	419,650	17,389	24,933	115,983
1984	7,533	27,613	87,907	49,271	22,732	54,590	75,453	63,060	63,537
1985	9,215	6,949	5,263	8,013	8,875	(49,408)	9,523	5,867	54,782
1986	22,335	16,664	16,014	25,031	20,483	140,642	25,960	13,913	154,089
1987	16,704	13,512	12,369	20,023	15,435	101,453	20,411	8,581	227,047
1988	(159,357)	(73,648)	(151,040)	(51,401)	(120,104)	161,077	(75,276)	(75,307)	144,369
1989	70,153	65,216	63,382	120,925	73,037	2,778,880	119,559	36,660	2,952,046
1990	34,841	29,230	27,269	49,082	34,048	715,031	44,187	14,537	440,017
1991	36,888	32,195	30,146	55,119	34,144	423,235	50,345	12,116	353,596
1992	103,321	99,765	98,178	192,455	97,638	991,603	185,311	9,210	387,615
1993	90,291	70,131	63,247	118,440	80,530	687,462	109,792	38,960	942,211
1994	65,737	29,221	26,997	50,234	35,154	400,534	44,481	17,426	324,942
1995	435,909	32,487	25,516	49,885	41,733	524,524	48,740	29,125	450,952
1996	253,433	19,489	15,020	30,202	29,333	403,125	26,945	16,405	253,622
1997	73,458	30,890	25,368	48,767	40,900	451,910	47,815	29,878	809,848
1998	14,618	7,107	5,773	10,697	9,676	288,667	10,799	6,819	119,562
1999	47,359	17,022	13,362	34,410	31,539	260,623	24,634	14,826	264,538
2000	43,459	21,186	32,480	40,180	25,119	168,825	15,243	11,006	151,512
2001	42,731	14,471	22,325	34,996	8,027	71,645	4,537	3,988	66,918
2002	87,805	19,626	7,157	78,600	47,505	276,160	22,632	34,980	164,596
2003	22,946	9,280	8,935	18,114	15,308	136,429	6,671	9,686	110,489
2004	5,594	3,375	4,258	7,098	5,927	53,324	5,667	1,542	51,186
2005	7,253	6,256	12,511	6,256	6,256	21,215	12,511	0	8,794
2006	2,310	1,938	3,573	2,039	5,636	6,561	3,538	3,441	7,762
2007	14,768	12,473	24,754	12,833	20,481	41,744	24,759	7,330	27,874
2008	90,986	92,588	130,038	76,028	106,832	407,760	121,642	28,589	246,610
2009	135,375	132,404	203,697	114,050	148,191	552,946	194,392	31,686	315,198
2010	98,808	99,632	142,964	82,723	114,176	433,624	134,391	29,192	258,967
2011	37,004	44,544	39,738	29,722	57,294	234,992	32,223	25,589	166,854
2012	36,774	44,268	39,491	29,537	56,938	233,532	32,023	25,430	165,817
2013	16,504	19,867	17,723	13,256	25,554	104,809	14,372	11,413	74,419
2014	0	0	0	0	0	0	0	0	0
2015	0	0	0	0	0	0	0	0	0
<b>TOTAL</b>	<b>10,850,523</b>	<b>13,032,868</b>	<b>11,844,647</b>	<b>8,733,971</b>	<b>16,680,229</b>	<b>68,217,649</b>	<b>9,669,749</b>	<b>7,345,713</b>	<b>48,204,245</b>

**TABLE B-10. Capital Costs of Each Aqueduct Reach to Be Reimbursed through Capital Cost Component of Transportation Charge**

(in dollars)

Sheet 5 of 8

Calendar Year	CALIFORNIA AQUEDUCT (continued)								
	SOUTH SAN JOAQUIN (contd.)		TEHACHAPI DIVISION			MOJAVE DIVISION			
	Reach 16A	Subtotal	Reach 17E	Reach 17F	Subtotal	Reach 18A	Reach 19	Reach 19C	Reach 20A
[38]	[39]	[40]	[41]	[42]	[43]	[44]	[45]	[46]	
1952	4,440	16,030	9,703	4,072	13,775	4,090	1,520	0	2,561
1953	16,513	59,323	31,337	13,284	44,621	12,610	4,685	0	7,246
1954	16,601	60,328	46,243	20,010	66,253	16,642	6,184	0	9,506
1955	5,223	19,612	25,880	11,362	37,242	5,612	2,086	0	2,529
1956	21,754	82,940	47,487	17,609	65,096	6,038	2,244	0	2,440
1957	62,657	237,073	119,673	49,130	168,803	22,348	8,304	0	9,035
1958	133,083	537,575	164,056	72,091	236,147	37,917	14,166	123	15,391
1959	205,748	773,179	151,389	57,883	209,272	38,620	23,450	1,102	23,605
1960	204,788	774,678	203,222	45,323	248,545	21,356	26,093	5,318	40,523
1961	206,305	1,148,969	387,819	85,558	473,377	35,664	32,281	2,262	34,918
1962	171,396	1,127,293	353,119	82,610	435,729	68,508	266,284	1,841	10,323
1963	481,941	1,913,123	1,191,633	124,757	1,316,390	37,379	435,881	4,137	39,706
1964	1,778,952	5,834,889	1,866,000	775,005	2,641,005	95,693	706,369	8,564	43,342
1965	1,268,176	13,733,092	2,574,824	2,284,869	4,859,693	121,060	716,092	9,156	108,519
1966	2,896,274	27,347,168	5,537,412	9,323,517	14,860,929	366,116	1,644,699	13,373	159,282
1967	3,442,021	30,089,234	26,239,390	12,398,708	38,638,098	1,312,022	903,880	24,103	645,078
1968	7,578,498	48,226,583	33,363,479	7,416,464	40,779,943	136,804	7,109,653	71,388	1,889,601
1969	13,136,056	45,702,910	40,368,425	6,883,206	47,251,631	213,805	2,465,641	7,423	5,939,151
1970	13,890,751	36,322,845	35,446,706	6,786,231	42,232,937	2,211,077	1,210,665	6,217	3,652,478
1971	7,903,937	14,885,415	20,141,395	6,835,303	26,976,698	1,496,843	284,738	6,994	1,074,759
1972	3,025,555	5,783,019	10,002,935	34,791	10,037,726	129,417	409,903	3,620	471,963
1973	1,472,313	3,096,609	3,090,140	36,207	3,126,347	23,931	75,638	2,539	88,416
1974	1,031,843	2,546,984	4,798,348	152,494	4,950,842	28,399	205,581	2,703	138,673
1975	489,545	1,289,211	2,144,178	411,404	2,555,582	44,774	70,652	5,066	68,157
1976	618,049	2,154,103	1,124,357	174,629	1,298,986	121,043	84,593	6,786	59,967
1977	580,209	1,673,525	655,047	31,512	686,559	261,400	133,767	7,521	117,878
1978	582,775	1,428,409	1,900,843	27,956	1,928,799	553,014	57,150	5,872	51,615
1979	542,554	1,182,702	2,099,385	61,381	2,160,766	626,615	339,536	10,831	37,085
1980	3,772,498	7,372,362	17,433,610	6,046	17,439,656	1,130,429	1,073,430	3,604	308,188
1981	(2,527,211)	(4,566,440)	(3,848,206)	6,908	(3,841,298)	1,218,824	845,702	4,498	48,625
1982	(1,850,736)	(3,296,600)	11,370,112	6,054	11,376,166	6,968,683	746,900	3,920	33,869
1983	166,232	864,390	8,862,914	8,269	8,871,183	10,909,386	64,660	2,596	40,793
1984	119,387	613,799	3,227,937	31,701	3,259,638	8,340,371	309,491	3,124	17,505
1985	82,117	165,866	1,926,289	10,460	1,936,749	5,264,156	227,986	3,885	68,422
1986	186,348	675,895	1,381,955	33,788	1,415,743	2,049,111	2,069,663	4,261	2,331,707
1987	194,936	718,184	671,183	13,807	684,990	1,347,722	(6,453)	4,684	562,540
1988	262,334	(308,900)	1,408,760	(49,734)	1,359,026	847,954	(104,961)	13,409	(159,892)
1989	5,955,356	12,610,055	504,715	64,660	569,375	376,980	207,150	50,953	31,173
1990	640,283	4,092,118	783,219	25,218	808,437	202,065	(402,573)	61,192	(637,062)
1991	774,129	1,890,989	691,578	33,405	724,983	273,021	22,218	81,545	(188,732)
1992	731,512	3,113,074	741,986	24,369	766,355	620,962	384,568	86,644	225,398
1993	857,038	3,265,681	1,223,402	35,370	1,258,772	1,131,166	248,287	72,746	110,869
1994	853,328	1,937,975	806,213	16,681	822,894	998,126	164,096	60,147	51,340
1995	628,941	2,373,574	1,538,497	19,443	1,557,940	390,433	157,481	45,990	92,925
1996	388,064	1,498,995	2,571,039	10,797	2,581,836	91,593	69,281	22,188	35,656
1997	481,458	2,144,699	1,009,249	18,265	1,027,514	135,402	92,607	13,590	65,433
1998	440,746	937,096	925,574	6,843	932,417	47,486	36,170	4,164	29,900
1999	361,516	1,124,224	662,144	12,166	674,310	113,232	49,150	5,329	171,935
2000	372,997	938,801	408,352	14,333	422,685	120,267	90,145	936	83,478
2001	167,694	477,838	266,815	10,891	277,706	65,580	186,973	2,223	343,775
2002	286,748	1,093,667	247,986	9,586	257,572	35,787	(139,334)	1,374	(111,675)
2003	159,972	535,468	189,013	12,339	201,352	84,433	(19,049)	0	(11,368)
2004	323,072	493,625	374,614	4,946	379,560	20,129	17,620	0	18,936
2005	43,428	168,546	2,263,047	6,256	2,269,303	26,711	18,767	0	25,023
2006	18,770	68,088	5,855,272	8,220	5,863,492	7,583	5,564	0	6,861
2007	99,095	337,436	3,829,739	24,803	3,854,542	50,507	37,011	0	48,705
2008	597,355	2,119,610	6,797,277	258,839	7,056,116	312,368	221,931	0	243,791
2009	868,843	3,026,532	8,251,496	316,667	8,568,163	423,047	335,331	0	389,345
2010	645,298	2,280,083	10,249,627	269,388	10,519,015	332,090	241,886	0	269,299
2011	268,601	1,025,662	908,782	193,350	1,102,132	180,717	83,660	0	64,899
2012	266,932	1,019,291	903,134	192,148	1,095,282	179,594	83,140	0	64,496
2013	119,799	457,456	405,326	86,236	491,562	80,602	37,313	0	28,946
2014	0	0	0	0	0	0	0	0	0
2015	0	0	0	0	0	0	0	0	0
<b>TOTAL</b>	<b>78,524,837</b>	<b>299,315,960</b>	<b>288,927,075</b>	<b>55,959,884</b>	<b>344,886,959</b>	<b>52,425,314</b>	<b>24,697,546</b>	<b>759,941</b>	<b>19,448,850</b>

**TABLE B-10. Capital Costs of Each Aqueduct Reach to Be Reimbursed through Capital Cost Component of Transportation Charge**

(in dollars)

Sheet 6 of 8

Calendar Year	CALIFORNIA AQUEDUCT (continued)									
	MOJAVE DIVISION (continued)							SANTA ANA DIVISION		
	Reach 20B	Reach 21	Reach 22A	Reach 22B	Reach 23	Reach 24	Subtotal	Reach 25	Reach 26A	
[47]	[48]	[49]	[50]	[51]	[52]	[53]	[54]	[55]		
1952	892	5,788	35	2,013	2,074	2,413	21,386	3,334	5,599	
1953	3,402	17,846	71	5,752	6,886	7,438	65,936	10,275	17,264	
1954	4,548	23,558	369	8,560	7,849	9,820	87,036	13,566	22,790	
1955	2,213	7,947	178	2,754	2,725	3,313	29,357	4,575	7,687	
1956	2,655	8,542	216	2,905	2,961	3,561	31,562	4,917	8,264	
1957	9,826	31,616	800	10,757	10,962	13,177	116,825	18,205	30,586	
1958	16,752	53,569	1,397	18,717	18,578	22,627	199,237	31,001	52,019	
1959	18,604	56,724	1,844	25,421	20,372	45,646	255,388	39,325	58,137	
1960	37,179	43,893	11,029	136,751	17,152	109,816	449,110	65,655	93,700	
1961	37,102	21,532	14,517	215,859	9,546	373,473	777,154	26,979	56,734	
1962	10,730	8,197	4,186	164,168	4,336	279,421	817,994	9,964	36,235	
1963	40,865	26,670	17,081	237,695	7,228	358,503	1,205,145	31,013	112,271	
1964	71,116	33,912	22,793	262,996	6,863	244,003	1,495,651	69,669	202,642	
1965	343,506	91,095	65,689	827,655	11,836	621,566	2,916,174	279,237	206,356	
1966	1,311,628	160,388	178,538	1,746,245	31,078	1,018,628	6,629,975	415,066	364,004	
1967	1,718,942	498,257	367,961	3,146,128	62,135	2,331,106	11,009,612	3,184,296	638,539	
1968	2,291,691	1,141,929	1,145,768	4,588,850	102,207	2,600,293	21,078,184	8,264,126	1,268,194	
1969	5,626,284	2,358,737	1,515,147	7,750,478	260,659	11,131,406	37,268,731	6,807,783	1,768,456	
1970	5,304,372	3,232,911	2,081,810	23,451,612	1,240,798	16,885,193	59,277,133	2,169,051	7,229,429	
1971	1,091,123	825,070	432,464	16,772,680	1,922,115	5,385,721	29,292,507	1,135,248	9,811,736	
1972	635,507	484,772	324,865	3,788,894	48,049	788,479	7,085,469	1,095,740	5,528,987	
1973	83,840	63,774	36,179	1,623,274	24,333	4,225,877	6,247,801	136,994	1,810,729	
1974	118,639	103,545	54,198	5,699,605	130,567	766,562	7,248,472	68,180	1,922,999	
1975	169,294	167,240	19,453	4,793,580	19,467	373,783	5,731,466	166,653	3,787,797	
1976	102,909	44,896	24,732	3,103,916	84,188	204,705	3,837,735	475,176	1,494,750	
1977	120,160	71,389	49,445	1,654,122	60,112	232,230	2,708,024	76,255	776,085	
1978	68,838	32,855	18,183	677,448	36,484	210,198	1,711,657	57,463	131,076	
1979	36,225	18,948	10,675	560,506	10,634	103,615	1,754,670	29,960	80,482	
1980	284,545	133,526	121,171	2,239,224	60,229	559,963	5,914,309	31,462	181,638	
1981	32,214	13,223	6,466	(774,614)	138,917	203,941	1,737,796	5,864	69,031	
1982	77,988	13,158	14,459	432,274	346,905	79,819	8,717,959	9,224	159,280	
1983	58,714	25,900	10,363	451,428	2,029,405	58,989	13,652,234	4,304	528,764	
1984	35,378	845,423	6,052	(83,811)	1,290,740	34,764	10,799,037	3,850	270,455	
1985	(232,549)	(481,017)	1,945,477	608,583	966,160	51,634	8,422,737	5,555	62,571	
1986	(2,046,222)	(1,334,975)	3,260,280	1,097,122	230,510	51,994	7,713,451	9,927	114,561	
1987	(344,829)	55,519	64,264	3,631,282	146,850	91,223	5,552,802	4,908	27,208	
1988	(147,290)	(70,564)	351,489	552,546	558,557	197,761	2,039,009	7,358	161,957	
1989	60,657	30,217	534,658	4,161,037	1,496,776	433,072	7,382,673	8,092	(2,297,399)	
1990	(403,413)	(635,623)	(97,841)	8,794,258	1,394,698	344,367	8,620,068	176,854	(1,657,576)	
1991	(18,809)	(147,369)	(17,234)	7,985,326	3,624,824	139,105	11,753,895	202,286	(1,316,160)	
1992	338,098	(263,897)	75,210	4,849,560	8,364,426	127,829	14,808,798	333,934	(1,878,502)	
1993	180,598	133,941	49,144	2,094,764	15,390,366	159,211	19,571,092	1,506,787	3,979,221	
1994	114,273	65,260	26,546	933,021	8,082,401	81,869	10,577,079	2,104,588	2,493,097	
1995	121,499	66,503	30,918	1,096,953	5,924,175	123,653	8,050,530	3,310,564	500,791	
1996	48,699	44,953	17,787	1,736,686	2,181,669	96,339	4,344,851	19,019,751	(100,474)	
1997	39,973	55,881	27,865	809,666	(342,563)	102,390	1,000,244	7,645,602	(662,524)	
1998	27,626	20,285	12,816	273,139	3,392,776	36,135	3,880,497	993,619	1,613,505	
1999	58,392	37,660	17,874	1,006,721	2,208,657	123,472	3,792,422	224,119	843,638	
2000	75,230	44,857	20,181	724,837	1,251,684	83,871	2,495,486	129,156	1,285,637	
2001	121,907	77,799	54,526	550,843	342,965	26,780	1,773,371	73,031	447,282	
2002	(82,663)	(7,369)	(43,431)	270,386	269,139	71,793	264,007	54,815	1,753,554	
2003	(7,565)	(3,239)	(3,009)	382,019	146,659	30,254	599,135	86,731	350,994	
2004	12,753	13,853	5,500	264,180	49,194	12,693	414,858	13,919	276,692	
2005	18,767	25,023	6,256	62,195	104,442	143,825	431,009	16,594	120,006	
2006	5,057	6,290	21,315	83,291	295,812	626,264	1,058,037	22,620	17,117	
2007	36,919	48,308	55,487	300,870	922,276	176,040	1,676,123	14,426	56,900	
2008	198,452	204,418	94,542	3,431,317	1,966,665	2,382,288	9,055,772	240,106	379,120	
2009	309,308	345,706	134,570	10,285,393	458,980	1,335,840	14,017,520	266,118	560,055	
2010	217,912	229,096	101,627	9,251,492	372,966	215,961	11,232,329	245,167	411,023	
2011	62,645	29,657	46,294	451,366	231,429	189,308	1,339,975	214,910	159,365	
2012	62,255	29,473	46,006	448,560	229,991	188,131	1,331,646	213,574	158,374	
2013	27,940	13,228	20,647	201,314	103,220	84,433	597,643	95,852	71,078	
2014	0	0	0	0	0	0	0	0	0	
2015	0	0	0	0	0	0	0	0	0	
<b>TOTAL</b>	<b>18,623,301</b>	<b>9,300,704</b>	<b>13,417,898</b>	<b>149,882,569</b>	<b>68,394,094</b>	<b>57,017,584</b>	<b>413,967,801</b>	<b>61,985,373</b>	<b>46,663,826</b>	

**TABLE B-10. Capital Costs of Each Aqueduct Reach to Be Reimbursed through Capital Cost Component of Transportation Charge**

(in dollars)

Sheet 7 of 8

Calendar Year	CALIFORNIA AQUEDUCT (continued)									
	SANTA ANA DIVISION (continued)				WEST BRANCH					
	Reach 28G (a)	Reach 28H	Reach 28J	Subtotal	Reach 29A	Reach 29F	Reach 29G	Reach 29H	Reach 29J	
[56]	[57]	[58]	[59]	[60]	[61]	[62]	[63]	[64]		
1952	4,785	4,055	3,020	20,793	2,924	136	175	459	553	
1953	15,580	11,511	9,476	64,106	9,093	344	237	1,754	1,683	
1954	18,015	18,100	12,160	84,631	7,389	1,201	2,229	2,350	4,162	
1955	6,052	6,081	4,151	28,546	1,019	585	1,086	1,147	2,029	
1956	6,496	6,525	4,480	30,682	490	698	1,297	1,366	2,420	
1957	24,044	24,156	16,585	113,576	1,809	2,583	4,792	5,057	8,952	
1958	40,844	41,033	28,470	193,367	3,256	4,516	8,714	8,878	15,847	
1959	45,746	45,946	44,331	233,485	7,953	9,150	19,414	18,243	35,583	
1960	59,102	58,548	118,969	395,974	21,753	14,990	34,447	29,764	69,752	
1961	32,226	34,382	674,787	825,108	22,442	12,775	21,559	20,086	39,761	
1962	21,383	20,530	47,484	135,596	40,237	28,729	86,938	58,215	108,962	
1963	43,884	41,698	1,506,440	1,735,306	91,959	69,162	163,347	110,015	211,592	
1964	89,710	45,762	98,569	506,352	150,670	66,420	207,977	143,340	291,404	
1965	96,956	76,899	146,095	805,543	361,811	77,914	403,115	127,430	589,638	
1966	170,878	308,756	589,107	1,847,811	489,512	203,497	1,233,640	348,918	3,231,797	
1967	233,968	283,126	987,832	5,327,761	1,589,715	882,096	1,117,247	891,607	31,088,491	
1968	871,337	266,295	780,587	11,450,539	3,899,363	300,921	396,190	1,104,832	36,157,768	
1969	1,117,873	1,444,654	756,442	11,895,208	6,592,580	336,480	693,348	1,184,454	9,655,871	
1970	1,843,621	1,013,468	2,829,523	15,085,092	7,986,733	6,089,401	2,624,747	3,002,968	8,463,475	
1971	16,095,702	6,401,303	12,111,623	45,555,612	4,247,037	3,768,699	1,120,231	8,244,651	5,844,024	
1972	1,537,880	11,960,791	21,542,747	41,666,145	1,871,831	426,932	985,512	18,787,722	(23,015,734)	
1973	209,664	247,769	3,673,344	6,078,500	775,824	168,064	399,856	9,408,706	1,821,206	
1974	162,178	101,638	1,980,991	4,235,986	560,657	168,878	169,717	3,901,261	(3,454,239)	
1975	157,365	124,399	1,626,274	5,862,488	353,670	421,176	925,693	664,113	609,891	
1976	178,287	118,748	1,497,465	3,764,426	396,809	650,417	1,274,484	706,244	650,209	
1977	127,106	89,036	323,091	1,391,573	390,637	3,018,637	2,152,961	196,012	1,135,148	
1978	147,112	153,867	347,482	837,000	1,427,190	2,219,135	6,694,615	57,817	149,932	
1979	29,723	19,225	225,947	385,337	940,013	2,168,382	19,813,742	597,858	331,313	
1980	137,833	154,821	1,077,900	1,583,654	1,276,793	4,108,143	24,537,814	550,337	204,751	
1981	28,815	22,654	61,349	187,713	(711,751)	2,699,873	19,806,531	94,944	28,852	
1982	16,069	58,900	55,841	299,314	(465,217)	351,251	17,964,617	215,678	42,587	
1983	18,213	89,581	(264,804)	376,058	100,394	180,971	6,751,649	220,029	24,295	
1984	14,462	12,259	49,547	350,573	71,759	68,930	2,870,259	335,942	17,285	
1985	17,816	11,481	54,070	151,493	142,244	25,386	2,126,670	102,366	21,971	
1986	31,564	25,037	86,794	267,883	133,914	62,294	274,660	141,894	36,149	
1987	17,141	8,005	45,528	102,790	13,936	453,949	711,773	192,511	27,931	
1988	41,892	21,113	90,784	323,104	427,544	118,010	1,660,959	203,130	95,930	
1989	28,708	12,619	51,556	(2,196,424)	207,067	430,662	584,186	241,811	97,472	
1990	27,478	12,817	55,408	(1,385,019)	197,428	355,480	386,882	813,211	54,269	
1991	142,139	15,524	62,794	(893,417)	219,321	344,386	453,336	1,132,520	55,176	
1992	34,185	13,422	69,479	(1,427,482)	541,026	295,312	464,421	4,402,524	47,182	
1993	44,300	27,047	162,854	5,720,209	464,987	320,182	643,189	3,361,457	74,198	
1994	16,351	11,673	54,581	4,680,290	203,666	231,527	362,717	306,148	33,758	
1995	35,402	28,202	164,254	4,039,213	344,358	392,647	536,253	468,656	34,007	
1996	76,723	73,629	344,747	19,414,376	150,901	161,394	427,223	203,201	15,357	
1997	50,662	20,720	268,293	7,322,753	298,002	71,310	432,940	276,180	50,095	
1998	10,268	8,970	479,138	3,105,500	346,973	21,003	2,028,979	181,951	49,377	
1999	84,683	45,293	324,223	1,521,956	296,520	37,641	1,080,682	125,373	51,213	
2000	64,095	41,331	114,224	1,634,443	212,174	33,747	238,676	116,588	13,241	
2001	20,193	13,635	88,656	642,797	43,281	6,448	104,127	110,850	10,737	
2002	53,787	12,619	196,949	2,071,724	171,190	30,767	252,912	60,146	7,881	
2003	1,096,665	2,482,178	179,465	4,196,033	50,516	9,140	103,157	57,710	51,000	
2004	1,736,590	856,794	24,931	2,908,926	48,551	6,994	28,690	108,375	216,380	
2005	2,049,472	409,829	270,555	2,866,456	273,242	12,511	53,630	6,256	51,947	
2006	2,302,499	408,907	2,573,468	5,324,611	661,248	25,216	131,439	2,013	2,302,784	
2007	271	1,106,165	3,671,972	4,849,734	108,828	73,936	1,992,808	270,552	7,400	
2008	3,514,339	124,823	4,936,085	9,194,473	1,867,250	325,781	604,504	997,505	304,102	
2009	2,018,490	138,346	65,406,337	68,389,346	1,087,417	1,280,662	736,474	356,712	337,048	
2010	1,065,059	127,454	141,204,245	143,052,948	220,626	1,099,563	628,612	306,280	310,513	
2011	106,995	111,724	197,885	790,879	140,682	113,654	455,525	225,689	272,190	
2012	106,330	111,030	196,655	785,963	139,807	112,948	452,693	224,287	270,498	
2013	47,721	49,830	88,259	352,740	62,746	50,691	203,169	100,660	121,400	
2014	0	0	0	0	0	0	0	0	0	
2015	0	0	0	0	0	0	0	0	0	
<b>TOTAL</b>	<b>38,444,727</b>	<b>29,636,733</b>	<b>274,431,494</b>	<b>451,162,153</b>	<b>41,591,799</b>	<b>35,024,327</b>	<b>130,649,462</b>	<b>66,138,753</b>	<b>79,390,466</b>	

a) Includes excess capacity costs (not shown in Table B-9) allocated to MWDSC in the following years and repaid under Article 24(c) of its contract: 1970 - \$362,000; 1971 - \$6,198,000; 1972 - \$139,000.

**TABLE B-10. Capital Costs of Each Aqueduct Reach to Be Reimbursed through Capital Cost Component of Transportation Charge**

(in dollars)

Sheet 8 of 8

Calendar Year	CALIFORNIA AQUEDUCT (continued)											GRAND TOTAL
	WEST BRANCH (cont.)		COASTAL BRANCH								Total	
	Reach 30	Subtotal	Reach 31A	Reach 33A	Reach 33B	Reach 34	Reach 35	Reach 37	Reach 38	Subtotal		
[65]	[66]	[67]	[68]		[69]	[70]	[71]	[72]	[73]	[74]	[75]	
1952	1,408	5,655	0	0	0	0	0	0	0	0	98,857	99,353
1953	4,346	17,457	0	0	0	0	0	0	0	0	309,387	311,812
1954	5,743	23,074	0	0	0	0	0	0	0	0	394,688	402,143
1955	1,943	7,809	0	0	0	0	0	0	0	0	159,842	169,342
1956	2,077	8,348	0	0	0	0	0	0	0	0	255,679	351,551
1957	7,684	30,877	0	0	0	0	0	0	0	0	708,753	1,464,452
1958	13,931	55,142	0	0	0	0	0	0	0	0	1,331,616	2,286,623
1959	44,384	134,727	28,046	49,114	0	7,441	8,236	0	0	92,837	2,096,392	2,967,412
1960	84,703	255,409	34,404	70,450	0	8,507	14,265	0	0	127,626	2,937,049	4,660,833
1961	123,330	239,953	13,801	17,868	0	1,501	3,931	0	0	37,101	4,650,264	8,545,244
1962	348,366	671,447	10,121	7,798	0	524	1,689	0	0	20,132	5,827,774	8,875,171
1963	521,491	1,167,566	20,470	14,299	0	880	2,943	0	0	38,592	18,981,487	24,610,278
1964	1,372,464	2,232,275	315,418	26,963	0	1,687	5,639	0	0	349,707	31,550,813	41,736,060
1965	3,383,950	4,943,858	747,023	36,178	0	2,118	7,060	0	0	792,379	57,936,405	62,664,743
1966	9,364,753	14,872,117	2,258,915	35,864	0	1,736	5,764	0	0	2,302,279	124,748,128	129,110,330
1967	17,618,827	53,187,979	6,310,419	38,331	0	1,891	6,213	0	0	6,356,854	187,465,580	194,146,365
1968	15,736,691	57,595,765	2,707,580	30,784	0	1,324	4,369	0	0	2,744,057	192,593,079	197,978,911
1969	16,228,175	34,690,908	423,797	26,549	0	907	2,905	0	0	454,158	182,530,023	184,473,490
1970	22,330,328	50,497,652	269,194	24,368	0	851	2,787	0	0	297,200	206,720,774	207,082,650
1971	16,890,503	40,115,145	164,446	32,230	0	1,315	3,804	0	0	201,795	158,414,033	158,624,739
1972	3,818,001	2,874,264	131,332	17,601	0	522	1,660	0	0	151,115	68,228,670	68,362,291
1973	13,426,222	25,999,878	182,493	16,154	0	542	1,758	0	0	200,947	45,110,823	45,263,853
1974	2,988,318	4,334,592	190,866	18,799	0	463	1,405	0	0	211,533	24,036,199	24,402,166
1975	1,808,235	4,782,778	64,582	36,012	0	2,255	6,656	0	0	109,505	21,065,768	21,318,838
1976	1,253,067	4,931,230	198,266	68,898	0	5,088	14,988	0	0	287,240	17,183,961	17,492,910
1977	345,023	7,238,418	918,473	81,305	0	1,834	5,387	0	0	1,006,999	15,165,801	15,544,382
1978	763,445	11,312,134	52,994	83,300	0	1,302	3,852	0	0	141,448	18,661,117	19,119,151
1979	282,145	24,133,453	38,182	108,951	0	1,505	4,433	0	0	153,071	31,202,118	31,857,362
1980	2,055,206	32,733,044	189,070	376,036	0	1,152	3,449	0	0	569,707	73,891,101	74,986,833
1981	275,460	22,193,909	19,897	(157,537)	0	1,427	4,261	0	0	(131,952)	15,246,649	15,742,773
1982	351,376	18,460,292	(16,381)	(96,449)	0	588	1,787	0	0	(110,455)	38,256,580	39,705,931
1983	566,545	7,843,883	85,496	67,106	0	794	2,398	0	0	155,794	34,705,281	38,044,649
1984	1,118,954	4,483,129	28,568	54,074	0	986	2,959	0	0	86,587	24,454,091	30,382,250
1985	284,243	2,702,880	36,834	54,314	0	2,111	6,263	0	0	99,522	14,914,930	28,537,556
1986	213,353	862,264	82,358	223,134	0	17,458	51,279	0	0	374,229	13,435,351	43,155,828
1987	158,313	1,558,413	53,817	1,061,939	0	92,506	272,968	0	0	1,481,230	11,711,428	34,331,982
1988	222,068	2,727,641	183,853	1,141,272	0	99,456	293,612	0	0	1,718,193	11,026,370	18,123,243
1989	148,674	1,709,872	84,678	893,765	0	77,283	228,038	0	0	1,283,764	30,302,112	33,130,497
1990	119,438	1,926,708	133,868	1,100,167	0	103,785	277,889	0	0	1,615,709	32,589,619	34,435,721
1991	229,315	2,434,054	164,610	1,635,283	0	123,603	363,889	0	0	2,287,385	38,320,942	39,811,664
1992	206,495	5,956,960	183,240	1,220,510	1,495,646	566,230	240,553	102,051	74,162	3,882,392	34,312,996	35,041,233
1993	296,349	5,160,362	344,928	5,274,657	5,052,431	1,345,211	688,935	268,937	358,367	13,333,467	53,122,385	53,921,788
1994	168,426	1,306,242	282,150	15,905,886	21,341,196	8,915,445	2,363,238	678,753	1,315,559	50,802,227	73,751,564	74,225,377
1995	304,983	2,080,904	1,196,326	45,172,271	62,947,362	23,975,738	20,849,939	7,029,108	7,117,197	168,287,940	191,033,089	191,525,570
1996	98,522	1,056,598	948,730	42,987,442	54,300,990	26,475,298	18,790,572	7,213,823	6,616,310	157,333,164	187,776,346	188,025,324
1997	233,956	1,362,483	562,583	11,209,633	13,893,576	10,456,863	4,149,105	545,378	798,606	41,615,744	62,137,369	62,583,537
1998	67,874	2,696,157	248,671	2,355,322	4,159,441	3,368,320	952,615	192,567	280,779	11,557,715	27,083,446	27,217,157
1999	118,013	1,709,442	288,236	2,906,010	4,398,935	2,616,574	356,318	36,680	51,648	10,654,401	24,085,344	24,556,054
2000	187,926	802,352	132,435	228,901	2,965,936	2,746,120	17,830	0	0	6,091,222	13,504,772	13,742,556
2001	23,847	299,290	103,281	(7,057)	568,968	3,960	(1,112)	0	0	668,040	5,130,622	7,470,509
2002	62,684	585,580	98,021	147,827	105,972	77,266	13,119	0	0	442,205	8,836,703	17,138,613
2003	34,280	305,803	42,071	43,753	31,706	25,734	6,272	0	0	149,536	3,109,548	10,874,362
2004	17,442	426,432	27,034	14,576	22,446	3,605	2,229	0	0	69,890	5,140,297	11,328,188
2005	593,265	990,851	29,204	(262,373)	37,518	0	0	0	0	(195,651)	8,101,614	11,757,610
2006	167,744	3,290,444	7,660	574,601	37,543	95,619	109,813	0	0	825,236	16,732,965	22,224,522
2007	37,600	2,491,124	38,805	1,282,620	42,768	210,275	202,053	0	0	1,776,521	15,951,332	24,659,139
2008	927,117	5,026,259	288,997	762,241	717,606	343,514	213,111	0	0	2,325,469	39,070,459	58,291,726
2009	5,814,938	9,613,251	460,840	967,493	795,350	380,730	236,199	0	0	2,840,612	113,406,009	123,824,741
2010	12,682,001	15,247,595	319,115	799,282	732,733	350,755	217,604	0	0	2,419,489	188,994,253	193,012,913
2011	508,400	1,716,140	77,835	524,402	642,302	307,466	190,748	0	0	1,742,753	8,771,318	9,498,195
2012	505,240	1,705,473	77,351	521,142	638,310	305,555	189,562	0	0	1,731,920	8,716,801	9,439,159
2013	226,752	765,418	34,715	233,889	286,473	137,133	85,076	0	0	777,286	3,912,102	4,236,298
2014	0	0	0	0	0	0	0	0	0	0	0	0
2015	0	0	0	0	0	0	0	0	0	0	0	0
<b>TOTAL</b>	<b>157,796,352</b>	<b>510,591,159</b>	<b>21,919,718</b>	<b>140,057,948</b>	<b>175,215,208</b>	<b>83,272,753</b>	<b>51,492,315</b>	<b>16,067,297</b>	<b>16,612,628</b>	<b>504,637,867</b>	<b>2,851,900,869</b>	<b>3,078,905,954</b>

**TABLE B-11. Minimum OMP&R Costs of Each Aqueduct Reach to Be Reimbursed through Minimum OMP&R Component of Transportation Charge**

(in dollars)

Sheet 1 of 9

Calendar Year	UPPER FEATHER DIVISION	NORTH BAY AQUEDUCT					SOUTH BAY AQUEDUCT			
		Reach 1	Reach 2	Reach 3A	Reach 3B	Total	Reach 1	Reach 2	Reach 4	Reach 5
		[1]	[2]	[3]	[4]	[5]	[6]	[7]	[8]	[9]
1961	0	0	0	0	0	0	0	0	0	0
1962	0	0	0	0	0	0	37,396	5,522	0	0
1963	0	0	0	0	0	0	147,719	20,639	0	0
1964	0	0	0	0	0	0	149,750	15,574	19,405	0
1965	0	0	0	0	0	0	259,939	45,718	46,485	0
1966	0	0	0	0	0	0	270,890	23,799	63,921	0
1967	0	0	0	0	0	0	438,050	32,798	108,127	0
1968	0	0	0	0	130	130	410,919	44,277	66,973	706
1969	0	0	0	0	80,875	80,875	487,377	48,339	75,644	706
1970	0	0	0	0	94,872	94,872	381,734	44,852	64,833	71,376
1971	54	0	0	0	45,579	45,579	357,850	25,666	50,344	38,735
1972	40	0	0	0	37,895	37,895	347,941	30,606	56,800	100,106
1973	1	0	0	0	32,993	32,993	386,897	36,172	58,288	28,810
1974	143	0	0	0	46,498	46,498	456,381	57,081	83,120	61,623
1975	1,069	0	0	0	37,707	37,707	624,989	46,111	81,361	36,682
1976	139	0	0	0	60,786	60,786	614,362	47,862	123,838	91,096
1977	892	0	0	0	78,400	78,400	511,065	48,926	104,280	102,083
1978	39	0	0	0	56,318	56,318	671,195	125,224	176,855	50,289
1979	3,235	0	0	0	73,852	73,852	650,826	76,849	212,826	91,380
1980	416	0	0	0	81,769	81,769	1,128,840	212,974	242,118	110,786
1981	3,847	0	0	0	101,340	101,340	884,763	130,126	167,118	204,772
1982	11,075	0	0	0	191,987	191,987	1,156,605	141,718	249,447	96,020
1983	1,928	0	0	0	80,215	80,215	1,258,144	84,360	373,875	152,255
1984	3,765	0	0	0	139,121	139,121	1,998,984	113,797	340,344	34,461
1985	2,888	0	0	0	259,515	259,515	2,044,121	207,478	427,930	247,308
1986	2,787	0	0	0	229,508	229,508	1,834,838	285,908	305,149	159,054
1987	2,388	0	0	0	310,683	310,683	2,118,974	163,714	400,547	283,067
1988	545	0	(94)	0	330,156	330,062	2,068,655	186,275	299,934	370,212
1989	1,800	473,408	178,069	237,480	373,427	1,262,384	2,164,688	163,481	320,734	497,038
1990	788	556,610	244,897	123,144	427,257	1,351,908	2,233,036	251,434	355,022	571,415
1991	3,654	651,307	302,327	205,516	428,470	1,587,620	1,806,699	152,509	95,745	93,986
1992	647	443,912	189,330	265,462	280,505	1,179,209	2,064,907	405,932	409,435	363,964
1993	3,630	435,240	294,416	213,267	289,206	1,232,129	3,925,050	621,712	480,832	399,558
1994	2,279	430,112	198,322	206,594	365,646	1,200,674	4,673,275	302,115	404,709	408,066
1995	2,906	428,313	282,898	151,703	295,326	1,158,240	3,849,620	316,905	566,447	330,706
1996	8,007	796,526	272,743	240,106	260,001	1,569,376	3,526,989	254,075	664,485	493,300
1997	7,449	504,476	210,763	213,211	315,374	1,243,824	3,010,809	189,269	591,540	230,371
1998	7,988	404,834	227,562	204,821	251,154	1,088,371	2,965,219	426,872	532,042	303,263
1999	416	668,954	326,989	296,605	288,169	1,580,717	3,701,631	472,798	429,082	414,830
2000	505	920,906	255,241	658,168	414,700	2,249,015	3,817,480	542,905	442,515	552,538
2001	319	1,072,623	229,820	455,870	181,522	1,939,835	2,909,692	272,876	290,330	391,186
2002	3,627	1,588,349	416,749	411,379	399,274	2,815,751	3,865,610	343,132	468,352	543,896
2003	3,393	1,777,671	545,908	567,857	354,476	3,245,912	2,352,793	366,393	576,229	964,902
2004	3,455	1,602,507	635,773	738,104	818,511	3,794,895	3,345,983	511,123	747,800	701,961
2005	3,452	1,071,123	323,331	774,755	414,332	2,583,541	3,330,204	263,607	428,998	814,086
2006	3,979	797,254	230,754	591,582	419,709	2,039,299	3,199,184	360,138	707,986	656,135
2007	3,955	1,018,152	984,200	705,870	199,762	2,907,984	4,598,348	445,637	747,980	739,988
2008	3,213	1,006,531	329,249	672,790	431,429	2,439,999	3,908,489	410,882	629,033	922,264
2009	1,836	1,095,321	353,115	731,470	471,007	2,650,913	4,379,747	448,390	681,052	986,042
2010	1,926	1,099,918	375,939	743,438	459,385	2,678,680	4,322,189	481,987	728,808	1,047,240
2011	4,704	1,122,486	313,033	560,774	472,623	2,468,916	4,965,439	580,128	936,244	811,423
2012	4,704	1,122,793	313,080	560,933	472,732	2,469,538	4,966,316	580,227	936,419	811,707
2013	4,704	1,123,783	313,100	561,446	473,011	2,471,340	4,967,364	580,330	936,675	812,814
2014	4,703	1,124,581	312,926	561,880	473,125	2,472,512	4,965,732	580,114	936,462	814,004
2015	4,705	1,125,417	313,172	562,297	473,482	2,474,368	4,969,577	580,563	937,184	814,590
2016	4,702	1,123,881	312,841	561,520	472,891	2,471,133	4,964,052	579,923	936,119	813,330
2017	4,703	1,124,527	312,959	561,849	473,128	2,472,463	4,966,083	580,156	936,515	813,891
2018	4,704	1,125,696	312,981	562,455	473,452	2,474,574	4,967,315	580,278	936,816	815,194
2019	4,698	1,123,994	312,692	561,590	472,840	2,471,116	4,962,191	579,692	935,809	813,688
2020	4,704	1,124,917	313,021	562,048	473,268	2,473,254	4,967,203	580,282	936,739	814,248
2021	4,707	1,125,317	313,264	562,236	473,510	2,474,327	4,970,666	580,698	937,361	814,334
2022	4,703	1,125,402	312,936	562,309	473,350	2,473,997	4,966,464	580,181	936,651	814,938
2023	4,702	1,123,939	312,882	561,548	472,932	2,471,301	4,964,626	579,994	936,222	813,331
2024	4,702	1,124,565	312,880	561,874	473,097	2,472,416	4,965,093	580,033	936,351	814,055
2025	4,707	1,125,691	313,241	562,433	473,595	2,474,960	4,970,660	580,687	937,389	814,799
2026	4,697	1,123,663	312,603	561,426	472,703	2,470,395	4,960,774	579,527	935,543	813,443
2027	4,714	1,127,189	313,691	563,180	474,247	2,478,307	4,977,729	581,517	938,714	815,832
2028	4,697	1,123,633	312,522	561,418	472,652	2,470,225	4,959,698	579,396	935,354	813,533
2029	4,704	1,124,920	313,081	562,042	473,301	2,473,344	4,967,993	580,380	936,874	814,155
2030	4,702	1,123,732	312,845	561,441	472,856	2,470,874	4,963,973	579,914	936,093	813,150
2031	4,713	1,127,789	313,624	563,497	474,370	2,479,280	4,977,341	581,454	938,695	816,627
2032	4,694	1,123,019	312,332	561,113	472,381	2,468,845	4,956,723	579,046	934,798	813,122
2033	4,705	1,124,915	313,213	562,031	473,375	2,473,534	4,969,721	580,590	937,169	813,944
2034	4,704	1,125,362	313,114	562,272	473,437	2,474,185	4,968,782	580,466	937,042	814,612
2035	4,694	1,123,162	312,385	561,181	472,448	2,469,176	4,957,535	579,144	934,951	813,204
TOTAL	214,861	46,958,410	15,232,719	23,455,985	22,337,647	107,984,761	219,809,896	24,811,257	38,912,907	35,106,230

**TABLE B-11. Minimum OMP&R Costs of Each Aqueduct Reach to Be Reimbursed through Minimum OMP&R Component of Transportation Charge**

(in dollars)

Sheet 2 of 9

Calendar Year	SOUTH BAY AQUEDUCT (continued)					CALIFORNIA AQUEDUCT			
						NORTH SAN JOAQUIN DIVISION			
	Reach 6	Reach 7	Reach 8	Reach 9	Total	Reach 1	Reach 2A	Reach 2B	Subtotal
[11]	[12]	[13]	[14]	[15]	[16]	[17]	[18]	[19]	
1961	0	0	0	0	0	0	0	0	0
1962	0	0	0	0	42,918	0	0	0	0
1963	0	0	0	0	168,358	0	0	0	0
1964	0	0	0	0	184,729	0	0	0	0
1965	2,634	6,490	4,704	12,904	378,874	0	0	0	0
1966	4,707	10,328	9,233	25,519	408,397	0	0	0	0
1967	2,712	7,659	10,812	34,347	634,505	0	0	0	0
1968	3,109	7,960	10,166	40,372	584,482	1,001,998	228,359	103,116	1,333,473
1969	3,944	5,975	8,795	38,566	669,346	933,116	301,596	188,194	1,422,906
1970	2,464	(1,991)	6,870	28,210	598,348	971,602	306,198	151,539	1,429,339
1971	3,116	9,394	9,895	31,068	526,068	1,103,021	254,786	113,694	1,471,501
1972	5,125	10,247	12,054	44,699	607,578	1,107,855	230,906	110,109	1,448,870
1973	4,178	7,500	4,890	43,816	570,551	1,150,864	221,445	100,221	1,472,530
1974	7,812	7,564	5,523	48,054	727,158	1,272,034	231,383	117,156	1,620,573
1975	18,120	14,683	18,325	68,377	908,648	1,434,736	455,110	201,075	2,090,921
1976	10,873	5,557	19,920	49,921	963,429	1,519,801	217,348	453,400	2,190,549
1977	(240)	2,228	8,391	89,579	866,312	1,913,643	292,380	196,564	2,402,587
1978	(1,404)	16,766	(5,313)	104,078	1,137,690	1,860,456	306,503	188,214	2,355,173
1979	1,269	29,294	7,351	106,835	1,176,630	1,848,109	231,339	145,205	2,224,653
1980	3,621	24,270	17,404	110,852	1,850,865	2,365,292	472,660	247,608	3,085,560
1981	4,038	20,109	17,586	98,143	1,526,655	2,649,730	435,226	154,191	3,239,147
1982	2,236	22,870	21,919	202,590	1,893,405	3,192,710	599,793	244,664	4,037,167
1983	(2,047)	48,781	45,573	216,434	4,244,937	4,244,937	802,908	273,081	5,320,926
1984	4,449	44,017	23,563	455,054	3,014,669	4,373,157	808,917	290,728	5,472,802
1985	13,097	74,565	57,920	238,067	3,310,486	4,717,323	629,825	189,199	5,536,347
1986	11,614	31,084	46,864	363,350	3,037,861	5,217,491	929,919	359,365	6,506,775
1987	15,273	25,182	37,949	416,375	3,461,081	5,292,200	958,927	362,065	6,613,192
1988	30,207	41,047	49,156	335,408	3,380,894	5,329,317	822,300	360,336	6,511,953
1989	9,740	54,881	114,203	179,323	3,504,088	5,753,966	851,745	907,609	7,513,320
1990	31,161	69,416	119,309	247,781	3,878,574	6,788,986	1,066,314	883,822	8,739,122
1991	22,434	(18,690)	99,577	262,052	2,514,312	6,796,247	1,067,078	585,008	8,448,333
1992	26,787	332,012	98,670	186,640	3,888,347	9,415,121	1,419,603	673,833	11,508,557
1993	24,845	181,592	94,169	316,045	6,043,803	10,274,070	1,371,074	900,996	12,546,140
1994	28,383	90,791	80,942	416,061	6,404,342	8,451,199	1,325,511	802,217	10,578,927
1995	29,298	64,012	80,278	373,657	5,610,923	10,406,784	2,386,507	959,685	13,752,976
1996	(1,020)	60,610	11,672	312,097	5,322,208	10,246,985	2,604,651	628,177	13,479,813
1997	18,428	95,321	15,691	335,566	4,486,995	10,429,338	1,098,381	2,084,859	13,612,578
1998	26,323	54,255	611,290	658,090	5,577,354	11,409,135	1,449,411	5,364,368	18,222,914
1999	49,762	34,829	426,694	2,030,604	7,560,230	11,446,675	1,365,947	1,301,570	14,114,192
2000	135,909	87,815	185,985	641,445	6,406,592	12,637,999	905,934	648,421	14,192,354
2001	112,970	188,989	197,745	1,048,191	5,411,979	17,559,077	1,375,177	752,734	19,686,988
2002	143,886	171,491	501,630	2,781,431	8,819,428	14,429,951	861,125	622,521	15,913,597
2003	78,084	97,968	248,068	987,782	5,672,219	16,534,136	1,724,007	749,673	19,007,816
2004	156,691	179,277	205,603	454,479	6,302,917	14,177,440	1,308,095	733,356	16,218,891
2005	143,201	202,487	135,676	224,601	5,542,860	12,536,405	1,936,095	874,120	15,346,620
2006	141,030	121,599	77,961	386,943	5,650,976	13,924,419	1,701,718	1,181,786	16,807,923
2007	58,362	125,912	62,380	256,133	7,034,740	10,841,045	2,109,920	946,325	13,897,290
2008	128,102	148,090	148,384	414,439	6,709,683	16,347,038	1,896,797	1,202,238	19,446,073
2009	134,725	156,625	168,149	465,650	7,420,380	19,427,623	2,043,087	1,342,253	22,812,963
2010	141,838	165,433	184,449	508,517	7,580,461	16,522,768	2,179,094	3,185,465	21,887,327
2011	110,056	101,986	123,966	608,305	8,237,547	13,755,125	2,622,094	873,586	17,250,805
2012	110,074	102,001	123,983	608,397	8,239,124	13,757,186	2,622,677	873,774	17,253,637
2013	110,076	102,007	123,991	608,427	8,241,684	13,761,633	2,624,804	874,428	17,260,865
2014	110,014	101,947	123,918	608,074	8,240,265	13,762,180	2,626,904	875,039	17,264,123
2015	110,099	102,025	124,016	608,550	8,246,604	13,769,578	2,628,259	875,495	17,273,332
2016	109,985	101,920	123,886	607,910	8,237,125	13,757,879	2,625,536	874,609	17,258,024
2017	110,025	101,958	123,930	608,136	8,240,694	13,762,432	2,626,723	874,989	17,264,144
2018	110,032	101,964	123,938	608,170	8,243,707	13,767,655	2,629,224	875,757	17,272,636
2019	109,931	101,869	123,824	607,613	8,234,617	13,755,945	2,626,078	874,750	17,256,773
2020	110,045	101,977	123,957	608,256	8,242,707	13,765,057	2,627,459	875,223	17,267,739
2021	110,132	102,056	124,053	608,729	8,248,029	13,770,591	2,627,848	875,384	17,273,823
2022	110,016	101,947	123,919	608,078	8,242,194	13,765,696	2,628,690	875,589	17,269,975
2023	109,998	101,934	123,902	607,988	8,237,995	13,758,759	2,625,577	874,627	17,258,963
2024	109,996	101,931	123,898	607,978	8,239,335	13,761,333	2,626,960	875,048	17,263,341
2025	110,122	102,049	124,040	608,680	8,248,426	13,771,773	2,628,717	875,645	17,276,135
2026	109,899	101,843	123,789	607,439	8,232,257	13,753,149	2,625,524	874,566	17,253,239
2027	110,282	102,196	124,221	609,559	8,260,050	13,785,261	2,631,125	876,453	17,292,839
2028	109,871	101,815	123,756	607,281	8,230,704	13,751,730	2,626,620	874,580	17,251,930
2029	110,067	101,997	123,981	608,375	8,243,822	13,766,036	2,627,335	875,197	17,268,568
2030	109,986	101,921	123,887	607,917	8,236,841	13,757,299	2,625,197	874,504	17,257,000
2031	110,258	102,173	124,194	609,419	8,260,161	13,786,693	2,632,568	876,882	17,296,143
2032	109,803	101,752	123,681	606,907	8,225,832	13,746,107	2,624,649	874,253	17,245,009
2033	110,115	102,041	124,033	608,637	8,246,250	13,768,145	2,627,061	875,135	17,270,341
2034	110,079	102,008	123,992	608,435	8,245,416	13,768,416	2,628,241	875,481	17,272,138
2035	109,823	101,771	123,703	607,013	8,227,144	13,747,565	2,624,856	874,324	17,246,745
TOTAL	4,542,630	5,685,382	7,416,533	31,894,418	368,179,253	663,929,022	109,454,825	53,756,078	827,139,925

**TABLE B-11. Minimum OMP&R Costs of Each Aqueduct Reach to Be Reimbursed through Minimum OMP&R Component of Transportation Charge**

(in dollars)

Sheet 3 of 9

Calendar Year	CALIFORNIA AQUEDUCT (continued)								
	SAN LUIS DIVISION						SOUTH SAN JOAQUIN DIVISION		
	Reach 3 [20]	Reach 4 [21]	Reach 5 [22]	Reach 6 [23]	Reach 7 [24]	Subtotal [25]	Reach 8C [26]	Reach 8D [27]	Reach 9 [28]
1961	0	0	0	0	0	0	0	0	0
1962	0	0	0	0	0	0	0	0	0
1963	0	0	0	0	0	0	0	0	0
1964	0	0	0	0	0	0	0	0	0
1965	0	0	0	0	0	0	0	0	0
1966	0	0	0	0	0	0	0	0	0
1967	0	0	0	0	0	0	0	0	0
1968	120,038	428,308	130,105	44,591	104,033	827,075	0	0	0
1969	90,033	460,907	184,467	35,696	235,322	1,006,425	22,013	134,760	86,103
1970	89,547	484,300	226,002	66,070	192,582	1,058,501	26,207	156,981	128,273
1971	99,917	541,574	175,592	64,193	158,170	1,039,446	32,312	190,753	118,372
1972	116,708	647,979	174,519	73,670	154,783	1,167,659	35,031	187,242	130,396
1973	116,791	611,705	158,145	58,344	153,955	1,098,940	51,150	225,747	127,530
1974	120,309	671,455	150,835	63,905	150,230	1,156,734	34,752	199,127	131,298
1975	133,593	839,285	178,974	81,478	157,586	1,390,916	78,523	250,377	159,006
1976	54,938	883,956	220,832	90,305	174,835	1,424,866	39,348	133,933	123,424
1977	73,331	1,114,465	270,734	98,132	196,311	1,752,973	38,086	121,348	178,078
1978	45,867	898,992	203,261	106,938	203,079	1,458,137	45,552	178,805	129,928
1979	223,973	842,508	144,055	99,670	180,734	1,490,940	69,973	150,679	129,756
1980	243,507	1,176,463	222,942	127,625	281,860	2,052,397	57,726	274,848	185,155
1981	265,766	1,065,358	193,048	90,533	1,612,157	3,226,862	80,121	198,256	144,187
1982	279,250	1,241,285	209,371	114,421	1,433,180	3,277,507	59,424	269,086	233,494
1983	214,468	1,949,017	339,809	131,377	2,143,678	4,778,349	49,448	383,476	223,078
1984	241,273	2,233,969	335,166	163,858	2,111,386	5,085,652	42,062	458,489	300,924
1985	322,068	2,882,583	360,431	176,577	1,603,532	5,345,191	58,820	495,500	213,368
1986	416,027	2,996,792	472,551	252,188	601,250	4,738,808	90,730	478,786	596,800
1987	362,738	3,104,592	424,107	236,349	439,232	4,567,018	113,962	412,042	446,067
1988	365,209	2,954,186	456,864	231,754	639,242	4,647,255	96,728	379,073	417,991
1989	263,171	3,182,472	393,589	332,986	633,419	4,805,637	83,282	389,698	400,853
1990	397,353	4,011,110	579,073	464,639	729,132	6,181,307	111,019	436,849	515,611
1991	256,473	4,388,184	543,760	728,156	765,765	6,682,338	104,414	496,794	465,940
1992	302,021	3,792,401	795,587	363,134	815,590	6,068,733	118,315	511,982	417,871
1993	439,725	4,337,616	1,008,394	551,849	734,796	7,072,380	230,338	745,885	490,159
1994	282,579	4,376,461	816,129	396,768	492,860	6,364,797	125,398	602,404	572,555
1995	107,995	5,026,076	1,066,971	440,006	1,356,668	7,997,716	185,681	657,282	432,072
1996	1,003,229	4,738,221	931,944	683,323	1,034,376	8,391,093	112,062	416,294	472,350
1997	859,665	5,761,996	924,289	254,934	646,209	8,447,093	128,190	449,316	728,436
1998	690,845	5,520,206	1,242,589	534,931	654,538	8,643,109	115,748	457,845	429,433
1999	697,893	5,684,969	1,219,793	531,972	670,006	8,804,633	104,822	396,623	409,411
2000	712,071	5,849,518	1,033,992	528,537	876,030	9,000,148	104,381	467,347	513,824
2001	(558,917)	7,151,253	851,983	373,030	679,856	8,497,205	58,436	553,295	603,147
2002	1,071,739	5,193,633	673,240	255,190	738,467	7,932,269	55,252	729,942	417,109
2003	1,026,535	6,039,979	750,339	304,182	620,749	8,741,784	62,618	674,449	643,946
2004	655,509	7,033,601	725,042	344,853	606,863	9,365,868	37,161	484,074	337,980
2005	543,533	6,050,102	976,242	396,412	793,183	8,759,472	28,760	405,593	298,717
2006	1,148,263	6,131,086	1,551,613	620,757	932,463	10,384,182	49,270	617,318	879,869
2007	995,341	7,328,519	2,074,995	758,915	905,046	12,092,816	205,263	1,015,736	551,199
2008	1,460,343	11,155,764	2,266,544	831,781	1,151,751	16,866,183	99,434	658,078	685,028
2009	1,429,933	14,392,031	2,326,837	855,606	1,191,556	20,195,963	103,933	686,350	714,639
2010	1,432,558	10,783,614	2,314,613	856,100	1,214,186	16,601,071	109,010	718,258	748,057
2011	986,720	5,551,658	1,188,475	560,197	764,972	9,052,022	331,363	1,259,926	1,033,432
2012	987,149	5,553,783	1,188,657	560,389	765,223	9,055,201	331,418	1,260,293	1,033,754
2013	989,343	5,562,725	1,188,716	561,129	766,161	9,068,074	331,457	1,261,530	1,034,905
2014	992,301	5,572,961	1,188,026	561,913	767,119	9,082,320	331,303	1,262,629	1,036,018
2015	992,750	5,576,909	1,188,956	562,321	767,677	9,088,613	331,561	1,263,563	1,036,779
2016	991,189	5,567,765	1,187,708	561,457	766,528	9,074,647	331,201	1,261,788	1,035,268
2017	991,979	5,571,956	1,188,146	561,841	767,033	9,080,955	331,330	1,262,545	1,035,922
2018	994,560	5,582,450	1,188,215	562,711	768,135	9,096,071	331,378	1,264,000	1,037,279
2019	992,382	5,571,189	1,187,127	561,688	766,792	9,079,178	331,057	1,262,007	1,035,547
2020	992,513	5,574,628	1,188,378	562,083	767,348	9,084,950	331,400	1,263,008	1,036,326
2021	991,942	5,574,519	1,189,307	562,153	767,482	9,085,403	331,647	1,263,386	1,036,570
2022	994,181	5,580,525	1,188,036	562,538	767,906	9,093,186	331,325	1,263,663	1,036,984
2023	991,068	5,567,639	1,187,863	561,459	766,540	9,074,569	331,243	1,261,836	1,035,296
2024	992,557	5,573,553	1,187,842	561,948	767,151	9,083,051	331,254	1,262,630	1,036,043
2025	992,963	5,578,386	1,189,209	562,462	767,866	9,090,886	331,632	1,263,869	1,037,033
2026	992,152	5,569,489	1,186,790	561,520	766,563	9,076,514	330,963	1,261,632	1,035,236
2027	993,692	5,585,286	1,190,928	563,183	768,858	9,101,947	332,106	1,265,540	1,038,385
2028	992,585	5,570,480	1,186,478	561,576	766,616	9,077,735	330,884	1,261,635	1,035,278
2029	992,136	5,573,680	1,188,614	562,023	767,284	9,083,737	331,460	1,262,976	1,036,270
2030	990,812	5,566,304	1,187,722	561,337	766,378	9,072,553	331,202	1,261,599	1,035,086
2031	995,508	5,591,939	1,190,658	563,706	769,507	9,111,318	332,051	1,266,328	1,039,159
2032	992,328	5,567,755	1,185,752	561,289	766,217	9,073,341	330,682	1,260,956	1,034,730
2033	991,299	5,571,529	1,189,128	561,890	767,142	9,080,988	331,590	1,262,904	1,036,138
2034	992,967	5,577,280	1,188,735	562,330	767,679	9,088,991	331,503	1,263,518	1,036,763
2035	992,330	5,568,248	1,185,956	561,346	766,302	9,074,182	330,737	1,261,108	1,034,847
TOTAL	44,012,614	305,261,127	60,004,790	27,892,224	50,347,125	487,517,880	11,738,502	49,415,589	41,830,484



**TABLE B-11. Minimum OMP&R Costs of Each Aqueduct Reach to Be Reimbursed through Minimum OMP&R Component of Transportation Charge**

(in dollars)

Sheet 4 of 9

Calendar Year	CALIFORNIA AQUEDUCT (continued)									
	SOUTH SAN JOAQUIN DIVISION (continued)									
	Reach 10A	Reach 11B	Reach 12D	Reach 12E	Reach 13B	Reach 14A	Reach 14B	Reach 14C	Reach 15A	
[29]	[30]	[31]	[32]	[33]	[34]	[35]	[36]	[37]		
1961	0	0	0	0	0	0	0	0	0	0
1962	0	0	0	0	0	0	0	0	0	0
1963	0	0	0	0	0	0	0	0	0	0
1964	0	0	0	0	0	0	0	0	0	0
1965	0	0	0	0	0	0	0	0	0	0
1966	0	0	0	0	0	0	0	0	0	0
1967	0	0	0	0	0	0	0	0	0	0
1968	0	0	0	0	0	0	0	0	0	0
1969	83,706	59,077	0	0	0	0	0	0	0	0
1970	118,046	85,758	94,171	123,374	152,424	0	0	0	0	0
1971	129,811	80,282	95,075	91,389	167,142	691,791	151,979	111,623	529,723	
1972	117,625	84,287	98,647	115,592	146,096	877,535	124,831	101,479	609,058	
1973	117,706	92,257	74,238	114,843	221,385	961,855	120,106	99,429	692,748	
1974	141,658	98,103	74,914	193,523	141,540	898,272	143,866	115,649	853,098	
1975	207,908	124,105	61,799	117,194	108,154	1,156,757	180,614	119,889	988,045	
1976	139,134	69,715	33,655	147,908	134,063	1,124,051	177,086	114,133	1,037,799	
1977	194,086	108,644	91,547	175,039	137,975	1,397,006	203,837	119,467	1,339,196	
1978	168,634	106,702	72,585	170,578	151,120	1,254,043	139,662	132,224	1,265,813	
1979	175,107	85,942	56,331	174,147	150,029	1,490,461	201,935	260,981	1,216,126	
1980	284,207	120,896	123,120	167,249	164,749	1,988,619	189,132	238,607	1,437,614	
1981	199,927	76,965	33,322	113,202	171,669	1,741,488	163,934	161,182	1,799,832	
1982	264,947	158,178	142,631	224,170	224,051	1,793,867	195,086	15,768	1,933,859	
1983	308,801	136,350	124,724	203,733	217,324	2,421,794	199,708	181,879	2,550,842	
1984	396,448	163,331	108,212	188,724	245,764	3,312,127	329,490	204,332	3,215,901	
1985	298,337	198,368	154,995	194,327	360,308	3,463,178	237,127	180,068	3,627,049	
1986	422,493	248,170	242,660	346,410	349,369	3,781,427	320,984	360,156	3,574,451	
1987	488,226	334,059	325,697	469,378	322,824	3,731,912	463,757	238,813	4,080,465	
1988	532,489	290,881	220,658	374,653	318,253	3,451,893	411,110	313,806	3,746,920	
1989	733,030	268,025	207,487	595,433	380,883	3,512,884	333,996	220,978	3,751,081	
1990	651,465	363,652	225,171	480,738	480,738	4,021,727	439,953	212,851	4,381,643	
1991	716,328	328,683	269,873	371,312	433,313	4,309,082	424,704	273,169	4,566,702	
1992	574,145	334,579	270,768	409,314	423,717	4,734,368	729,211	571,412	4,270,793	
1993	723,450	413,722	278,375	496,851	594,201	5,182,830	664,063	423,780	5,266,124	
1994	703,493	346,600	239,873	482,301	445,909	4,012,614	414,899	254,393	3,727,019	
1995	881,902	405,045	242,253	622,654	507,102	4,607,154	309,283	315,905	3,973,757	
1996	984,784	367,570	238,622	519,560	604,736	4,892,967	214,773	187,784	4,331,630	
1997	1,864,113	309,696	254,080	516,115	429,771	5,094,202	209,221	275,610	4,011,366	
1998	1,011,284	295,927	170,556	384,226	484,072	4,752,549	309,440	248,178	4,694,822	
1999	1,125,514	373,814	171,495	399,331	504,020	5,041,004	351,551	231,593	4,753,855	
2000	924,210	407,081	329,756	651,715	567,781	5,957,878	343,438	141,041	5,385,171	
2001	870,742	413,016	893,071	519,027	660,369	4,701,148	(133,796)	(94,419)	6,007,151	
2002	1,309,728	381,311	295,967	959,788	862,655	5,969,394	39,304	256,180	5,598,378	
2003	817,168	338,931	233,756	690,414	612,296	6,182,663	(128,254)	24,819	6,974,013	
2004	609,367	244,096	173,363	623,894	584,409	7,283,893	(107,944)	(142,634)	8,848,430	
2005	900,730	212,859	119,774	851,677	469,847	6,309,805	(169,521)	(182,675)	5,897,939	
2006	590,234	250,291	135,307	820,342	605,497	5,734,618	344,255	113,394	6,630,051	
2007	643,116	391,784	319,686	748,782	517,228	6,288,527	817,049	251,031	9,811,907	
2008	881,175	293,170	204,948	829,005	626,993	8,126,112	365,652	216,400	10,984,008	
2009	919,608	305,578	212,744	865,795	654,161	9,376,919	380,714	225,089	8,964,905	
2010	962,984	319,582	221,541	907,317	684,823	8,100,060	397,713	234,896	7,603,304	
2011	1,049,986	786,449	714,671	1,111,428	1,168,382	7,222,409	986,313	681,364	6,879,529	
2012	1,050,145	786,666	714,938	1,111,700	1,168,701	7,224,138	986,629	681,587	6,880,939	
2013	1,050,197	787,358	716,029	1,112,434	1,169,723	7,228,736	987,799	682,444	6,883,750	
2014	1,049,590	787,913	717,256	1,112,848	1,170,543	7,231,137	988,971	683,327	6,883,594	
2015	1,050,411	788,500	717,766	1,113,687	1,171,414	7,236,590	989,693	683,821	6,888,863	
2016	1,049,307	787,423	716,610	1,112,256	1,169,817	7,227,379	988,223	682,790	6,880,692	
2017	1,049,695	787,875	717,139	1,112,838	1,170,487	7,231,094	988,866	683,242	6,883,841	
2018	1,049,755	788,686	718,417	1,113,701	1,171,687	7,236,491	990,242	684,245	6,887,136	
2019	1,048,791	787,500	717,009	1,112,198	1,169,928	7,226,849	988,536	683,038	6,879,073	
2020	1,049,901	788,151	717,469	1,113,180	1,170,893	7,233,282	989,265	683,528	6,885,636	
2021	1,050,720	788,427	717,484	1,113,699	1,171,308	7,236,746	989,462	683,636	6,889,745	
2022	1,049,598	788,485	718,179	1,113,449	1,171,390	7,234,871	989,950	684,041	6,885,792	
2023	1,049,444	787,462	716,600	1,112,337	1,169,876	7,227,910	988,246	682,797	6,881,353	
2024	1,049,425	787,901	717,321	1,112,791	1,170,524	7,230,719	989,006	683,354	6,882,936	
2025	1,050,634	788,689	717,952	1,113,945	1,171,695	7,238,271	989,937	683,992	6,890,412	
2026	1,048,496	787,270	716,792	1,111,873	1,169,582	7,224,743	988,242	682,831	6,877,089	
2027	1,052,150	789,740	718,850	1,115,464	1,173,260	7,248,158	991,216	684,870	6,900,031	
2028	1,048,220	787,247	716,902	1,111,774	1,169,550	7,224,049	988,300	682,884	6,875,984	
2029	1,050,107	788,147	717,359	1,113,238	1,170,894	7,233,708	989,192	683,468	6,886,414	
2030	1,049,320	787,316	716,431	1,112,152	1,169,661	7,226,718	988,039	682,651	6,880,340	
2031	1,051,912	790,158	719,652	1,115,837	1,173,873	7,250,396	992,019	685,466	6,900,728	
2032	1,047,578	786,818	716,549	1,111,147	1,168,910	7,219,957	987,783	682,532	6,871,966	
2033	1,050,563	788,145	717,116	1,113,361	1,170,895	7,234,607	989,031	683,331	6,888,092	
2034	1,050,215	788,458	717,804	1,113,590	1,171,352	7,235,933	989,687	683,828	6,887,980	
2035	1,047,759	786,917	716,611	1,111,302	1,169,059	7,220,977	987,892	682,606	6,873,023	
TOTAL	50,431,785	29,784,783	25,866,353	45,273,253	45,479,155	340,516,342	35,278,487	24,409,923	336,837,526	

**TABLE B-11. Minimum OMP&R Costs of Each Aqueduct Reach to Be Reimbursed through Minimum OMP&R Component of Transportation Charge**

(in dollars)

Sheet 5 of 9

Calendar Year	CALIFORNIA AQUEDUCT (continued)								
	SOUTH SAN JOAQUIN DIVISION (continued)		TEHACHAPI DIVISION			MOJAVE DIVISION			
	Reach 16A	Subtotal	Reach 17E	Reach 17F	Subtotal	Reach 18A	Reach 19	Reach 19C	Reach 20A
[38]	[39]	[40]	[41]	[42]	[43]	[44]	[45]	[46]	
1961	0	0	0	0	0	0	0	0	0
1962	0	0	0	0	0	0	0	0	0
1963	0	0	0	0	0	0	0	0	0
1964	0	0	0	0	0	0	0	0	0
1965	0	0	0	0	0	0	0	0	0
1966	0	0	0	0	0	0	0	0	0
1967	0	0	0	0	0	0	0	0	0
1968	0	0	0	0	0	0	0	0	0
1969	0	385,659	0	0	0	0	0	0	0
1970	0	885,234	0	0	0	0	0	0	0
1971	10,291	2,400,543	3,471	0	3,471	0	0	0	0
1972	1,106,884	3,734,703	1,424,782	28,127	1,452,909	36,699	135,675	0	130,711
1973	1,243,941	4,142,935	1,777,260	49,949	1,827,209	36,207	146,739	0	161,838
1974	1,343,972	4,369,772	2,298,091	16,259	2,314,350	30,525	90,404	0	115,571
1975	1,537,862	5,090,233	2,403,430	35,193	2,438,623	40,588	122,584	0	137,684
1976	1,727,428	5,001,677	2,776,194	126,653	2,902,847	118,610	201,215	0	182,927
1977	1,961,081	6,065,390	3,845,464	83,936	3,929,400	93,565	226,906	0	180,884
1978	1,922,950	5,738,596	2,954,313	42,637	2,996,950	91,815	200,759	0	215,673
1979	1,798,566	5,960,033	3,539,402	45,997	3,585,399	99,670	307,386	0	261,205
1980	2,231,456	7,463,378	4,749,245	54,806	4,804,051	116,487	446,175	0	290,719
1981	2,762,773	7,646,858	5,485,957	64,886	5,550,843	316,590	585,003	0	325,112
1982	2,961,383	8,475,944	6,349,080	55,997	6,405,077	447,739	638,615	0	275,763
1983	4,302,165	11,303,322	14,153,033	96,397	14,249,430	345,229	564,698	0	368,139
1984	5,077,824	14,043,628	18,448,383	77,201	18,525,584	267,497	563,588	0	413,443
1985	5,683,454	14,964,899	18,134,698	137,928	18,272,626	298,932	475,028	0	450,444
1986	5,780,666	16,593,102	19,297,129	109,938	19,407,067	703,413	350,906	0	347,690
1987	5,636,043	17,063,245	17,398,908	98,355	17,497,263	1,261,056	558,996	0	818,475
1988	5,150,238	15,704,893	17,697,838	138,405	17,836,243	1,242,139	560,911	0	585,014
1989	5,458,633	16,336,263	17,641,151	88,488	17,729,639	1,049,615	283,065	0	366,590
1990	6,440,643	18,959,051	19,995,760	99,868	20,095,628	1,298,537	229,083	0	469,502
1991	5,805,189	18,565,503	19,903,346	131,558	20,034,904	1,432,360	665,443	0	1,025,089
1992	6,471,964	19,838,439	18,194,788	279,610	18,474,398	1,167,898	738,238	0	666,181
1993	7,583,165	23,092,943	19,051,939	199,640	19,251,579	1,868,745	606,763	0	1,232,409
1994	7,142,378	19,069,838	17,354,702	204,963	17,559,665	1,699,479	763,493	0	1,145,700
1995	6,540,575	19,680,665	19,360,033	191,516	19,551,549	1,284,146	614,314	0	1,941,939
1996	7,065,052	20,408,184	19,041,451	237,846	19,279,297	1,163,708	576,674	0	1,335,804
1997	7,387,904	21,710,020	19,724,881	176,120	19,901,001	1,330,450	730,628	0	1,401,562
1998	7,530,927	20,885,007	23,227,152	182,754	23,409,906	1,513,656	309,052	0	7,568,901
1999	8,717,679	22,580,702	19,690,120	152,644	19,842,764	3,104,013	632,659	0	5,313,388
2000	12,484,909	28,278,532	23,258,426	245,010	23,503,436	1,876,491	740,777	0	1,382,646
2001	15,785,706	30,836,893	24,056,649	618,258	24,674,907	2,440,376	2,549,692	0	1,843,160
2002	11,475,179	28,350,187	20,789,485	472,793	21,262,278	1,405,443	800,065	0	758,244
2003	11,510,629	28,637,448	20,858,132	283,196	21,141,328	3,734,791	673,419	0	707,540
2004	14,644,290	33,620,379	26,619,990	244,908	26,864,898	1,819,685	1,349,413	0	1,303,773
2005	13,897,911	29,041,416	16,531,418	1,498,315	18,029,733	5,650,827	1,487,195	0	1,530,171
2006	14,046,774	30,917,220	14,974,091	247,441	15,221,532	4,217,154	642,005	0	684,170
2007	8,171,327	29,632,635	14,661,392	989,816	15,651,208	3,992,040	759,305	0	993,668
2008	16,011,634	39,981,637	19,878,279	742,645	20,620,924	5,274,824	1,079,670	0	1,745,752
2009	18,700,426	42,110,861	20,649,597	776,497	21,426,094	5,518,178	1,116,913	0	1,824,492
2010	14,468,114	35,475,659	22,817,545	814,702	23,632,247	5,778,093	1,155,771	0	1,886,001
2011	9,931,836	33,157,088	28,136,787	413,638	28,550,425	2,378,153	1,275,329	0	1,915,004
2012	9,934,247	33,165,155	28,142,128	413,737	28,555,865	2,378,806	1,276,974	0	1,916,229
2013	9,940,826	33,187,188	28,150,708	414,019	28,564,727	2,380,880	1,286,329	0	1,922,294
2014	9,944,512	33,199,641	28,145,555	414,181	28,559,736	2,382,526	1,299,807	0	1,930,319
2015	9,952,005	33,224,653	28,167,229	414,490	28,581,719	2,384,302	1,300,483	0	1,931,611
2016	9,939,254	33,182,008	28,134,922	413,959	28,548,881	2,381,062	1,295,765	0	1,927,426
2017	9,944,424	33,199,298	28,147,073	414,177	28,561,250	2,382,430	1,298,565	0	1,929,630
2018	9,952,135	33,225,152	28,157,147	414,500	28,571,647	2,384,855	1,309,401	0	1,936,652
2019	9,938,710	33,180,243	28,126,230	413,942	28,540,172	2,381,294	1,301,863	0	1,930,808
2020	9,947,487	33,209,526	28,153,893	414,304	28,568,197	2,383,255	1,300,560	0	1,931,123
2021	9,952,124	33,224,954	28,172,183	414,495	28,586,678	2,384,111	1,296,833	0	1,929,586
2022	9,949,892	33,217,619	28,152,003	414,411	28,566,414	2,384,269	1,308,351	0	1,935,815
2023	9,939,974	33,184,374	28,137,904	413,989	28,551,893	2,381,195	1,295,231	0	1,927,227
2024	9,944,012	33,197,916	28,142,366	414,161	28,556,527	2,382,512	1,301,647	0	1,931,328
2025	9,954,340	33,232,401	28,173,458	414,592	28,588,050	2,384,892	1,301,326	0	1,932,384
2026	9,935,820	33,170,569	28,118,170	413,823	28,531,993	2,380,601	1,301,520	0	1,930,276
2027	9,967,894	33,277,664	28,213,183	415,153	28,628,336	2,388,073	1,301,952	0	1,934,367
2028	9,934,943	33,167,650	28,112,829	413,787	28,526,616	2,380,521	1,303,678	0	1,931,377
2029	9,948,011	33,211,244	28,157,754	414,326	28,572,080	2,383,272	1,298,760	0	1,930,187
2030	9,938,317	33,178,832	28,133,995	413,919	28,547,914	2,380,766	1,294,414	0	1,926,570
2031	9,971,202	33,288,781	28,213,379	415,296	28,628,675	2,389,319	1,310,154	0	1,939,391
2032	9,929,334	33,148,942	28,096,162	413,553	28,509,715	2,379,219	1,303,599	0	1,930,654
2033	9,949,117	33,214,890	28,166,158	414,367	28,580,525	2,383,276	1,294,491	0	1,927,916
2034	9,951,160	33,221,791	28,163,147	414,458	28,577,605	2,384,194	1,302,070	0	1,932,423
2035	9,930,717	33,153,555	28,100,634	413,613	28,514,247	2,379,537	1,303,568	0	1,930,821
TOTAL	528,202,278	1,565,064,460	1,284,731,992	20,496,142	1,305,228,134	123,730,589	57,141,895	0	90,629,392

**TABLE B-11. Minimum OMP&R Costs of Each Aqueduct Reach to Be Reimbursed through Minimum OMP&R Component of Transportation Charge**

(in dollars)

Sheet 6 of 9

Calendar Year	CALIFORNIA AQUEDUCT (continued)									
	MOJAVE DIVISION (continued)							SANTA ANA DIVISION		
	Reach 20B	Reach 21	Reach 22A	Reach 22B	Reach 23	Reach 24	Subtotal	Reach 25	Reach 26A	
	[47]	[48]	[49]	[50]	[51]	[52]	[53]	[54]	[55]	
1961	0	0	0	0	0	0	0	0	0	
1962	0	0	0	0	0	0	0	0	0	
1963	0	0	0	0	0	0	0	0	0	
1964	0	0	0	0	0	0	0	0	0	
1965	0	0	0	0	0	0	0	0	0	
1966	0	0	0	0	0	0	0	0	0	
1967	0	0	0	0	0	0	0	0	0	
1968	0	0	0	0	0	0	0	0	0	
1969	0	0	0	0	0	0	0	0	0	
1970	0	0	0	0	0	0	0	0	0	
1971	0	0	0	0	0	0	0	0	0	
1972	120,271	75,768	80,436	1,036,831	51,520	362,153	2,030,064	26	578	
1973	148,631	60,641	66,539	1,283,816	65,475	353,262	2,323,148	20,541	679,328	
1974	88,200	65,007	77,667	1,477,946	96,340	334,302	2,375,962	24,380	799,400	
1975	118,898	135,462	77,825	1,630,554	111,141	419,450	2,794,186	29,337	885,021	
1976	151,555	106,314	131,007	1,598,071	107,787	304,638	2,902,124	51,356	1,103,139	
1977	112,589	98,757	86,279	1,882,080	71,228	48,359	2,800,647	62,584	1,412,740	
1978	120,584	109,271	71,763	2,211,965	72,179	637,401	3,731,410	67,186	1,159,950	
1979	194,104	203,078	121,586	2,104,832	76,960	202,566	3,571,387	84,462	1,235,189	
1980	237,250	156,794	117,274	2,670,387	147,009	688,605	4,870,700	72,651	1,532,535	
1981	292,081	181,062	119,602	3,030,407	134,895	47,750	5,032,502	35,662	1,575,444	
1982	330,502	186,109	125,429	3,248,883	299,712	623,755	6,176,507	28,852	1,822,250	
1983	326,767	219,943	140,523	3,899,769	223,626	384,292	6,472,986	19,017	1,663,599	
1984	329,933	266,919	146,866	4,783,997	59,337	1,104,149	6,935,729	11,319	2,325,661	
1985	388,327	799,514	125,780	5,330,501	261,135	811,346	8,941,007	17,764	2,707,662	
1986	315,566	242,158	178,847	6,190,812	156,053	515,945	9,001,390	31,012	2,768,728	
1987	357,971	298,190	236,263	5,731,239	151,796	732,607	10,146,593	19,362	2,847,390	
1988	400,005	331,099	149,876	6,910,472	253,833	970,052	11,403,401	36,576	3,087,873	
1989	345,614	194,047	138,825	5,963,386	349,544	1,242,144	9,932,830	30,881	3,190,809	
1990	202,412	273,748	49,174	6,905,442	436,785	1,891,053	11,755,736	25,518	3,330,913	
1991	516,257	478,555	231,223	7,488,366	263,723	1,561,051	13,662,067	32,172	3,847,589	
1992	696,623	585,072	168,251	7,076,997	317,042	622,116	12,038,418	55,819	4,043,878	
1993	818,675	509,309	207,818	7,765,751	359,632	1,708,915	15,078,017	72,464	5,638,325	
1994	957,350	873,215	241,679	7,691,548	1,220,795	1,245,936	15,839,195	105,373	5,139,991	
1995	2,411,412	355,198	179,930	6,994,639	842,041	746,371	15,369,990	96,781	4,357,648	
1996	1,713,145	790,618	136,397	8,590,347	889,842	(78,782)	15,117,753	156,395	4,051,744	
1997	2,043,179	640,177	189,241	8,138,580	1,586,227	3,355,446	19,415,490	177,217	4,585,198	
1998	508,030	297,621	115,100	8,887,728	1,924,868	1,134,837	22,259,793	142,703	4,866,225	
1999	1,583,887	1,344,804	158,127	9,548,762	2,027,154	1,340,712	25,053,506	189,880	5,957,072	
2000	1,437,269	974,362	165,942	9,541,048	1,711,994	1,520,219	19,350,748	353,640	4,203,640	
2001	1,526,739	1,071,309	476,330	7,684,613	1,893,231	25,579	19,511,029	298,329	2,435,173	
2002	583,717	1,157,056	291,096	11,281,918	1,684,767	946,719	18,909,025	509,094	3,423,421	
2003	621,363	467,741	278,116	13,346,098	2,096,392	(411,897)	21,513,563	368,565	3,753,401	
2004	1,025,345	1,043,564	404,058	10,581,130	2,128,942	1,106,945	20,762,855	427,842	5,460,064	
2005	867,731	670,878	347,544	7,735,531	2,415,710	2,214,193	22,919,780	452,745	5,645,457	
2006	2,391,350	657,567	518,416	11,994,557	1,927,690	1,436,887	24,469,796	396,666	5,626,331	
2007	1,485,376	861,535	450,442	12,201,494	3,184,249	1,949,871	25,877,980	436,469	7,833,299	
2008	1,609,241	690,823	437,020	13,872,516	2,703,496	2,094,948	29,508,290	450,129	7,284,552	
2009	1,675,721	718,427	453,635	15,070,397	2,832,627	2,346,476	31,556,866	470,647	8,605,205	
2010	1,745,693	746,724	471,092	15,363,706	2,956,578	2,415,991	32,519,649	493,803	8,717,092	
2011	1,123,609	844,266	465,675	10,076,559	545,657	2,698,660	21,322,912	82,759	7,369,775	
2012	1,124,713	844,919	466,160	10,081,937	545,979	2,304,705	20,940,422	82,771	7,371,217	
2013	1,130,737	848,333	468,826	10,107,421	547,624	1,214,716	19,907,160	82,775	7,373,735	
2014	1,139,220	853,008	472,610	10,139,984	549,816	3,178,453	21,945,743	82,726	7,372,812	
2015	1,139,893	853,555	472,883	10,146,921	550,168	1,207,912	19,987,728	82,791	7,378,475	
2016	1,136,541	851,438	471,431	10,127,115	548,979	3,464,754	22,204,511	82,704	7,369,908	
2017	1,138,453	852,597	472,267	10,137,079	549,581	2,023,484	20,784,086	82,736	7,373,159	
2018	1,145,430	856,554	475,358	10,166,717	551,508	2,384,619	21,211,094	82,740	7,376,118	
2019	1,140,308	853,465	473,120	10,140,163	549,860	3,446,061	22,216,942	82,666	7,367,825	
2020	1,139,788	853,392	472,855	10,143,712	549,982	2,107,799	20,882,466	82,751	7,374,996	
2021	1,137,635	852,339	471,875	10,138,842	549,580	936,615	19,697,416	82,815	7,379,645	
2022	1,144,712	856,114	475,043	10,162,666	551,225	2,203,614	21,021,809	82,726	7,374,737	
2023	1,136,239	851,296	471,295	10,126,395	548,892	3,403,765	22,141,535	82,715	7,370,662	
2024	1,140,352	853,616	473,119	10,143,531	550,004	2,016,481	20,792,590	82,714	7,372,021	
2025	1,140,499	853,936	473,144	10,150,415	550,343	2,242,781	21,029,720	82,810	7,380,116	
2026	1,140,001	853,234	472,995	10,137,244	549,679	3,528,148	22,293,698	82,642	7,365,709	
2027	1,141,340	854,720	473,474	10,161,710	550,920	1,817,108	20,623,664	82,929	7,390,486	
2028	1,141,311	853,917	473,581	10,141,407	549,993	976,343	19,752,128	82,620	7,364,390	
2029	1,138,699	852,817	472,361	10,140,085	549,710	3,330,791	22,096,682	82,767	7,375,943	
2030	1,135,676	850,954	471,046	10,123,359	548,700	3,464,679	22,196,164	82,705	7,369,617	
2031	1,146,540	857,608	475,784	10,182,262	552,272	272,730	19,126,059	82,910	7,390,786	
2032	1,141,072	853,655	473,493	10,137,141	549,784	3,300,642	22,069,259	82,569	7,360,044	
2033	1,136,084	851,430	471,190	10,131,423	549,095	1,738,271	20,483,176	82,806	7,378,000	
2034	1,140,855	854,060	473,318	10,149,712	550,331	1,490,445	20,277,408	82,776	7,377,450	
2035	1,141,104	853,710	473,503	10,138,014	549,790	5,097,318	23,867,365	82,583	7,361,201	
TOTAL	59,260,174	40,253,369	19,959,424	522,178,930	51,842,827	98,807,256	1,063,803,856	8,421,725	323,932,341	

**TABLE B-11. Minimum OMP&R Costs of Each Aqueduct Reach to Be Reimbursed through Minimum OMP&R Component of Transportation Charge**

(in dollars)

Sheet 7 of 9

Calendar Year	CALIFORNIA AQUEDUCT (continued)									
	SANTA ANA DIVISION (continued)				SANTA ANA DIVISION - EAST BRANCH EXTENSION					
	Reach 28G	Reach 28H	Reach 28J	Subtotal	Reach 1	Reach 2A	Reach 2B	Reach 2C	Reach 2D	
[56]	[57]	[58]	[59]	[60]	[61]	[62]	[63]	[64]		
1961	0	0	0	0	0	0	0	0	0	
1962	0	0	0	0	0	0	0	0	0	
1963	0	0	0	0	0	0	0	0	0	
1964	0	0	0	0	0	0	0	0	0	
1965	0	0	0	0	0	0	0	0	0	
1966	0	0	0	0	0	0	0	0	0	
1967	0	0	0	0	0	0	0	0	0	
1968	0	0	0	0	0	0	0	0	0	
1969	0	0	0	0	0	0	0	0	0	
1970	0	0	0	0	0	0	0	0	0	
1971	0	0	0	0	0	0	0	0	0	
1972	109	30	0	743	0	0	0	0	0	
1973	136,352	79	0	836,300	0	0	0	0	0	
1974	155,262	34,693	854,637	1,868,372	0	0	0	0	0	
1975	110,729	69,082	723,814	1,817,983	0	0	0	0	0	
1976	138,575	100,400	635,853	2,029,323	0	0	0	0	0	
1977	127,543	92,647	825,880	2,521,394	0	0	0	0	0	
1978	166,919	68,363	835,082	2,297,500	0	0	0	0	0	
1979	142,586	92,812	265,525	1,820,574	0	0	0	0	0	
1980	158,340	129,897	1,120,131	3,013,554	0	0	0	0	0	
1981	160,053	111,722	333,550	2,216,431	0	0	0	0	0	
1982	205,350	135,463	1,518,759	3,708,674	0	0	0	0	0	
1983	244,720	124,651	412,806	2,484,793	0	0	0	0	0	
1984	240,496	190,924	769,068	3,537,468	0	0	0	0	0	
1985	451,600	182,242	871,492	4,230,760	0	0	0	0	0	
1986	439,048	256,526	982,332	4,477,646	0	0	0	0	0	
1987	278,094	218,717	1,118,529	4,482,092	0	0	0	0	0	
1988	271,868	200,811	1,176,659	4,773,787	0	0	0	0	0	
1989	230,953	281,861	1,130,035	4,864,539	0	0	0	0	0	
1990	437,812	308,144	1,538,449	5,640,836	0	0	0	0	0	
1991	843,388	632,912	1,630,321	6,986,382	0	0	0	0	0	
1992	281,864	5,636,464	1,102,519	11,120,544	0	0	0	0	0	
1993	382,195	570,563	994,721	7,658,268	0	0	0	0	0	
1994	617,136	415,603	1,022,412	7,300,515	0	0	0	0	0	
1995	1,308,828	704,154	894,338	7,361,749	0	0	0	0	0	
1996	1,001,063	1,041,697	1,316,493	7,567,392	0	0	0	0	0	
1997	493,841	949,188	953,590	7,159,034	0	0	0	0	0	
1998	379,997	991,426	(67,444)	6,302,907	0	0	0	0	0	
1999	493,493	1,964,137	845,343	9,449,925	0	0	0	0	0	
2000	844,558	1,004,569	1,130,423	7,536,830	0	0	0	0	0	
2001	1,668,195	811,163	5,688,912	10,901,772	0	0	0	0	0	
2002	1,252,893	424,389	2,197,952	7,807,749	0	0	0	0	0	
2003	546,192	376,265	1,279,384	6,323,807	0	728	372,802	117	0	
2004	1,239,635	440,811	3,465,088	11,033,440	12,139	2,882	505,956	330	0	
2005	1,519,906	684,733	(1,749,483)	6,553,358	8,599	1,747	523,395	1,445	0	
2006	651,595	320,174	4,173,183	11,167,949	8,006	3,028	518,624	7,763	1,593	
2007	854,970	661,978	2,502,314	12,289,030	170,284	6,339	1,135,013	6,858	3,367	
2008	1,031,309	699,504	5,960,637	15,426,131	10,441	2,812	567,778	4,924	1,651	
2009	1,078,318	731,389	4,273,735	15,159,294	10,917	2,940	593,658	5,148	1,727	
2010	1,131,373	767,375	4,422,129	15,531,772	11,454	3,085	622,867	5,401	1,811	
2011	768,293	535,749	2,323,303	11,079,879	11,454	3,085	622,867	5,401	1,811	
2012	768,411	535,829	2,543,034	11,301,262	11,454	3,085	622,867	5,401	1,811	
2013	768,449	535,856	2,862,510	11,623,325	11,454	3,085	622,867	5,401	1,811	
2014	768,003	535,544	2,397,525	11,156,610	11,454	3,085	622,867	5,401	1,811	
2015	768,605	535,965	2,701,729	11,467,565	11,454	3,085	622,867	5,401	1,811	
2016	767,796	535,402	2,317,328	11,073,138	11,454	3,085	622,867	5,401	1,811	
2017	768,082	535,599	3,052,368	11,811,944	11,454	3,085	622,867	5,401	1,811	
2018	768,124	535,631	2,472,574	11,235,187	11,454	3,085	622,867	5,401	1,811	
2019	767,420	535,139	3,077,613	11,830,663	11,454	3,085	622,867	5,401	1,811	
2020	768,232	535,705	2,170,093	10,931,777	11,454	3,085	622,867	5,401	1,811	
2021	768,832	536,122	2,548,237	11,315,651	11,454	3,085	622,867	5,401	1,811	
2022	768,010	535,550	3,539,707	12,300,730	11,454	3,085	622,867	5,401	1,811	
2023	767,898	535,471	2,477,950	11,234,696	11,454	3,085	622,867	5,401	1,811	
2024	767,882	535,463	2,862,894	11,620,974	11,454	3,085	622,867	5,401	1,811	
2025	768,767	536,078	2,083,091	10,850,862	11,454	3,085	622,867	5,401	1,811	
2026	767,204	534,987	3,444,124	12,194,666	11,454	3,085	622,867	5,401	1,811	
2027	769,878	536,853	1,758,638	10,538,784	11,454	3,085	622,867	5,401	1,811	
2028	767,002	534,847	2,765,561	11,514,420	11,454	3,085	622,867	5,401	1,811	
2029	768,381	535,808	2,612,268	11,375,167	11,454	3,085	622,867	5,401	1,811	
2030	767,807	535,408	2,691,046	11,446,583	11,454	3,085	622,867	5,401	1,811	
2031	769,705	536,732	3,589,983	12,370,116	11,454	3,085	622,867	5,401	1,811	
2032	766,532	534,520	1,975,656	10,719,321	11,454	3,085	622,867	5,401	1,811	
2033	768,715	536,041	2,906,973	11,672,535	11,454	3,085	622,867	5,401	1,811	
2034	768,460	535,864	2,634,154	11,398,704	11,454	3,085	622,867	5,401	1,811	
2035	766,665	534,612	3,493,270	12,238,331	11,454	3,085	622,867	5,401	1,811	
TOTAL	40,920,311	35,818,333	124,450,797	533,543,507	518,190	100,686	20,411,768	167,011	55,424	

**TABLE B-11. Minimum OMP&R Costs of Each Aqueduct Reach to Be Reimbursed through Minimum OMP&R Component of Transportation Charge**

(in dollars)

Sheet 8 of 9

Calendar Year	CALIFORNIA AQUEDUCT (continued)										
	SANTA ANA DIVISION - EAST BRANCH EXTENSION (continued)						WEST BRANCH				
	Reach 2E	Reach 3A	Reach 3B	Reach 4A	Reach 4B	Subtotal	Reach 29A	Reach 29F	Reach 29G	Reach 29H	
	[65]	[66]	[67]	[68]	[69]	[70]	[71]	[72]	[73]	[74]	
1961	0	0	0	0	0	0	0	0	0	0	
1962	0	0	0	0	0	0	0	0	0	0	
1963	0	0	0	0	0	0	0	0	0	0	
1964	0	0	0	0	0	0	0	0	0	0	
1965	0	0	0	0	0	0	0	0	0	0	
1966	0	0	0	0	0	0	0	0	0	0	
1967	0	0	0	0	0	0	0	0	0	0	
1968	0	0	0	0	0	0	0	0	0	0	
1969	0	0	0	0	0	0	0	0	0	0	
1970	0	0	0	0	0	0	0	0	0	0	
1971	0	0	0	0	0	0	0	0	0	0	
1972	0	0	0	0	0	0	719,255	159,249	199,145	234,196	
1973	0	0	0	0	0	0	779,949	339,363	122,664	264,850	
1974	0	0	0	0	0	0	883,312	158,366	112,458	350,160	
1975	0	0	0	0	0	0	1,049,990	176,676	194,724	801,457	
1976	0	0	0	0	0	0	1,220,429	215,588	202,591	624,614	
1977	0	0	0	0	0	0	1,268,813	116,939	218,129	684,679	
1978	0	0	0	0	0	0	1,174,708	342,479	267,308	415,641	
1979	0	0	0	0	0	0	1,366,942	285,575	284,188	972,584	
1980	0	0	0	0	0	0	1,698,215	224,472	455,619	874,259	
1981	0	0	0	0	0	0	1,783,405	123,264	615,047	2,305,110	
1982	0	0	0	0	0	0	1,919,979	190,500	702,265	2,208,264	
1983	0	0	0	0	0	0	2,739,814	149,333	888,475	745,939	
1984	0	0	0	0	0	0	3,463,038	81,260	2,358,495	537,207	
1985	0	0	0	0	0	0	3,866,946	295,836	3,047,591	975,729	
1986	0	0	0	0	0	0	3,791,427	457,604	2,893,171	1,480,015	
1987	0	0	0	0	0	0	3,423,494	213,106	2,933,342	944,604	
1988	0	0	0	0	0	0	3,447,403	255,113	3,017,463	883,714	
1989	0	0	0	0	0	0	4,025,641	405,583	2,738,143	1,398,165	
1990	0	0	0	0	0	0	4,088,481	383,655	3,232,445	3,153,869	
1991	0	0	0	0	0	0	3,862,056	304,143	3,550,063	639,527	
1992	0	0	0	0	0	0	4,286,050	327,802	3,892,480	1,014,551	
1993	0	0	0	0	0	0	3,969,075	343,304	4,515,385	1,670,952	
1994	0	0	0	0	0	0	3,649,861	293,376	3,359,381	1,879,417	
1995	0	0	0	0	0	0	4,137,046	883,315	4,750,275	1,588,080	
1996	0	0	0	0	0	0	4,511,858	966,044	3,593,671	4,208,195	
1997	0	0	0	0	0	0	4,543,506	1,030,809	2,429,066	3,755,901	
1998	0	0	0	0	0	0	4,871,761	464,376	3,473,405	2,398,630	
1999	0	0	0	0	0	0	4,768,390	4,338,174	4,924,176	1,391,028	
2000	0	0	0	0	0	0	5,460,691	782,887	4,277,874	2,361,194	
2001	0	0	0	0	0	0	5,908,798	1,533,322	5,137,414	4,393,983	
2002	0	0	0	0	0	0	5,341,880	1,480,328	4,082,857	4,442,291	
2003	0	460,230	360	355	33,614	868,206	4,461,372	1,294,437	3,728,632	3,336,304	
2004	300	257,753	337	5,058	71,164	855,919	8,918,901	1,346,046	3,491,206	5,059,781	
2005	0	481,988	9,036	8,353	216,418	1,250,961	5,793,476	2,573,701	9,044,275	(471,235)	
2006	0	376,467	322	2,354	63,588	981,745	6,797,081	1,246,018	5,130,725	2,935,588	
2007	0	686,985	79,406	32,883	180,084	2,301,219	6,517,410	1,301,999	11,262,770	4,441,682	
2008	0	474,325	19,689	10,864	138,021	1,230,505	6,993,593	1,179,402	8,826,590	4,140,598	
2009	0	495,946	20,587	11,360	144,312	1,286,595	7,353,172	1,218,786	10,588,316	4,461,460	
2010	0	520,348	21,600	11,918	151,412	1,349,896	7,755,002	1,263,233	10,943,343	4,636,586	
2011	0	520,348	21,600	11,918	151,412	1,349,896	7,444,294	799,043	3,632,928	4,412,510	
2012	0	520,348	21,600	11,918	151,412	1,349,896	7,445,723	800,645	3,633,924	4,418,109	
2013	0	520,348	21,600	11,918	151,412	1,349,896	7,448,078	810,674	3,637,117	4,452,554	
2014	0	520,348	21,600	11,918	151,412	1,349,896	7,446,849	825,690	3,639,691	4,503,083	
2015	0	520,348	21,600	11,918	151,412	1,349,896	7,452,579	825,868	3,642,393	4,504,955	
2016	0	520,348	21,600	11,918	151,412	1,349,896	7,443,998	821,283	3,637,426	4,487,324	
2017	0	520,348	21,600	11,918	151,412	1,349,896	7,447,242	824,059	3,639,510	4,497,431	
2018	0	520,348	21,600	11,918	151,412	1,349,896	7,450,005	835,807	3,643,256	4,537,628	
2019	0	520,348	21,600	11,918	151,412	1,349,896	7,441,770	828,044	3,637,781	4,509,258	
2020	0	520,348	21,600	11,918	151,412	1,349,896	7,449,064	826,098	3,640,767	4,503,908	
2021	0	520,348	21,600	11,918	151,412	1,349,896	7,453,859	821,603	3,642,059	4,489,919	
2022	0	520,348	21,600	11,918	151,412	1,349,896	7,448,639	834,499	3,642,327	4,532,452	
2023	0	520,348	21,600	11,918	151,412	1,349,896	7,444,787	820,505	3,637,602	4,484,345	
2024	0	520,348	21,600	11,918	151,412	1,349,896	7,446,030	827,418	3,639,627	4,507,989	
2025	0	520,348	21,600	11,918	151,412	1,349,896	7,454,239	826,495	3,643,258	4,506,271	
2026	0	520,348	21,600	11,918	151,412	1,349,896	7,439,639	827,710	3,636,707	4,507,395	
2027	0	520,348	21,600	11,918	151,412	1,349,896	7,464,734	826,283	3,648,126	4,507,833	
2028	0	520,348	21,600	11,918	151,412	1,349,896	7,438,248	830,363	3,636,617	4,516,715	
2029	0	520,348	21,600	11,918	151,412	1,349,896	7,450,062	823,889	3,640,767	4,496,318	
2030	0	520,348	21,600	11,918	151,412	1,349,896	7,443,750	819,637	3,636,935	4,481,141	
2031	0	520,348	21,600	11,918	151,412	1,349,896	7,464,861	835,215	3,650,053	4,538,305	
2032	0	520,348	21,600	11,918	151,412	1,349,896	7,433,849	830,660	3,634,626	4,516,745	
2033	0	520,348	21,600	11,918	151,412	1,349,896	7,452,239	819,000	3,640,756	4,480,419	
2034	0	520,348	21,600	11,918	151,412	1,349,896	7,451,522	827,477	3,642,203	4,509,482	
2035	0	520,348	21,600	11,918	151,412	1,349,896	7,435,025	830,216	3,635,080	4,514,708	
TOTAL	300	16,762,722	691,337	381,095	4,783,913	43,872,446	338,803,305	49,343,644	226,476,703	190,556,366	

a) Includes certain costs to be assigned directly to Kern County Water Agency. Refer to Appendix B text discussion of Table B-16A under "Project Water Charges."

**TABLE B-11. Minimum OMP&R Costs of Each Aqueduct Reach to Be Reimbursed through Minimum OMP&R Component of Transportation Charge**

(in dollars)

Sheet 9 of 9

Calendar Year	CALIFORNIA AQUEDUCT (continued)										GRAND TOTAL	
	WEST BRANCH (cont.)			COASTAL BRANCH						Total		
	Reach 29J	Reach 30	Subtotal	Reach 31A (a)	Reach 33A	Reach 33B	Reach 34	Reach 35	Subtotal			
[75]	[76]	[77]	[78]	[79]	[80]	[81]	[82]	[83]	[84]	[85]		
1961	0	0	0	0	0	0	0	0	0	0	0	0
1962	0	0	0	0	0	0	0	0	0	0	0	42,918
1963	0	0	0	0	0	0	0	0	0	0	0	168,358
1964	0	0	0	0	0	0	0	0	0	0	0	184,729
1965	0	0	0	0	0	0	0	0	0	0	0	378,874
1966	0	0	0	0	0	0	0	0	0	0	0	408,397
1967	0	0	0	0	0	0	0	0	0	0	0	634,505
1968	0	0	0	0	0	0	0	0	0	0	2,160,548	2,745,160
1969	0	0	0	509,728	0	0	0	0	0	509,728	3,324,718	4,074,939
1970	0	0	0	609,988	0	0	0	0	0	609,988	3,983,062	4,676,282
1971	0	0	0	699,052	0	0	0	0	0	699,052	5,614,013	6,185,714
1972	88,198	420,789	1,820,832	697,576	0	0	0	0	0	697,576	12,353,356	12,998,869
1973	119,743	621,431	2,248,000	641,626	0	0	0	0	0	641,626	14,590,688	15,194,233
1974	(4,525)	723,949	2,223,720	669,279	0	0	0	0	0	669,279	16,598,762	17,372,561
1975	75,870	841,991	3,140,708	806,429	0	0	0	0	0	806,429	19,569,999	20,517,423
1976	98,268	(650,944)	1,710,546	840,927	0	0	0	0	0	840,927	19,002,859	20,027,213
1977	184	634,581	2,923,325	872,169	0	0	0	0	0	872,169	23,267,885	24,213,489
1978	17,764	3,088,954	5,306,854	934,119	0	0	0	0	0	934,119	24,818,739	26,012,786
1979	29,850	958,068	3,897,207	871,688	0	0	0	0	0	871,688	23,421,881	24,675,598
1980	288,303	222,549	3,763,417	1,047,396	4,790	0	0	30	75	1,052,291	30,105,348	32,038,398
1981	8,794	1,093,897	5,929,517	1,037,469	4,790	0	30	75	0	1,042,364	33,884,524	35,516,366
1982	414,230	978,624	6,413,862	1,015,555	4,790	0	30	75	0	1,020,450	39,515,188	41,611,655
1983	579,882	3,698,681	8,802,124	1,146,269	4,957	0	30	77	0	1,151,333	54,543,263	56,802,781
1984	719,282	755,136	7,914,418	1,427,192	5,051	0	31	78	0	1,432,352	63,947,633	67,105,188
1985	614,735	1,753,355	10,554,192	1,489,827	5,051	0	31	78	0	1,854,987	69,700,009	73,272,898
1986	1,032,216	1,338,657	10,993,090	1,714,723	5,051	0	31	78	0	1,719,883	73,437,761	76,707,917
1987	459,398	1,406,519	9,380,463	1,689,141	4,324	0	26	67	0	1,693,558	71,443,424	75,217,576
1988	446,468	1,452,589	9,502,750	1,964,428	4,509	0	28	70	0	1,969,035	72,349,117	76,060,618
1989	865,738	1,505,029	10,938,299	1,768,942	4,509	0	28	70	0	1,773,549	73,894,076	78,662,348
1990	777,713	847,500	12,483,663	2,274,772	0	0	28	0	0	2,274,772	86,130,115	91,361,385
1991	763,037	1,191,090	10,309,916	2,187,841	0	0	0	0	0	2,187,841	86,877,284	90,982,870
1992	872,953	2,259,032	12,652,868	2,465,364	0	0	0	0	0	2,465,364	94,167,321	99,235,524
1993	852,208	1,157,876	12,508,800	2,811,441	0	0	0	0	0	2,811,441	100,019,568	107,299,130
1994	872,624	1,674,576	11,729,235	3,894,639	0	0	0	0	0	3,894,639	92,336,811	99,944,106
1995	754,904	(421,879)	11,691,741	3,481,049	0	0	0	0	0	3,481,049	98,887,435	105,659,504
1996	877,111	1,574,098	15,730,977	5,144,684	0	0	0	0	0	5,144,684	105,119,193	112,018,784
1997	1,597,361	1,521,491	14,878,134	2,523,741	(33)	0	0	0	0	2,523,708	107,647,058	113,385,326
1998	1,996,114	1,291,185	14,495,471	4,302,712	1,878,365	1,386	160,400	88,026	0	6,430,889	120,649,996	127,316,519
1999	1,000,370	2,059,968	18,482,106	4,186,890	1,950,758	16,646	184,325	87,373	0	6,425,992	124,753,820	133,895,183
2000	171,261	1,529,054	14,582,961	2,887,384	2,533,121	20,756	253,532	109,322	0	5,804,115	122,249,124	130,905,236
2001	240,853	(942,708)	16,271,662	3,113,399	2,241,933	14,426	153,879	58,875	0	5,582,512	135,962,968	143,315,101
2002	(51,885)	3,419,111	18,714,582	3,187,937	2,686,101	49,436	189,442	81,720	0	6,194,636	125,084,323	130,723,129
2003	(627,530)	968,853	13,162,068	3,337,953	2,777,886	44,205	200,985	85,013	0	6,446,042	125,842,062	134,763,586
2004	(615,239)	1,515,533	19,716,228	3,542,320	2,668,727	69,895	240,426	109,830	0	6,631,198	145,069,676	155,170,943
2005	2,650,136	(1,119,066)	18,471,287	3,871,513	2,983,372	120,379	292,354	137,878	0	7,405,496	127,778,123	135,907,976
2006	893,378	(441,538)	16,561,252	2,601,255	3,381,382	55,162	280,756	134,399	0	6,452,954	132,964,553	140,658,807
2007	846,203	14,346,780	38,716,844	3,526,643	4,179,107	67,553	299,035	142,366	0	8,153,904	158,612,926	168,559,605
2008	1,473,677	6,888,328	29,502,188	3,852,040	3,257,817	67,020	289,679	99,513	0	7,546,069	180,126,000	189,280,895
2009	1,540,851	3,537,101	28,699,686	4,123,250	3,597,448	70,075	281,754	103,471	0	8,175,998	191,424,310	201,497,439
2010	1,616,663	3,643,450	29,858,277	4,116,754	3,368,044	73,523	290,608	95,247	0	7,944,176	184,800,074	195,061,141
2011	877,625	3,735,845	20,902,245	4,853,655	2,350,519	73,523	2,078	5,525	0	7,285,300	149,950,572	160,661,739
2012	877,760	3,528,088	20,704,249	4,854,703	2,351,001	73,523	2,102	5,588	0	7,286,917	149,612,604	160,325,970
2013	877,804	4,020,495	21,246,722	4,857,044	2,351,973	73,523	2,257	5,999	0	7,290,796	149,498,753	160,216,481
2014	877,294	3,640,813	20,933,420	4,857,491	2,351,942	73,523	2,495	6,628	0	7,292,079	150,783,568	161,501,048
2015	877,980	3,472,095	20,775,870	4,861,190	2,353,739	73,523	2,490	6,614	0	7,292,556	149,046,932	159,772,609
2016	877,056	4,145,126	21,412,213	4,855,288	2,350,942	73,523	2,427	6,453	0	7,288,633	151,391,951	162,104,911
2017	877,382	3,931,020	21,216,644	4,857,597	2,352,021	73,523	2,466	6,555	0	7,292,162	150,560,379	161,278,239
2018	877,433	3,822,211	21,166,340	4,860,344	2,353,164	73,523	2,648	7,038	0	7,296,717	150,424,740	161,147,725
2019	876,628	4,472,124	21,765,605	4,854,399	2,350,396	73,523	2,537	6,741	0	7,287,596	152,507,068	163,217,499
2020	877,554	4,235,923	21,533,314	4,858,932	2,352,639	73,523	2,495	6,633	0	7,294,222	150,122,087	160,842,752
2021	878,240	3,287,433	20,573,113	4,861,645	2,354,037	73,523	2,419	6,427	0	7,298,051	148,404,985	159,132,048
2022	877,303	3,313,345	20,648,565	4,859,349	2,352,703	73,523	2,628	6,987	0	7,295,190	150,763,384	161,484,278
2023	877,174	3,746,309	21,010,722	4,855,718	2,351,168	73,523	2,415	6,414	0	7,289,238	151,095,886	161,809,884
2024	877,157	4,680,994	21,979,215	4,857,086	2,351,716	73,523	2,521	6,695	0	7,291,541	151,135,051	161,851,504
2025	878,166	2,556,086	19,864,485	4,862,294	2,354,269	73,523	2,495	6,633	0	7,299,214	148,581,649	159,309,742
2026	876,379	4,715,097	22,002,927	4,852,998	2,349,720	73,523	2,534	6,733	0	7,285,508	153,159,010	163,866,359
2027	879,436	44,951	17,371,363	4,869,034	2,357,556	73,523	2,477	6,585	0	7,309,175	145,493,668	156,236,739
2028	876,151	8,544,404	25,842,498	4,852,317	2,349,348	73,523	2,575	6,846	0	7,284,609	153,767,482	164,473,108
2029	877,728	2,144,129	19,432,893	4,859,395	2,352,901	73,523	2,458	6,540	0	7,294,817	149,685,084	160,406,954
2030	877,069	3,769,667	21,028,199	4,854,978	2,350,820	73,523	2,402	6,383	0	7,288,106	151,365,247	162,077,664
2031	879,237	115,131	17,482,802	4,869,853	2,357,800	73,523	2,620	6,955	0	7,310,751	145,964,541	156,708,695
2032	875,614	8,523,304	25,814,798	4,849,511	2,347,973	73,523	2,587	6,877	0	7,280,471	155,210,752	165,910,123
2033	878,106	2,515,740	19,786,260	4,860,393	2,353,470	73,523	2,378	6,322	0	7,296,086	148,734,697	159,459,186
2034	877,818	3,665,503	20,974,005	4,860,626	2,353,440	73,523	2,514	6,682	0	7,296,785	149,457,323	160,181,628
2035	875,765	4,784,310	22,075,104	4,850,232	2,348,334	73,523	2,579	6,854	0	7,281,522	154,800,947	165,501,961
TOTAL	46,293,020	162,753,803	1,014,226,841	215,693,176	96,355,441	2,447,737	3,159,067	1,497,483	319,152,904	7,159,549,953	7,635,928,828	

**TABLE B-12. Variable OMP&R Costs to Be Reimbursed through  
Variable OMP&R Component of Transportation Charge<sup>a</sup>**

(in dollars)

Sheet 1 of 4

Calendar Year	NORTH BAY AQUEDUCT				SOUTH BAY AQUEDUCT	CALIFORNIA AQUEDUCT		
	Reach 1	Reach 3A	Reach 3B	Total	Reach 1	Reach 1	Reach 4	Reach 14A
	Barker Slough Pumping Plant	Cordelia Pumping Plant (Solano)	Cordelia Pumping Plant (Napa) (b)		South Bay & Del Valle Pumping Plants (c)	Banks Pumping Plant	Dos Amigos Pumping Plant	Buena Vista Pumping Plant
[1]	[2]	[3]	[4]	[5]	[6]	[7]	[8]	
1962	0	0	0	0	36,970	0	0	0
1963	0	0	0	0	57,711	0	0	0
1964	0	0	0	0	74,134	0	0	0
1965	0	0	0	0	142,609	0	0	0
1966	0	0	0	0	192,605	0	0	0
1967	0	0	0	0	223,117	13,881	0	0
1968	0	0	6,989	6,989	336,671	452,630	202,947	0
1969	0	0	8,551	8,551	257,579	293,741	135,425	0
1970	0	0	13,598	13,598	396,358	346,215	211,197	1
1971	0	0	10,609	10,609	381,662	574,015	225,188	138,001
1972	0	0	14,434	14,434	598,702	933,292	502,196	241,714
1973	0	0	14,449	14,449	493,490	688,030	381,232	306,268
1974	0	0	17,473	17,473	565,575	783,562	447,772	358,739
1975	0	0	14,779	14,779	349,758	1,341,019	518,816	550,860
1976	0	0	20,856	20,856	571,361	1,638,453	641,115	755,747
1977	0	0	22,635	22,635	512,996	1,013,307	284,828	298,300
1978	0	0	21,692	21,692	586,355	2,339,502	607,042	732,036
1979	0	0	16,237	16,237	605,136	3,554,256	1,008,564	818,816
1980	0	0	19,945	19,945	523,369	2,083,336	1,129,152	1,051,629
1981	0	0	23,842	23,842	567,692	3,952,931	1,939,189	1,336,867
1982	0	0	12,157	12,157	605,780	3,092,031	1,363,705	1,200,226
1983	0	0	2,342	2,342	82,222	879,916	343,597	341,584
1984	0	0	4,822	4,822	271,543	1,695,568	885,941	678,307
1985	0	0	10,188	10,188	451,020	3,171,920	1,613,745	1,397,490
1986	0	0	15,501	15,501	807,984	6,601,752	2,627,407	2,405,224
1987	0	0	27,223	27,223	886,956	5,753,132	2,523,544	2,240,552
1988	17,813	0	24,020	41,833	909,300	6,280,898	2,611,297	2,562,330
1989	29,819	43,846	26,519	100,184	1,161,160	9,748,180	3,910,492	3,964,188
1990	52,210	67,109	40,775	160,094	1,834,626	10,467,177	4,501,309	5,785,069
1991	10,429	10,118	5,252	25,799	378,966	1,923,595	490,766	903,923
1992	13,319	13,070	9,406	35,795	311,251	3,211,086	1,168,304	1,255,567
1993	(11,941)	(8,753)	(5,392)	(26,086)	(158,214)	532,899	345,215	(124,821)
1994	46,538	39,910	29,105	115,553	799,370	5,658,038	2,298,300	2,510,629
1995	20,014	20,620	11,791	52,425	247,645	4,017,881	1,513,362	1,919,965
1996	57,320	47,288	23,483	128,091	718,807	8,112,547	3,969,388	2,430,979
1997	67,416	52,935	21,955	142,306	1,038,568	6,900,694	2,845,506	2,589,077
1998	(10,647)	(9,488)	(4,554)	(24,689)	(121,313)	238,073	(314,172)	(245,259)
1999	31,618	25,288	10,570	67,476	514,166	5,319,699	2,316,189	1,587,062
2000	58,651	42,587	15,094	116,332	861,671	8,025,528	3,046,708	2,966,168
2001	360,761	250,331	214,209	825,301	4,068,696	24,182,487	9,885,380	14,868,284
2002	191,948	105,385	61,953	359,286	2,258,767	17,207,932	6,949,418	8,493,564
2003	181,608	118,767	98,077	398,452	2,567,656	21,542,492	9,051,535	10,696,186
2004	246,316	136,402	105,066	487,784	2,452,187	21,375,154	9,167,252	12,084,098
2005	279,237	144,265	146,323	569,825	2,745,626	29,059,637	12,814,469	12,402,303
2006	208,754	287,013	145,028	640,795	2,690,955	25,655,625	11,136,200	11,825,610
2007	430,204	292,170	249,929	972,303	4,077,287	27,301,503	10,998,532	16,007,485
2008	483,149	470,598	410,143	1,363,890	5,887,390	41,371,070	17,740,437	21,509,016
2009	626,481	557,677	612,462	1,796,620	7,398,947	50,840,811	21,868,352	24,884,584
2010	525,542	524,977	492,079	1,542,598	5,774,302	38,755,458	16,415,205	18,678,559
2011	521,480	414,700	452,397	1,388,577	6,862,226	43,394,832	19,444,903	23,589,222
2012	540,348	428,969	478,218	1,447,535	7,089,080	42,423,344	20,784,419	25,670,970
2013	589,622	470,850	537,819	1,598,291	7,785,740	54,337,286	22,785,351	27,970,764
2014	632,756	505,673	593,302	1,731,731	8,344,762	49,163,463	24,802,656	30,582,842
2015	648,898	513,314	624,897	1,787,109	8,466,138	54,942,963	25,185,913	31,035,974
2016	661,703	518,585	652,426	1,832,714	8,549,901	63,245,061	26,109,311	32,585,809
2017	659,734	511,059	662,387	1,833,180	8,430,312	55,792,453	25,200,314	31,097,753
2018	683,878	525,913	705,794	1,915,585	8,665,129	55,874,264	26,638,937	33,356,592
2019	706,293	538,973	748,266	1,993,532	8,873,805	64,301,400	27,456,726	34,302,187
2020	677,336	509,300	724,801	1,911,437	8,402,344	57,165,837	25,924,223	32,458,173
2021	677,619	508,458	727,014	1,913,091	8,388,994	56,046,916	25,915,008	32,451,002
2022	657,561	491,896	701,131	1,850,588	8,125,859	51,944,758	25,135,665	31,539,971
2023	661,127	494,839	705,730	1,861,696	8,172,616	56,082,584	25,410,832	31,958,847
2024	684,378	514,039	735,733	1,934,150	8,477,659	61,489,663	26,265,645	32,915,484
2025	681,422	511,596	731,918	1,924,936	8,438,868	51,591,990	26,178,060	32,852,815
2026	685,907	515,300	737,707	1,938,914	8,497,708	64,050,787	26,317,603	32,958,763
2027	675,974	507,099	724,889	1,907,962	8,367,390	57,457,250	26,079,015	32,803,619
2028	680,476	510,815	730,698	1,921,989	8,426,466	58,510,481	26,049,849	32,624,068
2029	672,160	503,950	719,969	1,896,079	8,317,374	55,861,853	25,837,932	32,455,244
2030	677,360	508,244	726,678	1,912,282	8,385,574	58,195,349	25,870,595	32,370,251
2031	668,468	500,902	715,204	1,884,574	8,268,929	52,737,611	25,694,124	32,382,538
2032	681,243	511,450	731,691	1,924,384	8,436,539	57,385,736	25,897,242	32,271,037
2033	714,140	538,611	774,134	2,026,885	8,868,061	60,923,181	27,896,709	35,250,235
2034	688,904	517,775	741,574	1,948,253	8,537,036	57,052,951	26,333,099	32,879,798
2035	675,392	506,617	724,137	1,906,146	8,359,766	60,317,800	27,726,468	36,068,203
TOTAL	20,420,738	15,811,042	20,150,129	56,381,909	266,535,447	1,809,210,766	809,262,645	989,813,088

a) Excludes extra peaking costs assigned directly to contractors. Refer to Appendix B text discussion of Table B-17 under "Project Water Charges."  
 b) Costs for the period 1968 through 1987 are for an interim facility.  
 c) The relatively minor costs of Del Valle Pumping Plant have been combined with those of South Bay Pumping Plant to simplify the allocation procedures.

**TABLE B-12. Variable OMP&R Costs to Be Reimbursed through  
Variable OMP&R Component of Transportation Charge**

(in dollars)

Sheet 2 of 4

Calendar Year	CALIFORNIA AQUEDUCT (continued)						
	Reach 15A Wheeler Ridge Pumping Plant	Reach 16A Chrisman Pumping Plant	Reach 17E Edmonston Pumping Plant	Reach 18A Alamo Powerplant	Reach 22B Pearblossom Pumping Plant	Reach 23 Mojave Siphon Powerplant	Reach 24 Silverwood Lake (d)
	[9]	[10]	[11]	[12]	[13]	[14]	[15]
1962	0	0	0	0	0	0	0
1963	0	0	0	0	0	0	0
1964	0	0	0	0	0	0	0
1965	0	0	0	0	0	0	0
1966	0	0	0	0	0	0	0
1967	0	0	0	0	0	0	0
1968	0	0	0	0	0	0	0
1969	0	0	0	0	0	0	0
1970	0	0	0	0	0	0	0
1971	17,664	0	0	0	0	0	0
1972	97,004	180,602	542,625	0	25,568	0	0
1973	278,923	441,598	1,548,428	0	231,389	0	0
1974	367,266	618,864	2,164,223	0	354,093	0	0
1975	595,252	1,149,731	4,010,395	0	604,161	0	0
1976	756,175	1,561,385	5,443,936	0	932,444	0	0
1977	337,889	703,802	2,360,624	0	358,028	0	0
1978	658,404	1,186,696	4,180,131	0	1,551,015	0	0
1979	791,488	1,581,250	5,475,688	0	1,881,587	0	0
1980	1,047,495	2,102,439	7,028,235	0	1,762,063	0	0
1981	1,319,739	2,838,773	9,351,931	0	2,296,771	0	0
1982	1,213,660	2,424,920	8,352,207	0	1,498,620	0	0
1983	304,715	540,330	1,582,582	0	341,957	0	384,275
1984	602,408	1,129,131	3,448,759	0	622,123	0	0
1985	1,397,098	2,781,953	9,261,674	0	1,195,768	0	0
1986	2,432,322	4,999,949	16,956,023	(1,013,756)	2,359,599	0	0
1987	2,223,371	4,456,059	14,684,476	(1,026,193)	1,831,238	0	131,606
1988	2,560,462	5,126,229	16,819,159	(744,374)	2,375,784	0	0
1989	3,974,290	8,369,623	28,090,313	(766,443)	4,102,557	0	686,468
1990	6,019,952	13,630,073	48,369,421	(834,673)	6,504,876	0	89,075
1991	1,031,345	2,426,220	8,641,086	(269,625)	996,352	0	0
1992	1,314,358	2,642,161	8,854,347	(934,311)	1,167,670	0	156,847
1993	(102,311)	(582,580)	(2,649,876)	(56,908)	(253,503)	0	(34,870)
1994	2,516,185	5,276,189	18,302,830	(58,712)	2,572,826	0	0
1995	841,178	1,677,210	5,571,517	(1,242,189)	1,025,717	0	467,095
1996	2,231,167	4,723,600	16,483,976	(2,644,648)	2,487,165	(857,876)	1,959,474
1997	2,417,154	5,424,334	19,413,834	(2,488,338)	3,037,087	(1,680,469)	0
1998	(219,762)	(488,690)	(1,683,606)	(1,969,187)	(402,338)	(1,217,950)	(144,207)
1999	1,295,067	3,326,334	12,889,920	(2,811,928)	1,795,375	(2,482,354)	(4)
2000	3,038,567	6,993,106	25,232,756	(5,129,549)	3,969,325	(4,429,149)	(4)
2001	15,252,650	34,362,262	126,969,963	(3,298,048)	19,044,251	(3,649,034)	(3)
2002	8,803,124	19,884,738	73,074,994	(4,926,146)	10,767,871	(5,255,302)	(2)
2003	11,139,389	25,395,242	93,471,975	(3,431,664)	14,896,580	(6,760,773)	(1)
2004	12,682,850	28,967,907	106,508,265	(6,227,543)	16,646,955	(7,691,607)	0
2005	12,757,307	28,986,888	102,884,712	(6,140,331)	18,267,341	(6,778,759)	0
2006	12,221,482	27,669,314	101,493,156	(18,246,652)	18,993,458	(6,387,729)	0
2007	16,776,090	37,597,250	137,710,764	(6,494,577)	22,076,636	(7,474,378)	0
2008	24,858,385	52,532,355	187,774,679	(7,301,702)	34,587,329	(8,432,625)	0
2009	28,586,275	60,289,242	215,297,060	(7,030,080)	40,912,723	(8,455,905)	0
2010	21,460,524	45,255,945	161,539,390	(8,623,986)	29,892,040	(8,689,526)	0
2011	23,385,330	54,728,337	205,309,069	(5,476,030)	31,245,304	(11,985,066)	0
2012	25,518,167	59,812,225	224,394,413	(5,853,849)	34,595,673	(13,708,370)	3,105,998
2013	27,749,349	65,055,946	244,040,384	(5,635,689)	37,506,256	(14,366,938)	2,188,242
2014	30,336,071	71,176,979	267,030,333	(5,676,198)	40,560,765	(14,395,517)	0
2015	30,779,417	72,222,058	270,946,117	(5,682,522)	41,383,883	(14,316,484)	0
2016	32,345,415	75,962,306	285,103,709	(5,928,505)	44,255,305	(15,673,337)	4,228,307
2017	30,848,011	72,392,747	271,600,068	(5,657,887)	41,555,204	(14,286,403)	0
2018	33,143,645	77,858,323	292,262,902	(6,075,456)	46,044,029	(17,336,467)	6,569,801
2019	34,067,660	80,042,074	300,433,318	(5,770,535)	45,077,187	(14,846,837)	0
2020	32,260,168	75,781,191	284,462,372	(5,885,945)	43,757,965	(15,778,213)	0
2021	32,254,365	75,769,394	284,419,598	(5,902,327)	43,793,569	(15,853,376)	151,523
2022	31,366,207	73,680,414	276,598,181	(5,939,614)	42,233,650	(15,899,674)	3,498,893
2023	31,790,831	74,691,498	280,417,857	(6,021,247)	43,156,975	(16,423,531)	2,121,563
2024	32,716,378	76,863,332	288,534,269	(5,825,294)	43,616,009	(15,336,504)	0
2025	32,661,341	76,737,474	288,077,239	(5,936,943)	43,990,525	(16,033,322)	3,438,553
2026	32,755,851	76,954,987	288,871,937	(5,894,456)	44,388,034	(15,727,496)	0
2027	32,624,994	76,661,342	287,815,034	(5,935,376)	43,853,879	(15,925,247)	1,472,019
2028	32,425,483	76,173,985	285,939,361	(5,870,591)	43,825,904	(15,687,727)	0
2029	32,274,115	75,827,892	284,671,408	(5,901,278)	43,368,208	(15,850,575)	804,642
2030	32,170,740	75,569,449	283,660,632	(5,851,730)	43,427,949	(15,565,550)	0
2031	32,217,812	75,700,350	284,229,296	(6,026,651)	43,807,849	(17,425,034)	6,088,435
2032	32,053,673	75,281,804	282,538,485	(5,776,979)	42,560,327	(15,473,051)	0
2033	35,061,181	82,427,198	309,516,738	(6,094,136)	47,960,310	(17,947,926)	3,331,764
2034	32,663,449	76,727,653	287,985,695	(5,835,615)	43,599,190	(16,021,700)	0
2035	36,034,458	84,857,295	318,988,310	(6,177,639)	45,684,052	(17,815,475)	4,153,037
TOTAL	997,400,712	2,307,138,687	8,585,299,297	(240,344,055)	1,338,558,502	(469,923,256)	44,848,526

d) These values represent a proportionate allocation of the total variable OMP&R costs of pumping and recovery plants (Table B-3) associated with net annual withdrawal for Project Transportation Facilities. The allocation is determined annually by applying the following ratio, calculated from the data shown in Table B-6: "Reservoir Storage Changes" (withdrawals, as a positive value) conveyed through each plant, divided by "Total" annual quantity conveyed through each plant, in The costs so determined are accumulated for all upstream plants for each year, for each respective reservoir.



**TABLE B-12. Variable OMP&R Costs to Be Reimbursed through  
Variable OMP&R Component of Transportation Charge**

(in dollars)

Sheet 3 of 4

Calendar Year	CALIFORNIA AQUEDUCT (continued)						
	Reach 26A	EBX Reach 2B	EBX Reach 3A	EBX Reach 4B	Reach 28J	Reach 29A	Reach 29G
	Devil Canyon Powerplant	Greenspot Pumping Plant	Crafton Hills Pumping Plant	Cherry Valley Pumping Plant	Lake Perris (d)	Oso Pumping Plant	Warne Powerplant
[16]	[17]	[18]	[19]	[20]	[21]	[22]	
1962	0	0	0	0	0	0	0
1963	0	0	0	0	0	0	0
1964	0	0	0	0	0	0	0
1965	0	0	0	0	0	0	0
1966	0	0	0	0	0	0	0
1967	0	0	0	0	0	0	0
1968	0	0	0	0	0	0	0
1969	0	0	0	0	0	0	0
1970	0	0	0	0	0	0	0
1971	0	0	0	0	0	0	0
1972	(3,024)	0	0	0	0	102,315	0
1973	(436,768)	0	0	0	0	158,587	0
1974	(521,656)	0	0	0	0	193,311	0
1975	(1,071,023)	0	0	0	0	350,436	0
1976	(1,519,156)	0	0	0	0	362,767	0
1977	(1,175,966)	0	0	0	0	111,135	0
1978	(3,038,194)	0	0	0	0	125,183	0
1979	(3,419,581)	0	0	0	0	138,384	0
1980	(3,318,152)	0	0	0	0	236,768	0
1981	(3,842,971)	0	0	0	0	444,280	0
1982	(2,736,072)	0	0	0	0	539,245	(783,626)
1983	(5,478,830)	0	0	0	0	71,197	(495,041)
1984	(7,326,265)	0	0	0	(10,080)	240,134	(2,027,345)
1985	(10,477,567)	0	0	0	(56,570)	874,069	(5,930,176)
1986	(11,484,996)	0	0	0	0	1,269,590	(5,579,301)
1987	(10,814,483)	0	0	0	53,242	1,325,936	(6,304,539)
1988	(14,495,967)	0	0	0	0	1,421,097	(6,993,235)
1989	(18,532,961)	0	0	0	89,890	2,013,335	(8,235,085)
1990	(20,911,839)	0	0	0	147,163	2,857,409	(11,011,065)
1991	(4,884,013)	0	0	0	0	534,818	(3,600,495)
1992	(9,513,281)	0	0	0	(61,233)	717,740	(5,508,780)
1993	(7,502,549)	0	0	0	0	68,719	(4,525,955)
1994	(11,662,318)	0	0	0	147,989	1,203,006	(5,813,538)
1995	(9,742,248)	0	0	0	0	247,869	(1,934,202)
1996	(12,358,465)	0	0	0	0	895,929	(4,248,531)
1997	(13,293,791)	0	0	0	111,776	897,657	(4,797,589)
1998	(10,183,555)	0	0	0	0	(25,895)	(740,480)
1999	(14,772,635)	0	0	0	(4)	677,032	(5,526,541)
2000	(25,856,637)	0	0	0	(4)	1,216,343	(9,464,490)
2001	(19,498,071)	0	0	0	(3)	6,445,378	(7,987,833)
2002	(24,635,887)	0	0	0	(2)	3,834,216	(10,286,902)
2003	(28,000,328)	0	0	0	(1)	4,519,298	(10,281,922)
2004	(31,217,777)	0	0	0	0	5,385,468	(12,033,953)
2005	(30,592,888)	0	0	0	0	4,130,683	(8,251,156)
2006	(34,523,432)	145,736	159,676	19,624	0	3,833,868	(8,780,170)
2007	(27,812,496)	197,660	165,349	11,537	0	6,779,536	(10,607,268)
2008	(35,583,065)	544,807	675,558	140,682	0	8,498,764	(11,393,707)
2009	(34,157,283)	676,957	840,480	174,668	0	9,099,641	(9,862,386)
2010	(33,250,529)	503,949	624,568	130,175	0	7,162,909	(10,341,348)
2011	(31,890,275)	550,577	687,114	141,595	0	11,450,099	(14,650,186)
2012	(32,767,470)	550,577	687,114	141,595	3,146,088	12,482,173	(15,339,504)
2013	(32,068,590)	550,577	687,114	141,595	0	13,476,655	(15,283,505)
2014	(32,629,954)	550,577	687,114	141,595	780,212	14,845,607	(15,843,534)
2015	(33,013,046)	550,577	687,114	141,595	0	14,977,022	(15,759,992)
2016	(33,748,878)	550,577	687,114	141,595	235,610	15,542,750	(16,203,459)
2017	(33,391,072)	550,577	687,114	141,595	0	14,973,152	(15,819,348)
2018	(34,321,831)	550,577	687,114	141,595	3,731,220	15,710,502	(16,067,464)
2019	(33,900,323)	550,577	687,114	141,595	0	16,901,949	(16,937,989)
2020	(34,903,652)	550,577	687,114	141,595	3,156,924	15,680,761	(16,608,908)
2021	(34,521,662)	550,577	687,114	141,595	72,588	15,652,525	(16,601,300)
2022	(34,090,661)	550,577	687,114	141,595	0	15,415,429	(16,870,586)
2023	(34,763,245)	550,577	687,114	141,595	1,506,880	15,498,767	(16,866,257)
2024	(34,481,262)	550,577	687,114	141,595	0	16,223,363	(17,034,145)
2025	(34,075,419)	550,577	687,114	141,595	0	16,006,131	(16,881,236)
2026	(34,939,364)	550,577	687,114	141,595	714,376	15,923,663	(16,680,182)
2027	(34,444,274)	550,577	687,114	141,595	0	16,068,842	(17,093,295)
2028	(34,678,703)	550,577	687,114	141,595	984,722	15,813,440	(16,701,317)
2029	(34,419,980)	550,577	687,114	141,595	0	15,894,082	(17,002,513)
2030	(34,504,176)	550,577	687,114	141,595	0	15,703,123	(16,664,066)
2031	(34,213,751)	550,577	687,114	141,595	358,165	15,788,438	(16,888,685)
2032	(33,905,212)	550,577	687,114	141,595	0	15,846,907	(16,684,442)
2033	(35,043,969)	550,577	687,114	141,595	4,704,436	16,994,611	(16,912,490)
2034	(33,738,101)	550,577	687,114	141,595	0	16,057,051	(16,706,378)
2035	(35,698,878)	550,577	687,114	141,595	6,420,643	19,686,443	(20,894,271)
TOTAL	(1,389,800,467)	15,833,535	19,643,481	4,016,561	26,234,027	467,571,644	(608,341,711)

**TABLE B-12. Variable OMP&R Costs to Be Reimbursed through  
Variable OMP&R Component of Transportation Charge<sup>a</sup>**

(in dollars)

Sheet 4 of 4

Calendar Year	CALIFORNIA AQUEDUCT (continued)						GRAND TOTAL
	Reach 29H	Reach 29J	Reach 30	Reach 31A	Reach 33A	Total	
	Pyramid Lake (d [23]	Castaic Powerplant [24]	Castaic Lake (d [25]	Las Perillas & Badger Hill Pumping Plants [26]	Devil's Den, Bluestone & Polonio Pumping Plants [27]		
1962	0	0	0	0	0	0	36,970
1963	0	0	0	0	0	0	57,711
1964	0	0	0	0	0	0	74,134
1965	0	0	0	0	0	0	142,609
1966	0	0	0	0	0	0	192,605
1967	0	0	0	0	0	13,881	236,998
1968	0	0	0	118,676	0	774,253	1,117,913
1969	0	0	0	78,350	0	507,516	773,646
1970	0	0	0	136,429	0	693,842	1,103,798
1971	0	0	0	166,296	0	1,121,164	1,513,435
1972	0	(211,144)	0	237,638	0	2,648,786	3,261,922
1973	0	(1,057,564)	0	120,913	0	2,661,036	3,168,975
1974	0	(1,547,884)	0	118,582	0	3,336,872	3,919,920
1975	0	(2,455,461)	0	94,848	0	5,689,034	6,053,571
1976	0	(2,827,557)	0	141,260	0	7,886,569	8,478,786
1977	0	(3,734,462)	0	71,311	0	628,796	1,164,427
1978	0	(1,542,479)	0	179,925	0	6,979,261	7,587,308
1979	0	(2,773,323)	0	192,126	0	9,249,255	9,870,628
1980	0	(3,408,863)	0	168,458	0	9,882,560	10,425,874
1981	0	(2,834,322)	0	169,177	0	16,972,365	17,563,899
1982	0	(3,463,971)	0	168,390	0	12,859,335	13,477,272
1983	65,741	(3,260,764)	(3,176,515)	17,920	0	(7,537,336)	(7,452,772)
1984	0	(2,336,089)	(2,151,129)	112,679	0	(4,435,858)	(4,159,493)
1985	0	(15,698,638)	0	146,843	0	(10,322,391)	(9,861,183)
1986	0	(11,072,448)	0	297,886	0	10,799,251	11,622,736
1987	68,410	(11,562,269)	(41,897)	245,082	0	5,787,267	6,701,446
1988	54,038	(12,292,638)	(211,526)	214,519	0	5,288,073	6,239,206
1989	14,390	(14,514,469)	126,791	282,180	0	23,323,739	24,585,083
1990	0	(20,116,506)	245,180	416,832	0	46,159,453	48,154,173
1991	439,068	(6,579,194)	0	3,610	0	2,057,456	2,462,221
1992	0	(9,493,502)	(935,650)	101,665	0	(5,857,012)	(5,509,966)
1993	(13,291)	(9,266,007)	(446,527)	(111,306)	0	(24,723,671)	(24,907,971)
1994	20,518	(10,547,914)	(86,993)	206,258	0	12,537,293	13,452,216
1995	0	(4,049,615)	0	243,434	0	(443,026)	(142,956)
1996	0	(8,457,232)	0	296,170	0	15,023,643	15,870,541
1997	0	(8,727,328)	(897)	298,483	208,816	13,156,006	14,336,880
1998	(931,305)	(3,360,851)	(2,108,804)	(51,634)	(87,016)	(23,936,638)	(24,082,640)
1999	(4)	(9,954,674)	(4)	159,358	234,077	(5,948,035)	(5,366,393)
2000	(4)	(17,958,033)	(4)	231,346	380,555	(7,737,472)	(6,759,469)
2001	(3)	(13,981,232)	(3)	1,086,309	2,152,324	205,835,058	210,729,055
2002	(2)	(18,455,024)	(2)	545,459	1,320,943	87,322,990	89,941,043
2003	(1)	(17,307,974)	(1)	641,112	1,482,405	127,053,549	130,019,657
2004	0	(20,022,179)	0	661,852	1,718,113	138,004,855	140,944,826
2005	0	(13,698,272)	0	829,541	1,669,939	158,341,414	161,656,865
2006	0	(14,679,220)	0	851,191	1,529,589	132,917,326	136,249,076
2007	0	(19,258,969)	0	1,311,758	2,138,250	207,424,664	212,474,254
2008	0	(20,180,772)	0	1,784,716	4,703,180	313,829,108	321,080,388
2009	0	(17,557,263)	0	2,388,725	7,241,797	386,038,399	395,233,966
2010	0	(18,340,604)	0	1,841,333	5,606,694	268,620,755	275,937,655
2011	0	(24,875,719)	0	2,254,120	6,221,251	333,524,477	341,775,280
2012	0	(26,222,616)	2,997,738	2,325,658	6,435,339	371,179,682	379,716,297
2013	0	(26,064,151)	0	2,535,316	7,063,743	412,669,705	422,053,736
2014	0	(26,863,563)	0	2,709,893	7,586,265	445,545,606	455,622,099
2015	0	(26,707,346)	0	2,748,193	7,700,889	457,822,325	468,075,572
2016	0	(27,482,296)	1,153,942	2,774,622	7,780,001	493,644,959	504,027,574
2017	0	(26,847,105)	0	2,736,889	7,667,057	459,241,119	469,504,611
2018	0	(27,339,700)	4,943,495	2,811,358	7,889,950	507,073,386	517,654,100
2019	0	(28,942,915)	0	2,876,829	8,085,899	514,525,916	525,393,253
2020	0	(28,266,268)	0	2,728,064	7,640,646	480,952,624	491,266,405
2021	0	(28,272,254)	0	2,723,853	7,628,036	477,106,744	487,408,829
2022	0	(28,738,698)	7,223	2,640,823	7,379,529	461,280,796	471,257,243
2023	0	(28,731,507)	50,219	2,655,576	7,423,690	471,339,618	481,373,930
2024	0	(29,021,546)	1,576,015	2,751,829	7,711,769	490,344,291	500,756,100
2025	0	(28,757,749)	138,589	2,739,589	7,675,138	481,782,061	492,145,865
2026	0	(28,411,063)	0	2,758,155	7,730,713	493,151,594	503,588,216
2027	0	(29,120,047)	1,810,105	2,717,037	7,607,637	485,831,820	496,107,172
2028	0	(28,445,427)	0	2,735,675	7,663,428	482,741,917	493,090,372
2029	0	(28,967,070)	1,247,154	2,701,253	7,560,400	477,742,053	487,955,506
2030	0	(28,383,330)	0	2,722,773	7,624,813	477,726,108	488,023,964
2031	0	(28,790,500)	10,153,135	2,685,967	7,514,648	487,393,033	497,546,536
2032	0	(28,520,193)	0	2,738,854	7,672,940	475,266,414	485,627,337
2033	0	(28,977,402)	9,693,603	2,875,015	8,080,473	541,118,817	552,013,763
2034	0	(28,566,228)	0	2,770,564	7,767,851	484,348,565	494,833,854
2035	0	(35,819,961)	31,997,480	2,714,629	7,600,431	567,222,311	577,488,223
TOTAL	(282,445)	(1,085,721,364)	56,980,717	84,648,234	219,012,202	13,981,059,326	14,303,976,682

**TABLE B-13. Capital and Operating Costs of Project Conservation Facilities to Be Reimbursed through Delta Water Charge**

(in dollars)

Calendar Year	Initial Project Conservation Facilities (Portions of Upper Feather Lakes, Oroville-Thermalito and California Aqueduct Facilities)					Planning and Pre-operating Costs (a (f))	Total
	Capital Costs (a)	Capital Cost Credits (b)	Operating Costs (c)	Application of Oroville Power Revenues to:			
				Capital Costs (d)	Operating Costs (e)		
	[1]	[2]	[3]	[4]	[5]	[6]	[7]
1952	171,322	0	0	0	0	0	171,322
1953	312,190	0	0	0	0	0	312,190
1954	308,624	0	0	0	0	0	308,624
1955	194,645	0	0	0	0	0	194,645
1956	1,357,077	0	0	0	0	0	1,357,077
1957	6,210,709	0	0	0	0	0	6,210,709
1958	9,510,916	0	0	0	0	0	9,510,916
1959	11,390,586	0	0	0	0	0	11,390,586
1960	14,463,274	(4,850,000)	0	0	0	0	9,613,274
1961	18,729,965	(431,527)	0	0	0	0	18,298,438
1962	9,099,967	(479,280)	0	0	0	0	8,620,687
1963	73,098,107	(478,743)	(14,000)	0	0	0	72,605,364
1964	62,629,003	(751,330)	(14,000)	0	0	107,780	61,971,453
1965	71,048,877	(763,541)	(14,000)	0	0	551,850	70,823,186
1966	125,376,541	(748,649)	(14,000)	0	0	1,081,023	125,694,915
1967	94,481,603	(812,145)	(13,446)	0	0	1,189,212	94,845,224
1968	39,986,145	(431,574)	1,303,821	(951,000)	0	793,399	40,700,791
1969	5,367,865	(259,015)	2,890,772	(11,007,000)	0	801,867	(2,405,511)
1970	4,208,411	(203,733)	4,818,634	(14,650,000)	(1,500,000)	516,659	(6,810,029)
1971	3,956,703	(193,631)	6,026,480	(14,650,000)	(1,500,000)	408,754	(5,951,694)
1972	4,662,254	(196,361)	5,393,011	(14,650,000)	(1,500,000)	287,374	(6,003,722)
1973	4,090,078	(136,997)	6,136,774	(14,650,000)	(1,500,000)	203,384	(5,857,761)
1974	6,852,718	(137,503)	6,944,723	(17,950,000)	(1,500,000)	201,907	(5,588,155)
1975	8,343,833	(234,567)	7,697,390	(14,650,000)	(1,500,000)	146,188	(197,156)
1976	6,189,617	(204,944)	7,067,037	(14,650,000)	(1,500,000)	205,234	(2,893,056)
1977	21,554,452	(150,214)	10,547,977	(14,650,000)	(1,500,000)	857,419	16,659,634
1978	8,031,393	(64,566)	12,851,158	(14,650,000)	(1,500,000)	2,131,286	6,799,271
1979	9,751,861	0	9,547,014	(14,650,000)	(1,500,000)	2,131,884	5,280,759
1980	11,345,574	0	13,258,298	(14,650,000)	(1,500,000)	3,638,851	12,092,723
1981	11,921,267	0	10,326,538	(14,650,000)	(1,500,000)	4,597,474	10,695,279
1982	17,479,060	0	16,154,872	(14,650,000)	(1,500,000)	4,594,682	22,078,614
1983	12,763,378	0	22,251,331	(34,705,000)	(8,735,000)	3,751,993	(4,673,298)
1984	9,367,268	0	22,700,224	(14,650,000)	(10,348,000)	2,979,126	(10,048,618)
1985	12,538,173	0	23,462,283	(14,650,000)	(8,198,000)	2,069,024	15,221,480
1986	21,586,489	0	26,479,379	(14,650,000)	(9,107,000)	1,602,419	25,911,287
1987	32,734,633	0	23,479,839	(14,650,000)	(9,451,000)	1,762,179	33,875,651
1988	33,028,679	0	25,832,491	(14,650,000)	(8,677,000)	1,808,899	37,343,069
1989	11,075,132	0	28,442,946	(14,650,000)	(8,102,000)	2,678,007	19,444,085
1990	28,764,328	0	37,430,837	(14,650,000)	(8,498,000)	1,436,712	44,483,877
1991	37,462,303	0	76,586,733	(14,650,000)	(9,487,000)	1,727,664	91,639,700
1992	29,169,134	0	32,280,753	(14,650,000)	(8,526,000)	1,707,822	39,981,709
1993	22,366,872	0	36,984,149	(14,650,000)	(8,768,000)	1,708,490	37,541,511
1994	14,709,626	0	41,193,816	(14,650,000)	(7,484,000)	2,134,392	35,903,834
1995	15,120,857	0	46,177,149	(14,650,000)	(4,976,939)	2,042,481	43,713,548
1996	11,006,838	0	50,883,067	(14,650,000)	(5,503,289)	2,448,692	44,185,308
1997	15,304,365	0	51,775,267	(14,650,000)	(5,740,515)	1,699,730	46,388,847
1998	3,960,201	0	54,635,342	(14,650,000)	(8,165,000)	1,193,198	36,983,741
1999	6,093,496	0	55,911,570	(14,650,000)	(9,198,000)	9,686	38,166,752
2000	9,850,769	0	56,694,844	(14,709,325)	(10,452,028)	13,491	41,397,751
2001	9,848,141	0	76,188,738	(16,229,333)	(15,231,433)	23,866	54,599,979
2002	19,435,202	0	68,449,271	(19,569,786)	(22,034,770)	9,433	46,304,343
2003	22,575,172	0	77,756,386	(21,093,018)	(30,910,299)	28,826	48,338,074
2004	17,525,768	0	92,069,142	(18,391,690)	(34,155,125)	7,548	57,055,643
2005	(5,120,751)	0	103,486,017	(15,668,967)	(23,020,957)	0	59,675,342
2006	8,236,951	0	101,891,842	(15,292,151)	(25,134,386)	0	69,702,256
2007	7,694,799	0	87,730,780	(14,650,000)	(17,929,399)	0	62,846,180
2008	32,687,720	0	115,466,102	(14,650,000)	(16,037,251)	0	117,466,571
2009	40,355,173	0	154,842,568	(16,053,070)	(16,241,163)	0	162,903,508
2010	34,650,845	0	168,887,318	(16,053,070)	(16,186,497)	0	171,298,596
2011	25,752,832	0	72,965,186	(16,053,070)	(9,040,000)	0	73,624,948
2012	25,730,689	0	61,055,717	(16,053,070)	(9,040,000)	0	61,693,357
2013	22,883,054	0	64,554,692	(16,053,070)	(9,040,000)	0	62,344,677
2014	20,397,903	0	62,866,439	(16,053,070)	(9,040,000)	0	58,171,273
2015	20,397,903	0	60,630,568	(16,053,070)	(9,040,000)	0	55,935,402
2016	20,397,903	0	64,791,188	(16,053,070)	(9,040,000)	0	60,096,022
2017	20,397,903	0	63,865,857	(16,053,070)	(9,040,000)	0	59,170,691
2018	20,397,903	0	64,356,800	(16,053,070)	(9,040,000)	0	59,661,634
2019	397,903	0	63,074,658	(16,053,070)	(9,040,000)	0	38,379,492
2020	397,903	0	60,306,488	(16,053,070)	(9,040,000)	0	35,611,322
2021	397,903	0	65,614,826	(16,053,070)	(9,040,000)	0	40,919,660
2022	397,903	0	64,192,768	(16,053,070)	(9,040,000)	0	39,497,601
2023	397,903	0	60,856,937	(16,053,070)	(9,040,000)	0	36,161,770
2024	397,903	0	61,913,881	(16,053,070)	(9,040,000)	0	37,218,714
2025	397,903	0	67,000,427	(16,053,070)	(9,040,000)	0	42,305,260
2026	397,903	0	64,048,920	(16,053,070)	(9,040,000)	0	39,353,753
2027	397,903	0	60,380,158	(16,053,070)	(9,040,000)	0	35,684,991
2028	397,903	0	60,895,843	(16,053,070)	(9,040,000)	0	36,200,676
2029	397,903	0	67,679,576	(16,053,070)	(9,040,000)	0	42,984,408
2030	397,903	0	62,905,367	(14,650,000)	(9,040,000)	0	39,613,270
2031	397,903	0	61,413,195	(14,650,000)	(9,040,000)	0	38,121,098
2032	397,903	0	60,832,534	(14,650,000)	(9,040,000)	0	37,540,437
2033	397,903	0	66,475,221	(14,650,000)	(9,040,000)	0	43,183,124
2034	397,903	0	62,825,581	(14,650,000)	(9,040,000)	0	39,533,484
2035	397,903	0	63,438,376	(14,650,000)	(14,000,000)	0	35,186,279
TOTAL	1,360,036,639	(11,528,320)	3,469,705,439	(1,050,081,734)	(616,748,051)	57,085,905	3,208,469,878

- a) Reimbursed through the capital cost component of the Delta Water Charge.
- b) Negotiated settlements as to the magnitude of SWP planning costs from 1952 through 1978.
- c) Reimbursed through the minimum OMP&R component of the Delta Water Charge. Credits for Gianelli power generation are reflected in these net costs.
- d) Revenues credited through the capital cost component of the Delta Water Charge.
- e) Revenues credited through the minimum OMP&R component of the Delta Water Charge.
- f) Under amendments of Articles 22(e) and 22(g), planning and pre-operating costs of additional Project Conservation Facilities incurred through 2007 reflected in the Delta Water Charge.

**TABLE B-14. Capital Costs of Transportation Facilities Allocated to Each Contractor**

(in dollars)

Sheet 1 of 4

Calendar Year	NORTH BAY AREA			SOUTH BAY AREA				CENTRAL COASTAL AREA		
	Napa County FC&WCD	Solano County WA (a)	Total	Alameda County FC&WCD, Zone 7	Alameda County Water District	Santa Clara Valley Water District	Total	San Luis Obispo County FC&WCD	Santa Barbara County FC&WCD	Total
	[1]	[2]	[3]	[4]	[5]	[6]	[7]	[8]	[9]	[10]
1952	0	0	0	83	114	410	607	122	224	346
1953	0	0	0	323	479	1,808	2,610	336	620	956
1954	0	0	0	819	1,306	5,150	7,275	421	777	1,198
1955	0	0	0	977	1,570	6,297	8,844	211	390	601
1956	0	0	0	8,844	14,459	63,816	87,119	227	418	645
1957	15,199	11,436	26,635	21,564	35,240	649,596	706,400	291	536	827
1958	33,420	16,591	50,011	67,764	71,717	733,414	872,895	720	1,328	2,048
1959	20,697	6,591	27,288	154,255	143,730	493,050	791,035	10,636	69,139	79,775
1960	9,097	8,830	17,927	296,492	275,610	1,018,661	1,590,763	15,255	99,794	115,049
1961	6,950	7,445	14,395	853,506	802,675	1,914,709	3,570,890	10,163	36,681	46,844
1962	(194)	(926)	(1,120)	545,123	615,141	1,686,041	2,846,305	17,281	39,570	56,851
1963	1,319	1,111	2,430	657,426	1,281,271	3,243,838	5,182,535	68,821	140,841	209,662
1964	38,393	35,466	73,859	712,650	1,747,783	7,251,800	9,712,233	138,614	282,003	420,617
1965	198,833	62,221	261,054	360,779	606,025	3,414,457	4,381,261	250,706	497,152	747,858
1966	461,619	49,917	511,536	592,714	592,598	2,245,215	3,430,527	587,951	1,117,486	1,705,437
1967	1,569,498	40,379	1,609,877	796,995	803,951	2,401,862	4,002,808	936,412	1,762,694	2,699,106
1968	859,613	61,691	921,304	736,470	696,075	1,997,924	3,430,469	351,131	675,220	1,026,351
1969	74,388	59,318	133,706	269,698	293,275	764,959	1,327,923	76,966	164,583	241,549
1970	43,361	67,877	111,238	58,676	61,200	135,569	255,445	47,891	109,224	157,115
1971	26,763	34,052	60,815	12,086	18,227	84,089	114,402	28,638	80,715	109,353
1972	19,643	18,905	38,548	12,293	12,763	63,610	88,666	19,289	50,230	69,519
1973	56,510	30,874	87,384	10,494	12,136	39,380	62,010	23,010	56,178	79,188
1974	165,830	65,832	231,662	15,722	24,402	73,119	113,243	25,037	61,383	86,420
1975	91,824	89,234	181,058	16,730	15,806	41,394	73,930	14,740	61,416	76,156
1976	57,765	83,651	141,416	34,004	34,663	109,610	178,277	33,638	130,440	164,078
1977	64,167	80,147	144,314	46,229	45,115	133,375	224,719	108,324	264,720	373,044
1978	69,319	81,717	151,036	71,234	66,008	174,898	312,140	21,415	103,822	125,237
1979	191,273	282,907	474,180	45,468	42,943	110,665	199,076	22,941	125,669	148,610
1980	264,433	386,006	650,439	134,522	124,352	304,614	563,488	103,258	462,895	566,153
1981	227,606	383,086	610,692	(33,738)	(29,856)	(65,637)	(129,231)	(15,416)	(135,240)	(150,656)
1982	549,184	870,611	1,419,795	7,876	8,321	27,065	43,282	4,102	(58,882)	(54,780)
1983	1,254,900	1,433,061	2,687,961	138,413	131,515	339,246	609,174	32,196	110,287	142,483
1984	2,547,878	2,750,040	5,297,918	152,992	140,971	351,921	645,884	35,448	107,723	143,171
1985	7,143,123	6,443,613	13,586,736	19,776	19,245	53,491	92,512	17,424	78,896	96,320
1986	10,565,937	16,926,630	27,492,567	32,034	31,581	88,070	151,685	44,135	306,452	350,587
1987	7,979,832	12,599,507	20,579,339	50,153	48,675	138,959	237,787	126,995	1,342,116	1,469,111
1988	2,312,909	4,343,513	6,656,422	116,181	112,294	302,461	530,936	156,473	1,479,545	1,636,018
1989	1,224,538	1,553,352	2,777,890	108,320	102,804	260,092	471,216	152,173	1,210,940	1,363,113
1990	443,002	824,055	1,267,057	224,283	224,188	625,213	1,073,684	222,208	1,559,457	1,781,665
1991	99,848	89,269	189,117	413,426	383,368	946,246	1,743,040	298,398	2,184,088	2,482,486
1992	57,045	62,083	119,128	182,231	169,968	442,055	794,254	361,210	3,504,755	3,865,965
1993	122,423	128,634	251,057	129,344	125,312	342,416	597,072	1,170,649	11,997,954	13,168,603
1994	71,274	83,270	154,544	46,042	58,050	229,649	333,741	4,260,734	46,401,596	50,662,330
1995	30,605	29,271	59,876	97,808	97,063	257,484	452,355	12,268,787	155,255,849	167,524,636
1996	20,275	19,069	39,344	49,854	48,056	127,493	225,403	11,284,548	145,409,409	156,693,957
1997	20,039	107,784	127,823	82,598	78,996	209,517	371,111	3,184,506	38,158,718	41,343,224
1998	17,423	21,572	38,995	27,302	24,121	63,057	114,480	883,110	10,563,359	11,446,469
1999	67,602	106,355	173,957	74,165	73,552	208,296	356,013	928,738	9,596,058	10,524,796
2000	16,252	37,932	54,184	27,445	28,844	80,346	136,635	488,160	5,529,102	6,017,262
2001	6,598	13,750	20,348	140,394	270,055	1,856,845	2,267,294	72,358	539,206	611,564
2002	19,917	45,940	65,857	805,478	1,189,615	5,876,842	7,871,935	63,183	376,338	439,521
2003	54,234	20,712	74,946	1,156,873	1,331,273	4,619,173	7,107,319	(2,558)	77,219	74,661
2004	153,537	20,912	174,449	594,344	572,306	4,645,748	5,812,398	9,185	48,719	57,904
2005	60,245	62,677	122,922	611,544	587,622	2,131,911	3,331,077	(10,804)	(179,970)	(190,774)
2006	888,719	22,745	911,464	1,000,638	954,823	2,291,038	4,246,499	69,474	755,133	824,607
2007	3,241,526	48,714	3,290,240	1,168,919	1,134,423	2,715,058	5,018,400	154,926	1,610,112	1,765,038
2008	5,508,002	573,446	6,081,448	2,866,717	2,720,470	6,627,881	12,215,068	221,732	1,970,577	2,192,309
2009	2,018,807	851,582	2,870,389	1,542,145	1,572,686	3,944,622	7,059,453	285,434	2,344,692	2,630,126
2010	608,559	582,155	1,190,714	538,121	583,166	1,536,150	2,657,437	230,489	2,034,595	2,265,084
2011	174,138	187,009	361,147	57,864	66,366	232,238	356,468	147,764	1,557,765	1,705,529
2012	173,056	185,846	358,902	57,504	65,954	230,795	354,253	146,846	1,548,082	1,694,928
2013	77,668	83,408	161,076	25,808	29,600	103,581	158,989	65,904	694,780	760,684
2014	0	0	0	0	0	0	0	0	0	0
2015	0	0	0	0	0	0	0	0	0	0
<b>TOTAL</b>	<b>52,096,401</b>	<b>53,092,875</b>	<b>105,189,276</b>	<b>19,046,794</b>	<b>21,396,061</b>	<b>71,002,643</b>	<b>111,445,498</b>	<b>40,272,956</b>	<b>454,375,579</b>	<b>494,648,535</b>

Note: Allocated capital costs as a result of permanent water transfers under Monterey are not reflected on this Table

a) Costs from Table B-10 allocated to Solano County Water Agency are reduced herein by \$2,102,700 in 1986 and \$1,823,500 in 1987 under provisions of Amendment No. 10 to its water supply contract.

**TABLE B-14. Capital Costs of Transportation Facilities Allocated to Each Contractor**

(in dollars)

Sheet 2 of 4

Calendar Year	SAN JOAQUIN VALLEY AREA									
	Dudley Ridge Water District	Empire West Side Irrigation District (b)	Future Contractor San Joaquin Valley	Kern County Water Agency			County of Kings	Oak Flat Water District	Tulare Lake Basin Storage District	Total
				Municipal and Industrial	Municipal and (c) Industrial	Agri-cultural				
[11]	[12]	[13]	[14]	[15]	[16]	[17]	[18]	[19]	[20]	
1952	389	20	58	938	119	9,129	20	12	785	11,470
1953	1,076	53	161	2,887	345	27,383	55	33	2,157	34,150
1954	1,350	68	201	3,373	417	32,369	69	43	2,718	40,608
1955	677	34	101	1,497	197	14,721	35	23	1,371	18,656
1956	726	34	108	2,702	273	24,255	35	25	1,416	29,574
1957	932	38	139	6,048	494	49,932	39	29	1,707	59,358
1958	2,308	102	344	14,374	1,153	119,049	104	61	4,368	141,863
1959	7,384	364	2,517	26,218	2,597	253,891	372	381	14,757	308,481
1960	12,940	630	3,666	34,054	4,155	352,166	644	498	25,696	434,449
1961	21,848	1,063	3,954	51,407	6,500	538,707	1,087	598	43,377	668,541
1962	49,320	2,410	7,867	94,933	13,834	1,017,146	2,465	1,879	98,141	1,287,995
1963	208,757	10,687	32,172	364,014	55,715	3,934,636	10,932	5,990	425,330	5,048,233
1964	328,286	16,961	64,890	600,152	88,904	6,636,279	17,350	11,942	672,013	8,436,777
1965	538,215	27,481	117,996	1,098,999	152,930	11,999,892	28,116	21,802	1,095,126	15,080,552
1966	1,107,757	52,586	279,172	2,218,832	339,222	24,857,487	53,789	38,891	2,173,090	31,120,826
1967	852,537	39,537	445,562	2,012,744	286,990	23,629,026	40,444	34,775	1,653,429	28,995,044
1968	198,739	9,739	166,267	1,104,132	70,086	11,544,942	9,962	12,238	396,075	13,512,180
1969	94,436	4,793	35,473	616,516	27,216	6,416,147	4,903	7,302	191,574	7,398,360
1970	54,344	2,720	21,686	414,659	15,520	4,145,046	2,782	3,999	109,470	4,770,226
1971	25,462	1,291	12,094	190,552	7,114	1,622,274	1,320	540	51,618	1,912,265
1972	11,589	589	8,354	82,886	3,409	723,623	602	343	23,526	854,921
1973	6,657	335	10,201	39,973	1,980	458,527	343	221	13,448	531,685
1974	9,478	469	11,044	45,420	2,766	483,866	479	326	18,979	572,827
1975	13,329	677	5,246	36,467	3,710	382,743	692	425	27,048	470,337
1976	17,506	837	12,615	53,085	5,621	654,026	856	1,152	34,455	780,153
1977	9,672	436	47,790	36,478	3,753	886,672	446	494	18,497	1,004,238
1978	23,499	(30,406)	6,178	54,219	6,579	575,169	1,209	1,402	47,446	685,295
1979	25,051	1,295	5,664	53,866	6,610	559,746	1,325	1,862	51,293	706,712
1980	144,980	(4,617)	31,160	321,890	38,126	3,211,810	7,682	7,144	297,215	4,055,390
1981	(5,427)	(15,464)	200	(44,773)	(1,223)	(385,275)	(296)	1,752	(11,324)	(461,830)
1982	49,916	2,584	6,600	83,283	13,142	654,692	2,638	1,252	102,287	916,394
1983	52,429	(35,295)	12,125	110,465	13,872	1,073,500	2,769	1,327	107,337	1,338,529
1984	86,345	4,474	14,303	154,799	22,764	1,617,225	4,572	2,678	177,020	2,084,180
1985	25,435	1,311	5,649	47,055	6,766	484,485	1,341	1,176	52,013	625,231
1986	38,309	(41,067)	9,862	171,661	10,320	796,097	2,009	778	78,142	966,111
1987	28,769	1,476	7,004	55,537	7,969	616,845	1,509	1,491	58,679	779,279
1988	52,329	2,831	17,078	70,572	12,049	909,046	2,894	4,620	109,713	1,181,132
1989	156,099	6,019	27,551	352,103	42,943	3,834,481	8,201	12,134	318,604	4,760,135
1990	292,361	15,142	50,360	553,394	87,199	6,094,021	15,487	22,729	599,233	7,729,926
1991	349,413	18,103	60,419	580,572	91,765	6,447,565	18,515	23,486	716,292	8,306,130
1992	125,891	6,439	28,019	241,559	34,559	2,711,639	6,585	10,883	256,370	3,421,944
1993	86,113	4,375	30,245	174,630	23,840	2,059,168	4,474	4,698	174,772	2,562,315
1994	64,762	3,323	23,894	124,518	17,633	1,488,418	3,398	2,173	132,095	1,860,214
1995	82,969	(1,000)	72,734	167,698	24,390	2,472,332	4,355	2,824	169,318	2,995,620
1996	27,611	(61,913)	51,990	68,870	8,812	1,233,548	1,437	1,590	56,092	1,388,037
1997	136,503	7,041	48,721	241,400	36,417	2,951,687	7,195	3,706	279,205	3,711,875
1998	70,737	(121,004)	23,083	122,934	18,622	1,474,568	3,742	1,278	144,963	1,738,923
1999	81,197	4,192	26,645	142,983	21,661	1,715,933	4,285	3,846	166,160	2,166,902
2000	21,089	1,073	9,822	45,704	6,013	547,927	1,096	(1,081)	42,826	674,469
2001	17,776	907	7,862	36,078	5,062	432,671	927	781	36,153	538,217
2002	74,205	3,811	16,014	132,974	20,050	1,498,693	3,898	727	151,445	1,901,817
2003	(51,175)	(2,675)	(5,510)	(76,111)	(13,087)	(822,799)	(2,736)	337	(105,393)	(1,079,149)
2004	7,784	398	2,528	17,202	2,101	185,079	408	1,521	15,858	232,879
2005	28,539	1,471	5,725	52,620	7,554	538,644	1,503	560	58,351	694,967
2006	5,314	272	1,181	21,770	1,423	105,318	279	613	10,832	147,002
2007	17,647	894	4,589	40,880	4,828	372,623	914	733	35,757	478,865
2008	77,716	3,911	26,175	166,912	21,765	1,792,868	4,001	3,701	156,978	2,254,027
2009	126,015	6,354	42,051	260,228	35,044	2,855,782	6,500	4,937	254,772	3,591,683
2010	77,526	3,890	27,666	176,173	21,835	1,826,338	3,979	2,673	156,352	2,296,432
2011	19,406	964	6,821	45,410	5,731	507,447	986	953	38,931	626,649
2012	19,285	958	6,779	45,128	5,696	504,294	979	947	38,689	622,755
2013	8,655	430	3,042	20,254	2,556	226,327	440	425	17,364	279,493
2014	0	0	0	0	0	0	0	0	0	0
2015	0	0	0	0	0	0	0	0	0	0
<b>TOTAL</b>	<b>6,020,787</b>	<b>(33,549)</b>	<b>2,003,907</b>	<b>13,887,797</b>	<b>1,766,406</b>	<b>153,981,846</b>	<b>306,441</b>	<b>276,678</b>	<b>12,092,011</b>	<b>190,302,324</b>

b) Costs from Table B-10 allocated to Empire West Side Irrigation District are reduced herein by \$31,588 in 1978; \$12,129 in 1980; \$15,173 in 1981; \$38,004 in 1983; \$43,033 in 1986; \$5,261 in 1995; \$63,318 in 1996 and \$124,667 in 1998 in accordance with letters of agreement with the district.  
c) Costs related to maximum annual entitlement of 15,000 acre-feet under Amendment No. 18 of the water supply contract with Kern County Water Agency.

**TABLE B-14. Capital Costs of Transportation Facilities Allocated to Each Contractor**

(in dollars)

Sheet 3 of 4

Calendar Year	SOUTHERN CALIFORNIA AREA									
	Antelope Valley-East Kern Water Agency	Castaic Lake Water Agency (d)	Coachella Valley Water District	Crestline-Lake Arrowhead Water Agency	Desert Water Agency	Littlerock Creek Irrigation District	Mojave Water Agency	Palmdale Water District	San Bernardino Valley Municipal Water District	San Gabriel Valley Municipal Water District
	[21]	[22]	[23]	[24]	[25]	[26]	[27]	[28]	[29]	[30]
1952	3,158	1,042	850	254	1,402	70	1,695	418	6,079	1,550
1953	10,026	3,327	2,668	799	4,401	222	5,318	1,328	19,058	4,852
1954	12,742	4,193	3,465	1,031	5,714	285	6,908	1,691	24,608	6,290
1955	5,411	1,881	1,374	401	2,267	115	2,756	715	9,229	2,377
1956	9,775	3,590	2,196	612	3,622	191	4,449	1,267	13,138	3,438
1957	26,306	9,255	6,343	1,816	10,461	540	12,767	3,450	40,646	10,534
1958	49,204	17,599	11,581	3,290	19,099	991	23,360	6,414	72,708	18,898
1959	70,247	29,740	15,869	4,616	26,171	1,347	31,759	9,030	98,596	25,519
1960	84,552	38,760	22,068	6,797	36,395	1,547	43,260	10,772	147,170	37,469
1961	126,542	54,262	34,613	12,530	57,086	2,245	63,709	16,437	236,164	57,707
1962	198,558	85,352	43,719	13,861	72,102	3,344	84,709	24,943	253,435	64,330
1963	580,138	255,252	116,797	33,149	192,624	9,828	234,926	73,256	610,277	160,624
1964	1,094,365	501,858	209,462	55,445	345,446	18,442	429,605	137,769	1,026,066	276,118
1965	1,908,076	947,523	385,533	103,757	635,825	32,819	786,986	244,587	1,913,090	512,862
1966	3,960,302	2,150,972	812,655	215,858	1,340,235	69,325	1,664,584	517,269	3,943,586	1,062,417
1967	4,976,538	4,100,531	1,077,422	296,069	1,776,892	88,301	2,182,240	653,250	5,821,681	1,550,239
1968	5,924,474	3,998,942	1,350,742	368,156	2,227,646	107,350	2,738,009	783,940	7,982,824	2,122,940
1969	5,822,708	3,079,426	1,690,259	539,851	2,787,631	121,303	3,256,507	865,455	10,898,185	2,769,647
1970	5,032,959	3,277,778	2,050,788	695,345	3,382,251	106,381	3,872,367	736,775	13,795,809	3,457,109
1971	2,577,507	2,146,954	1,071,523	338,581	1,767,179	48,337	2,087,223	347,057	8,137,053	1,987,120
1972	973,436	283,257	331,759	92,079	547,138	19,134	668,550	134,360	5,821,137	973,970
1973	354,407	914,303	158,579	82,223	261,557	6,304	238,094	46,102	1,760,570	403,582
1974	451,450	280,861	259,175	74,113	427,433	8,143	518,453	59,145	1,617,394	425,927
1975	253,438	246,492	193,632	52,821	319,337	4,954	392,110	33,995	1,533,664	407,913
1976	237,539	255,238	136,751	37,235	225,529	4,245	277,807	31,002	962,280	255,901
1977	199,554	371,469	91,384	25,858	150,711	3,757	183,609	15,445	591,445	155,537
1978	302,111	470,176	78,573	22,226	129,584	5,233	157,815	38,654	428,989	111,769
1979	357,678	938,985	81,807	21,795	134,915	5,965	166,931	44,410	403,569	108,408
1980	1,867,517	1,777,294	423,755	113,166	698,855	32,435	864,104	240,899	2,040,757	548,085
1981	(158,728)	610,795	(47,102)	(8,865)	(77,678)	(2,576)	(102,568)	(19,588)	(143,875)	(43,557)
1982	1,557,934	861,928	298,770	78,903	492,728	26,237	613,587	196,672	1,421,407	388,261
1983	2,062,512	521,349	396,033	115,678	653,134	34,699	803,945	259,939	2,126,313	581,672
1984	1,518,361	295,783	297,559	85,097	490,731	27,272	606,124	188,562	1,546,628	423,408
1985	896,226	158,810	217,115	62,532	358,064	13,104	441,299	107,533	1,116,949	305,291
1986	841,555	104,860	221,194	58,152	364,790	9,038	454,702	93,309	1,048,625	286,302
1987	333,052	105,625	166,099	43,992	273,928	5,566	340,485	40,716	783,725	213,202
1988	259,234	174,155	65,831	22,723	108,570	3,384	128,339	26,743	429,498	113,644
1989	1,045,999	434,394	323,138	97,036	532,920	16,777	649,616	125,344	1,375,722	372,048
1990	678,053	374,313	332,566	97,789	548,468	7,335	672,344	67,179	1,509,745	409,710
1991	831,687	401,961	367,196	120,925	605,579	11,966	733,443	92,625	1,979,364	540,210
1992	633,272	356,952	270,826	131,328	446,647	9,556	501,634	76,760	2,093,387	573,386
1993	634,283	332,089	222,347	171,095	366,700	10,194	353,470	73,955	3,848,084	1,046,752
1994	467,409	165,607	132,599	93,839	218,685	7,255	218,494	53,209	2,347,599	637,733
1995	459,990	293,308	132,690	78,390	218,835	7,436	232,377	54,544	1,959,986	530,666
1996	299,764	206,742	110,520	44,965	182,270	4,885	211,872	35,808	4,004,066	972,829
1997	438,898	249,699	103,382	24,640	170,497	7,397	214,534	54,452	2,819,566	397,103
1998	234,379	202,650	62,492	41,136	103,063	3,989	106,009	29,551	3,550,447	303,255
1999	268,224	175,939	89,312	40,069	147,294	4,812	167,592	35,399	5,481,780	235,054
2000	139,035	77,889	54,795	23,903	90,369	2,665	103,194	19,150	13,636,062	171,107
2001	130,754	44,790	50,816	15,641	83,805	2,989	102,254	20,949	19,271,172	96,254
2002	167,056	107,515	34,405	11,395	56,741	2,453	68,208	18,551	9,606,903	126,427
2003	(45,647)	(11,440)	2,964	2,129	4,889	(800)	4,230	(5,944)	3,760,236	27,246
2004	63,550	39,157	20,270	5,614	33,429	1,142	41,333	8,311	2,049,997	38,649
2005	184,751	105,245	38,520	11,938	63,527	3,215	75,979	23,651	956,455	60,919
2006	327,057	244,870	69,967	26,087	115,394	5,501	129,287	41,172	1,978,640	117,302
2007	267,036	188,958	65,754	25,185	108,442	4,700	126,016	34,352	2,100,382	121,910
2008	698,665	429,826	269,310	106,227	444,161	12,833	493,270	92,418	2,153,833	498,969
2009	946,440	662,918	501,103	143,363	826,421	17,689	1,004,745	126,171	2,763,642	705,641
2010	897,731	802,377	444,176	117,219	732,531	16,288	911,078	117,883	2,225,795	591,333
2011	179,323	117,479	52,094	16,757	85,914	3,268	102,215	23,962	357,961	93,014
2012	178,209	116,748	51,770	16,652	85,380	3,248	101,580	23,813	355,736	92,436
2013	79,980	52,397	23,234	7,474	38,319	1,457	45,589	10,687	159,654	41,485
2014	0	0	0	0	0	0	0	0	0	0
2015	0	0	0	0	0	0	0	0	0	0
<b>TOTAL</b>	<b>54,986,762</b>	<b>35,252,000</b>	<b>16,107,087</b>	<b>5,142,722</b>	<b>26,564,055</b>	<b>988,127</b>	<b>31,656,886</b>	<b>7,239,062</b>	<b>167,754,692</b>	<b>28,316,770</b>

d) Costs from Table B-10 allocated to Castaic Lake Water Agency are reduced herein by \$14,088 in 1978 in accordance with a letter of agreement with the district.

**TABLE B-14. Capital Costs of Transportation Facilities Allocated to Each Contractor**

(in dollars)

Sheet 4 of 4

Calendar Year	SOUTHERN CALIFORNIA AREA (continued)				FEATHER RIVER AREA				South Bay Area Future Contractor	GRAND TOTAL
	San Gorgonio Pass Water Agency	The Metropolitan Water District of Southern California (e)	Ventura County Watershed Protection District	Total	City of Yuba City	County of Butte	Plumas County FC&WCD	Total		
	[31]	[32]	[33]	[34]	[35]	[36]	[37]	[38]	[39]	[40]
1952	962	69,020	370	86,870	0	0	0	0	59	99,352
1953	3,011	217,634	1,187	273,831	0	0	0	0	264	311,811
1954	3,904	279,967	1,496	352,294	0	0	0	0	766	402,141
1955	1,474	111,602	670	140,272	0	0	0	0	969	169,342
1956	2,127	179,335	1,299	225,039	0	0	0	0	9,172	351,549
1957	6,526	516,050	3,367	648,061	0	0	0	0	23,172	1,464,453
1958	11,701	945,684	6,390	1,186,919	0	0	2	2	32,888	2,286,626
1959	15,815	1,364,298	9,894	1,702,901	0	0	14	14	57,918	2,967,412
1960	23,307	1,914,521	12,798	2,379,416	0	0	28	28	123,202	4,660,834
1961	36,153	3,212,125	18,770	3,928,343	0	0	10	10	316,220	8,545,243
1962	40,012	3,543,471	29,069	4,456,905	0	0	32	32	228,202	8,875,170
1963	99,266	11,185,928	86,807	13,638,872	0	0	51	51	528,496	24,610,279
1964	170,012	18,065,455	164,709	22,494,752	0	0	7,791	7,791	590,034	41,736,063
1965	316,082	33,763,577	307,475	41,856,192	0	0	3,139	3,139	332,680	62,664,741
1966	654,194	74,485,027	681,898	91,558,322	0	0	(48)	(48)	783,728	129,110,328
1967	958,406	130,589,417	1,279,076	155,360,062	0	0	47	47	1,479,421	194,146,365
1968	1,314,841	147,502,290	1,360,687	177,782,841	0	0	51,573	51,573	1,254,192	197,978,910
1969	1,726,891	140,096,646	1,085,026	174,739,535	0	0	234,232	234,232	398,183	184,473,488
1970	2,160,122	161,983,078	1,147,609	201,698,371	0	0	16,227	16,227	74,028	207,082,650
1971	1,237,573	133,903,316	738,822	156,388,245	0	0	27,204	27,204	12,457	158,624,741
1972	434,507	43,931,880	66,878	50,872,072	0	0	9	9	13,182	51,936,917
1973	256,711	39,723,010	290,020	44,495,462	0	0	25	25	8,099	45,263,853
1974	264,349	18,896,593	86,362	23,369,398	0	0	45	45	28,570	24,402,165
1975	253,838	16,732,939	83,975	20,509,108	0	0	21	21	8,226	21,318,836
1976	158,850	13,545,451	84,623	16,212,451	0	0	51	51	16,486	17,492,912
1977	96,517	11,769,352	110,833	13,776,860	0	0	28	28	21,181	15,544,384
1978	69,152	15,781,696	174,876	17,770,854	0	0	38	38	28,876	19,073,476
1979	66,847	27,627,424	343,361	30,302,095	0	0	23	23	26,668	31,857,364
1980	337,811	59,493,774	641,586	69,080,038	0	0	26	26	59,169	74,974,703
1981	(26,356)	15,661,179	224,257	15,865,338	0	0	34	34	(6,746)	15,727,601
1982	238,792	30,873,857	316,107	37,365,183	0	0	11	11	16,086	39,705,931
1983	357,812	25,056,047	187,121	33,156,254	0	0	19	19	72,225	38,006,645
1984	260,327	16,317,441	103,160	22,160,453	0	0	26	26	83,252	30,414,884
1985	187,699	10,243,779	56,162	14,164,563	0	0	29	29	16,338	28,581,729
1986	176,057	8,365,310	34,777	12,058,671	0	0	31	31	16,248	41,035,900
1987	131,163	6,955,356	36,142	9,429,051	0	0	32	32	29,062	32,523,661
1988	70,260	6,628,545	57,117	8,086,043	0	0	55	55	50,083	18,140,689
1989	227,772	18,531,880	153,200	23,885,646	0	0	44	44	43,324	33,301,368
1990	251,185	17,430,869	125,376	22,504,932	0	0	63	63	96,419	34,453,746
1991	331,235	20,792,168	132,558	26,940,917	0	0	54	54	149,922	39,811,666
1992	351,492	21,196,762	116,999	26,759,001	0	0	42	42	80,900	35,041,234
1993	646,980	29,471,748	105,693	37,283,390	0	0	30	30	59,324	53,921,791
1994	394,936	16,392,019	50,941	21,180,325	0	0	14	14	34,208	74,225,376
1995	331,399	16,078,395	72,214	20,450,220	0	0	3	3	42,395	191,525,105
1996	1,100,219	23,237,696	49,282	30,460,918	0	0	0	0	21,388	188,829,047
1997	1,987,864	13,530,777	72,335	20,071,144	0	0	3	3	34,976	65,660,156
1998	3,352,042	11,284,364	65,745	19,339,122	0	0	7	7	11,234	32,689,230
1999	6,139,881	9,063,618	54,504	21,903,478	0	0	2	2	34,616	35,159,764
2000	17,011,985	5,393,221	24,010	36,747,385	0	0	24	24	16,912	43,646,871
2001	24,661,236	2,988,800	13,047	47,482,508	0	0	20	20	68,013	50,987,964
2002	11,956,286	5,297,703	34,824	27,488,467	0	0	14	14	380,629	38,148,240
2003	4,700,433	3,956,554	(4,162)	12,390,688	0	0	0	0	590,120	19,158,585
2004	2,388,748	4,291,031	13,324	8,994,556	0	0	0	0	601,409	15,873,595
2005	843,756	6,606,733	35,971	9,010,660	0	0	0	0	631,819	13,600,671
2006	1,884,507	13,921,013	89,639	18,950,436	0	0	5	5	1,167,320	26,247,333
2007	2,214,102	12,150,259	67,756	17,474,832	0	0	0	0	2,798,065	30,825,440
2008	311,169	28,892,133	145,309	34,548,123	0	0	0	0	1,000,750	58,291,725
2009	436,401	98,734,236	215,491	107,084,261	0	0	0	0	588,827	123,824,739
2010	364,113	176,904,742	257,058	184,382,324	0	0	0	0	220,921	193,012,912
2011	57,713	5,292,759	39,298	6,421,757	0	0	0	0	26,645	9,498,195
2012	57,354	5,259,863	39,054	6,381,843	0	0	0	0	26,479	9,439,160
2013	25,740	2,360,628	17,527	2,864,171	0	0	0	0	11,884	4,236,297
2014	0	0	0	0	0	0	0	0	0	0
2015	0	0	0	0	0	0	0	0	0	0
<b>TOTAL</b>	<b>94,145,265</b>	<b>1,800,599,845</b>	<b>11,821,769</b>	<b>2,280,575,041</b>	<b>0</b>	<b>0</b>	<b>341,130</b>	<b>341,130</b>	<b>15,471,555</b>	<b>3,197,973,359</b>

e) Costs from Table B-10 allocated to MWDSC are reduced herein by \$16,425,374 in 1972 under provisions of Amendment No. 7 to its water contract.

**TABLE B-15. Capital Cost Component of Transportation Charge for Each Contractor<sup>a b c</sup>**

(in dollars)

Sheet 1 of 4

Calendar Year	NORTH BAY AREA			SOUTH BAY AREA				CENTRAL COASTAL AREA		
	Napa County FC&WCD	Solano County WA	Total	Alameda County FC&WCD, Zone 7	Alameda County Water District	Santa Clara Valley Water District	Total	San Luis Obispo County FC&WCD	Santa Barbara County FC&WCD	Total
	[1]	[2]	[3]	[4]	[5]	[6]	[7]	[8]	[9]	[10]
1961	0	0	0	0	0	0	0	0	0	0
1962	0	0	0	0	0	0	0	0	0	0
1963	0	0	0	153,725	105,637	364,698	624,060	0	0	0
1964	0	0	0	216,131	170,872	529,854	916,857	6,694	21,659	28,353
1965	0	0	0	284,275	259,858	899,072	1,443,206	13,751	36,017	49,768
1966	18,057	0	18,057	320,279	290,714	1,072,916	1,683,908	26,516	61,329	87,845
1967	41,560	0	41,560	391,134	320,885	1,187,229	1,899,248	56,451	118,225	174,675
1968	121,469	0	121,469	507,659	361,817	1,309,517	2,178,994	104,127	207,970	312,097
1969	165,236	0	165,236	609,787	397,257	1,411,239	2,418,284	122,005	242,348	364,353
1970	169,023	0	169,023	644,110	412,189	1,450,186	2,506,485	125,923	250,728	376,651
1971	171,231	0	171,231	650,939	415,305	1,457,088	2,523,333	128,362	256,289	384,651
1972	172,593	0	172,593	652,269	416,233	1,461,370	2,529,872	129,820	260,399	390,218
1973	173,593	31,353	204,946	653,612	416,883	1,464,608	2,535,104	130,802	262,956	393,758
1974	176,471	32,924	209,395	654,605	417,501	1,466,613	2,538,720	131,973	265,816	397,789
1975	184,914	36,276	221,190	656,917	418,743	1,470,336	2,545,996	133,248	268,942	402,189
1976	189,589	40,819	230,408	658,245	419,548	1,472,444	2,550,237	133,998	272,068	406,067
1977	192,530	45,078	237,608	660,918	421,313	1,478,024	2,560,255	135,711	278,710	414,421
1978	195,797	49,159	244,956	664,501	423,610	1,484,815	2,572,926	141,226	292,188	433,414
1979	199,326	53,320	252,646	669,806	426,971	1,493,720	2,590,497	142,317	297,474	439,790
1980	209,065	67,724	276,788	673,602	429,157	1,499,354	2,602,113	143,485	303,872	447,357
1981	222,528	87,377	309,905	683,756	435,488	1,514,863	2,634,107	148,742	327,440	476,182
1982	234,116	106,881	340,997	681,644	433,968	1,511,521	2,627,134	147,957	320,554	468,511
1983	262,076	151,207	413,284	682,894	434,392	1,512,899	2,630,186	148,186	317,556	465,722
1984	325,968	224,170	550,139	693,992	441,088	1,530,172	2,665,251	149,805	323,171	472,976
1985	455,691	364,186	819,877	706,409	448,265	1,548,089	2,702,764	151,610	328,656	480,266
1986	819,376	692,256	1,511,632	708,310	449,245	1,550,813	2,708,368	152,497	332,673	485,170
1987	1,360,258	1,558,749	2,919,007	710,895	450,862	1,555,321	2,717,078	154,756	348,361	503,117
1988	1,771,094	2,207,426	3,978,520	715,118	453,368	1,562,476	2,730,961	161,295	417,458	578,753
1989	1,890,890	2,432,396	4,323,286	724,006	459,184	1,578,141	2,761,331	169,399	494,091	663,490
1990	1,954,717	2,513,362	4,468,079	732,058	464,542	1,591,698	2,788,299	177,331	557,209	734,540
1991	1,977,962	2,556,601	4,534,563	749,162	476,306	1,624,504	2,849,971	188,990	639,036	828,026
1992	1,983,238	2,561,318	4,544,556	779,751	496,563	1,674,504	2,950,819	204,758	754,445	959,203
1993	1,986,275	2,564,623	4,550,898	794,107	505,611	1,698,036	2,997,754	223,986	941,012	1,164,998
1994	1,992,843	2,571,524	4,564,367	804,535	512,334	1,716,406	3,033,275	286,790	1,584,690	1,871,480
1995	1,996,698	2,576,028	4,572,726	809,009	515,474	1,728,828	3,053,311	517,259	4,094,617	4,611,877
1996	1,998,368	2,577,625	4,575,993	816,911	520,770	1,742,877	3,080,558	1,186,671	12,565,710	13,752,380
1997	1,999,484	2,578,675	4,578,160	820,960	523,416	1,749,897	3,094,273	1,808,036	20,572,449	22,380,486
1998	2,000,598	2,584,668	4,585,266	827,688	527,808	1,761,546	3,117,042	1,985,088	22,693,988	24,679,076
1999	2,001,577	2,585,880	4,587,456	829,916	529,163	1,765,088	3,124,167	2,034,690	23,287,310	25,322,000
2000	2,005,415	2,591,918	4,597,333	887,819	533,339	1,776,914	3,298,085	2,087,421	23,832,146	25,919,567
2001	2,324,800	2,780,056	5,104,856	1,120,489	534,995	1,781,529	3,437,013	2,115,456	24,149,673	26,265,129
2002	2,325,240	2,780,895	5,106,135	1,134,888	550,693	1,889,460	3,575,040	2,119,661	24,181,015	26,300,677
2003	2,326,584	2,783,704	5,110,288	1,219,555	620,730	2,235,455	4,075,740	2,123,381	24,203,172	26,326,553
2004	2,330,267	2,784,997	5,115,264	1,353,090	700,178	2,511,117	4,564,385	2,123,229	24,207,760	26,331,009
2005	2,340,832	2,786,359	5,127,192	1,412,921	734,827	2,792,381	4,940,129	2,123,785	24,210,730	26,334,514
2006	2,345,062	2,790,570	5,135,633	1,473,886	770,950	2,923,437	5,168,273	2,123,121	24,199,666	26,322,787
2007	2,408,144	2,792,121	5,200,265	1,575,065	830,606	3,066,580	5,472,252	2,127,461	24,246,846	26,374,308
2008	2,642,219	2,795,505	5,437,724	1,696,110	902,718	3,239,168	5,837,996	2,137,309	24,349,196	26,486,506
2009	3,047,535	2,835,437	5,882,972	1,995,708	1,078,858	3,668,296	6,742,863	2,151,666	24,776,783	26,928,479
2010	3,199,294	2,896,188	6,095,482	2,164,719	1,182,698	3,928,749	7,276,165	2,170,512	24,631,597	26,802,109
2011	3,246,149	2,938,538	6,184,687	2,226,263	1,222,016	4,032,320	7,480,600	2,186,052	24,768,775	26,954,827
2012	3,259,874	2,952,141	6,212,015	2,233,113	1,226,592	4,048,332	7,508,038	2,196,240	24,876,178	27,072,418
2013	3,273,844	2,965,986	6,239,830	2,064,892	1,125,612	3,699,933	6,890,437	2,206,610	24,985,500	27,192,110
2014	3,280,277	2,972,361	6,252,638	1,998,007	1,062,522	3,542,281	6,602,811	2,204,691	25,014,180	27,218,871
2015	3,280,277	2,972,361	6,252,638	1,922,673	973,536	3,173,063	6,069,272	2,197,634	24,999,822	27,197,456
2016	3,259,711	2,972,361	6,232,072	1,883,495	942,681	2,999,219	5,825,395	2,184,869	24,974,510	27,159,380
2017	3,232,998	2,972,361	6,205,359	1,808,906	912,509	2,884,906	5,606,322	2,154,934	24,917,615	27,072,549
2018	3,142,216	2,972,361	6,114,577	1,689,254	871,577	2,762,618	5,323,449	2,107,258	24,827,869	26,935,127
2019	3,092,482	2,972,361	6,064,843	1,583,765	836,137	2,660,896	5,080,798	2,089,380	24,793,491	26,882,871
2020	3,088,160	2,972,361	6,060,521	1,547,980	821,205	2,621,949	4,991,135	2,085,462	24,785,111	26,870,573
2021	3,085,629	2,972,361	6,057,990	1,540,785	818,089	2,615,047	4,973,921	2,083,023	24,779,550	26,862,574
2022	3,084,069	2,972,361	6,056,430	1,539,409	817,161	2,610,765	4,967,336	2,081,565	24,775,441	26,857,006
2023	3,082,927	2,938,843	6,021,769	1,538,000	816,511	2,607,527	4,962,039	2,080,583	24,772,883	26,853,466
2024	3,079,647	2,937,209	6,016,857	1,536,938	815,893	2,605,522	4,958,354	2,079,412	24,770,023	26,849,435
2025	3,070,035	2,933,634	6,003,669	1,534,603	814,651	2,601,799	4,951,053	2,078,137	24,766,898	26,845,035
2026	3,064,693	2,928,881	5,993,574	1,533,130	813,846	2,599,691	4,946,668	2,077,387	24,763,771	26,841,157
2027	3,061,323	2,924,448	5,985,771	1,530,144	812,081	2,594,111	4,936,336	2,075,674	24,757,129	26,832,803
2028	3,057,584	2,920,190	5,977,774	1,526,136	809,785	2,587,320	4,923,240	2,070,159	24,743,652	26,813,810
2029	3,053,548	2,915,824	5,969,371	1,520,140	806,424	2,578,415	4,904,979	2,069,068	24,738,366	26,807,434
2030	3,042,395	2,900,366	5,942,761	1,515,945	804,237	2,572,781	4,892,963	2,067,900	24,731,967	26,799,868
2031	3,026,983	2,879,307	5,906,290	1,504,466	797,906	2,557,272	4,859,644	2,062,643	24,708,399	26,771,043
2032	3,013,691	2,858,369	5,872,059	1,506,982	799,426	2,560,614	4,867,022	2,063,428	24,715,285	26,778,713
2033	2,981,641	2,810,933	5,792,574	1,505,741	799,003	2,559,236	4,863,979	2,063,219	24,718,283	26,781,502
2034	2,908,568	2,734,341	5,642,908	1,493,322	792,307	2,541,963	4,827,592	2,061,580	24,712,668	26,774,248
2035	2,760,471	2,588,085	5,348,556	1,479,480	785,129	2,524,046	4,788,655	2,059,775	24,707,183	26,766,958
<b>TOTAL</b>	<b>134,438,794</b>	<b>137,347,701</b>	<b>271,786,496</b>	<b>81,891,469</b>	<b>46,139,770</b>	<b>154,845,477</b>	<b>282,876,716</b>	<b>87,893,921</b>	<b>981,390,568</b>	<b>1,069,284,488</b>

a) Unadjusted for prior overpayments or underpayments of charges.  
 b) Determined at the current Project Interest Rate of 4.608 percent per annum.  
 c) Reflects the transfers of permanent aqueduct capacity among contractors.



**TABLE B-15. Capital Cost Component of Transportation Charge for Each Contractor**

(in dollars)

Sheet 2 of 4

Calendar Year	SAN JOAQUIN VALLEY AREA									
	Dudley Ridge Water District	Empire West Side Irrigation District	Future Contractor San Joaquin Valley	Kern County Water Agency			County of Kings	Oak Flat Water District	Tulare Lake Basin Water Storage District	Total
				Municipal and Industrial	Municipal and (d Industrial	Agri-cultural				
	[11]	[12]	[13]	[14]	[15]	[16]	[17]	[18]	[19]	[20]
1961	0	0	0	0	0	0	0	0	0	0
1962	0	0	0	0	0	0	0	0	0	0
1963	0	0	0	0	0	0	0	0	0	0
1964	0	0	2,724	0	0	0	0	0	0	2,724
1965	0	0	6,027	64,262	9,281	0	0	0	0	79,571
1966	0	0	12,035	120,217	17,068	0	0	0	0	149,319
1967	0	0	26,249	233,186	34,339	0	0	0	0	293,774
1968	77,603	1,757	48,934	335,663	48,951	424,728	9,404	4,745	65,490	1,017,274
1969	77,738	5,271	57,399	391,879	52,519	872,244	10,154	5,157	247,790	1,720,152
1970	85,200	5,271	59,206	423,268	53,905	1,060,909	10,442	5,364	183,368	1,886,933
1971	97,139	5,271	60,310	444,380	54,695	1,409,079	10,608	5,776	195,129	2,282,387
1972	108,535	5,271	60,925	454,082	55,057	2,109,974	10,690	11,070	601,963	3,417,567
1973	119,389	5,271	61,351	458,302	55,231	2,433,531	10,733	6,395	232,829	3,383,031
1974	181,199	5,271	61,870	460,337	55,331	2,725,192	10,766	7,161	386,461	3,893,589
1975	220,082	5,271	62,432	462,650	55,472	3,264,032	10,808	7,377	461,139	4,549,263
1976	167,801	5,271	62,700	464,506	55,661	3,518,595	10,849	8,332	329,888	4,623,603
1977	164,973	5,271	63,342	467,209	55,947	3,855,370	10,911	7,633	315,417	4,946,073
1978	176,370	0	65,775	469,066	56,138	4,285,571	11,016	8,046	338,403	5,410,386
1979	209,169	5,271	66,090	471,827	56,473	4,705,740	11,082	8,252	380,858	5,914,762
1980	222,497	5,271	66,378	474,569	56,810	5,135,026	11,153	11,759	383,313	6,366,776
1981	222,497	5,271	67,964	490,958	58,751	5,619,910	11,561	8,871	406,299	6,892,083
1982	222,497	5,271	67,975	488,679	58,689	6,067,424	11,548	9,283	428,752	7,360,117
1983	232,808	5,271	68,311	492,919	59,358	6,576,916	11,681	7,777	51,045	7,506,085
1984	244,747	5,271	68,928	496,543	60,064	6,899,566	11,830	9,902	334,721	8,133,572
1985	256,143	5,271	69,656	506,425	61,223	7,347,079	12,065	10,109	243,509	8,511,480
1986	267,539	5,271	69,944	508,820	61,568	7,476,035	12,137	10,521	519,636	8,931,470
1987	278,935	5,271	70,449	512,489	62,096	8,243,021	12,247	10,728	542,089	9,737,324
1988	290,331	5,271	70,809	515,348	62,506	8,665,014	12,330	11,140	564,542	10,197,291
1989	301,728	5,271	71,694	519,003	63,130	9,969,433	12,497	11,553	587,530	10,541,839
1990	156,562	5,271	73,130	537,356	65,369	9,285,702	12,932	11,759	633,507	10,781,587
1991	289,848	5,271	75,772	566,393	69,944	9,285,702	13,757	11,759	633,507	10,951,954
1992	313,124	5,271	78,965	597,071	74,793	9,285,702	14,752	11,759	633,507	11,014,944
1993	313,124	5,271	80,456	609,930	76,633	9,285,702	15,120	11,759	633,507	11,031,502
1994	313,124	5,271	82,079	619,299	77,912	9,285,702	15,392	11,759	633,507	11,044,045
1995	313,124	5,271	83,371	626,034	78,865	9,285,702	15,603	11,759	633,507	11,053,237
1996	289,627	5,271	87,340	635,184	80,196	8,967,034	15,956	11,759	633,507	10,725,874
1997	289,627	5,271	90,203	638,976	80,681	8,901,316	16,128	11,759	633,507	10,667,468
1998	289,626	5,271	92,911	652,398	82,706	8,641,205	16,583	11,759	633,507	10,425,966
1999	289,626	5,271	94,208	659,302	83,752	8,641,205	16,818	11,759	633,507	10,435,449
2000	289,626	5,271	95,721	667,421	84,982	7,994,983	17,090	11,759	633,507	9,800,360
2001	289,626	5,271	96,285	670,045	85,327	7,865,254	17,167	11,759	633,507	9,674,241
2002	311,601	5,271	96,742	672,142	85,621	7,865,254	17,231	11,759	594,806	9,660,428
2003	311,601	5,271	97,685	679,971	86,802	7,865,254	17,471	11,759	592,584	9,668,398
2004	311,601	5,271	97,356	675,429	86,021	7,853,205	44,764	11,759	510,214	9,595,620
2005	311,601	5,271	97,509	676,470	86,148	7,853,205	44,792	11,759	510,214	9,596,969
2006	311,601	5,271	97,861	679,705	86,612	7,853,205	46,561	11,759	508,534	9,601,110
2007	311,601	5,271	97,935	681,065	86,701	7,853,205	46,580	11,759	508,534	9,602,651
2008	311,601	5,271	98,226	683,664	87,008	7,853,205	46,642	11,759	508,534	9,605,911
2009	335,099	5,271	99,921	694,471	88,417	8,227,609	46,934	11,759	508,534	10,018,016
2010	335,099	5,271	102,698	711,653	90,731	8,227,609	47,417	11,759	508,534	10,040,771
2011	335,099	5,271	104,563	723,531	92,203	8,227,609	47,724	11,759	508,534	10,056,293
2012	335,099	5,271	105,033	726,662	92,599	8,227,609	47,801	11,759	508,534	10,060,367
2013	335,099	5,271	105,512	729,849	93,001	8,227,609	47,880	11,759	508,534	10,064,514
2014	335,099	5,271	103,009	731,316	93,186	8,227,609	47,916	11,759	508,534	10,063,700
2015	335,099	5,271	99,705	667,054	83,905	8,227,609	47,916	11,759	508,534	9,986,852
2016	335,099	5,271	93,697	611,099	76,118	8,227,609	47,916	11,759	508,534	9,917,104
2017	335,099	5,271	79,484	498,130	58,847	8,227,609	47,916	11,759	508,534	9,772,649
2018	335,099	5,271	56,798	395,653	44,236	8,227,609	38,513	11,759	508,534	9,623,472
2019	335,099	5,271	48,333	339,437	40,667	8,227,609	37,762	11,759	508,534	9,554,471
2020	335,099	5,271	46,527	308,048	39,281	8,227,609	37,474	11,759	508,534	9,519,603
2021	335,099	5,271	45,423	286,936	38,491	8,227,609	37,308	11,759	508,534	9,496,430
2022	335,099	5,271	44,807	277,234	38,129	8,227,609	37,226	11,759	508,534	9,485,669
2023	335,099	5,271	44,382	273,014	37,956	8,227,609	37,184	11,759	508,534	9,480,807
2024	335,099	5,271	43,862	270,979	37,855	8,227,609	37,150	11,759	508,534	9,478,118
2025	335,099	5,271	43,300	268,667	37,714	8,227,609	37,108	11,759	508,534	9,475,061
2026	335,099	5,271	43,033	266,810	37,525	8,227,609	37,067	11,759	508,534	9,472,707
2027	335,099	5,271	42,391	264,107	37,239	8,227,609	37,006	11,759	508,534	9,469,014
2028	335,099	5,271	39,957	262,250	37,048	8,227,609	36,901	11,759	508,534	9,464,428
2029	335,099	5,271	39,643	259,489	36,713	8,227,609	36,834	11,759	508,534	9,460,951
2030	335,099	5,271	39,354	256,747	36,376	8,227,609	36,763	11,759	508,534	9,457,513
2031	335,099	5,271	37,768	240,358	34,435	8,227,609	36,355	11,759	508,534	9,437,188
2032	335,099	5,271	37,758	242,638	34,497	8,227,609	36,368	11,759	508,534	9,439,533
2033	335,099	5,271	37,422	238,397	33,828	8,227,609	36,235	11,759	508,534	9,434,155
2034	335,099	5,271	36,804	232,773	33,122	8,227,609	36,087	11,759	508,534	9,427,058
2035	335,099	5,271	36,076	224,892	31,963	8,227,609	35,851	11,759	508,534	9,417,054
<b>TOTAL</b>	<b>18,890,464</b>	<b>349,643</b>	<b>4,840,487</b>	<b>33,958,641</b>	<b>4,302,419</b>	<b>485,531,574</b>	<b>1,792,470</b>	<b>727,865</b>	<b>32,866,093</b>	<b>583,259,656</b>

d) Charges under Amendment No. 18 of the water supply contract with Kern County Water Agency.

**TABLE B-15. Capital Cost Component of Transportation Charge for Each Contractor**

(in dollars)

Sheet 3 of 4

Calendar Year	SOUTHERN CALIFORNIA AREA									
	Antelope Valley-East Kern Water Agency	Castaic Lake Water Agency	Coachella Valley Water District	Crestline-Lake Arrowhead Water Agency	Desert Water Agency	Littlerock Creek Irrigation District	Mojave Water Agency	Palmdale Water District	San Bernardino Valley Municipal Water District	San Gabriel Valley Municipal Water District
	[21]	[22]	[23]	[24]	[25]	[26]	[27]	[28]	[29]	[30]
1961	0	0	0	0	0	0	0	0	0	0
1962	0	0	0	0	0	0	0	0	0	0
1963	33,772	0	0	0	0	0	0	0	51,711	0
1964	63,539	27,438	16,286	4,368	37,145	1,142	28,427	8,202	82,782	34,973
1965	119,810	52,989	28,459	7,191	40,756	2,081	50,300	15,217	135,023	35,333
1966	217,978	101,232	51,184	12,474	73,129	3,752	90,369	27,670	232,426	61,445
1967	421,745	210,746	98,904	23,464	141,365	7,282	175,119	54,006	433,210	115,536
1968	678,696	419,656	164,991	38,538	231,834	11,777	286,745	87,265	729,615	194,465
1969	985,871	623,401	249,378	57,283	345,252	17,243	426,681	127,179	1,136,052	302,553
1970	1,287,604	780,247	352,336	84,769	487,182	23,419	592,710	171,243	1,690,922	443,566
1971	1,548,517	947,241	471,194	120,171	659,386	28,835	790,296	208,755	2,393,322	619,582
1972	1,682,260	1,056,774	533,559	137,410	749,360	31,296	897,414	226,425	2,807,612	720,574
1973	1,732,750	1,071,300	553,392	142,098	777,217	32,271	931,842	233,266	2,944,628	756,290
1974	1,751,139	1,117,943	562,610	146,284	790,534	32,592	944,315	235,613	3,034,266	776,838
1975	1,774,561	1,132,414	577,197	150,058	812,296	33,006	971,366	238,624	3,116,614	798,523
1976	1,787,687	1,145,045	587,768	152,747	828,555	33,258	991,635	240,355	3,194,699	819,292
1977	1,799,983	1,158,147	595,329	154,643	840,037	33,474	1,006,190	241,933	3,243,692	832,321
1978	1,810,314	1,177,197	600,379	155,959	847,711	33,666	1,016,056	243,300	3,273,805	840,240
1979	1,825,957	1,201,268	604,990	157,091	854,308	33,932	1,024,597	245,268	3,295,647	845,930
1980	1,844,482	1,249,214	609,777	158,201	861,177	34,236	1,033,618	247,529	3,316,194	851,450
1981	1,941,223	1,339,857	636,015	163,962	896,759	35,887	1,078,206	259,794	3,420,097	879,355
1982	1,932,976	1,371,097	632,062	163,511	892,804	35,756	1,073,517	258,797	3,412,772	877,137
1983	2,013,826	1,415,143	648,871	167,528	917,891	37,092	1,105,376	268,810	3,485,141	896,905
1984	2,120,889	1,441,789	670,984	173,418	951,144	38,859	1,142,891	282,045	3,593,400	926,520
1985	2,199,602	1,456,991	686,764	177,750	976,129	40,247	1,174,294	291,645	3,672,145	948,078
1986	2,246,108	1,465,218	698,218	180,934	994,360	40,914	1,206,078	297,120	3,729,014	963,621
1987	2,289,872	1,470,730	709,928	183,911	1,013,034	41,377	1,221,122	301,897	3,782,694	978,277
1988	2,307,280	1,476,302	718,732	186,176	1,027,137	41,664	1,239,161	303,993	3,823,044	989,254
1989	2,320,887	1,485,419	722,401	187,353	1,032,760	41,839	1,246,181	305,378	3,845,289	995,140
1990	2,376,181	1,508,162	741,616	192,411	1,060,538	42,713	1,280,418	311,911	3,916,996	1,014,533
1991	2,411,969	1,527,803	759,874	197,542	1,089,317	43,098	1,315,697	315,436	3,996,215	1,036,031
1992	2,456,111	1,549,043	779,790	203,932	1,121,316	43,730	1,354,452	320,331	4,100,806	1,064,576
1993	2,490,168	1,568,044	794,895	210,923	1,145,092	44,239	1,381,156	324,417	4,212,242	1,095,099
1994	2,524,639	1,585,861	807,651	220,102	1,164,765	44,786	1,400,119	328,384	4,418,688	1,151,256
1995	2,550,244	1,594,819	815,344	225,178	1,176,594	45,178	1,411,938	331,262	4,545,673	1,185,752
1996	2,575,637	1,610,822	823,318	229,455	1,188,534	45,584	1,424,617	334,239	4,652,614	1,214,705
1997	2,592,399	1,622,206	830,201	231,931	1,198,571	45,853	1,436,283	336,210	4,873,092	1,268,273
1998	2,617,017	1,636,089	836,569	233,300	1,208,050	46,264	1,461,054	339,238	5,029,853	1,290,351
1999	2,630,306	1,647,471	840,462	235,611	1,213,839	46,489	1,467,939	340,897	5,229,274	1,307,384
2000	2,645,666	2,801,213	845,895	237,886	1,222,202	46,762	1,978,325	404,727	5,540,513	1,320,729
2001	2,653,761	2,807,153	849,309	239,259	1,227,391	46,915	1,984,894	405,930	6,323,611	1,330,556
2002	2,677,971	2,810,445	852,412	240,168	1,232,263	47,089	1,991,191	407,204	7,443,770	1,336,151
2003	2,687,868	2,818,085	854,705	240,839	1,235,603	47,233	1,995,841	408,396	8,009,369	1,343,594
2004	2,685,195	2,818,005	859,379	240,966	1,235,895	47,185	1,996,431	408,096	8,233,772	1,345,220
2005	2,689,102	2,821,449	862,889	241,306	1,235,702	47,254	1,999,385	408,674	8,357,884	1,347,560
2006	2,700,629	2,830,865	868,361	242,040	2,008,056	47,452	2,005,409	410,352	8,416,680	1,351,305
2007	2,721,469	2,856,422	871,283	243,669	2,031,766	47,796	2,016,886	413,491	8,540,304	1,358,634
2008	2,738,746	2,875,673	879,966	245,269	2,054,938	48,094	2,027,301	416,074	8,673,819	1,366,383
2009	2,784,700	2,916,581	887,115	252,147	2,118,310	48,925	2,064,453	422,913	8,813,271	1,398,689
2010	2,848,127	2,976,963	892,408	261,613	2,385,184	50,093	2,137,466	432,336	8,995,747	1,445,281
2011	2,909,674	3,049,484	919,034	269,516	2,869,863	51,191	2,206,547	441,544	9,145,816	1,485,150
2012	2,922,236	3,060,900	920,296	270,671	2,879,455	51,417	2,214,823	443,395	9,170,496	1,491,563
2013	2,901,250	3,072,520	919,285	271,847	2,867,506	51,646	2,223,247	445,278	9,143,907	1,484,994
2014	2,877,370	3,043,740	919,617	268,020	2,855,571	50,610	2,194,238	437,247	9,124,403	1,479,822
2015	2,821,099	3,012,929	917,172	265,197	2,831,868	49,671	2,168,719	429,654	9,072,162	1,465,764
2016	2,722,931	2,955,813	917,186	259,915	2,788,519	48,000	2,121,256	416,066	8,974,758	1,439,652
2017	2,519,164	2,821,957	911,543	248,925	2,696,424	44,470	2,021,775	387,635	8,773,975	1,385,560
2018	2,262,213	2,534,235	911,226	233,850	2,572,003	39,974	1,884,243	350,425	8,477,570	1,306,631
2019	1,955,038	2,238,288	910,797	215,106	2,412,089	34,509	1,706,970	304,332	8,071,132	1,198,544
2020	1,653,305	2,007,651	910,277	187,620	2,213,828	28,333	1,499,923	253,417	7,516,262	1,057,530
2021	1,392,392	1,760,649	9,630,935	152,217	1,970,307	22,916	1,267,515	210,040	6,813,863	881,515
2022	1,258,649	1,601,165	8,736,891	134,979	1,767,993	20,455	1,142,184	189,197	6,399,573	780,343
2023	1,208,159	1,593,443	8,038,479	130,291	1,648,477	19,481	1,100,969	181,163	6,262,556	744,807
2024	1,189,770	1,534,588	7,923,941	126,105	1,620,934	19,160	1,086,058	178,353	6,172,919	724,259
2025	1,166,348	1,516,729	7,811,148	122,331	1,585,906	18,746	1,056,269	174,778	6,090,571	702,573
2026	1,153,222	1,498,487	7,708,554	119,642	1,557,218	18,493	1,034,569	172,759	6,012,486	681,805
2027	1,140,926	1,479,981	7,633,269	117,746	1,536,587	18,277	1,018,983	170,948	5,963,492	668,776
2028	1,130,595	1,452,154	7,596,756	116,429	1,524,664	18,086	1,008,689	169,432	5,933,380	660,857
2029	1,114,952	1,413,853	7,565,500	115,298	1,514,467	17,820	999,172	167,219	5,911,538	655,166
2030	1,096,427	1,336,664	7,540,005	114,188	1,504,801	17,516	989,156	164,706	5,890,991	649,647
2031	999,686	1,193,656	7,409,562	108,426	1,455,144	15,864	933,785	150,549	5,787,088	621,742
2032	1,007,933	1,142,167	7,419,651	108,878	1,459,928	15,996	942,807	152,180	5,794,413	623,599
2033	927,083	1,069,639	7,340,930	104,861	1,426,478	14,660	907,671	141,518	5,722,043	604,191
2034	820,020	1,027,416	7,231,633	98,971	1,381,435	12,893	862,228	127,534	5,613,784	574,576
2035	741,307	1,005,702	7,149,005	94,638	1,347,434	11,505	829,590	117,639	5,535,039	553,019
<b>TOTAL</b>	<b>137,688,981</b>	<b>122,001,781</b>	<b>299,745,374</b>	<b>12,408,504</b>	<b>98,682,089</b>	<b>2,431,319</b>	<b>94,297,144</b>	<b>19,618,851</b>	<b>377,574,230</b>	<b>67,997,885</b>

**TABLE B-15. Capital Cost Component of Transportation Charge for Each Contractor**

(in dollars)

Sheet 4 of 4

Calendar Year	SOUTHERN CALIFORNIA AREA (continued)				FEATHER RIVER AREA				South Bay Area Future Contractor	GRAND TOTAL
	San Geronio Pass Water Agency	The Metropolitan Water District of Southern California	Ventura County W.P. District	Total	City of Yuba City	County of Butte	Plumas County FC&WCD	Total		
	[31]	[32]	[33]	[34]	[35]	[36]	[37]	[38]	[39]	[40]
1961	0	0	0	0	0	0	0	0	0	0
1962	0	0	0	0	0	0	0	0	0	0
1963	0	690,539	0	776,021	0	0	0	0	0	1,400,081
1964	21,728	1,260,042	9,374	1,595,448	0	0	0	0	0	2,543,381
1965	21,859	2,179,810	17,760	2,706,589	0	0	405	405	0	4,279,539
1966	37,952	3,898,819	33,415	4,841,844	0	0	564	564	0	6,781,538
1967	71,260	7,691,085	68,133	9,511,856	0	0	562	562	0	11,921,674
1968	120,056	14,340,331	133,256	17,437,226	0	0	564	564	0	21,067,625
1969	187,000	21,850,137	202,534	26,510,563	0	0	3,190	3,190	0	31,181,777
1970	274,923	28,982,865	257,777	35,429,564	0	0	15,116	15,116	0	40,383,771
1971	384,903	37,229,879	316,207	45,718,288	0	0	15,942	15,942	0	51,095,831
1972	447,913	44,047,132	353,823	53,691,731	0	0	17,327	17,327	0	60,219,309
1973	470,035	46,283,635	357,228	56,285,951	0	0	17,327	17,327	0	62,820,117
1974	483,106	48,306,053	371,994	58,553,285	0	0	17,329	17,329	0	65,610,107
1975	496,565	49,268,119	376,391	59,745,733	0	0	17,331	17,331	0	67,481,703
1976	509,489	50,120,026	380,667	60,791,223	0	0	17,332	17,332	0	68,618,870
1977	517,576	50,809,655	384,975	61,617,957	0	0	17,335	17,335	0	69,793,648
1978	522,490	51,408,868	390,618	62,320,602	0	0	17,336	17,336	0	70,999,619
1979	526,011	52,212,368	399,522	63,226,889	0	0	17,338	17,338	0	72,441,921
1980	529,415	53,618,983	417,004	64,771,278	0	0	17,339	17,339	0	74,481,650
1981	546,614	56,648,010	449,669	68,295,448	0	0	17,341	17,341	0	78,625,065
1982	545,272	57,445,385	461,087	69,102,172	0	0	17,342	17,342	0	79,916,273
1983	557,430	59,017,274	477,181	71,008,468	0	0	17,343	17,343	0	82,041,088
1984	575,647	60,292,946	486,708	72,697,141	0	0	17,344	17,344	0	84,536,423
1985	588,902	61,123,708	491,961	73,828,217	0	0	17,345	17,345	0	86,359,949
1986	598,458	61,645,242	494,820	74,560,106	0	0	17,347	17,347	0	88,214,092
1987	607,471	62,073,455	496,600	75,170,368	0	0	17,348	17,348	0	91,064,243
1988	614,224	62,431,535	498,461	75,656,961	0	0	17,350	17,350	0	93,159,836
1989	617,863	62,774,747	501,420	76,076,677	0	0	17,353	17,353	0	94,383,976
1990	629,735	63,740,657	509,405	77,325,276	0	0	17,355	17,355	0	96,115,135
1991	642,915	64,655,258	515,983	78,507,138	0	0	17,358	17,358	0	97,689,011
1992	660,418	65,753,902	522,988	79,931,394	0	0	17,361	17,361	0	99,418,276
1993	679,129	66,882,231	529,216	81,356,851	0	0	17,363	17,363	0	101,119,366
1994	713,838	68,463,303	534,886	83,358,278	0	0	17,365	17,365	0	103,888,809
1995	735,201	69,349,936	537,642	84,504,760	0	0	17,366	17,366	0	107,813,277
1996	753,283	70,227,179	541,582	85,621,569	0	0	17,366	17,366	0	117,773,741
1997	813,865	71,506,673	544,296	87,299,852	0	0	17,366	17,366	0	128,037,605
1998	924,385	72,258,932	548,317	88,929,419	0	0	17,366	17,366	0	131,754,137
1999	1,112,663	72,892,733	552,010	90,017,078	0	0	17,366	17,366	0	133,503,517
2000	1,461,267	73,407,341	555,105	92,467,630	0	0	17,367	17,367	0	136,100,341
2001	2,438,239	73,717,086	556,484	94,580,587	0	0	17,368	17,368	0	139,079,194
2002	3,871,700	73,891,014	557,242	97,358,619	0	0	17,369	17,369	0	142,018,268
2003	4,575,618	74,203,116	559,292	98,979,559	0	0	17,370	17,370	0	144,177,908
2004	4,856,130	74,439,679	559,044	99,774,997	0	0	17,370	17,370	0	145,398,645
2005	5,000,750	68,332,606	559,850	100,322,412	0	0	17,370	17,370	0	146,338,586
2006	5,052,619	68,667,749	562,062	100,881,578	0	0	17,370	17,370	0	147,126,750
2007	5,170,362	69,398,864	567,662	102,081,609	0	0	17,370	17,370	0	148,748,454
2008	5,311,105	70,034,424	571,969	103,203,763	0	0	17,370	17,370	0	150,589,289
2009	5,331,252	71,614,206	581,377	105,462,632	0	0	17,370	17,370	0	154,752,302
2010	5,360,066	76,349,277	595,606	112,561,167	0	0	17,370	17,370	0	162,793,064
2011	5,384,616	84,618,864	612,937	125,024,237	0	0	17,370	17,370	0	175,718,014
2012	5,388,595	84,952,955	615,647	125,472,450	0	0	17,370	17,370	0	176,342,657
2013	5,384,496	84,672,631	618,405	125,118,013	0	0	17,370	17,370	0	175,522,274
2014	5,381,307	84,315,355	610,300	124,567,600	0	0	17,370	17,370	0	174,722,990
2015	5,372,651	83,446,959	601,914	123,410,757	0	0	16,966	16,966	0	172,933,940
2016	5,356,558	81,820,157	586,259	121,258,070	0	0	16,806	16,806	0	170,408,826
2017	5,323,251	78,228,319	551,541	116,546,829	0	0	16,808	16,808	0	165,220,516
2018	5,274,454	71,864,289	486,418	108,512,698	0	0	16,806	16,806	0	156,526,129
2019	5,207,510	64,745,080	417,140	99,303,519	0	0	14,180	14,180	0	146,900,683
2020	5,119,588	58,085,578	361,897	90,262,708	0	0	2,254	2,254	0	137,706,794
2021	5,009,607	50,437,675	303,468	79,853,100	0	0	1,428	1,428	0	127,245,443
2022	4,946,597	44,564,142	265,852	71,808,021	0	0	43	43	0	119,174,504
2023	4,924,475	43,097,633	262,447	69,212,380	0	0	43	43	0	116,530,505
2024	4,911,405	41,194,724	247,680	66,929,894	0	0	42	42	0	114,232,699
2025	4,897,946	40,344,093	243,283	65,730,723	0	0	39	39	0	113,005,579
2026	4,885,022	39,596,606	239,008	64,677,870	0	0	38	38	0	111,932,015
2027	4,876,934	38,983,825	234,699	63,844,444	0	0	36	36	0	111,068,404
2028	4,872,020	38,420,314	229,057	63,132,432	0	0	34	34	0	110,311,718
2029	4,868,499	37,647,047	220,153	62,210,685	0	0	32	32	0	109,353,454
2030	4,865,096	36,263,931	202,671	60,635,799	0	0	31	31	0	107,728,935
2031	4,847,896	33,353,147	170,005	57,046,550	0	0	30	30	0	104,020,744
2032	4,849,238	32,548,809	158,587	56,224,547	0	0	28	28	0	103,181,902
2033	4,837,080	31,047,172	142,493	54,285,822	0	0	27	27	0	101,158,059
2034	4,818,863	29,870,542	132,966	52,572,861	0	0	26	26	0	99,244,694
2035	4,805,609	29,115,521	127,714	51,433,720	0	0	25	25	0	97,754,969
<b>TOTAL</b>	<b>193,378,013</b>	<b>3,930,672,181</b>	<b>29,033,148</b>	<b>5,385,529,503</b>	<b>0</b>	<b>0</b>	<b>868,351</b>	<b>868,351</b>	<b>0</b>	<b>7,593,605,210</b>

**TABLE B-16A. Minimum OMP&R Component of  
Transportation Charge for Each Contractor**

(in dollars)

Sheet 1 of 4

Calendar Year	NORTH BAY AREA			SOUTH BAY AREA				CENTRAL COASTAL AREA		
	Napa County FC&WCD	Solano County WA	Total	Alameda County FC&WCD, Zone 7	Alameda County Water District	Santa Clara Valley Water District	Total	San Luis Obispo County FC&WCD	Santa Barbara County FC&WCD	Total
	[1]	[2]	[3]	[4]	[5]	[6]	[7]	[8]	[9]	[10]
1961	0	0	0	0	0	0	0	0	0	0
1962	0	0	0	9,699	8,868	21,132	39,699	0	0	0
1963	0	0	0	38,048	34,788	82,896	155,732	0	0	0
1964	0	0	0	41,148	38,323	91,320	170,791	0	0	0
1965	0	0	0	78,529	75,616	195,793	349,938	0	0	0
1966	0	0	0	79,753	78,779	218,543	377,075	0	0	0
1967	0	0	0	127,896	123,667	335,224	586,787	0	0	0
1968	130	0	130	126,058	120,563	333,506	580,127	11,800	21,770	33,570
1969	80,875	0	80,875	145,411	138,050	372,585	656,046	63,113	116,435	179,548
1970	94,872	0	94,872	128,993	120,245	320,664	569,902	74,187	136,867	211,054
1971	45,579	0	45,579	113,071	108,346	296,004	517,421	74,011	136,541	210,552
1972	37,895	0	37,895	122,407	117,483	334,366	574,256	79,196	146,107	225,303
1973	32,993	0	32,993	122,738	116,785	325,726	565,249	75,714	139,683	215,397
1974	46,498	0	46,498	154,435	146,929	403,080	704,444	76,530	141,189	217,719
1975	37,707	0	37,707	189,175	182,087	513,823	885,085	92,605	170,845	263,450
1976	60,786	0	60,786	203,064	193,435	524,813	921,312	94,935	175,144	270,079
1977	78,400	0	78,400	179,869	169,065	500,101	849,035	102,945	189,922	292,867
1978	56,318	0	56,318	239,301	228,855	647,828	1,115,984	104,060	191,978	296,038
1979	73,852	0	73,852	236,986	232,105	666,742	1,135,833	100,748	185,868	286,616
1980	81,769	0	81,769	389,575	372,185	1,010,830	1,772,590	126,328	233,105	359,433
1981	101,340	0	101,340	317,408	302,272	834,257	1,453,937	140,208	258,712	398,920
1982	191,987	0	191,987	386,742	369,633	1,098,844	1,855,219	142,045	262,101	404,146
1983	80,215	0	80,215	438,536	428,973	1,269,373	2,136,882	171,001	315,523	486,524
1984	106,485	0	106,485	591,243	565,721	1,817,629	2,974,593	201,768	372,284	574,052
1985	215,341	0	215,341	674,975	655,490	1,840,211	3,170,676	242,935	448,233	691,168
1986	203,704	0	203,704	613,273	583,077	1,784,056	2,980,406	233,000	429,904	662,904
1987	295,505	0	295,505	687,629	652,468	2,000,817	3,340,914	230,484	463,838	694,322
1988	312,677	(58)	312,619	676,847	655,274	1,910,092	3,242,213	258,807	561,030	819,837
1989	403,330	688,185	1,091,515	716,831	712,354	1,897,149	3,326,334	244,772	668,476	913,248
1990	658,942	674,944	1,333,886	782,589	780,305	2,129,966	3,692,860	310,222	677,025	987,247
1991	726,717	860,903	1,587,620	543,178	524,741	1,520,569	2,588,488	302,369	673,858	976,227
1992	483,580	712,313	1,195,893	796,058	855,050	2,255,496	3,904,604	346,220	736,477	1,082,697
1993	524,000	708,129	1,232,129	1,280,736	1,261,431	3,338,742	5,880,909	386,060	734,138	1,120,198
1994	573,814	658,274	1,232,088	1,368,665	1,312,746	3,560,310	6,241,721	481,022	888,287	1,379,309
1995	539,407	660,770	1,200,177	1,232,272	1,187,201	3,216,470	5,635,943	477,929	881,323	1,359,252
1996	604,992	1,011,298	1,616,290	1,185,220	1,124,968	3,007,330	5,317,518	649,161	1,197,179	1,846,340
1997	563,579	741,881	1,305,460	1,029,670	968,999	2,667,649	4,666,318	466,652	749,805	1,156,457
1998	461,844	661,193	1,123,037	1,064,729	1,174,897	3,502,733	5,742,359	810,087	3,051,492	3,861,579
1999	609,450	1,001,213	1,610,663	1,228,573	1,269,683	5,091,354	7,589,610	791,990	3,082,117	3,874,107
2000	782,045	1,507,425	2,289,470	2,191,139	1,311,055	3,791,672	7,293,866	723,721	3,446,638	4,170,359
2001	659,666	1,464,187	2,123,853	4,228,437	1,059,723	3,595,796	8,883,956	746,317	3,127,544	3,873,861
2002	1,110,403	1,899,666	3,010,069	8,308,048	1,383,503	6,121,568	15,813,119	6,123,325	3,588,037	4,373,362
2003	1,180,894	2,274,096	3,454,990	4,946,504	1,081,677	3,606,278	9,634,459	832,092	3,747,948	4,580,040
2004	1,630,931	2,372,362	4,003,293	2,629,456	1,302,760	3,590,398	7,522,614	835,402	3,751,509	4,586,911
2005	925,270	1,819,227	2,744,497	2,413,301	1,140,692	2,973,713	6,527,706	883,546	4,205,791	5,089,337
2006	810,347	1,387,455	2,197,802	2,421,089	1,150,371	3,151,320	6,722,780	803,260	4,275,639	5,078,899
2007	999,508	2,150,118	3,149,626	3,008,876	1,454,161	3,745,680	8,208,717	999,451	5,182,387	6,181,838
2008	973,790	1,763,729	2,737,519	3,052,920	1,418,398	3,810,019	8,281,337	1,002,784	4,555,562	5,558,347
2009	1,041,809	1,877,752	2,919,561	3,332,396	1,541,992	4,158,722	9,033,110	1,085,323	4,966,717	6,052,040
2010	1,007,519	1,841,091	2,848,610	3,195,546	1,486,031	4,089,710	8,771,287	1,011,901	4,661,687	5,673,588
2011	994,157	1,628,696	2,622,853	3,252,125	1,578,772	4,400,349	9,231,246	908,647	3,411,092	4,319,739
2012	994,390	1,629,120	2,623,510	3,252,790	1,579,065	4,401,148	9,233,003	908,843	3,411,880	4,320,723
2013	995,005	1,630,402	2,625,407	3,254,177	1,579,527	4,402,312	9,236,016	909,314	3,413,985	4,323,299
2014	995,303	1,631,333	2,626,636	3,254,273	1,579,235	4,401,292	9,234,800	909,474	3,415,088	4,324,562
2015	996,050	1,632,548	2,628,598	3,256,676	1,580,423	4,404,621	9,241,720	910,136	3,417,572	4,327,708
2016	994,798	1,630,383	2,625,181	3,252,898	1,578,654	4,399,723	9,231,275	909,056	3,413,371	4,322,427
2017	995,303	1,631,282	2,626,585	3,254,363	1,579,318	4,401,549	9,235,230	909,483	3,415,064	4,324,547
2018	996,021	1,632,788	2,628,809	3,255,996	1,579,863	4,402,919	9,238,778	910,037	3,417,537	4,327,574
2019	994,715	1,630,443	2,625,158	3,252,232	1,578,172	4,398,283	9,228,687	908,932	3,413,135	4,322,067
2020	995,601	1,631,819	2,627,420	3,255,206	1,579,692	4,402,572	9,237,470	909,733	3,416,067	4,325,800
2021	996,087	1,632,470	2,628,557	3,257,029	1,580,698	4,405,451	9,243,178	910,194	3,417,645	4,327,839
2022	995,804	1,632,396	2,628,200	3,255,367	1,579,582	4,402,148	9,237,097	909,852	3,416,799	4,326,651
2023	994,877	1,630,482	2,625,359	3,253,191	1,578,819	4,400,195	9,232,205	909,128	3,413,617	4,322,745
2024	995,248	1,631,285	2,626,533	3,253,988	1,579,058	4,400,774	9,233,820	909,409	3,414,897	4,324,306
2025	996,285	1,632,938	2,629,223	3,257,386	1,580,764	4,405,570	9,243,720	910,336	3,418,342	4,328,678
2026	994,428	1,629,969	2,624,397	3,251,324	1,577,731	4,397,048	9,226,103	908,679	3,412,177	4,320,856
2027	997,641	1,635,120	2,632,761	3,261,772	1,582,944	4,411,684	9,256,400	911,541	3,422,844	4,334,385
2028	994,329	1,629,886	2,624,215	3,250,848	1,577,434	4,396,185	9,224,467	908,572	3,411,861	4,320,433
2029	995,662	1,631,854	2,627,516	3,255,535	1,579,905	4,403,198	9,238,638	909,804	3,416,261	4,326,065
2030	994,715	1,630,193	2,624,908	3,252,718	1,579,604	4,399,605	9,230,927	908,991	3,413,074	4,322,065
2031	997,931	1,635,852	2,633,783	3,262,190	1,582,950	4,411,578	9,256,718	911,734	3,423,866	4,335,600
2032	993,767	1,628,989	2,622,756	3,249,019	1,576,520	4,393,617	9,219,156	908,971	3,409,999	4,318,070
2033	995,796	1,631,925	2,627,721	3,256,248	1,580,369	4,404,563	9,241,180	909,057	3,416,662	4,326,619
2034	995,960	1,632,443	2,628,403	3,256,289	1,580,198	4,403,969	9,240,456	910,043	3,417,275	4,327,318
2035	993,906	1,629,200	2,623,106	3,249,497	1,576,767	4,394,315	9,220,579	908,198	3,410,461	4,318,659
<b>TOTAL</b>	<b>44,390,544</b>	<b>69,519,969</b>	<b>113,910,513</b>	<b>139,432,178</b>	<b>71,806,884</b>	<b>204,615,567</b>	<b>415,854,630</b>	<b>40,350,190</b>	<b>149,327,286</b>	<b>189,677,477</b>

**TABLE B-16A. Minimum OMP&R Component of Transportation Charge for Each Contractor**

(in dollars)

Sheet 2 of 4

Calendar Year	SAN JOAQUIN VALLEY AREA								
	Dudley Ridge Water District	Empire West Side Irrigation District	Future Contractor San Joaquin Valley	Kern County Water Agency		County of Kings	Oak Flat Water District	Tulare Lake Basin Water Storage District	Total
				Municipal and Industrial	Agricultural				
	[11]	[12]	[13]	[14]	[15]	[16]	[17]	[18]	[19]
1961	0	0	0	0	0	0	0	0	0
1962	0	0	0	0	0	0	0	0	0
1963	0	0	0	0	0	0	0	0	0
1964	0	0	0	0	0	0	0	0	0
1965	0	0	0	0	0	0	0	0	0
1966	0	0	0	0	0	0	0	0	0
1967	0	0	0	0	0	0	0	0	0
1968	37,806	1,963	5,639	60,701	678,086	2,008	2,073	77,591	865,867
1969	45,479	2,235	30,158	80,554	1,197,126	2,286	2,085	90,773	1,450,696
1970	46,969	2,292	35,450	96,673	1,381,493	2,344	2,158	93,408	1,660,787
1971	47,997	2,314	35,366	106,654	1,643,163	2,366	2,288	94,874	1,935,022
1972	49,866	2,414	37,844	122,313	1,729,169	2,469	2,254	98,777	2,045,106
1973	50,006	2,385	36,180	125,553	1,719,873	2,440	2,310	98,330	2,037,077
1974	52,818	2,556	36,570	135,661	1,823,065	2,614	2,529	104,609	2,160,422
1975	66,963	3,243	44,251	162,738	2,235,242	3,317	3,191	132,663	2,651,608
1976	66,504	3,328	45,364	159,303	2,215,999	3,404	2,919	133,940	2,630,761
1977	75,595	3,812	49,192	189,661	2,522,290	3,898	3,708	152,838	3,000,994
1978	70,688	3,503	49,725	174,897	2,427,163	3,583	3,644	141,672	2,874,875
1979	68,879	3,436	48,142	173,677	2,378,315	3,514	3,492	138,493	2,817,948
1980	95,898	4,722	59,551	235,741	3,146,570	4,830	4,777	191,582	3,743,671
1981	118,448	5,965	66,183	266,353	3,440,557	6,099	5,187	239,323	4,148,115
1982	134,083	6,711	67,061	311,879	3,848,922	6,862	6,382	270,061	4,651,961
1983	184,902	9,242	80,869	426,485	5,030,031	9,450	8,494	372,182	6,121,655
1984	194,228	9,656	95,555	471,854	5,636,134	9,874	8,719	389,892	6,815,912
1985	200,694	9,957	115,227	486,162	6,042,593	10,182	8,982	402,457	7,276,254
1986	207,028	10,302	110,479	530,803	6,372,710	10,536	10,341	415,776	7,667,975
1987	205,002	10,259	109,401	533,451	6,378,437	10,493	10,517	412,889	7,670,449
1988	203,711	10,223	122,903	516,432	6,388,497	10,455	10,341	410,868	7,673,430
1989	224,049	11,269	116,197	564,169	6,747,046	11,526	11,102	452,406	8,137,764
1990	271,051	13,666	148,238	664,040	8,111,616	13,976	13,206	547,974	9,783,767
1991	275,748	13,854	144,486	662,755	8,111,610	14,168	13,218	556,474	9,792,313
1992	317,889	16,027	162,466	764,224	9,115,453	16,393	18,209	642,672	11,053,333
1993	359,879	17,989	184,477	831,662	10,372,245	18,399	19,560	724,397	12,528,608
1994	309,084	15,486	224,254	738,619	9,789,833	15,839	16,434	622,879	11,732,428
1995	395,441	19,918	220,899	898,339	11,190,121	20,373	21,551	799,070	13,565,712
1996	362,623	19,968	301,835	902,162	11,872,821	20,424	21,664	796,711	14,298,208
1997	366,476	20,154	186,450	942,987	10,558,144	20,613	19,344	806,084	12,920,252
1998	453,027	24,560	288,906	1,098,213	12,207,859	25,122	21,594	995,194	15,114,476
1999	378,699	20,889	272,342	984,246	10,924,358	21,364	21,511	832,731	13,556,140
2000	383,439	21,089	207,531	1,069,880	9,937,608	21,569	22,694	841,923	12,505,732
2001	462,404	25,444	231,676	1,280,623	11,239,895	26,023	31,679	1,015,604	14,313,348
2002	425,710	21,551	224,731	1,160,115	10,228,485	22,041	25,564	812,862	12,921,059
2003	492,395	25,086	242,311	1,253,230	11,230,255	25,658	30,576	940,332	14,239,843
2004	452,017	23,155	246,564	1,216,248	10,795,591	63,079	25,920	748,385	13,570,958
2005	425,522	21,844	259,203	1,038,362	10,303,872	59,430	24,277	705,461	12,837,971
2006	487,041	24,667	203,549	1,164,467	10,806,481	74,532	26,184	795,800	13,582,721
2007	513,644	26,006	248,823	1,269,512	11,727,029	81,237	25,894	842,923	14,735,067
2008	688,067	35,232	290,795	1,653,236	15,132,788	106,989	34,673	1,134,160	19,075,940
2009	819,516	39,151	322,005	1,763,708	17,304,616	117,801	35,955	1,259,903	21,662,655
2010	736,407	35,086	310,094	1,463,925	15,715,459	106,485	31,348	1,130,201	19,529,005
2011	520,696	24,105	317,137	1,178,213	12,989,543	78,005	27,505	784,817	15,920,021
2012	520,817	24,110	317,206	1,178,491	12,992,574	78,023	27,509	784,998	15,923,728
2013	521,222	24,129	317,381	1,179,360	13,001,783	78,081	27,520	785,603	15,935,079
2014	521,574	24,145	317,452	1,180,036	13,008,548	78,128	27,525	786,128	15,943,536
2015	521,886	24,159	317,682	1,180,804	13,017,148	78,176	27,540	786,596	15,953,991
2016	521,296	24,132	317,303	1,179,409	13,001,762	78,088	27,515	785,714	15,935,219
2017	521,547	24,144	317,454	1,179,991	13,008,141	78,125	27,525	786,088	15,943,015
2018	522,022	24,166	317,659	1,181,013	13,018,956	78,193	27,538	786,798	15,956,345
2019	521,362	24,135	317,267	1,179,486	13,002,264	78,095	27,513	785,812	15,935,934
2020	521,699	24,151	317,542	1,180,343	13,011,975	78,148	27,531	786,317	15,947,706
2021	521,831	24,157	317,698	1,180,726	13,016,511	78,170	27,541	786,515	15,953,149
2022	521,910	24,160	317,593	1,180,755	13,016,141	78,176	27,534	786,631	15,952,900
2023	521,314	24,133	317,327	1,179,464	13,002,419	78,091	27,517	785,740	15,936,005
2024	521,572	24,145	317,432	1,180,013	13,008,210	78,128	27,524	786,127	15,943,151
2025	521,988	24,164	317,752	1,181,050	13,019,878	78,192	27,544	786,749	15,957,317
2026	521,237	24,130	317,179	1,179,183	12,998,887	78,076	27,508	785,625	15,931,825
2027	522,548	24,190	318,170	1,182,431	13,035,369	78,278	27,571	787,586	15,976,143
2028	521,235	24,130	317,144	1,179,145	12,998,318	78,074	27,505	785,622	15,931,173
2029	521,692	24,150	317,565	1,180,352	13,012,198	78,147	27,532	786,305	15,947,941
2030	521,234	24,129	317,278	1,179,277	13,000,377	78,079	27,514	785,620	15,933,508
2031	522,803	24,201	318,246	1,182,946	13,040,659	78,313	27,576	787,967	15,982,711
2032	521,007	24,119	316,971	1,178,579	12,991,958	78,039	27,494	785,281	15,923,448
2033	521,672	24,150	317,612	1,180,367	13,012,630	78,147	27,535	786,277	15,948,390
2034	521,869	24,159	317,652	1,180,745	13,016,404	78,173	27,538	786,571	15,953,111
2035	521,059	24,121	317,015	1,178,712	12,993,470	78,047	27,497	785,358	15,925,279
<b>TOTAL</b>	<b>24,862,783</b>	<b>1,206,223</b>	<b>14,255,659</b>	<b>58,253,158</b>	<b>636,874,742</b>	<b>2,969,257</b>	<b>1,306,699</b>	<b>42,119,989</b>	<b>781,848,511</b>

**TABLE B-16A. Minimum OMP&R Component of Transportation Charge for Each Contractor**

(in dollars)

Sheet 3 of 4

Calendar Year	SOUTHERN CALIFORNIA AREA									
	Antelope Valley-East Kern Water Agency	Castaic Lake Water Agency	Coachella Valley Water District	Crestline-Lake Arrowhead Water Agency	Desert Water Agency	Littlerock Creek Irrigation District	Mojave Water Agency	Palmdale Water District	San Bernardino Valley Municipal Water District	San Gabriel Valley Municipal Water District
	[20]	[21]	[22]	[23]	[24]	[25]	[26]	[27]	[28]	[29]
1961	0	0	0	0	0	0	0	0	0	0
1962	0	0	0	0	0	0	0	0	0	0
1963	0	0	0	0	0	0	0	0	0	0
1964	0	0	0	0	0	0	0	0	0	0
1965	0	0	0	0	0	0	0	0	0	0
1966	0	0	0	0	0	0	0	0	0	0
1967	0	0	0	0	0	0	0	0	0	0
1968	65,074	28,085	11,697	2,958	19,291	1,089	24,380	8,173	52,315	14,399
1969	86,339	70,342	15,522	3,925	25,598	1,445	32,348	10,844	69,419	19,106
1970	107,807	84,577	19,392	4,904	31,981	1,804	40,391	13,540	86,727	23,865
1971	178,820	105,979	32,228	8,150	53,151	2,992	66,999	22,459	144,136	39,636
1972	363,555	202,625	106,740	30,967	176,037	6,601	213,032	48,102	548,123	144,113
1973	404,661	222,765	121,341	34,674	200,116	7,346	243,320	53,975	724,535	190,156
1974	434,868	235,528	130,627	37,062	215,432	7,677	262,735	56,383	786,107	207,019
1975	504,791	289,501	151,031	43,176	249,082	9,082	303,108	65,580	905,424	238,842
1976	559,013	262,420	160,686	44,454	265,004	10,030	325,512	73,253	964,524	256,570
1977	675,504	335,749	184,813	47,743	304,792	11,890	381,161	87,355	1,069,446	289,793
1978	600,343	376,946	187,028	54,156	308,449	10,711	373,192	78,304	1,148,279	300,751
1979	661,123	349,072	196,264	52,211	323,677	12,124	401,469	87,126	1,125,452	302,508
1980	858,039	415,571	253,090	71,921	417,398	15,435	508,379	112,853	1,518,405	401,223
1981	1,001,503	511,087	284,970	73,534	469,970	18,046	588,024	131,992	1,548,350	420,523
1982	1,128,643	557,494	320,938	89,560	529,292	20,193	649,204	148,012	1,870,559	497,871
1983	1,744,932	832,687	450,049	119,275	742,218	30,643	922,072	225,793	2,373,149	639,682
1984	2,105,780	943,524	548,784	150,179	905,055	36,810	1,112,196	271,187	3,018,294	803,394
1985	2,157,936	1,055,744	584,697	157,841	964,282	38,972	1,191,309	277,250	3,230,403	860,780
1986	2,311,841	1,102,466	618,750	162,748	1,020,438	40,051	1,268,806	295,987	3,318,638	893,069
1987	2,366,343	1,032,918	628,222	167,262	1,036,061	41,773	1,283,836	307,844	3,400,838	913,933
1988	2,303,274	1,042,113	649,276	175,694	1,070,784	40,604	1,321,553	298,438	3,587,873	960,968
1989	2,280,051	1,088,176	613,266	169,993	1,011,401	39,501	1,240,888	292,775	3,499,964	932,519
1990	2,636,186	1,275,150	708,829	201,242	1,169,006	45,472	1,424,445	336,069	4,084,211	1,078,392
1991	2,737,441	1,454,172	763,989	210,644	1,259,974	48,936	1,546,583	358,165	4,348,900	1,150,633
1992	2,781,586	1,579,025	750,248	198,232	1,237,307	49,829	1,538,733	362,844	4,131,745	1,115,632
1993	3,109,819	1,689,775	850,589	234,719	1,402,796	56,125	1,722,415	411,539	5,023,595	1,338,111
1994	2,825,193	1,608,731	794,991	225,121	1,311,100	51,259	1,634,886	376,180	4,794,820	1,267,565
1995	3,121,440	1,720,649	848,101	231,718	1,398,686	58,749	1,766,297	444,998	4,828,432	1,272,345
1996	3,093,678	1,966,634	862,720	228,008	1,422,789	56,813	1,817,427	423,444	4,707,473	1,256,549
1997	3,250,394	1,810,292	918,428	281,067	1,514,687	59,547	1,853,224	446,127	5,705,741	1,477,757
1998	3,876,512	2,050,254	1,070,517	299,639	1,765,491	73,835	3,207,848	561,246	6,076,375	1,634,942
1999	3,780,333	2,086,762	1,098,033	309,072	1,810,872	74,297	3,189,523	541,407	6,405,298	1,722,795
2000	3,803,720	3,416,157	1,035,666	293,799	1,708,021	68,473	3,027,894	601,247	5,910,681	1,581,728
2001	4,532,166	3,819,998	1,110,674	300,980	1,831,713	80,824	3,325,217	711,095	5,807,360	1,570,048
2002	3,725,095	3,552,292	1,018,470	286,101	1,679,659	62,597	3,048,009	562,582	5,696,607	1,529,203
2003	4,143,946	3,442,873	1,121,431	301,757	1,849,452	67,903	3,334,398	620,116	6,515,607	1,602,976
2004	4,535,547	4,096,899	1,445,754	326,899	2,121,402	76,867	3,478,010	690,320	7,258,382	1,978,203
2005	4,244,762	3,676,378	6,268,619	307,697	2,402,289	73,020	3,073,062	632,862	7,106,595	1,684,260
2006	3,965,679	3,425,064	8,167,220	318,778	2,787,628	70,261	3,173,450	616,236	7,186,858	1,745,140
2007	4,003,402	4,393,933	8,197,434	334,713	2,792,195	69,188	3,264,745	610,242	8,603,792	1,896,270
2008	5,378,608	4,914,156	10,744,364	408,042	3,570,615	92,102	4,136,538	824,138	9,200,189	2,223,764
2009	5,674,164	5,175,963	10,859,768	435,170	3,724,597	97,201	4,403,074	869,197	10,006,331	2,404,264
2010	5,224,802	4,850,563	10,742,916	420,527	3,651,716	92,545	4,154,137	797,369	9,658,703	2,366,641
2011	4,494,107	4,154,762	7,980,690	331,155	2,837,060	79,600	3,552,318	690,027	7,809,996	1,858,718
2012	4,495,390	4,149,135	8,043,745	326,340	2,840,132	79,626	3,553,496	690,234	7,724,638	1,842,242
2013	4,499,711	4,168,931	8,127,589	313,179	2,837,324	79,723	3,557,935	690,959	7,491,073	1,797,378
2014	4,503,534	4,159,937	8,039,288	338,306	2,859,058	79,823	3,562,505	691,641	7,937,415	1,885,220
2015	4,506,755	4,157,337	8,090,516	313,853	2,836,601	79,879	3,565,039	692,133	7,503,690	1,800,954
2016	4,500,673	4,173,737	8,015,342	341,621	2,858,715	79,764	3,559,825	691,177	7,995,904	1,896,224
2017	4,503,294	4,169,112	8,219,627	323,806	2,865,233	79,816	3,562,164	691,595	7,679,780	1,834,898
2018	4,508,334	4,170,028	8,052,765	328,886	2,851,538	79,929	3,567,335	692,440	7,770,448	1,853,403
2019	4,501,494	4,185,009	8,263,765	341,580	2,893,103	79,793	3,561,198	691,348	7,994,829	1,896,267
2020	4,504,902	4,180,421	7,939,687	325,005	2,829,560	79,848	3,563,633	691,854	7,701,357	1,839,328
2021	4,506,185	4,150,804	8,031,710	310,336	2,823,744	79,860	3,564,152	692,020	7,441,385	1,788,638
2022	4,507,234	4,152,455	8,390,969	326,528	2,893,882	79,908	3,566,365	692,266	7,728,349	1,845,047
2023	4,500,884	4,160,938	8,065,812	340,857	2,864,583	79,766	3,559,918	691,205	7,982,447	1,893,605
2024	4,503,652	4,193,732	8,159,670	323,812	2,857,571	79,829	3,562,813	691,673	7,679,700	1,835,003
2025	4,507,871	4,128,510	7,919,908	326,891	2,830,118	79,900	3,565,988	692,309	7,735,655	1,846,346
2026	4,500,243	4,191,747	8,382,417	342,524	2,909,921	79,771	3,560,201	691,156	8,011,276	1,899,336
2027	4,513,591	4,052,078	7,812,658	321,922	2,811,093	79,999	3,570,421	693,180	7,648,930	1,830,033
2028	4,500,241	4,316,175	8,096,032	310,638	2,831,929	79,777	3,560,466	691,172	7,444,377	1,788,798
2029	4,504,817	4,112,370	8,114,392	340,264	2,871,862	79,842	3,563,347	691,827	7,972,690	1,892,204
2030	4,500,061	4,120,952	8,134,814	341,550	2,874,450	79,750	3,559,189	691,074	7,994,613	1,895,872
2031	4,516,362	4,056,776	8,370,526	302,953	2,864,565	80,067	3,573,539	693,662	7,311,823	1,764,776
2032	4,497,906	4,313,389	7,898,690	339,586	2,840,528	79,737	3,558,678	690,818	7,958,179	1,888,794
2033	4,504,546	4,124,240	8,165,725	320,214	2,853,396	79,826	3,562,614	691,754	7,616,714	1,822,610
2034	4,506,683	4,163,481	8,076,531	317,421	2,839,286	79,882	3,565,174	692,135	7,566,941	1,813,329
2035	4,498,484	4,192,366	8,437,850	362,106	2,941,434	79,746	3,559,112	690,905	8,358,582	1,966,968
<b>TOTAL</b>	<b>215,931,667</b>	<b>177,289,511</b>	<b>278,478,890</b>	<b>16,067,645</b>	<b>123,959,190</b>	<b>3,826,123</b>	<b>159,931,254</b>	<b>32,055,212</b>	<b>362,109,446</b>	<b>89,313,929</b>

**TABLE B-16A. Minimum OMP&R Component of Transportation Charge for Each Contractor**

(in dollars)

Sheet 4 of 4

Calendar Year	SOUTHERN CALIFORNIA AREA (continued)				FEATHER RIVER AREA				South Bay Area Future Contractor	GRAND TOTAL
	San Gorgonio Pass Water Agency	The Metropolitan Water District of Southern California	Ventura County W.P. District	Total	City of Yuba City	County of Butte	Plumas County FC&WCD	Total		
1961	[30] 0	[31] 0	[32] 0	[33] 0	[34] 0	[35] 0	[36] 0	[37] 0	[38] 0	[39] 0
1962	0	0	0	0	0	0	0	0	3,219	42,918
1963	0	0	0	0	0	0	0	0	12,626	168,358
1964	0	0	0	0	0	0	0	0	13,938	184,729
1965	0	0	0	0	0	0	0	0	28,937	378,875
1966	0	0	0	0	0	0	0	0	31,321	408,396
1967	0	0	0	0	0	0	0	0	47,718	634,505
1968	8,821	972,734	9,504	1,218,520	0	0	0	0	46,945	2,745,159
1969	11,704	1,295,607	12,610	1,654,809	0	0	0	0	52,963	4,074,937
1970	14,623	1,624,569	15,746	2,069,926	0	0	0	0	69,744	4,676,285
1971	24,302	2,716,584	26,118	3,421,554	0	0	54	54	55,532	6,185,714
1972	89,131	8,038,463	68,369	10,035,858	0	0	40	40	80,412	12,998,870
1973	117,779	9,890,316	78,313	12,289,297	0	0	1	1	54,219	15,194,233
1974	128,169	11,581,491	83,453	14,166,551	0	0	143	143	76,783	17,372,560
1975	147,899	13,584,548	101,893	16,593,957	0	0	1,069	1,069	84,547	20,517,423
1976	158,664	12,862,489	94,799	16,037,418	0	0	139	139	106,717	20,027,212
1977	178,774	16,203,699	121,966	19,892,685	0	0	892	892	98,618	24,213,491
1978	186,384	17,811,770	132,435	21,568,748	0	0	39	39	100,786	26,012,788
1979	186,688	16,414,289	126,756	20,238,759	0	0	3,235	3,235	119,352	24,675,595
1980	248,399	20,926,898	154,096	25,901,707	0	0	416	416	178,812	32,038,398
1981	259,244	23,731,024	186,592	29,224,859	0	0	3,847	3,847	185,347	35,516,365
1982	307,955	27,994,510	209,141	34,323,372	0	0	11,075	11,075	173,894	41,611,654
1983	394,524	38,953,367	326,258	47,754,649	0	0	1,928	1,928	220,926	56,802,779
1984	496,808	45,597,671	382,104	56,371,786	0	0	3,765	3,765	225,959	67,072,552
1985	531,765	50,064,444	416,652	61,532,075	0	0	2,888	2,888	340,322	73,228,724
1986	551,066	52,858,915	442,334	64,885,109	0	0	2,787	2,787	279,227	76,682,112
1987	564,352	50,737,631	411,276	62,892,289	0	0	2,388	2,388	345,116	75,240,983
1988	593,787	51,262,231	406,248	63,712,843	0	0	545	545	365,207	76,126,694
1989	576,852	52,638,942	431,020	64,815,348	0	0	1,800	1,800	422,329	78,708,338
1990	667,687	61,053,824	494,721	75,175,234	0	0	788	788	474,284	91,448,066
1991	711,803	60,874,529	470,139	75,935,908	0	0	3,654	3,654	214,683	91,098,893
1992	688,558	67,460,598	502,131	82,396,468	0	0	647	647	443,676	100,077,318
1993	828,208	68,749,547	538,751	85,955,989	0	0	3,630	3,630	599,571	107,321,034
1994	783,691	63,898,029	473,897	80,045,463	0	0	2,279	2,279	609,966	101,233,254
1995	785,191	68,079,888	523,512	85,080,006	0	0	2,906	2,906	534,971	107,378,967
1996	773,653	72,757,439	561,100	89,927,727	0	0	8,007	8,007	571,857	113,585,947
1997	917,372	75,655,465	564,455	94,454,556	0	0	7,449	7,449	428,638	114,939,130
1998	1,000,558	80,540,695	608,294	102,766,206	0	0	0	0	465,095	129,072,752
1999	1,055,217	85,194,217	628,098	107,895,924	0	0	0	0	559,471	134,985,915
2000	965,146	83,200,802	635,833	106,249,167	0	0	0	0	0	132,508,594
2001	950,957	93,944,025	708,297	118,693,354	0	0	0	0	0	147,888,372
2002	925,783	86,537,495	657,014	109,280,907	0	0	0	0	0	145,398,516
2003	1,311,937	83,423,547	619,998	108,355,941	0	0	3,393	3,393	0	140,268,666
2004	1,407,010	100,690,565	762,853	128,449,711	0	0	3,455	3,455	0	158,136,942
2005	1,607,128	77,834,448	676,165	109,587,285	0	0	3,452	3,452	0	136,790,248
2006	1,436,019	80,723,921	640,473	114,256,727	0	0	3,979	3,979	0	141,842,908
2007	2,057,796	104,080,761	856,925	141,161,396	0	0	3,955	3,955	0	173,440,599
2008	1,901,975	114,735,040	926,261	159,055,793	0	0	3,213	3,213	0	194,712,148
2009	2,048,397	118,416,632	964,315	165,079,073	0	0	1,836	1,836	0	204,748,275
2010	2,011,588	113,337,015	928,203	158,236,725	0	0	1,926	1,926	0	195,061,141
2011	1,700,463	92,298,988	775,292	128,563,176	0	0	4,704	4,704	0	160,661,739
2012	1,689,642	92,011,947	773,735	128,220,302	0	0	4,704	4,704	0	160,325,970
2013	1,660,146	92,089,272	778,755	128,091,975	0	0	4,704	4,704	0	160,216,480
2014	1,717,598	92,816,206	776,280	129,366,811	0	0	4,703	4,703	0	161,501,048
2015	1,662,333	91,631,430	775,364	127,615,884	0	0	4,705	4,705	0	159,772,606
2016	1,724,865	93,368,180	780,076	129,986,103	0	0	4,702	4,702	0	162,104,907
2017	1,684,632	92,751,501	778,700	129,144,158	0	0	4,703	4,703	0	161,278,238
2018	1,696,644	92,641,056	778,710	128,991,516	0	0	4,704	4,704	0	161,147,726
2019	1,724,857	94,184,644	783,067	131,100,954	0	0	4,698	4,698	0	163,217,498
2020	1,687,504	92,574,968	781,586	128,699,653	0	0	4,704	4,704	0	160,842,753
2021	1,654,286	91,157,863	773,636	126,974,619	0	0	4,707	4,707	0	159,132,049
2022	1,691,188	92,686,388	774,149	129,334,728	0	0	4,703	4,703	0	161,484,279
2023	1,723,148	93,049,024	776,681	129,688,868	0	0	4,702	4,702	0	161,809,884
2024	1,684,684	93,361,651	785,202	129,718,992	0	0	4,702	4,702	0	161,851,504
2025	1,692,058	91,052,846	767,697	127,146,097	0	0	4,707	4,707	0	159,309,742
2026	1,726,887	94,678,072	784,932	131,758,483	0	0	4,697	4,697	0	163,866,361
2027	1,681,286	88,270,005	747,139	124,032,335	0	0	4,714	4,714	0	156,236,738
2028	1,654,446	96,276,328	817,746	132,368,125	0	0	4,697	4,697	0	164,473,110
2029	1,722,161	91,632,675	763,638	128,262,089	0	0	4,704	4,704	0	160,406,953
2030	1,724,648	93,227,844	776,736	129,961,553	0	0	4,702	4,702	0	162,077,663
2031	1,638,454	88,573,386	748,281	124,495,170	0	0	4,713	4,713	0	156,708,695
2032	1,720,004	97,218,504	817,185	133,821,998	0	0	4,694	4,694	0	165,910,122
2033	1,676,579	91,125,625	766,728	127,310,571	0	0	4,705	4,705	0	159,459,186
2034	1,670,437	91,959,325	777,010	128,027,635	0	0	4,704	4,704	0	160,181,627
2035	1,771,220	95,765,615	785,254	133,409,642	0	0	4,694	4,694	0	165,501,959
<b>TOTAL</b>	<b>72,993,534</b>	<b>4,605,354,017</b>	<b>37,422,697</b>	<b>6,174,733,116</b>	<b>0</b>	<b>0</b>	<b>209,196</b>	<b>209,196</b>	<b>8,723,728</b>	<b>7,684,957,169</b>

**TABLE B-16B. Minimum OMP&R Component of Transportation Charge for Each Contractor for Off-Aqueduct Power Facilities**

(in dollars)

Sheet 1 of 4

Calendar Year	NORTH BAY AREA			SOUTH BAY AREA				CENTRAL COASTAL AREA		
	Napa County FC&WCD	Solano County WA	Total	Alameda County FC&WCD, Zone 7	Alameda County Water District	Santa Clara Valley Water District	Total	San Luis Obispo County FC&WCD	Santa Barbara County FC&WCD	Total
	[1]	[2]	[3]	[4]	[5]	[6]	[7]	[8]	[9]	[10]
1971	0	0	0	0	0	0	0	0	0	0
1972	0	0	0	0	0	0	0	0	0	0
1973	0	0	0	0	0	0	0	0	0	0
1974	0	0	0	0	0	0	0	0	0	0
1975	0	0	0	0	0	0	0	0	0	0
1976	0	0	0	0	0	0	0	0	0	0
1977	0	0	0	0	0	0	0	0	0	0
1978	0	0	0	0	0	0	0	0	0	0
1979	0	0	0	0	0	0	0	0	0	0
1980	0	0	0	0	0	0	0	0	0	0
1981	0	0	0	0	0	0	0	0	0	0
1982	0	0	0	0	0	0	0	0	0	0
1983	10,070	0	10,070	47,473	31,446	863,937	942,856	0	0	0
1984	29,957	0	29,957	157,280	77,388	2,040,188	2,274,856	0	0	0
1985	54,709	0	54,709	458,427	582,679	2,696,450	3,737,556	0	0	0
1986	45,887	0	45,887	312,938	365,147	2,595,765	3,273,850	0	0	0
1987	90,385	0	90,385	622,029	674,111	2,306,079	3,602,219	0	0	0
1988	115,970	114,196	230,166	616,865	804,606	2,116,236	3,537,707	0	0	0
1989	64,584	138,240	202,824	407,353	396,069	1,389,347	2,192,769	0	0	0
1990	77,126	138,805	215,931	535,269	514,372	1,490,250	2,539,891	0	0	0
1991	35,178	245,181	280,359	355,578	477,883	1,065,488	1,898,949	0	165,930	165,930
1992	74,573	230,716	305,289	405,244	529,119	1,183,466	2,117,829	0	0	0
1993	89,214	247,977	337,191	841,383	256,930	1,552,562	2,650,875	0	0	0
1994	111,942	229,598	341,540	501,812	559,683	1,395,238	2,456,733	0	0	0
1995	96,842	235,605	332,447	833,227	492,578	796,524	2,122,329	0	0	0
1996	63,698	205,414	269,112	367,297	304,845	1,189,291	1,861,433	711	105	816
1997	48,518	193,255	241,773	455,751	294,951	1,220,497	1,971,199	44,788	298,986	343,774
1998	82,317	251,217	333,534	380,321	380,282	1,103,662	1,864,265	198,376	1,028,220	1,226,596
1999	58,017	195,562	253,579	559,900	446,655	1,039,572	2,046,127	147,204	791,946	939,150
2000	28,759	128,393	157,152	374,808	237,138	748,820	1,360,766	82,628	474,268	556,896
2001	81,666	157,196	238,862	396,340	233,205	673,431	1,302,976	134,574	595,294	729,868
2002	40,384	128,219	168,603	384,774	230,122	521,729	1,136,625	91,976	586,079	678,055
2003	37,618	92,735	130,353	301,657	180,804	643,729	1,126,190	78,771	477,048	555,819
2004	50,258	128,102	178,360	447,529	209,965	546,009	1,203,503	526,009	661,706	754,485
2005	53,455	149,328	202,783	452,896	265,252	772,420	1,490,568	106,901	587,036	693,937
2006	59,239	127,708	186,947	476,295	277,304	798,098	1,551,697	109,498	605,502	715,000
2007	90,265	176,367	266,632	442,518	245,347	735,669	1,423,534	102,697	754,456	857,153
2008	271,993	538,171	810,164	1,090,143	740,803	1,461,512	3,292,458	381,781	1,124,726	1,506,507
2009	214,977	293,443	508,420	887,087	496,629	1,370,646	2,754,362	992,784	1,806,310	2,799,094
2010	220,086	359,678	579,764	899,248	535,019	1,388,949	2,823,216	1,006,041	1,830,431	2,836,472
2011	218,390	352,000	570,390	901,283	522,918	1,357,533	2,781,734	983,286	1,789,029	2,772,315
2012	221,651	352,424	574,075	910,293	522,869	1,357,405	2,790,567	983,193	1,788,861	2,772,054
2013	154,854	198,639	353,493	606,048	383,299	855,352	1,844,699	553,445	1,006,959	1,560,404
2014	34,706	44,577	79,283	151,982	85,906	191,705	429,593	124,040	225,683	349,723
2015	21,114	26,444	47,558	90,043	50,896	113,577	254,516	73,489	133,708	207,197
2016	18,523	22,651	41,174	77,128	43,596	97,286	218,010	62,948	114,530	177,478
2017	18,212	21,757	39,969	74,083	41,875	93,446	209,404	60,463	110,009	170,472
2018	7,752	9,052	16,804	30,190	17,421	38,876	86,487	25,155	45,767	70,922
2019	7,887	9,006	16,893	30,666	17,334	38,681	86,681	25,028	45,537	70,565
2020	8,480	9,683	18,163	32,972	18,637	41,590	93,199	26,910	48,961	75,871
2021	13,396	14,928	28,324	50,829	28,730	64,114	143,673	41,484	75,478	116,962
2022	12,714	14,168	26,882	48,241	27,268	60,850	136,359	39,372	71,635	111,007
2023	9,054	10,089	19,143	34,354	19,418	43,333	97,105	28,038	51,014	79,052
2024	6,606	7,361	13,967	25,065	14,168	31,617	70,850	20,457	37,221	57,678
2025	669	745	1,414	2,538	1,435	3,201	7,174	2,071	3,769	5,840
2026	960	1,070	2,030	3,643	2,059	4,595	10,297	2,973	5,409	8,382
2027	1,623	1,809	3,432	6,160	3,482	7,770	17,412	5,027	9,147	14,174
2028	1,006	1,121	2,127	3,818	2,158	4,816	10,792	3,116	5,669	8,785
2029	992	1,106	2,098	3,765	2,128	4,749	10,642	3,073	5,591	8,664
2030	0	0	0	0	0	0	0	0	0	0
2031	0	0	0	0	0	0	0	0	0	0
2032	0	0	0	0	0	0	0	0	0	0
2033	0	0	0	0	0	0	0	0	0	0
2034	0	0	0	0	0	0	0	0	0	0
2035	0	0	0	0	0	0	0	0	0	0
<b>TOTAL</b>	<b>3,056,276</b>	<b>5,803,736</b>	<b>8,860,012</b>	<b>17,094,543</b>	<b>12,645,929</b>	<b>40,116,060</b>	<b>69,856,532</b>	<b>6,635,077</b>	<b>17,362,020</b>	<b>23,997,097</b>



**TABLE B-16B. Minimum OMP&R Component of Transportation Charge for Each Contractor for Off-Aqueduct Power Facilities**

(in dollars)

Sheet 2 of 4

Calendar Year	SAN JOAQUIN VALLEY AREA							
	Dudley Ridge Water District	Empire West Side Irrigation District	Kern County Water Agency		County of Kings	Oak Flat Water District	Tulare Lake Basin Water Storage District	Total
			Municipal and Industrial	Agricultural				
	[11]	[12]	[13]	[14]	[15]	[16]	[17]	[18]
1971	0	0	0	0	0	0	0	0
1972	0	0	0	0	0	0	0	0
1973	0	0	0	0	0	0	0	0
1974	0	0	0	0	0	0	0	0
1975	0	0	0	0	0	0	0	0
1976	0	0	0	0	0	0	0	0
1977	0	0	0	0	0	0	0	0
1978	0	0	0	0	0	0	0	0
1979	0	0	0	0	0	0	0	0
1980	0	0	0	0	0	0	0	0
1981	0	0	0	0	0	0	0	0
1982	0	0	0	0	0	0	0	0
1983	159,191	0	34,366	2,964,185	13,174	9,673	3,733	3,184,322
1984	389,518	0	816,103	9,095,509	26,774	33,576	49,601	10,411,081
1985	527,952	59,322	1,053,957	11,978,046	38,810	42,297	1,253,257	14,953,641
1986	552,172	12,858	885,988	11,788,714	40,659	38,275	872,008	14,190,674
1987	450,941	24,936	1,192,388	10,448,063	39,134	37,538	911,938	13,104,938
1988	425,261	31,146	1,130,988	9,910,050	35,851	26,779	850,225	12,410,300
1989	331,852	17,226	607,908	7,400,983	22,959	24,306	754,007	9,159,241
1990	219,381	7,731	428,482	5,216,562	12,089	12,046	344,943	6,241,234
1991	13,048	3,111	570,942	146,276	0	1,354	30,685	765,416
1992	244,630	13,395	706,155	5,788,599	18,587	15,716	480,903	7,267,985
1993	471,706	25,543	1,202,455	11,405,212	37,276	36,803	1,159,908	14,338,903
1994	262,029	15,161	901,463	6,786,208	19,257	19,061	567,521	8,570,700
1995	626,214	16,830	1,486,494	12,489,555	41,275	36,377	1,051,178	15,747,923
1996	407,919	13,446	1,226,968	9,219,091	28,668	24,001	1,691,135	12,611,228
1997	423,144	(6)	794,476	7,471,645	(31)	22,025	137,304	8,848,557
1998	471,993	4,597	837,228	8,366,817	127	25,458	175,371	9,881,591
1999	360,554	19,182	874,948	7,723,883	24,159	20,065	1,749,925	10,772,716
2000	193,895	5,762	392,659	4,215,772	11,530	9,847	667,127	5,496,592
2001	200,485	6,563	113,854	2,948,087	7,528	11,821	287,409	3,575,747
2002	153,869	4,557	309,688	2,803,477	9,257	10,806	301,042	3,592,696
2003	125,188	3,901	301,142	2,626,386	10,030	7,904	287,531	3,362,082
2004	167,903	12,186	431,994	2,937,167	30,970	10,800	278,035	3,869,055
2005	315,142	14,807	358,007	5,609,958	76,490	11,047	540,681	6,926,132
2006	287,977	13,112	401,503	5,488,668	38,075	11,559	432,313	6,673,207
2007	188,520	8,704	240,767	3,501,090	24,131	10,161	363,729	4,337,102
2008	231,753	8,837	480,739	4,475,165	37,095	13,053	326,355	5,572,997
2009	349,714	18,296	779,769	6,283,020	57,935	23,709	584,993	8,097,436
2010	354,384	18,540	790,181	6,453,811	58,709	24,025	549,544	8,249,194
2011	346,368	18,121	772,309	6,222,910	57,381	23,482	537,114	7,977,685
2012	346,335	18,119	772,236	6,222,325	57,375	23,480	537,063	7,976,933
2013	194,954	10,199	670,416	3,524,260	32,297	13,217	302,316	4,747,659
2014	43,694	2,286	150,256	800,172	7,238	2,962	67,756	1,074,364
2015	25,887	1,354	89,021	474,070	4,289	1,755	40,143	636,519
2016	22,174	1,160	76,252	406,071	3,673	1,503	34,385	545,218
2017	21,298	1,114	73,242	390,043	3,528	1,444	33,028	523,697
2018	8,861	464	30,471	162,270	1,468	601	13,740	217,875
2019	8,816	461	30,318	161,453	1,461	598	13,671	216,778
2020	9,479	496	32,598	173,595	1,570	643	14,699	233,080
2021	14,613	765	50,252	267,609	2,421	991	22,660	359,311
2022	13,869	726	47,694	253,986	2,298	940	21,507	341,020
2023	9,877	517	33,964	180,873	1,636	670	15,316	242,853
2024	7,206	377	24,781	131,967	1,194	489	11,175	177,189
2025	730	38	2,509	13,363	121	49	1,132	17,942
2026	1,047	55	3,601	19,178	173	71	1,624	25,749
2027	1,771	93	6,090	32,431	293	120	2,746	43,544
2028	1,098	57	3,774	20,101	182	74	1,702	26,988
2029	1,082	57	3,722	19,822	179	73	1,678	26,613
2030	0	0	0	0	0	0	0	0
2031	0	0	0	0	0	0	0	0
2032	0	0	0	0	0	0	0	0
2033	0	0	0	0	0	0	0	0
2034	0	0	0	0	0	0	0	0
2035	0	0	0	0	0	0	0	0
<b>TOTAL</b>	<b>9,985,494</b>	<b>436,202</b>	<b>22,225,118</b>	<b>205,018,498</b>	<b>939,295</b>	<b>643,244</b>	<b>18,375,856</b>	<b>257,623,707</b>

**TABLE B-16B. Minimum OMP&R Component of Transportation Charge for Each Contractor for Off-Aqueduct Power Facilities**

(in dollars)

Sheet 3 of 4

Calendar Year	SOUTHERN CALIFORNIA AREA									
	Antelope Valley-East Kern Water Agency	Castaic Lake Water Agency	Coachella Valley Water District	Crestline-Lake Arrowhead Water Agency	Desert Water Agency	Littlerock Creek Irrigation District	Mojave Water Agency	Palmdale Water District	San Bernardino Valley Municipal Water District	San Gabriel Valley Municipal Water District
	[19]	[20]	[21]	[22]	[23]	[24]	[25]	[26]	[27]	[28]
1971	0	0	0	0	0	0	0	0	0	0
1972	0	0	0	0	0	0	0	0	0	0
1973	0	0	0	0	0	0	0	0	0	0
1974	0	0	0	0	0	0	0	0	0	0
1975	0	0	0	0	0	0	0	0	0	0
1976	0	0	0	0	0	0	0	0	0	0
1977	0	0	0	0	0	0	0	0	0	0
1978	0	0	0	0	0	0	0	0	0	0
1979	0	0	0	0	0	0	0	0	0	0
1980	0	0	0	0	0	0	0	0	0	0
1981	0	0	0	0	0	0	0	0	0	0
1982	0	0	0	0	0	0	0	0	0	0
1983	1,083,881	411,247	565,798	35,432	894,572	1,250	0	0	233,134	28,548
1984	2,499,848	1,122,640	1,427,428	102,114	2,263,172	77	0	0	502,967	693,074
1985	3,749,257	1,572,025	2,032,672	170,137	3,230,451	0	0	157,601	884,188	601,583
1986	3,159,857	1,694,487	2,097,408	173,460	3,340,188	15,873	0	301,486	739,563	1,088,901
1987	3,167,759	1,694,698	1,991,841	190,149	3,230,424	95,994	1,786	258,719	1,951,799	1,091,691
1988	2,688,113	1,776,471	1,940,156	187,156	3,194,137	30,395	846	126,639	2,000,664	839,774
1989	2,357,669	1,348,806	1,326,863	132,076	2,218,516	50,948	13,206	493,424	1,257,332	792,087
1990	2,528,625	1,335,341	1,463,452	115,746	2,413,745	110,678	0	545,342	1,192,997	1,054,762
1991	1,048,414	531,160	1,022,405	125,256	1,686,304	65,111	473,291	488,207	540,119	796,531
1992	2,760,199	1,548,472	1,124,775	55,985	1,855,065	22,891	1,130,876	367,996	362,232	853,047
1993	3,559,487	1,332,392	2,256,338	29,498	3,721,492	60,615	1,101,799	640,919	425,969	1,406,255
1994	3,963,982	1,450,328	1,345,145	74,879	2,218,411	88,549	1,371,116	678,876	871,358	1,452,741
1995	4,324,009	1,901,361	2,498,462	44,237	4,120,837	43,892	881,146	636,541	75,278	1,397,623
1996	3,572,856	1,507,542	4,652,945	77,384	7,674,388	31,691	760,763	723,670	458,246	1,201,941
1997	3,411,379	1,468,949	4,294,703	42,135	4,319,206	24,319	891,191	648,652	625,340	1,175,556
1998	3,977,988	1,599,394	7,554,910	16,624	6,174,031	30,365	508,248	657,806	166,952	827,650
1999	3,696,973	1,694,851	3,195,685	71,662	3,678,076	18,305	501,486	710,674	815,001	1,375,575
2000	2,372,130	994,396	1,420,806	40,083	1,954,947	0	374,972	257,146	617,664	508,258
2001	2,680,895	1,418,179	460,256	53,460	759,169	0	213,385	445,872	1,339,699	119,363
2002	1,674,587	1,389,921	569,606	74,418	939,655	0	140,550	531,620	2,422,881	844,839
2003	1,445,146	1,353,956	411,258	44,506	678,236	0	405,376	277,984	780,631	624,561
2004	1,812,210	1,676,067	554,535	71,930	759,819	0	465,681	368,704	2,071,504	449,688
2005	2,047,638	1,443,555	1,721,141	32,667	1,987,091	0	542,366	400,828	1,568,493	566,063
2006	2,845,985	1,617,750	5,071,235	26,843	2,093,821	0	1,417,777	442,278	1,533,665	681,916
2007	2,972,602	1,853,225	3,205,888	77,402	1,323,631	0	2,010,674	706,155	2,622,909	176,169
2008	4,613,306	4,148,107	4,675,471	320,248	1,768,367	39,153	1,584,181	637,037	4,198,136	814,084
2009	3,820,948	2,209,873	7,741,097	213,503	3,196,159	124,302	2,409,006	1,151,148	6,558,518	1,840,988
2010	3,871,971	2,344,529	8,961,868	224,128	3,238,839	125,962	2,441,176	1,166,520	6,646,098	1,865,571
2011	3,899,798	2,342,883	8,759,162	227,922	3,165,581	123,113	2,385,959	1,140,135	6,495,772	1,823,375
2012	4,000,053	2,445,422	8,758,338	235,497	3,165,283	123,102	2,385,735	1,140,028	6,495,161	1,823,203
2013	2,130,054	1,649,492	4,930,115	132,563	1,781,755	69,295	1,440,340	641,728	3,656,161	1,026,291
2014	954,791	653,655	1,104,955	46,323	399,333	15,531	603,865	143,826	819,432	230,016
2015	565,676	387,265	654,642	27,444	236,589	9,201	357,766	85,211	485,481	136,275
2016	484,536	331,716	560,742	23,508	202,653	7,881	306,449	72,989	415,845	116,728
2017	465,411	318,623	538,609	22,580	194,654	7,570	294,353	70,108	399,431	112,121
2018	193,625	132,557	224,078	9,394	80,982	3,149	122,460	29,167	166,175	46,646
2019	192,651	131,890	222,950	9,347	80,575	3,134	121,843	29,020	165,339	46,411
2020	207,139	141,808	239,717	10,050	86,634	3,369	131,007	31,203	177,773	49,901
2021	319,320	218,608	369,541	15,492	133,553	5,194	201,957	48,101	274,051	76,927
2022	303,065	207,480	350,729	14,704	126,754	4,930	191,676	45,653	260,100	73,010
2023	215,823	147,754	249,767	10,471	90,266	3,511	136,499	32,511	185,227	51,993
2024	157,468	107,803	182,233	7,640	65,860	2,561	99,592	23,720	135,144	37,935
2025	15,945	10,916	18,453	774	6,669	259	10,084	2,402	13,684	3,841
2026	22,884	15,667	26,483	1,110	9,571	372	14,473	3,447	19,640	5,513
2027	38,697	26,492	44,783	1,877	16,185	629	24,474	5,829	33,211	9,322
2028	23,985	16,420	27,757	1,164	10,031	390	15,169	3,613	20,584	5,778
2029	23,652	16,192	27,372	1,147	9,892	385	14,959	3,563	20,299	5,698
2030	0	0	0	0	0	0	0	0	0	0
2031	0	0	0	0	0	0	0	0	0	0
2032	0	0	0	0	0	0	0	0	0	0
2033	0	0	0	0	0	0	0	0	0	0
2034	0	0	0	0	0	0	0	0	0	0
2035	0	0	0	0	0	0	0	0	0	0
<b>TOTAL</b>	<b>95,922,287</b>	<b>53,742,365</b>	<b>102,874,573</b>	<b>3,622,125</b>	<b>84,795,569</b>	<b>1,363,946</b>	<b>28,499,558</b>	<b>17,374,098</b>	<b>63,701,847</b>	<b>30,849,823</b>

**TABLE B-16B. Minimum OMP&R Component of Transportation Charge for Each Contractor for Off-Aqueduct Power Facilities**

(in dollars)

Sheet 4 of 4

Calendar Year	SOUTHERN CALIFORNIA AREA (continued)				FEATHER RIVER AREA				TOTAL STATE WATER PROJECT (a)
	San Geronio Pass Water Agency	The Metropolitan Water District of Southern California	Ventura County Watershed Protection District	Total	City of Yuba City	County of Butte	Plumas County FC&WCD	Total	
	[29]	[30]	[31]	[32]	[33]	[34]	[35]	[36]	[37]
1971	0	0	0	0	0	0	0	0	0
1972	0	0	0	0	0	0	0	0	0
1973	0	0	0	0	0	0	0	0	0
1974	0	0	0	0	0	0	0	0	0
1975	0	0	0	0	0	0	0	0	0
1976	0	0	0	0	0	0	0	0	0
1977	0	0	0	0	0	0	0	0	0
1978	0	0	0	0	0	0	0	0	0
1979	0	0	0	0	0	0	0	0	0
1980	0	0	0	0	0	0	0	0	0
1981	0	0	0	0	0	0	0	0	0
1982	0	0	0	0	0	0	0	0	0
1983	0	12,791,358	0	16,045,220	0	0	0	0	20,182,468
1984	0	39,229,567	0	47,840,887	0	0	0	0	60,556,781
1985	0	77,446,523	0	89,844,437	0	0	0	0	108,590,343
1986	0	77,581,287	0	90,192,510	0	0	0	0	107,702,921
1987	0	68,939,195	0	82,614,055	0	0	0	0	99,411,597
1988	0	79,936,309	0	92,720,660	0	0	0	0	108,898,833
1989	0	68,311,546	0	78,302,473	0	0	0	0	89,857,307
1990	0	83,964,409	277,885	95,002,982	0	0	0	0	104,000,038
1991	0	54,214,229	132,209	61,123,236	0	0	0	0	64,233,890
1992	0	72,401,054	0	82,482,592	0	0	0	0	92,173,695
1993	0	55,312,615	0	69,847,379	0	0	0	0	87,174,348
1994	0	72,838,621	0	86,354,006	0	0	0	0	97,722,979
1995	0	40,862,813	0	56,786,199	0	0	0	0	74,988,898
1996	0	36,536,259	401	57,198,086	0	0	0	0	71,940,675
1997	0	37,121,379	108,559	54,131,368	0	0	0	0	65,536,671
1998	0	30,341,609	149,170	52,004,747	0	0	0	0	65,310,733
1999	0	42,257,580	106,226	58,122,094	0	0	0	0	72,133,666
2000	0	43,977,877	123,318	52,641,597	0	0	0	0	60,213,003
2001	0	49,405,276	84,868	56,980,422	0	0	0	0	62,827,875
2002	0	45,579,833	154,113	54,322,023	0	0	0	0	59,898,002
2003	3,303	41,917,356	129,134	48,071,447	0	0	0	0	53,245,891
2004	44,621	58,640,223	170,747	67,085,729	0	0	0	0	73,091,132
2005	41,448	56,220,579	61,131	66,633,000	0	0	0	0	75,946,420
2006	265,078	60,701,335	70,268	76,767,951	0	0	0	0	85,894,802
2007	259,699	60,978,392	119,126	76,305,872	0	0	0	0	83,190,293
2008	945,840	97,340,396	337,268	121,421,594	0	0	0	0	132,603,720
2009	1,636,320	95,870,096	1,159,582	127,931,540	0	0	0	0	142,090,852
2010	1,658,170	95,945,746	1,175,067	129,665,645	0	0	0	0	144,154,291
2011	1,620,665	93,775,579	1,148,489	126,908,433	0	0	0	0	141,010,557
2012	1,620,512	93,766,757	1,148,381	127,107,472	0	0	0	0	141,221,101
2013	912,195	50,727,332	646,430	69,743,751	0	0	0	0	78,250,006
2014	204,444	12,817,993	144,880	18,139,044	0	0	0	0	20,072,007
2015	121,125	7,594,155	85,836	10,746,666	0	0	0	0	11,892,456
2016	103,751	6,504,865	73,524	9,205,187	0	0	0	0	10,187,067
2017	99,656	6,248,111	70,622	8,841,849	0	0	0	0	9,785,391
2018	41,460	2,599,405	29,381	3,678,479	0	0	0	0	4,070,567
2019	41,251	2,586,320	29,233	3,659,964	0	0	0	0	4,050,881
2020	44,354	2,780,824	31,431	3,935,210	0	0	0	0	4,355,523
2021	68,374	4,286,849	48,454	6,066,421	0	0	0	0	6,714,691
2022	64,894	4,068,622	45,987	5,757,604	0	0	0	0	6,372,872
2023	46,213	2,897,413	32,749	4,100,197	0	0	0	0	4,538,350
2024	33,718	2,113,991	23,894	2,991,559	0	0	0	0	3,311,243
2025	3,414	214,058	2,419	302,918	0	0	0	0	335,288
2026	4,900	307,219	3,472	434,751	0	0	0	0	481,209
2027	8,286	519,506	5,872	735,163	0	0	0	0	813,725
2028	5,136	321,991	3,639	455,657	0	0	0	0	504,349
2029	5,064	317,522	3,589	449,334	0	0	0	0	497,351
2030	0	0	0	0	0	0	0	0	0
2031	0	0	0	0	0	0	0	0	0
2032	0	0	0	0	0	0	0	0	0
2033	0	0	0	0	0	0	0	0	0
2034	0	0	0	0	0	0	0	0	0
2035	0	0	0	0	0	0	0	0	0
<b>TOTAL</b>	<b>9,903,891</b>	<b>1,951,111,974</b>	<b>7,937,354</b>	<b>2,451,699,410</b>	<b>0</b>	<b>0</b>	<b>0</b>	<b>0</b>	<b>2,812,036,758</b>

a) Costs allocated to contractors in 1989 through 2002 are reduced by credits for Off-Aqueduct Power Facility costs allocated to the pumping of non-SWP water.

**TABLE B-17. Unit Variable OMP&R Component of Transportation Charge**

(in dollars per acre-foot)

Sheet 1 of 5

Calendar Year	NORTH BAY AQUEDUCT						SOUTH BAY AQUEDUCT		CALIFORNIA AQUEDUCT	
	Reach 1 Barker Slough Pumping Plant		Reach 3A Cordelia Pumping Plant Solano County WA		Reach 3B Cordelia Pumping Plant Napa County FC&WCD (a)		Reach 1 South Bay and Del Valle Pumping Plants (b)		Reach 1 Banks Pumping Plant	
	Unit Rate	Cumulative Unit Rate	Unit Rate	Cumulative Unit Rate	Unit Rate	Cumulative Unit Rate	Unit Rate	Cumulative Unit Rate	Unit Rate	Cumulative Unit Rate
[1]	[2]	[3]	[4]	[5]	[6]	[7]	[8]	[9]	[10]	
1961	0	0	0	0	0	0	0	0	0	0
1962	0	0	0	0	0	0	4.1511341	4.1511341	0	0
1963	0	0	0	0	0	0	4.5639383	4.5639383	0	0
1964	0	0	0	0	0	0	3.5452154	3.5452154	0	0
1965	0	0	0	0	0	0	4.1911773	4.1911773	0	0
1966	0	0	0	0	0	0	3.5074573	3.5074573	0	0
1967	0	0	0	0	0	0	3.9306767	4.1752198	0.2445431	0.2445431
1968	0	0	0	0	5.7570016	5.7570016	3.3315620	4.8750942	1.5435322	1.5435322
1969	0	0	0	0	3.1823595	3.1823595	3.6949019	4.8016170	1.1067151	1.1067151
1970	0	0	0	0	3.7584301	3.7584301	4.4256141	5.3721490	0.9465349	0.9465349
1971	0	0	0	0	4.2082507	4.2082507	3.8714396	4.7522833	0.8808437	0.8808437
1972	0	0	0	0	3.9577735	3.9577735	4.3250690	5.2281686	0.9030996	0.9030996
1973	0	0	0	0	3.8103903	3.8103903	5.2455409	6.1841800	0.9386391	0.9386391
1974	0	0	0	0	3.5878850	3.5878850	6.3321503	7.2293909	0.8972406	0.8972406
1975	0	0	0	0	2.1606725	2.1606725	3.7365711	4.8327731	1.0962020	1.0962020
1976	0	0	0	0	2.9283909	2.9283909	4.5191527	5.7132795	1.1941268	1.1941268
1977	0	0	0	0	2.7516411	2.7516411	4.7630172	6.5309008	1.7679736	1.7679736
1978	0	0	0	0	3.5949619	3.5949619	5.2086183	6.8245097	1.6158914	1.6158914
1979	0	0	0	0	2.4747752	2.4747752	4.9524184	7.1045026	2.1520842	2.1520842
1980	0	0	0	0	2.9737588	2.9737588	4.5186576	5.8960239	1.3773663	1.3773663
1981	0	0	0	0	2.6488168	2.6488168	4.3834851	6.4662961	2.0828110	2.0828110
1982	0	0	0	0	10.0222589	10.0222589	5.6383622	7.4121096	1.7737474	1.7737474
1983	0	0	0	0	1.0240490	1.0240490	0.8686507	1.7250802	0.8564295	0.8564295
1984	0	0	0	0	1.6524119	1.6524119	2.7719370	3.9566693	1.1847323	1.1847323
1985	0	0	0	0	2.5219114	2.5219114	3.6942124	5.3128683	1.6186559	1.6186559
1986	0	0	0	0	4.4046604	4.4046604	7.2799131	10.6056639	3.3257508	3.3257508
1987	0	0	0	0	3.5386715	3.5386715	6.4837861	9.2421280	2.7583419	2.7583419
1988	1.1792022	1.1792022	0	1.1792022	4.4545623	5.6337645	6.1749958	8.7900561	2.6150603	2.6150603
1989	1.2712038	1.2712038	2.5418648	3.8130686	4.2795803	5.5507841	8.1600349	11.6976286	3.5375937	3.5375937
1990	2.0024548	2.0024548	4.2324041	6.2348589	5.8752161	7.8776709	11.7200790	15.8670513	4.1469723	4.1469723
1991	1.2488027	1.2488027	2.6241245	3.8729272	3.8050725	5.0538752	7.5402614	11.2642022	3.7240022	3.7240022
1992	0.7095451	0.7095451	1.4174620	2.1270071	2.3506623	3.0602074	4.0600957	6.4118184	2.3517227	2.3517227
1993	-0.3463994	-0.3463994	-0.6048649	-0.9512643	-1.0204313	-1.3668307	-1.4929839	-1.2402745	0.2527094	0.2527094
1994	1.4607776	1.4607776	2.6575471	4.1183247	4.2850412	5.7458188	7.9485622	11.2592004	3.3106382	3.3106382
1995	0.7544766	0.7544766	1.2974895	2.0519661	2.2753763	3.0298529	3.2312761	5.2800374	2.0487613	2.0487613
1996	1.6427835	1.6427835	2.7704025	4.4131860	4.7993051	6.4420886	8.0186492	11.3633990	3.3447498	3.3447498
1997	1.7801484	1.7801484	3.0246843	4.8048327	5.0575904	6.8377388	9.6521246	12.6148371	2.9627125	2.9627125
1998	-0.3031174	-0.3031174	-0.5212041	-0.8243215	-0.8454623	-1.1529028	-1.7656471	-1.6140875	0.1515596	0.1515596
1999	0.7893362	0.7893362	1.2927037	2.0820399	1.9928526	2.7821888	5.1162295	6.9791811	1.8629516	1.8629516
2000	1.3973507	1.3973507	1.9784901	3.3758408	3.0443727	4.4417234	6.3576472	8.6695487	2.3119015	2.3119015
2001	8.2119915	8.2119915	12.6833359	20.8953274	22.9223114	31.1343029	42.6778833	55.3804905	12.7026072	12.7026072
2002	4.2246726	4.2246726	5.3443379	9.5690106	9.0113455	13.2360181	18.2782152	24.4115705	6.1333552	6.1333552
2003	4.3658918	4.3658918	7.1156312	11.4815229	12.8272299	17.1931217	22.7673291	26.0823961	6.7351080	6.7351080
2004	4.8168805	4.8168805	6.1857512	11.0026317	12.9168921	17.7337725	19.4729290	26.6477905	7.1748615	7.1748615
2005	6.1386959	6.1386959	7.3872190	13.5259149	19.0798018	25.2184977	25.3904898	33.3135671	7.9230773	7.9230773
2006	4.8205633	4.8205633	15.3886000	20.2091633	17.9467657	22.7673291	22.7522588	29.3317588	7.1849000	7.1849000
2007	7.3683975	7.3683975	10.4641790	17.8325765	22.1626801	29.5310776	30.3885074	40.4243486	10.0358412	10.0358412
2008	8.4216344	8.4216344	16.6559907	25.0776251	26.6326715	35.0543059	39.9882504	51.4458509	11.4576005	11.4576005
2009	10.3773598	10.3773598	20.4622006	30.8395603	31.5702203	41.9475801	48.7989570	62.8293417	14.0303847	14.0303847
2010	7.8169631	7.8169631	15.4791864	23.2961494	25.1060798	32.9230429	37.3279752	47.9815150	10.6535398	10.6535398
2011	7.7163769	7.7163769	12.2096276	19.9260045	22.7335343	30.4499112	43.9686151	55.8978525	11.9292374	11.9292374
2012	7.9543703	7.9543703	12.6111715	20.5655418	23.6741401	31.6285104	45.0452125	56.7032025	11.6579900	11.6579900
2013	8.0985355	8.0985355	13.8730112	21.9715467	21.3844564	29.4829919	39.9047586	54.6896263	14.6948677	14.6948677
2014	8.6850234	8.6850234	14.8771109	23.5621343	23.5905387	32.2755621	41.1952723	53.2852776	12.0900053	12.0900053
2015	8.8188288	8.8188288	15.0797297	23.8985585	24.1973674	33.0161962	41.7944668	55.3057347	13.5112679	13.5112679
2016	8.9171122	8.9171122	15.2345770	24.1516892	24.6663769	33.5834891	42.2079761	57.7608498	15.5528737	15.5528737
2017	8.8163244	8.8163244	15.0134841	23.8298085	24.4648818	33.2812062	41.6176079	55.3377777	13.7201698	13.7201698
2018	9.0632657	9.0632657	15.4498531	24.5131188	25.4799134	34.5431791	43.1004463	56.8458759	13.7454296	13.7454296
2019	9.2834288	9.2834288	15.8335194	25.1169482	26.4171550	35.7005838	43.8069815	59.6196241	15.8126426	15.8126426
2020	8.9028267	8.9028267	14.9618096	23.8646363	25.5887399	34.4915666	41.4795388	55.5374435	14.0579047	14.0579047
2021	8.8253462	8.8253462	14.9370740	23.7624202	25.0478471	33.8731933	41.4136353	55.8963812	13.7827459	13.7827459
2022	8.5641139	8.5641139	14.4505288	23.0146427	24.1561144	32.7202283	40.1146246	52.8885006	12.7739660	12.7739660
2023	8.6105529	8.6105529	14.5369859	23.1475388	24.3145711	32.9251240	40.3454490	54.1369661	13.7915171	13.7915171
2024	8.9133824	8.9133824	15.1010282	24.0144106	25.3482804	34.2616428	41.8513404	56.9725365	15.1211961	15.1211961
2025	8.8748829	8.8748829	15.0292597	23.9041426	25.2168102	34.0916931	41.6598438	54.3470391	12.6872153	12.6872153
2026	8.9332960	8.9332960	15.1380729	24.0713689	25.4162590	34.3495550	41.9503192	57.7013326	15.7510134	15.7510134
2027	8.8039228	8.8039228	14.8971504	23.7010732	24.9746469	33.7785697	41.3069791	55.4365465	14.1295674	14.1295674
2028	8.8625573	8.8625573	15.0063161	23.8688734	25.1747847	34.0373420	41.5986177	56.8818999	14.3885722	14.3885722
2029	8.7542430	8.7542430	14.8046416	23.5588846	24.8051326	33.5593756	41.0600678	54.7973040	13.7372362	13.7372362
2030	8.8219752	8.8219752	14.9307873	23.7527625	25.0362728	33.8582480	41.3967487	55.7078253	14.3110766	14.3110766
2031	8.7061641	8.7061641	14.7150999	23.4212640	24.6409576	33.3471217	40.8209115	53.7898516	12.9689401	12.9689401
2032	8.8725531	8.8725531	15.0249706	23.8975237	25.2089907	34.0815438	41.6483470	55.7603280	14.1119810	14.1119810
2033	9.3009944	9.3009944	15.8228848	25.1238792	26.8712711	35.9722855	43.7786271	58.7605169	14.9818898	14.9818898
2034	8.9723292	8.9723292	15.2107814	24.1831106	25.5495005	34.5218297	42.1444670	56.1746114	14.0301444	14.0301444
2035	8.7963479	8.7963479	14.8829906	23.6793385	24.9487427	33.7450906	41.2693428	56.1023608	14.8330180	14.8330180

a) For the period 1968 through 1987, rates are for an interim facility.

b) The relatively minor costs of Del Valle Pumping Plant have been combined with those of South Bay Pumping Plant to simplify the allocation procedure.

**TABLE B-17. Unit Variable OMP&R Component of Transportation Charge**

(in dollars per acre-foot)

Sheet 2 of 5

Calendar Year	CALIFORNIA AQUEDUCT (continued)									
	Reach 4 Dos Amigos Pumping Plant		Reach 14A Buena Vista Pumping Plant		Reach 15A Teerink Pumping Plant		Reach 16A Chrisman Pumping Plant		Reach 17E Edmonston Pumping Plant	
	Unit Rate	Cumulative Unit Rate	Unit Rate	Cumulative Unit Rate	Unit Rate	Cumulative Unit Rate	Unit Rate	Cumulative Unit Rate	Unit Rate	Cumulative Unit Rate
[11]	[12]	[13]	[14]	[15]	[16]	[17]	[18]	[19]	[20]	
1961	0	0	0	0	0	0	0	0	0	0
1962	0	0	0	0	0	0	0	0	0	0
1963	0	0	0	0	0	0	0	0	0	0
1964	0	0	0	0	0	0	0	0	0	0
1965	0	0	0	0	0	0	0	0	0	0
1966	0	0	0	0	0	0	0	0	0	0
1967	0	0	0	0	0	0	0	0	0	0
1968	1.0745886	2.6181208	0	0	0	0	0	0	0	0
1969	0.7051830	1.8118981	0	0	0	0	0	0	0	0
1970	0.7838143	1.7303492	0.3333333	2.0636825	0	0	0	0	0	0
1971	0.4151197	1.2959634	1.3603318	2.6562952	4.9729730	7.6292682	0	0	0	0
1972	0.5689843	1.4720839	1.0818018	2.5538857	1.1418280	3.6957137	2.2892599	5.9849736	7.3206022	13.3055758
1973	0.6025584	1.5411975	0.9854386	2.5266361	1.2143719	3.7410080	2.1051633	5.8461713	7.4512435	13.2974148
1974	0.5766848	1.4739254	0.9233319	2.3972573	1.0924098	3.4896671	1.9449022	5.4345693	6.9004732	12.3350425
1975	0.4638166	1.5600186	0.8201332	2.3801518	0.9574493	3.3376011	1.9610412	5.2986423	6.9962702	12.2949125
1976	0.5196472	1.7137740	0.9637643	2.6775383	1.0211874	3.6987257	2.2275746	5.9263003	7.9384515	13.8647518
1977	0.6172856	2.3852592	1.0980643	3.4833235	1.3715867	4.8549102	2.9301764	7.7850866	9.9900004	17.7840870
1978	0.4578324	2.0737238	0.9617095	3.0354333	1.0432284	4.0786627	1.9992416	6.0779043	7.1214594	13.1993637
1979	0.6624709	2.8145551	1.1111583	3.9257134	1.2652451	5.1909585	2.7288840	7.9198425	9.6837428	17.6038583
1980	0.8090774	2.1864437	1.3528383	3.5392820	1.5041463	5.0434283	3.2274062	8.2708345	11.0353314	19.3061659
1981	1.0965610	3.1793720	1.2422925	4.4216645	1.3219771	5.7436416	2.9988606	8.7425022	10.0207633	18.7632655
1982	0.8365509	2.6102983	1.2049224	3.8152207	1.3715109	5.1867316	2.9378063	8.1245379	10.2603631	18.3851740
1983	0.3691099	1.2255394	0.7604543	1.9859937	0.8857383	2.8717320	1.8026411	4.6743731	5.5653668	10.0697399
1984	0.6642414	1.8489737	1.0562168	2.9051905	1.2202995	4.1254900	2.5897300	6.7152200	8.3105777	15.0257977
1985	0.8780315	2.4966874	1.4221464	3.9188338	1.6516280	5.5704616	3.5176053	9.0880671	11.8858945	20.9739616
1986	1.4047267	4.7304775	2.3730496	7.1035271	2.7567993	9.8603264	6.0029982	15.8633246	20.6708919	36.5342165
1987	1.2966188	4.0549607	2.2362590	6.2912197	2.5459999	8.8372196	5.3658848	14.2031044	17.8358435	32.0389479
1988	1.2001961	3.8152564	2.1148911	5.9301475	2.4017135	8.3318610	5.0600095	13.3918705	16.6769503	30.0688208
1989	1.4991710	5.0367647	2.6962512	7.7330159	3.0078924	10.7409083	6.6054692	17.3463775	22.2552075	39.6015850
1990	1.9023461	6.0493184	3.3101004	9.3594188	3.7483042	13.1077230	8.7425943	21.8503173	31.1242008	52.9745181
1991	1.0592185	4.7832207	2.1212585	6.9044792	2.4222131	9.3266923	5.7602628	15.0869551	20.6708919	35.7064889
1992	0.9064819	3.2582046	1.4858303	4.7440349	1.7077285	6.4517634	3.6067199	10.0584833	12.1335007	22.1919840
1993	0.1664878	0.4191972	-0.1384508	0.2807464	-0.1312944	0.1494520	-0.7173389	-1.8524509	-3.5014056	-4.0692925
1994	1.4294391	4.7400773	2.5099528	7.2500301	2.7989861	10.0490162	6.1401376	16.1891538	21.5691939	37.7583477
1995	0.8047106	2.8534719	1.3496693	4.2031412	1.4945512	5.6976924	3.1864400	8.8841324	10.8322270	19.7163594
1996	1.6726383	5.0173881	2.5952092	7.6125973	2.8425227	10.4551200	6.3087407	16.7638607	22.6207778	39.4059385
1997	1.2769880	4.2397005	2.5012144	6.7409149	2.6893394	9.4302543	6.2890095	15.7192638	23.0714697	38.7907335
1998	-0.2050857	-0.0535261	-0.3945877	-0.4481138	-0.4188957	-0.8670095	-0.8544414	-1.8524509	-3.5014056	-4.0692925
1999	0.8422034	2.7051550	1.4022138	4.1073688	1.2802066	5.3875754	3.4122984	8.7998738	13.6052879	22.4051617
2000	0.9316549	3.2435564	1.6394743	4.8830307	1.8026042	6.6856349	4.2496003	10.9352352	15.5598613	26.4950965
2001	6.1193793	18.8219865	11.2725023	30.9044888	12.3601920	42.4546808	28.5680342	71.0227150	106.9263979	177.9491128
2002	2.6473913	8.7807465	4.6355438	13.4172903	5.0569039	18.4741942	11.7019905	30.1761846	43.4837175	73.6599021
2003	3.1429017	9.8780097	5.6418887	15.5198984	6.1466260	21.4665244	14.3017388	35.9682632	53.1783305	89.1465938
2004	3.2649455	10.4398070	5.7479412	16.1877482	6.2400492	22.4277973	14.5398729	36.9676702	54.0553692	91.0230394
2005	3.7410992	11.6641765	6.7111593	18.3753359	7.2747956	25.6501314	16.9141969	42.5643283	60.6903154	103.2546438
2006	3.1808000	10.3657000	5.6939000	16.0596000	6.2135000	22.2731000	14.4060000	36.6791000	53.4785000	90.1576000
2007	4.4853942	14.5212355	7.9801534	22.5013888	8.7653081	31.2666969	20.1428695	51.4095664	74.8389029	126.2484693
2008	5.1343293	16.5919298	8.9978377	25.5897675	10.9428038	36.5325714	23.6646633	60.1972347	84.7264979	146.9237326
2009	6.3143272	20.3447119	11.1249329	31.4696447	13.5330534	45.0026982	29.2761453	74.2788434	104.7399019	179.0187453
2010	4.7246157	15.3781555	8.3284551	23.7066106	10.1312995	33.8379101	21.9131662	55.7510763	78.5063559	134.2574322
2011	5.5990294	17.5282668	10.5203543	28.0486211	11.0425566	39.0911777	26.5060877	65.5972654	99.6183648	165.2156302
2012	5.9847340	17.6427240	11.4283878	29.0711118	12.0269662	41.0980780	28.9123106	70.0103896	108.6678897	176.6782783
2013	6.5206767	21.2155444	12.7513220	33.9668664	13.3035656	47.2704320	31.9503439	79.2207759	121.4434560	200.6642319
2014	6.4335988	18.5236041	12.0373234	30.5609275	12.4687507	43.0296782	29.8652863	72.8949645	113.3084213	186.2033858
2015	6.5330124	20.0442803	12.2156747	32.2599550	12.6509747	44.9109297	30.3037929	75.2147226	114.9699981	190.1847207
2016	6.7725341	22.3254078	12.8178136	35.1432214	13.2946323	48.4378537	31.8731709	80.3110246	122.9774594	201.2884840
2017	6.5367479	20.2569177	12.2399907	32.4969084	12.6791685	45.1760769	30.3754128	75.5514897	115.2474876	190.7989773
2018	6.9099146	20.6553442	13.1290638	33.7844080	13.8227213	47.4071293	32.6687240	80.0758533	124.0153046	204.0911579
2019	7.1220422	22.9346848	13.5012473	36.4359321	14.0025107	50.4384428	33.5850084	84.0234512	127.4822401	211.5056913
2020	6.7245238	20.7824285	12.7754484	33.5578769	13.2595941	46.8174710	31.7971764	78.6146474	120.7053223	199.3199697
2021	6.7221335	20.5048794	12.7726261	33.2775055	13.2572087	46.5347142	31.7922265	78.3269407	120.6871720	199.0141127
2022	6.5199786	19.2939446	12.4140467	31.7079913	12.8921575	44.6001488	30.9157072	75.5158560	117.3683264	192.8841824
2023	6.5913545	20.3828716	12.5789149	32.9617865	13.0668668	46.0284733	31.3399499	77.3684232	118.9891217	196.5754449
2024	6.8130859	21.9342820	12.9554448	34.8897268	13.4471056	48.3368324	32.2512342	80.5880666	122.4331417	203.0212083
2025	6.7903669	19.4775822	12.9307784	32.4083606	13.4244846	45.8328452	32.1984252	78.0312704	122.2392109	200.2704813
2026	6.8265632	22.5775766	12.9724791	35.5500557	13.4633299	49.0133856	32.2896916	81.3030772	122.5764235	203.8795007
2027	6.7646757	20.8942431	12.9114151	33.8056582	13.4095449	47.2152031	32.1664805	79.3818836	122.1279503	201.5096339
2028	6.7571103	21.1456825	12.8407441	33.9864266	13.3275419	47.3139685	31.9619895	79.2595808	121.3320498	200.6800778
2029	6.7021407	20.4393769	12.7742957	33.2136726	13.2653267	46.4789993	31.8167718	78.2957711	120.7940219	199.0897930
2030	6.7106132	21.0216898	12.7408427	33.7625325	13.2282371	46.9853696	31.7083311	78.6937007	120.3651214	199.0588221
2031	6.6648380	19.6337781	12.7456785	32.3794566	13.2421850	45.6216416	31.7632562	77.3848978	120.6064213	197.9913191
2032	6.7175253	20.8295063	12.7017921	33.5312984	13.1747204	46.7060188	31.5876375	78.2938563	119.8889633	198.1826196
2033	7.2361701	22.2180599	13.8743966	36.0924565	14.0106880	50.5033245	34.5857874	85.0891119	131.3365887	216.4257006
2034	6.8305829	20.8607273	12.9413988	33.8021261	13.4253510	47.2274771	32.1943043	79.4217814	122.2003663	201.6221477
2035	7.1920109	22.0250289	14.1963462	36.2213751	14.8109049	51.0322800	35.6054362	86.6377162	135.3556413	221.9933575

**TABLE B-17. Unit Variable OMP&R Component of Transportation Charge**

(in dollars per acre-foot)

Sheet 3 of 5

Calendar Year	CALIFORNIA AQUEDUCT (continued)							
	Reach 18A Alamo Powerplant		Reach 22B Pearblossom Pumping Plant		Reach 23 Mojave Siphon Powerplant		Reach 26A Devil Canyon Powerplant	
	Unit Rate	Cumulative Unit Rate	Unit Rate	Cumulative Unit Rate	Unit Rate	Cumulative Unit Rate	Unit Rate	Cumulative Unit Rate
	[21]	[22]	[23]	[24]	[25]	[26]	[27]	[28]
1961	0	0	0	0	0	0	0	0
1962	0	0	0	0	0	0	0	0
1963	0	0	0	0	0	0	0	0
1964	0	0	0	0	0	0	0	0
1965	0	0	0	0	0	0	0	0
1966	0	0	0	0	0	0	0	0
1967	0	0	0	0	0	0	0	0
1968	0	0	0	0	0	0	0	0
1969	0	0	0	0	0	0	0	0
1970	0	0	0	0	0	0	0	0
1971	0	0	0	0	0	0	0	0
1972	0	0	14.2519509	27.5575267	0	0	-2.3717647	25.1857620
1973	0	0	4.4326545	17.7300693	0	0	-8.4298618	9.3002075
1974	0	0	3.4431782	15.7782207	0	0	-5.1043660	10.6738547
1975	0	0	3.1739313	15.4688438	0	0	-5.6510611	9.8177827
1976	0	0	3.9391330	17.8038848	0	0	-6.4449941	11.3588907
1977	0	0	3.4988957	21.2829827	0	0	-11.6274558	9.6555289
1978	0	0	4.1619043	17.3612680	0	0	-8.1314274	9.2298406
1979	0	0	5.2283922	22.8319775	0	0	-9.5825772	13.2494003
1980	0	0	4.4253989	23.7315648	0	0	-11.5446606	12.1869042
1981	0	0	4.0325337	22.7957992	0	0	-6.7528607	16.0429385
1982	0	0	3.7143664	22.0995404	0	0	-6.9141441	15.1853963
1983	0	0	1.7592652	11.9990051	0	0	-23.7923414	-11.7933363
1984	0	0	2.5203002	17.5460979	0	0	-29.2940447	-11.7479468
1985	0	0	3.5406919	24.5146535	0	0	-30.7672356	-6.2525821
1986	-2.3583180	34.1759895	6.0306655	40.2065640	0	0	-29.2499580	10.9566060
1987	-2.5482255	29.4907224	5.0997322	34.5904546	0	0	-29.7006533	4.8898013
1988	-1.3847067	28.6841141	4.7880132	33.4721273	0	0	-29.0334518	4.4386755
1989	-1.1019487	38.4996363	6.4559997	44.9556360	0	0	-28.3706997	16.5849363
1990	-1.0673268	51.9071913	9.0317647	60.9389560	0	0	-28.8797266	32.0592294
1991	-1.5206590	34.1859899	6.1338271	40.3198170	0	0	-30.3294563	9.9903607
1992	-2.6080003	19.5839837	3.6796265	23.2636102	0	0	-29.7938993	-6.5302891
1993	-0.1885524	-4.2578449	-0.9592579	-5.2171028	0	0	-30.6629489	-35.8800517
1994	-0.1279266	37.6304211	6.5139903	44.1444114	0	0	-30.4781656	13.6662458
1995	-3.4425314	16.2738280	3.4305039	19.7043319	0	0	-30.3517624	-10.6474305
1996	-5.9839345	33.4220040	6.6794995	40.1015035	-2.3423415	37.7591620	-29.5900574	8.1691046
1997	-4.7847800	34.0059735	6.8397922	40.8457657	-3.8632009	36.9825648	-30.6066647	6.3759001
1998	-5.0614104	-10.4573480	-1.2355351	-11.6928831	-3.7700558	-15.4629389	-30.6550762	-46.1180151
1999	-4.7679511	17.6372106	3.5508098	21.1880204	-4.9754645	16.2125559	-29.6766184	-13.4640625
2000	-5.3795304	21.1155661	4.6180019	25.7335679	-5.2137446	20.5198234	-30.4798154	-9.9599920
2001	-4.6442419	173.3048710	29.9688592	203.2737301	-5.7699535	197.5037766	-30.8825050	166.6212716
2002	-5.4660253	68.1938768	13.0727227	81.2665995	-6.4072093	74.8593902	-30.1161904	44.7431998
2003	-3.3577630	85.7888308	15.6946862	101.4835169	-7.2230635	94.2604534	-30.5285166	63.7319369
2004	-5.5585791	85.4644603	15.8923087	101.3567690	-7.4295016	93.9272674	-30.2125160	63.7147514
2005	-5.4922951	97.7623487	17.4740873	115.2364360	-6.5987131	108.6377229	-30.2097976	78.4279253
2006	-14.2409000	75.9167000	15.9960000	91.9127000	-5.5334000	86.3793000	-29.9165000	56.4628000
2007	-6.0171412	120.2313281	22.5520096	142.7833377	-6.2569768	136.5263609	-29.8762900	106.6500710
2008	-5.1713527	139.7523799	26.2369682	165.9893481	-7.0591482	158.9301999	-27.9300385	131.0001614
2009	-5.1736769	173.8450684	32.3899032	206.2349716	-7.0786363	199.1563353	-27.9364727	171.2198626
2010	-6.5000000	127.7574322	24.2811117	152.0385439	-7.2742057	144.7643382	-27.9297213	116.8346169
2011	-4.1202186	161.0954116	25.3774738	186.4728854	-10.0329794	176.4399060	-26.7871380	149.6527680
2012	-4.3978754	174.2804029	28.0959094	202.3763123	-11.4755978	190.9007145	-27.5239628	163.3767517
2013	-4.5012629	196.1629690	32.4311393	228.5941083	-12.0288998	216.5672085	-28.8180827	187.7491258
2014	-4.1736932	182.0296926	33.9773484	216.0070410	-12.0508246	203.9562164	-29.3225466	174.6336698
2015	-4.1783435	186.0063772	34.6668658	220.6732430	-11.9846640	208.6885790	-29.6668079	179.0217711
2016	-4.3592141	196.9292699	37.0722269	234.0014968	-13.1205176	220.8809792	-30.3280556	190.5529236
2017	-4.1602291	186.6387482	34.8103794	221.4491276	-11.9594824	209.4896452	-30.0065173	179.4831279
2018	-4.4672664	199.6238915	38.5706232	238.1945147	-14.5127621	223.6817526	-30.8429328	192.8388198
2019	-4.2430590	207.2626323	37.7607100	245.0233423	-12.4286352	232.5947071	-30.4641500	202.1305571
2020	-4.3279197	194.9920500	36.6556103	231.6476603	-13.2083117	218.4393486	-31.3657799	187.0735687
2021	-4.3399652	194.6741475	36.6854360	231.3595835	-13.2712322	218.0883513	-31.0225089	187.0658424
2022	-4.3673823	188.5168001	35.3787070	223.8955071	-13.3099889	210.5855182	-30.6351951	179.9503231
2023	-4.4274069	191.9301380	36.1521675	228.0823055	-13.7485220	214.3337835	-31.2396049	183.0941786
2024	-4.2833232	198.7378851	36.5368952	235.2745803	-12.8385469	222.4360334	-30.9862045	191.4498289
2025	-4.3654185	195.9050628	36.8504236	232.7554864	-13.4218690	219.3336174	-30.6214977	188.7121197
2026	-4.3341777	199.5453230	37.1834133	236.7287366	-13.1658550	223.5628813	-31.3978725	192.1650088
2027	-4.3642660	197.1453679	36.7359571	233.8813250	-13.3313973	220.5499277	-30.9529649	189.5969268
2028	-4.3166298	196.2913780	36.7125220	233.0039000	-13.1325632	219.8713368	-31.1636322	188.7077046
2029	-4.3391941	194.7505989	36.3291150	231.0797139	-13.2688871	217.8108268	-30.9311341	186.8796927
2030	-4.3027615	194.7560606	36.3791595	231.1352201	-13.0302859	218.1049342	-31.0067954	187.0981388
2031	-4.4313808	193.5599383	36.6973981	230.2573364	-14.5869039	215.6704325	-30.7458081	184.9246244
2032	-4.2477977	193.9348219	35.6523608	229.5871827	-12.9528536	216.6343291	-30.4685433	186.1657558
2033	-4.4810022	211.9446984	40.1758734	252.1205718	-15.0246287	237.0959431	-31.4918741	205.6040690
2034	-4.2909125	197.3312352	36.5226066	233.8538418	-13.4121401	220.4417017	-30.3183707	190.1233310
2035	-4.5424013	217.4509562	38.2690743	255.7200305	-14.9137515	240.8062790	-32.0804016	208.7258774

**TABLE B-17. Unit Variable OMP&R Component of Transportation Charge**

(in dollars per acre-foot)

Sheet 4 of 5

Calendar Year	CALIFORNIA AQUEDUCT (continued)							
	Reach 2B (EBX) Greenspot Pumping Plant		Reach 3A (EBX) Crafton Hills Pumping Plant		Reach 4B (EBX) Cherry Valley Pumping Plant		Reach 29A Oso Pumping Plant	
	Unit Rate	Cumulative Unit Rate	Unit Rate	Cumulative Unit Rate	Unit Rate	Cumulative Unit Rate	Unit Rate	Cumulative Unit Rate
[29]	[30]	[31]	[32]	[33]	[34]	[35]	[36]	
1961	0	0	0	0	0	0	0	0
1962	0	0	0	0	0	0	0	0
1963	0	0	0	0	0	0	0	0
1964	0	0	0	0	0	0	0	0
1965	0	0	0	0	0	0	0	0
1966	0	0	0	0	0	0	0	0
1967	0	0	0	0	0	0	0	0
1968	0	0	0	0	0	0	0	0
1969	0	0	0	0	0	0	0	0
1970	0	0	0	0	0	0	0	0
1971	0	0	0	0	0	0	0	0
1972	0	0	0	0	0	0	1.4212193	14.7267951
1973	0	0	0	0	0	0	1.0210537	14.3184685
1974	0	0	0	0	0	0	0.9241725	13.2592150
1975	0	0	0	0	0	0	0.9362286	13.2311411
1976	0	0	0	0	0	0	0.8622774	14.7270292
1977	0	0	0	0	0	0	0.9076172	18.6917042
1978	0	0	0	0	0	0	0.7314697	13.9308334
1979	0	0	0	0	0	0	0.9509677	18.5545530
1980	0	0	0	0	0	0	1.4272378	20.7334037
1981	0	0	0	0	0	0	1.5690769	20.3323424
1982	0	0	0	0	0	0	1.4942990	19.8801030
1983	0	0	0	0	0	0	1.2824635	11.5222034
1984	0	0	0	0	0	0	1.7818310	16.8076287
1985	0	0	0	0	0	0	2.1691578	23.1431194
1986	0	0	0	0	0	0	3.2296473	39.7638638
1987	0	0	0	0	0	0	3.1281318	35.1670797
1988	0	0	0	0	0	0	2.9887414	33.0575622
1989	0	0	0	0	0	0	3.5266078	43.1281928
1990	0	0	0	0	0	0	3.6820302	56.6565483
1991	0	0	0	0	0	0	2.1966277	37.9032766
1992	0	0	0	0	0	0	1.9058052	24.0977892
1993	0	0	0	0	0	0	0.1578038	-3.9114887
1994	0	0	0	0	0	0	3.0574815	40.8158292
1995	0	0	0	0	0	0	1.5732257	21.2895851
1996	0	0	0	0	0	0	3.1318961	42.5378346
1997	0	0	0	0	0	0	2.7928728	41.5836063
1998	0	0	0	0	0	0	-0.3008626	-5.6968002
1999	0	0	0	0	0	0	1.8929287	24.2980904
2000	0	0	0	0	0	0	1.8205294	28.3156258
2001	0	0	0	0	0	0	13.5034055	191.4525183
2002	0	0	0	0	0	0	4.9201780	78.5800801
2003	0	0	0	0	0	0	6.1428628	95.2894565
2004	0	0	0	0	0	0	6.3357925	97.3588319
2005	0	0	0	0	0	0	7.1557832	110.4104269
2006	0	0	0	0	0	0	6.2183000	96.3759000
2007	21.2286516	127.8787226	26.7511980	154.6299206	2.8777313	157.5076520	8.9116499	135.1601192
2008	31.4917484	162.4919098	39.0496024	201.5415122	8.1319275	209.6734397	10.5667512	155.4904837
2009	39.1304784	210.3503410	48.5826673	258.9330083	10.0964229	269.0294312	13.0606293	192.0793747
2010	29.1300052	145.9646221	36.1021686	182.0667907	7.5245446	189.5913354	9.8002161	144.0576483
2011	31.8252601	181.4780281	39.7175723	221.1956004	8.1846821	229.3802825	15.6444980	180.8601282
2012	31.8252601	195.2020118	39.7175723	234.9195841	8.1846821	243.1042662	17.0081649	195.6864432
2013	31.8252601	219.5743859	39.7175723	259.2919582	8.1846821	267.4786403	17.7915738	218.4558057
2014	31.8252601	206.4589299	39.7175723	246.1765022	8.1846821	254.3611843	14.8951481	201.0985339
2015	31.8252601	210.8470312	39.7175723	250.5646035	8.1846821	258.7492856	15.0270023	205.2117230
2016	31.8252601	222.3781837	39.7175723	262.0957560	8.1846821	270.2804381	15.5946172	216.8831012
2017	31.8252601	211.3083880	39.7175723	251.0259603	8.1846821	259.2106424	15.0231192	205.8220965
2018	31.8252601	224.6640799	39.7175723	264.3816522	8.1846821	272.5663343	15.7629293	219.8540872
2019	31.8252601	233.9558172	39.7175723	273.6733895	8.1846821	281.8580716	16.9583523	228.4640436
2020	31.8252601	218.8988288	39.7175723	258.6164011	8.1846821	266.8010832	15.7330895	215.0530592
2021	31.8252601	218.8911025	39.7175723	258.6086748	8.1846821	266.7933569	15.7047590	214.7188717
2022	31.8252601	211.7755832	39.7175723	251.4931555	8.1846821	259.6778376	15.4668715	208.3510539
2023	31.8252601	214.9194387	39.7175723	254.6370110	8.1846821	262.8216931	15.5504881	211.9080330
2024	31.8252601	223.2750890	39.7175723	262.9926613	8.1846821	271.1773434	16.2775019	219.2987102
2025	31.8252601	220.5373798	39.7175723	260.2549521	8.1846821	268.4396342	16.0595448	216.3300261
2026	31.8252601	223.9902689	39.7175723	263.7078412	8.1846821	271.8925233	15.9768021	219.8563028
2027	31.8252601	221.4222229	39.7175723	261.1397952	8.1846821	269.3244773	16.1224651	217.6320990
2028	31.8252601	220.5329647	39.7175723	260.2505370	8.1846821	268.4352191	15.8662113	216.4742191
2029	31.8252601	218.7049528	39.7175723	258.4225251	8.1846821	266.6072072	15.9471226	215.0369156
2030	31.8252601	218.9233989	39.7175723	258.6409712	8.1846821	266.8256533	15.7555262	214.8143483
2031	31.8252601	216.7498845	39.7175723	256.4674568	8.1846821	264.6521389	15.8411257	213.8324448
2032	31.8252601	217.9910459	39.7175723	257.7086182	8.1846821	265.8933003	15.8997892	214.0824088
2033	31.8252601	237.4293291	39.7175723	277.1469014	8.1846821	285.3315835	17.0513237	233.4707243
2034	31.8252601	221.9485911	39.7175723	261.6661634	8.1846821	269.8508455	16.1106352	217.7327829
2035	31.8252601	240.5511375	39.7175723	280.2687098	8.1846821	288.4533919	19.7521390	241.7454965

**TABLE B-17. Unit Variable OMP&R Component of Transportation Charge**

(in dollars per acre-foot)

Sheet 5 of 5

Calendar Year	CALIFORNIA AQUEDUCT (continued)							
	Reach 29G Warne Powerplant		Reach 29J Castaic Powerplant		Reach 31A Las Perillas & Badger Hill Pumping Plants		Reach 33A Devil's Den, Bluestone, and Polonio Pass Pumping Plants	
	Unit Rate	Cumulative Unit Rate	Unit Rate	Cumulative Unit Rate	Unit Rate	Cumulative Unit Rate	Unit Rate	Cumulative Unit Rate
[37]	[38]	[39]	[40]	[41]	[42]	[43]	[44]	
1961	0	0	0	0	0	0	0	0
1962	0	0	0	0	0	0	0	0
1963	0	0	0	0	0	0	0	0
1964	0	0	0	0	0	0	0	0
1965	0	0	0	0	0	0	0	0
1966	0	0	0	0	0	0	0	0
1967	0	0	0	0	0	0	0	0
1968	0	0	0	0	1.5014866	4.1196074	0	0
1969	0	0	0	0	1.2624065	3.0743046	0	0
1970	0	0	0	0	1.6309699	3.3613191	0	0
1971	0	0	0	0	1.4985537	2.7945171	0	0
1972	0	0	-2.9350830	11.7917121	1.9517720	3.4238559	0	0
1973	0	0	-6.8099448	7.5085237	1.5374531	3.0786506	0	0
1974	0	0	-7.4013274	5.8578876	1.5168982	2.9908236	0	0
1975	0	0	-6.5604921	6.6706490	1.1130304	2.6730490	0	0
1976	0	0	-6.7213324	8.0056968	1.5685447	3.2823187	0	0
1977	0	0	-30.4985994	-11.8068952	1.7573375	4.1425967	0	0
1978	0	0	-9.0130187	4.9178147	1.9429506	4.0166744	0	0
1979	0	0	-19.0478097	-0.4932567	1.5600341	4.3745892	0	0
1980	0	0	-7.4485479	13.2848558	1.5124754	3.6989191	0	0
1981	0	0	-10.0059379	10.3264045	1.5414199	4.7207919	0	0
1982	-2.1714430	17.7086600	-9.5987314	8.1099286	1.7581649	4.3684632	0	0
1983	-8.9130752	2.6091282	-39.8193120	-37.2101838	0.1783064	1.4038458	0	0
1984	-15.0246012	1.7830275	-17.3128964	-15.5296689	0.8560669	2.7050406	0	0
1985	-14.7115359	8.4315835	-38.9450653	-30.5134818	1.2075223	3.7042097	0	0
1986	-14.1893653	25.5744985	-28.1596224	-2.5851239	2.2635962	6.9940737	0	0
1987	-14.8696165	20.2974632	-27.0536484	-6.7561852	1.9135150	5.9684757	0	0
1988	-14.7032843	18.3542779	-25.6857024	-7.3114245	1.7733304	5.5885868	0	0
1989	-14.4231503	28.7050425	-25.3986130	-3.3064295	2.4154074	7.4521721	0	0
1990	-14.1850383	42.4715100	-26.0776141	16.3938959	3.7962241	9.8455425	0	0
1991	-14.7813217	23.1219549	-25.1420394	-2.0200845	2.4124332	7.1956539	0	0
1992	-14.6199453	9.4778439	-25.1951380	-15.7172941	1.2766497	4.5348543	0	0
1993	-10.3386629	-14.2501516	-21.1218951	-35.3720467	-1.1726278	-0.7534306	0	0
1994	-14.7696788	26.0461504	-26.7435205	-0.6973701	2.3664953	7.1065726	0	0
1995	-12.2705911	9.0189940	-25.6908056	-16.6718116	2.5750190	5.4284909	0	0
1996	-14.8515762	27.6862584	-29.5639188	-1.8776604	2.5837041	7.6010922	0	0
1997	-14.9272063	26.6564000	-27.1541858	-0.4977858	2.7029648	6.9426653	24.4572499	31.3999152
1998	-8.6041243	-14.3009245	-22.2303491	-36.5312736	-0.4719744	-0.5255005	-3.9178748	-4.4433753
1999	-15.4517685	8.8463219	-27.8324731	-18.9861512	1.3273109	4.0324659	9.8021998	13.8346657
2000	-14.1657262	14.1498996	-26.9670098	-12.8171102	1.8861983	5.1297547	14.2513950	19.3811497
2001	-14.7349298	174.7175896	-29.2914155	145.4261731	12.3563556	31.1783420	92.6567653	123.8351073
2002	-13.2004532	65.3796269	-23.7780801	41.6015468	5.4664522	14.2471987	41.2910819	55.5382806
2003	-13.9757183	81.3137382	-23.6270529	57.6866853	6.3405497	16.2185594	47.1787976	63.3973570
2004	-14.1574752	83.2013568	-23.6679973	59.5333594	6.3551621	16.7949690	50.7286903	67.5216593
2005	-14.2938791	96.1165479	-23.7301832	72.3863646	8.0399019	19.7040785	60.5159993	80.2200777
2006	-14.2409000	82.1350000	-23.8088000	58.3262000	7.3739000	17.7396000	55.6538000	73.3934000
2007	-13.9431723	121.2169469	-25.3788169	95.8381300	9.9685265	24.4897619	67.8464811	92.3362431
2008	-14.1661152	141.3243686	-25.1899747	116.1343939	11.7050503	28.2969801	84.6367817	112.9337417
2009	-14.1553900	177.9239847	-25.3142244	152.6097603	14.1435919	34.4883037	102.7409227	137.2292265
2010	-14.1489215	129.9087269	-25.2020343	104.7066926	10.9024922	26.2806477	79.5433742	105.8240219
2011	-20.0168418	160.8432864	-34.1351054	126.7081810	13.3465965	30.8748633	88.2622281	119.1370914
2012	-20.9015535	174.7848897	-35.8848672	138.9000225	13.7701732	31.4128972	91.2995417	122.7124389
2013	-20.1769370	198.2788687	-34.5529922	163.7258765	15.4224755	36.6380199	100.2148434	136.8528633
2014	-15.8964059	185.2021280	-27.0386653	158.1634627	16.4844394	35.0080435	107.6279668	142.6360103
2015	-15.8125844	189.3991386	-26.8814298	162.5177088	16.7174154	36.7616957	109.2541656	146.0158613
2016	-16.2575317	200.6255695	-27.6614318	172.9641377	16.8781849	39.2035927	110.3765453	149.5801380
2017	-15.8721389	189.9499576	-27.0221000	162.9278576	16.6486534	36.9055711	108.7741803	145.6795714
2018	-16.1210825	203.7330047	-27.5179064	176.2150983	17.1016569	37.7570011	111.9364197	149.6934208
2019	-16.9945129	211.4695307	-29.1315713	182.3379594	17.4999183	40.4346031	114.7163852	155.1509883
2020	-16.6643335	198.3887257	-28.4505137	169.9382120	16.5949707	37.3773992	108.3994880	145.7768872
2021	-16.6567005	198.0621712	-28.4565385	169.6056327	16.5693583	37.0742377	108.2205862	145.2948239
2022	-16.9268847	191.4241692	-28.9260230	162.4981462	16.0642824	35.3582270	104.6949560	140.0531830
2023	-16.9225409	194.9854921	-28.9187849	166.0667072	16.1540259	36.5388975	105.3214801	141.8583776
2024	-17.0909893	202.2077209	-29.2107143	172.9970066	16.7395350	38.6738170	109.4085264	148.0823434
2025	-16.9375708	199.3924553	-28.9451980	170.4472573	16.6650766	36.1426588	108.8888229	145.0314817
2026	-16.7358458	203.1204570	-28.5962524	174.5242046	16.7780172	39.3555938	109.6772893	149.0328831
2027	-17.1503370	200.4817620	-29.3098576	171.1719044	16.5278916	37.4221347	107.9311720	145.3533067
2028	-16.7570505	199.7171686	-28.6308403	171.0863283	16.8412681	37.7869506	108.7226937	146.5096446
2029	-17.0592524	197.9776632	-29.1558839	168.8217793	16.4318767	36.8712536	107.2610116	144.1322652
2030	-16.7196752	198.0946731	-28.5683383	169.5263348	16.5627841	37.5844739	108.1748564	145.7593303
2031	-16.9450442	196.8874006	-28.9781630	167.9092376	16.3388945	35.9726726	106.6119268	142.5845994
2032	-16.7401196	197.3422892	-28.7060934	168.6361958	16.6606091	37.4901154	108.8576480	146.3477634
2033	-16.9689290	216.5080953	-29.1662830	187.3418120	17.4888827	39.7084266	114.6394099	154.3463525
2034	-16.7621290	200.9706539	-28.7524285	172.2182254	16.8535047	37.7142320	110.2041642	147.9183962
2035	-20.9639972	220.7814993	-36.0534430	184.7280563	16.5132481	38.5382770	107.8289485	146.3672255



**Tables B-18 through B-31 Follow**

**TABLE B-18. Variable OMP&R Component of Transportation Charge for Each Contractor**

(in dollars)

Sheet 1 of 4

Calendar Year	NORTH BAY AREA			SOUTH BAY AREA				CENTRAL COASTAL AREA		
	Napa County FC&WCD	Solano County WA	Total	Alameda County FC&WCD, Zone 7	Alameda County Water District	Santa Clara Valley Water District	Total	San Luis Obispo County FC&WCD	Santa Barbara County FC&WCD	Total
	[1]	[2]	[3]	[4]	[5]	[6]	[7]	[8]	[9]	[10]
1961	0	0	0	0	0	0	0	0	0	0
1962	0	0	0	2,051	34,919	0	36,970	0	0	0
1963	0	0	0	7,900	49,811	0	57,711	0	0	0
1964	0	0	0	5,931	68,203	0	74,134	0	0	0
1965	0	0	0	10,918	68,765	62,926	142,609	0	0	0
1966	0	0	0	19,330	52,135	121,141	192,606	0	0	0
1967	0	0	0	19,958	53,785	163,255	236,998	0	0	0
1968	6,989	0	6,989	29,899	120,985	341,768	492,652	0	0	0
1969	8,551	0	8,551	31,859	3,904	298,968	334,722	0	0	0
1970	13,598	0	13,598	49,687	0	431,443	481,130	0	0	0
1971	10,609	0	10,609	23,842	28,328	416,329	468,499	0	0	0
1972	14,434	0	14,434	54,838	144,669	524,208	723,715	0	0	0
1973	14,449	0	14,449	18,398	15,590	547,807	581,795	0	0	0
1974	17,473	0	17,473	9,499	29	636,186	645,714	0	0	0
1975	14,779	0	14,779	22,318	4,765	425,284	452,367	0	0	0
1976	20,856	0	20,856	97,874	121,693	502,769	722,336	0	0	0
1977	22,635	0	22,635	82,578	123,044	497,792	703,414	0	0	0
1978	21,692	0	21,692	74,911	39,986	652,860	767,757	0	0	0
1979	16,237	0	16,237	137,101	77,145	652,629	866,875	0	0	0
1980	19,945	0	19,945	98,743	64,891	517,531	681,165	0	0	0
1981	23,842	0	23,842	126,437	141,456	567,968	835,861	0	0	0
1982	12,157	0	12,157	97,117	46,742	651,246	795,105	0	0	0
1983	2,342	0	2,342	8,171	5,412	148,743	162,326	0	0	0
1984	4,822	0	4,822	26,707	13,141	349,314	389,162	0	0	0
1985	10,188	0	10,188	79,863	102,790	466,291	648,944	0	0	0
1986	15,501	0	15,501	112,370	131,118	932,090	1,175,578	0	0	0
1987	27,223	0	27,223	216,211	234,290	812,631	1,263,132	0	0	0
1988	31,265	11,533	42,798	229,578	297,129	779,537	1,306,244	0	0	0
1989	37,874	66,850	104,724	306,533	304,275	1,051,562	1,662,370	0	0	0
1990	54,736	105,421	160,157	524,114	502,545	1,456,008	2,482,667	0	0	0
1991	8,159	18,824	26,983	105,736	142,105	316,839	564,680	0	(2,636)	(2,636)
1992	12,515	23,808	36,323	93,772	122,436	273,849	490,057	0	0	0
1993	(7,223)	(17,293)	(24,516)	(36,162)	(12,912)	(78,024)	(127,098)	0	0	0
1994	39,106	77,257	116,363	231,800	257,533	642,006	1,131,339	0	0	0
1995	15,701	36,724	52,425	160,663	93,610	151,287	405,560	0	0	0
1996	31,526	96,570	128,096	214,883	186,694	735,431	1,137,008	502	0	502
1997	29,683	116,555	146,238	351,185	219,799	912,861	1,483,845	34,932	233,584	268,516
1998	(6,178)	(18,511)	(24,689)	(6,218)	(16,448)	(65,206)	(87,874)	(15,961)	(82,727)	(98,688)
1999	14,757	52,720	67,477	243,434	193,968	450,667	888,069	51,783	278,589	330,372
2000	22,022	94,310	116,332	378,285	239,318	755,432	1,373,030	76,788	440,747	517,535
2001	290,950	534,351	825,301	1,688,783	997,070	2,851,440	5,537,293	530,386	2,346,180	2,876,566
2002	90,998	268,287	359,285	1,074,401	642,200	1,461,863	3,178,464	241,869	1,541,397	1,783,266
2003	131,458	266,997	398,455	1,079,980	649,713	2,307,741	4,037,434	282,325	1,709,803	1,992,128
2004	144,247	343,537	487,784	1,301,725	613,444	1,584,553	3,499,722	281,237	2,005,796	2,287,033
2005	193,400	376,423	569,823	1,450,936	829,776	2,438,169	4,718,881	341,016	1,872,657	2,213,673
2006	175,202	322,087	497,289	1,317,036	752,486	2,200,051	4,269,573	308,913	1,708,232	2,017,145
2007	336,232	636,071	972,303	1,595,023	886,730	2,661,209	5,142,962	348,662	2,513,393	2,862,055
2008	542,971	389,723	932,694	2,424,293	1,423,249	3,481,822	7,329,364	2,823,344	3,452,272	6,275,616
2009	817,638	978,982	1,796,620	3,345,683	1,858,868	5,229,794	10,434,345	3,430,731	6,242,009	9,672,740
2010	648,204	894,394	1,542,598	2,552,891	1,516,609	3,992,303	8,061,803	2,645,601	4,813,511	7,459,112
2011	608,444	780,134	1,388,578	3,043,769	1,762,050	4,647,111	9,452,930	2,978,427	5,419,070	8,397,497
2012	641,467	806,068	1,447,535	3,123,718	1,785,731	4,712,683	9,622,132	3,067,811	5,581,698	8,649,509
2013	741,497	856,794	1,598,291	3,640,278	2,296,964	5,134,222	11,071,464	3,421,322	6,224,889	9,646,211
2014	811,730	920,001	1,731,731	3,946,006	2,237,982	4,980,911	11,164,899	3,565,900	6,487,942	10,053,842
2015	852,643	934,466	1,787,109	4,103,863	2,322,841	5,177,959	11,604,663	3,650,397	6,641,677	10,292,074
2016	888,283	944,431	1,832,714	4,300,031	2,425,956	5,421,731	12,147,718	3,739,503	6,803,802	10,543,305
2017	901,089	932,091	1,833,180	4,108,262	2,324,187	5,182,969	11,615,418	3,641,994	6,626,389	10,268,383
2018	956,846	958,738	1,915,584	4,132,205	2,387,527	5,322,682	11,842,414	3,742,336	6,808,955	10,551,291
2019	1,011,219	982,312	1,993,531	4,437,303	2,504,024	5,595,113	12,536,440	3,878,775	7,057,198	10,935,973
2020	976,974	934,463	1,911,437	4,127,625	2,332,573	5,206,194	11,666,392	3,644,422	6,630,807	10,275,229
2021	983,189	929,921	1,913,090	4,100,767	2,318,248	5,172,723	11,591,738	3,632,371	6,608,880	10,241,251
2022	949,705	900,884	1,850,589	3,925,753	2,221,321	4,952,913	11,099,987	3,501,330	6,370,459	9,871,789
2023	955,652	906,045	1,861,697	4,024,789	2,273,753	5,076,156	11,374,698	3,546,459	6,452,570	9,999,029
2024	994,444	939,706	1,934,150	4,240,468	2,392,847	5,346,871	11,980,186	3,702,059	6,735,673	10,437,732
2025	989,511	935,425	1,924,936	4,030,503	2,282,576	5,086,011	11,399,090	3,625,787	6,596,902	10,222,689
2026	996,996	941,918	1,938,914	4,298,363	2,423,456	5,418,896	12,140,715	3,725,822	6,778,910	10,504,732
2027	980,423	927,539	1,907,962	4,121,627	2,328,335	5,198,232	11,648,194	3,633,833	6,611,541	10,245,374
2028	987,934	934,055	1,921,989	4,163,011	2,351,462	5,250,304	11,764,777	3,662,741	6,664,138	10,326,879
2029	974,061	922,018	1,896,079	4,071,948	2,301,487	5,136,151	11,509,586	3,603,307	6,556,000	10,159,307
2030	982,736	929,546	1,912,282	4,142,054	2,339,729	5,223,921	11,705,704	3,643,983	6,630,009	10,273,992
2031	967,900	916,674	1,884,574	3,992,760	2,259,174	5,037,424	11,289,358	3,564,615	6,485,603	10,050,218
2032	989,217	935,168	1,924,385	4,143,826	2,341,934	5,226,725	11,712,485	3,658,694	6,656,774	10,315,468
2033	1,044,095	982,789	2,026,884	4,369,469	2,467,942	5,510,627	12,348,038	3,858,659	7,020,598	10,879,257
2034	1,001,996	946,258	1,948,254	4,173,369	2,359,334	5,264,322	11,797,025	3,697,960	6,728,216	10,426,176
2035	979,451	926,695	1,906,146	4,179,956	2,356,299	5,269,463	11,805,718	3,659,181	6,657,660	10,316,841
TOTAL	27,121,047	28,699,759	55,820,806	123,034,588	71,845,520	175,864,685	370,744,793	101,429,816	192,909,167	294,338,983

Note: B-18 includes Extra Peaking Charges for additional power shown in Table 9.

**TABLE B-18. Variable OMP&R Component of Transportation Charge for Each Contractor**

(in dollars)

Sheet 2 of 4

Calendar Year	SAN JOAQUIN VALLEY AREA								
	Dudley Ridge Water District	Empire West Side Irrigation District	Future Contractor San Joaquin Valley	Kern County Water Agency		County of Kings	Oak Flat Water District	Tulare Lake Basin Water Storage District	Total
				Municipal and Industrial	Agricultural				
	[11]	[12]	[13]	[14]	[15]	[16]	[17]	[18]	[19]
1961	0	0	0	0	0	0	0	0	0
1962	0	0	0	0	0	0	0	0	0
1963	0	0	0	0	0	0	0	0	0
1964	0	0	0	0	0	0	0	0	0
1965	0	0	0	0	0	0	0	0	0
1966	0	0	0	0	0	0	0	0	0
1967	0	0	0	0	0	0	0	0	0
1968	68,977	5,176	0	0	440,922	2,355	4,760	65,680	587,870
1969	56,774	101	0	0	321,387	181	3,338	17,956	399,737
1970	69,818	6,811	0	0	470,867	0	5,595	16,550	569,641
1971	53,097	7,747	0	0	769,054	4,785	6,353	158,419	999,455
1972	62,365	8,515	0	0	1,151,788	2,057	7,375	379,686	1,611,786
1973	33,931	4,615	0	0	770,121	2,307	3,017	77,630	891,621
1974	49,114	4,413	0	46,752	677,660	2,206	3,114	106,332	889,591
1975	63,140	4,671	0	34,580	848,249	2,491	3,920	134,295	1,091,346
1976	70,851	5,132	0	94,853	966,820	2,737	4,910	100,597	1,245,701
1977	26,565	1,758	0	84,875	498,624	3,644	2,602	43,067	661,135
1978	108,944	938	0	190,675	1,616,975	4,319	6,294	24,901	1,953,046
1979	107,956	4,871	0	194,048	2,371,175	5,602	13,172	434,472	3,131,297
1980	88,746	1,935	0	121,603	1,731,588	4,762	7,766	163,301	2,119,701
1981	129,687	18,533	0	263,077	2,398,339	7,275	8,904	263,922	3,089,737
1982	108,561	937	0	145,246	2,375,404	4,541	6,763	48,137	2,689,589
1983	61,443	0	0	13,954	929,183	5,662	3,232	1,218	1,014,692
1984	82,423	0	0	216,437	1,996,259	5,946	7,475	10,496	2,319,036
1985	114,571	12,938	0	242,645	2,567,184	8,422	8,815	271,970	3,226,545
1986	236,756	5,513	0	377,798	4,876,960	17,433	16,927	376,088	5,907,475
1987	187,090	10,273	0	504,168	4,230,949	16,140	15,529	375,604	5,339,753
1988	188,170	14,894	0	524,965	4,250,194	15,528	11,928	374,528	5,380,207
1989	285,261	15,450	0	661,238	6,158,648	20,063	21,693	649,804	7,831,957
1990	218,786	7,710	0	845,877	4,778,185	12,056	12,072	344,008	6,218,694
1991	4,393	1,047	0	185,013	47,869	0	521	10,331	249,174
1992	76,840	4,426	0	227,332	1,699,824	6,059	5,222	151,055	2,170,758
1993	20,064	4,843	0	78,585	340,588	2,090	1,467	123,913	571,550
1994	135,626	7,854	0	471,316	3,417,815	9,967	10,102	293,748	4,346,428
1995	181,772	4,611	0	409,656	3,437,735	11,619	10,492	288,010	4,343,895
1996	286,064	9,577	0	715,404	6,328,965	21,039	16,403	1,196,303	8,573,755
1997	308,515	0	0	650,416	5,627,735	0	15,559	94,838	6,697,063
1998	19,652	(28)	0	63,221	63,450	(1)	1,318	(1,107)	146,505
1999	161,490	8,592	0	470,360	3,349,552	10,821	9,074	790,700	4,800,590
2000	196,361	5,835	0	417,381	4,037,481	11,676	10,422	643,240	5,322,396
2001	782,016	25,598	0	445,105	11,597,942	29,363	45,628	1,121,076	14,046,728
2002	429,531	12,337	0	831,424	7,493,178	25,061	29,961	814,946	9,636,438
2003	455,198	14,185	0	1,094,200	9,535,804	36,469	28,732	1,045,499	12,210,087
2004	512,493	37,194	0	1,390,386	8,791,836	94,531	33,223	848,428	11,708,091
2005	954,623	44,720	0	1,081,626	16,970,523	231,021	33,230	1,633,007	20,948,750
2006	903,001	34,020	0	1,041,216	14,003,772	98,784	30,478	1,121,644	17,232,915
2007	616,652	30,262	0	1,438,396	12,038,200	83,927	35,798	1,264,552	15,507,787
2008	885,064	49,776	0	1,980,797	17,154,732	157,958	60,725	1,591,531	21,880,583
2009	1,166,627	61,034	0	2,596,745	21,019,345	193,622	79,973	1,951,506	27,068,852
2010	881,830	46,134	0	1,961,331	16,100,781	146,419	60,725	1,367,457	20,564,677
2011	1,005,123	52,585	0	2,243,330	18,356,279	167,171	67,997	1,558,649	23,451,134
2012	1,011,687	52,928	0	2,273,081	18,705,447	168,365	66,451	1,568,826	23,846,785
2013	1,216,563	63,647	0	4,195,533	22,249,148	202,115	83,761	1,886,529	29,897,296
2014	1,062,199	55,571	0	3,749,256	20,136,467	177,390	68,913	1,647,156	26,896,952
2015	1,149,399	60,133	0	3,972,397	21,510,569	191,611	77,014	1,782,378	28,743,501
2016	1,280,206	66,976	0	4,344,468	23,631,754	212,886	88,651	1,985,220	31,610,161
2017	1,161,592	60,771	0	4,003,886	21,693,944	193,568	78,205	1,801,286	28,993,252
2018	1,184,439	61,966	0	4,152,823	22,278,090	197,414	78,349	1,836,715	29,789,796
2019	1,315,144	68,804	0	4,498,159	24,365,293	218,745	90,132	2,039,398	32,595,675
2020	1,191,727	62,347	0	4,133,239	22,264,805	198,442	80,130	1,848,015	29,778,705
2021	1,175,811	61,515	0	4,095,646	22,022,132	195,852	78,562	1,823,335	29,452,853
2022	1,106,373	57,882	0	3,895,691	20,851,896	184,430	72,812	1,715,656	27,884,740
2023	1,168,815	61,149	0	4,059,901	21,837,818	194,590	78,612	1,812,486	29,213,371
2024	1,257,778	65,803	0	4,307,257	23,313,084	209,204	86,191	1,950,440	31,189,571
2025	1,116,903	58,433	0	3,974,273	21,178,364	186,322	72,317	1,731,986	28,318,598
2026	1,294,666	67,733	0	4,395,501	23,876,044	215,202	89,781	2,007,643	31,946,570
2027	1,198,139	62,683	0	4,163,425	22,386,579	199,462	80,539	1,857,958	29,948,785
2028	1,212,557	63,437	0	4,189,018	22,597,361	201,836	82,015	1,880,316	30,226,540
2029	1,172,055	61,318	0	4,087,623	21,954,331	195,200	78,302	1,817,510	29,366,339
2030	1,205,447	63,065	0	4,161,743	22,460,945	200,658	81,573	1,869,291	30,042,722
2031	1,125,860	58,901	0	3,976,757	21,244,131	187,676	73,923	1,745,875	28,413,123
2032	1,194,426	62,489	0	4,131,073	22,294,157	198,900	80,438	1,852,201	29,813,684
2033	1,274,050	66,654	0	4,442,872	23,829,998	212,073	85,397	1,975,674	31,886,718
2034	1,196,217	62,582	0	4,160,614	22,391,709	199,249	79,972	1,854,978	29,945,321
2035	1,262,981	66,075	0	4,457,122	23,654,512	209,979	84,548	1,958,510	31,693,727
<b>TOTAL</b>	<b>40,990,995</b>	<b>2,090,395</b>	<b>0</b>	<b>122,197,189</b>	<b>761,338,519</b>	<b>6,239,277</b>	<b>2,689,192</b>	<b>66,597,169</b>	<b>1,002,142,737</b>

**TABLE B-18. Variable OMP&R Component of Transportation Charge for Each Contractor**

(in dollars)

Sheet 3 of 4

Calendar Year	SOUTHERN CALIFORNIA AREA									
	Antelope Valley-East Kern Water Agency	Castaic Lake Water Agency	Coachella Valley Water District	Crestline-Lake Arrowhead Water Agency	Desert Water Agency	Littlerock Creek Irrigation District	Mojave Water Agency	Palmdale Water District	San Bernardino Valley Municipal Water District	San Gabriel Valley Municipal Water District
	[20]	[21]	[22]	[23]	[24]	[25]	[26]	[27]	[28]	[29]
1961	0	0	0	0	0	0	0	0	0	0
1962	0	0	0	0	0	0	0	0	0	0
1963	0	0	0	0	0	0	0	0	0	0
1964	0	0	0	0	0	0	0	0	0	0
1965	0	0	0	0	0	0	0	0	0	0
1966	0	0	0	0	0	0	0	0	0	0
1967	0	0	0	0	0	0	0	0	0	0
1968	0	30,401	0	0	0	0	0	0	0	0
1969	0	30,627	0	0	0	0	0	0	0	0
1970	0	39,430	0	0	0	0	0	0	0	0
1971	0	34,871	0	0	0	0	0	0	0	0
1972	780	47,571	0	12,785	0	4,496	1,515	0	32,107	0
1973	286	28,968	102,812	6,896	159,536	3,855	0	0	301,444	0
1974	15,558	28,982	100,955	9,890	157,742	4,932	221	0	177,173	5,961
1975	99,186	28,568	108,253	12,758	170,111	6,391	0	0	136,066	50,723
1976	385,090	38,365	135,276	17,835	213,594	8,164	0	0	139,354	65,476
1977	199,166	21,006	0	23,598	0	1,974	1,702	0	239,663	74,838
1978	581,729	45,550	174,116	20,875	264,178	2,731	0	0	37,043	67,462
1979	1,058,904	83,940	228,437	28,603	340,510	2,328	90,803	0	236	3,668
1980	1,390,117	51,143	256,759	29,229	401,038	3,667	94,362	0	0	16,504
1981	1,480,362	118,583	274,149	33,632	430,304	23,861	90,590	0	254,649	57,523
1982	923,973	132,575	292,674	27,190	461,216	0	230,608	0	126,461	189,895
1983	333,772	(335,712)	172,336	10,792	272,477	385	0	0	(71,602)	(8,768)
1984	485,847	(142,910)	273,597	19,572	433,785	15	0	0	(66,353)	(91,433)
1985	821,069	(335,343)	413,406	34,603	657,011	0	0	32,464	(47,544)	(32,348)
1986	1,109,047	54,812	728,808	60,274	1,160,650	5,548	0	105,375	69,170	101,843
1987	1,019,605	(40,745)	668,383	63,601	1,083,530	32,651	585	157,843	88,076	49,930
1988	1,019,793	(74,006)	688,891	66,914	1,134,141	11,991	300	50,654	92,465	38,688
1989	1,736,901	178,359	978,885	97,114	1,633,489	38,269	8,951	350,953	340,460	210,334
1990	2,442,558	422,502	1,402,619	110,934	2,313,410	90,472	0	446,408	599,573	530,099
1991	286,485	(3,054)	277,078	33,945	456,999	17,978	128,405	132,700	35,339	52,116
1992	587,340	(208,900)	240,119	11,952	396,022	4,871	241,338	78,306	(22,718)	(53,500)
1993	(190,611)	(491,161)	(809,033)	(2,389)	(1,334,429)	(3,246)	(61,112)	(29,466)	(157,452)	(519,798)
1994	1,841,902	66,338	189,616	34,480	312,714	41,201	731,185	315,446	122,829	204,783
1995	761,209	(247,735)	(251,547)	7,960	(414,889)	7,727	165,622	114,342	(7,579)	(140,714)
1996	1,883,530	72,171	508,274	18,313	838,330	16,510	289,044	385,745	49,537	133,848
1997	2,121,818	22,440	365,342	24,076	330,153	15,099	414,596	482,212	61,553	115,882
1998	(553,432)	(722,825)	(3,952,725)	(2,892)	(3,258,099)	(4,225)	(44,233)	(80,469)	(86,610)	(429,359)
1999	1,218,255	(530,571)	(679,666)	18,353	(782,262)	6,032	167,446	245,763	(173,336)	(242,474)
2000	1,764,776	(351,463)	(421,537)	24,501	(580,010)	0	286,563	191,307	(183,254)	(170,795)
2001	10,890,564	4,503,328	1,516,253	208,761	2,500,986	0	859,606	1,807,050	4,413,464	393,226
2002	3,973,403	2,000,325	749,672	163,867	1,236,702	0	335,275	1,261,314	3,200,111	1,111,913
2003	5,149,818	3,049,311	920,481	147,329	1,518,031	0	1,444,747	990,604	1,747,211	1,397,897
2004	5,109,028	3,228,755	985,382	188,423	1,350,162	0	1,316,069	1,039,446	3,577,705	799,074
2005	5,849,219	2,946,643	3,334,677	22,270	3,849,949	0	1,542,105	1,144,993	2,664,745	1,096,737
2006	6,102,493	2,589,877	6,837,659	34,725	2,823,146	0	3,109,990	948,353	2,128,056	763,604
2007	9,656,174	4,508,908	7,809,771	285,204	3,224,458	0	6,557,076	1,788,363	6,380,372	5,159,939
2008	9,880,493	3,537,148	11,104,884	502,219	4,585,006	321,430	6,916,126	2,697,221	13,457,374	1,965,002
2009	12,290,847	5,862,215	20,734,725	665,182	8,560,962	399,844	7,771,445	3,702,900	17,583,920	4,931,132
2010	9,032,451	4,215,813	16,164,069	500,885	5,841,731	293,842	5,728,631	2,721,233	12,003,990	3,364,837
2011	11,736,767	5,201,542	20,704,460	635,184	7,482,638	370,519	7,032,175	3,431,332	15,370,446	4,310,000
2012	13,025,020	5,932,600	22,603,174	710,151	8,168,838	400,845	7,631,149	3,712,173	16,778,969	4,705,250
2013	13,868,722	8,406,122	25,975,092	805,630	9,387,456	451,175	9,243,154	4,178,271	19,280,351	5,407,175
2014	25,738,998	14,318,229	24,160,568	1,182,946	8,731,683	418,668	16,331,372	3,877,232	17,935,008	5,029,450
2015	26,301,302	14,717,150	24,767,662	1,210,394	8,951,089	427,815	16,684,218	3,961,936	18,385,434	5,155,827
2016	27,845,799	15,663,623	26,362,997	1,281,110	9,527,646	452,937	17,691,529	4,194,593	19,568,927	5,487,924
2017	26,390,719	14,754,598	24,831,491	1,215,040	8,974,156	429,269	16,742,853	3,975,405	18,432,973	5,169,114
2018	28,226,818	15,944,929	26,679,251	1,297,354	9,841,941	459,135	18,007,510	4,251,989	19,803,769	5,553,758
2019	29,306,936	16,507,154	27,964,763	1,349,049	10,106,528	476,704	18,526,135	4,414,694	20,758,874	5,821,360
2020	27,571,876	15,382,753	25,881,628	1,266,948	9,353,678	448,482	17,513,623	4,153,331	19,212,568	5,387,719
2021	27,526,924	15,351,268	25,880,559	1,264,912	9,353,292	447,751	17,491,750	4,146,559	19,211,569	5,387,496
2022	26,656,276	14,706,984	24,896,127	1,221,396	8,997,516	433,589	16,927,587	4,015,408	18,481,284	5,182,569
2023	27,138,921	15,032,372	25,331,080	1,243,136	9,154,709	441,439	17,243,991	4,088,112	18,804,206	5,273,112
2024	28,101,537	15,663,376	26,487,084	1,290,129	9,572,491	457,097	17,788,690	4,233,117	19,661,344	5,513,755
2025	27,700,976	15,420,751	26,108,322	1,272,135	9,435,606	450,582	17,597,356	4,172,778	19,380,236	5,434,909
2026	28,215,709	15,803,693	26,586,029	1,296,665	9,608,250	458,954	17,898,117	4,250,315	19,734,969	5,534,352
2027	27,876,355	15,493,067	26,230,740	1,279,190	9,479,848	453,434	17,682,836	4,199,196	19,471,220	5,460,393
2028	27,755,601	15,487,622	26,107,711	1,275,254	9,435,385	451,470	17,616,356	4,181,006	19,380,109	5,434,782
2029	27,537,735	15,280,130	25,854,805	1,263,303	9,343,985	447,926	17,470,976	4,148,188	19,192,415	5,382,135
2030	27,538,507	15,347,256	25,885,028	1,265,009	9,354,907	447,939	17,475,121	4,148,304	19,214,873	5,388,426
2031	27,369,375	15,193,340	25,584,322	1,250,889	9,246,231	445,188	17,408,185	4,122,827	18,991,714	5,325,829
2032	27,422,384	15,267,289	25,756,036	1,256,479	9,308,289	446,050	17,358,678	4,130,812	19,118,891	5,361,575
2033	29,968,980	16,949,131	28,445,323	1,375,156	10,280,203	487,473	19,061,122	4,514,422	21,113,873	5,921,397
2034	27,902,637	15,588,151	26,303,563	1,278,562	9,506,167	453,862	17,681,016	4,203,155	19,524,845	5,475,552
2035	30,747,565	16,708,972	28,877,225	1,396,676	10,436,294	500,137	19,336,316	4,631,705	21,434,523	6,011,305
TOTAL	752,231,945	394,657,102	716,888,886	33,756,956	275,581,242	12,517,233	449,861,376	124,353,920	547,485,088	150,754,909

**TABLE B-18. Variable OMP&R Component of Transportation Charge for Each Contractor**

(in dollars)

Sheet 4 of 4

Calendar Year	SOUTHERN CALIFORNIA AREA (continued)				FEATHER RIVER AREA				South Bay Area Future Contractor	GRAND TOTAL
	San Gorgonio Pass Water Agency	The Metropolitan Water District of Southern California	Ventura County Watershed Protection District	Total	City of Yuba City	County of Butte	Plumas County FC&WCD	Total		
	[30]	[31]	[32]	[33]	[34]	[35]	[36]	[37]	[38]	[39]
1961	0	0	0	0	0	0	0	0	0	0
1962	0	0	0	0	0	0	0	0	0	36,970
1963	0	0	0	0	0	0	0	0	0	57,711
1964	0	0	0	0	0	0	0	0	0	74,134
1965	0	0	0	0	0	0	0	0	0	142,609
1966	0	0	0	0	0	0	0	0	0	192,606
1967	0	0	0	0	0	0	0	0	0	236,998
1968	0	0	0	30,401	0	0	0	0	0	1,117,912
1969	0	0	0	30,627	0	0	0	0	0	773,646
1970	0	0	0	39,430	0	0	0	0	0	1,103,799
1971	0	0	0	34,871	0	0	0	0	0	1,513,434
1972	0	848,011	0	947,266	0	0	0	0	0	3,297,202
1973	0	1,083,328	0	1,687,126	0	0	0	0	0	3,174,991
1974	0	1,872,297	0	2,373,712	0	0	0	0	0	3,926,489
1975	0	3,887,152	0	4,499,209	0	0	0	0	0	6,057,701
1976	0	5,485,263	0	6,488,418	0	0	0	0	0	8,477,311
1977	0	(796,686)	0	(234,739)	0	0	0	0	0	1,152,444
1978	0	3,696,428	0	4,890,112	0	0	0	0	0	7,632,606
1979	0	4,021,960	0	5,859,389	0	0	0	0	0	9,873,798
1980	0	5,362,245	0	7,605,064	0	0	0	0	0	10,425,875
1981	0	10,862,932	0	13,626,585	0	0	0	0	0	17,576,025
1982	0	7,685,168	0	10,069,760	0	0	0	0	0	13,566,611
1983	0	(8,994,497)	0	(8,620,817)	0	0	0	0	0	(7,441,457)
1984	0	(7,633,741)	0	(6,721,621)	0	0	0	0	0	(4,008,601)
1985	0	(15,739,366)	0	(14,196,048)	0	0	0	0	0	(10,310,371)
1986	0	1,135,478	0	4,531,005	0	0	0	0	0	11,629,559
1987	0	(3,007,997)	0	116,362	0	0	0	0	0	6,746,470
1988	0	(3,407,929)	0	(378,098)	0	0	0	0	0	6,351,151
1989	0	9,488,536	0	15,062,251	0	0	0	0	0	24,661,302
1990	0	30,759,725	204,582	39,322,882	0	0	0	0	0	48,184,400
1991	0	184,870	22,623	1,625,484	0	0	0	0	0	2,463,685
1992	0	(9,471,028)	0	(8,196,198)	0	0	0	0	0	(5,499,060)
1993	0	(21,473,875)	0	(25,072,572)	0	0	0	0	0	(24,652,636)
1994	0	4,059,683	0	7,920,177	0	0	0	0	0	13,514,307
1995	0	(4,895,977)	0	(4,901,581)	0	0	0	0	0	(99,701)
1996	0	1,859,275	0	6,054,577	0	0	0	0	0	15,893,938
1997	0	2,428,729	(921)	6,336,979	0	0	0	0	0	14,932,641
1998	0	(14,440,371)	(67,583)	(23,842,827)	0	0	0	0	0	(23,707,573)
1999	0	(10,520,287)	(35,124)	(11,307,871)	0	0	0	0	0	(5,221,364)
2000	0	(14,676,247)	7,418	(14,088,741)	0	0	0	0	0	(6,759,448)
2001	0	160,070,513	269,038	187,432,789	0	0	0	0	0	210,718,677
2002	0	60,681,496	282,777	74,996,855	0	0	0	0	0	89,954,308
2003	7,393	94,646,001	362,859	111,381,682	0	0	0	0	0	130,019,786
2004	53,585	104,912,701	408,346	122,968,676	0	0	0	0	0	140,951,306
2005	54,272	110,580,524	120,524	133,206,658	0	0	0	0	0	161,657,785
2006	453,155	85,999,999	107,904	111,898,961	0	0	0	0	0	135,915,883
2007	631,448	146,465,016	335,480	188,138,109	0	0	0	0	0	212,623,216
2008	2,266,303	219,682,193	2,402,037	279,317,436	0	0	0	0	0	315,735,693
2009	4,654,209	255,745,196	3,131,935	346,034,543	0	0	0	0	0	395,007,100
2010	3,279,930	172,988,534	2,173,520	238,309,466	0	0	0	0	0	275,937,656
2011	3,968,279	216,198,704	2,641,689	299,083,735	0	0	0	0	0	341,773,874
2012	4,205,704	236,132,619	2,891,038	326,897,530	0	0	0	0	0	370,463,491
2013	4,627,346	263,569,899	3,383,359	368,583,752	0	0	0	0	0	420,797,014
2014	4,400,448	280,529,726	3,248,441	405,902,769	0	0	0	0	0	455,750,193
2015	4,476,363	288,177,326	3,335,031	416,551,547	0	0	0	0	0	468,978,894
2016	4,675,852	306,965,395	3,546,416	443,264,748	0	0	0	0	0	499,398,646
2017	4,484,344	288,952,161	3,343,677	417,695,800	0	0	0	0	0	470,406,033
2018	4,715,398	311,211,536	3,610,983	449,404,371	0	0	0	0	0	503,503,456
2019	4,876,145	324,423,552	3,738,524	468,268,418	0	0	0	0	0	526,330,037
2020	4,615,659	301,196,621	3,488,383	435,473,269	0	0	0	0	0	489,105,032
2021	4,615,525	300,826,723	3,481,751	434,986,079	0	0	0	0	0	488,185,011
2022	4,492,427	288,694,996	3,341,080	418,047,239	0	0	0	0	0	468,754,344
2023	4,546,815	294,572,422	3,412,428	426,282,743	0	0	0	0	0	478,731,538
2024	4,691,368	307,593,998	3,551,954	444,605,940	0	0	0	0	0	500,147,765
2025	4,644,006	302,597,278	3,500,123	437,715,058	0	0	0	0	0	489,580,371
2026	4,703,741	309,663,905	3,580,562	447,335,261	0	0	0	0	0	503,866,192
2027	4,659,313	304,278,207	3,515,764	440,079,563	0	0	0	0	0	493,829,878
2028	4,643,929	303,574,167	3,511,914	438,855,306	0	0	0	0	0	493,095,491
2029	4,612,305	299,970,333	3,468,277	433,972,513	0	0	0	0	0	486,903,824
2030	4,616,084	300,909,426	3,480,517	435,071,397	0	0	0	0	0	489,006,097
2031	4,578,482	297,443,139	3,449,466	430,408,987	0	0	0	0	0	482,046,260
2032	4,599,954	299,348,024	3,463,148	432,837,609	0	0	0	0	0	486,603,631
2033	4,936,236	331,383,486	3,838,710	478,275,512	0	0	0	0	0	535,416,409
2034	4,668,420	305,607,131	3,534,935	441,727,996	0	0	0	0	0	495,844,772
2035	4,990,244	331,439,633	3,808,129	480,318,724	0	0	0	0	0	536,041,156
TOTAL	126,444,682	8,786,696,560	95,891,714	12,467,121,615	0	0	0	0	0	14,190,168,933

**TABLE B-19. Total Transportation Charge for Each Contractor**

(in dollars)

Sheet 1 of 4

Calendar Year	NORTH BAY AREA			SOUTH BAY AREA				CENTRAL COASTAL AREA		
	Napa County FC&WCD	Solano County WA	Total	Alameda County FC&WCD, Zone 7	Alameda County Water District	Santa Clara Valley Water District	Total	San Luis Obispo County FC&WCD	Santa Barbara County FC&WCD	Total
	[1]	[2]	[3]	[4]	[5]	[6]	[7]	[8]	[9]	[10]
1961	0	0	0	0	0	0	0	0	0	0
1962	0	0	0	11,750	43,787	21,132	76,669	0	0	0
1963	0	0	0	199,673	190,236	447,594	837,503	0	0	0
1964	0	0	0	263,210	277,398	621,174	1,161,782	6,694	21,659	28,353
1965	0	0	0	373,722	404,239	1,157,791	1,935,753	13,751	36,017	49,768
1966	18,057	0	18,057	419,362	421,628	1,412,600	2,253,589	26,516	61,329	87,845
1967	41,560	0	41,560	538,988	498,337	1,685,708	2,723,033	56,451	118,225	174,675
1968	128,588	0	128,588	663,616	603,365	1,984,791	3,251,773	115,927	229,740	345,667
1969	254,662	0	254,662	787,057	539,211	2,082,792	3,409,061	185,118	358,783	543,901
1970	277,493	0	277,493	822,790	532,434	2,202,293	3,557,517	200,110	387,595	587,705
1971	227,419	0	227,419	787,852	551,979	2,169,421	3,509,253	202,373	392,830	595,203
1972	224,922	0	224,922	829,514	678,385	2,319,944	3,827,843	209,016	406,506	615,521
1973	221,035	31,353	252,388	794,748	549,258	2,338,141	3,682,148	206,516	402,639	609,155
1974	240,442	32,924	273,366	818,539	564,459	2,505,879	3,888,878	208,503	407,005	615,508
1975	237,400	36,276	273,676	868,410	605,595	2,409,443	3,883,448	225,853	439,787	665,639
1976	271,231	40,819	312,050	959,183	734,676	2,500,026	4,193,885	228,933	447,212	676,146
1977	293,565	45,078	338,643	923,365	713,422	2,475,917	4,112,704	238,656	468,632	707,288
1978	273,807	49,159	322,966	978,713	692,451	2,785,503	4,456,667	245,286	464,166	729,452
1979	289,415	53,320	342,735	1,043,893	736,221	2,813,091	4,593,205	243,065	483,342	726,406
1980	310,779	67,724	378,503	1,161,920	866,233	3,027,715	5,055,868	269,813	536,977	806,790
1981	347,710	87,377	435,087	1,127,601	879,216	2,917,088	4,923,905	288,950	586,152	875,102
1982	438,260	106,881	545,141	1,165,503	850,343	3,261,611	5,277,458	290,002	582,655	872,657
1983	354,703	151,207	505,911	1,177,074	900,223	3,794,952	5,872,250	319,167	633,079	952,246
1984	467,232	224,170	691,403	1,469,222	1,097,338	5,737,303	8,303,862	351,573	695,455	1,047,028
1985	735,929	364,186	1,100,115	1,919,674	1,789,224	6,551,041	10,259,940	394,545	776,889	1,171,434
1986	1,084,468	692,256	1,776,724	1,746,891	1,528,587	6,862,724	10,138,202	385,497	762,577	1,148,074
1987	1,773,371	1,558,749	3,332,120	2,236,764	2,011,731	6,674,848	10,923,343	385,240	812,199	1,197,439
1988	2,231,006	2,333,097	4,564,103	2,238,408	2,210,377	6,368,341	10,817,125	420,102	978,488	1,398,590
1989	2,396,678	3,325,671	5,722,349	2,154,723	1,871,882	5,916,199	9,942,804	414,171	1,162,567	1,576,738
1990	2,745,521	3,432,532	6,178,053	2,574,030	2,261,764	6,667,922	11,503,717	487,553	1,234,234	1,721,787
1991	2,748,016	3,681,509	6,429,525	1,753,654	1,621,035	4,527,400	7,902,088	491,359	1,476,188	1,967,547
1992	2,553,906	3,528,155	6,082,061	2,074,825	2,003,168	5,385,315	9,463,309	550,978	1,490,922	2,041,900
1993	2,592,266	3,503,436	6,095,702	2,880,064	2,011,060	6,511,316	11,402,440	610,046	1,675,150	2,285,196
1994	2,717,705	3,536,653	6,254,358	2,906,812	2,642,296	7,313,960	12,863,068	767,812	2,472,977	3,240,789
1995	2,648,648	3,509,127	6,157,775	3,035,171	2,288,863	5,893,109	11,217,143	995,188	4,975,940	5,971,129
1996	2,698,584	3,890,907	6,589,491	2,584,311	2,137,277	6,674,929	11,396,517	1,837,045	13,762,994	15,600,038
1997	2,641,264	3,630,366	6,271,631	2,657,566	2,007,165	6,550,904	11,215,635	2,294,408	21,854,824	24,149,233
1998	2,538,581	3,478,567	6,017,148	2,266,520	2,066,539	6,302,733	10,635,792	2,977,590	26,690,973	29,668,563
1999	2,683,801	3,835,375	6,519,175	2,861,823	2,439,469	8,346,681	13,647,973	3,025,667	27,439,962	30,465,629
2000	2,838,241	4,322,046	7,160,287	3,932,063	2,320,845	7,072,838	13,325,747	2,970,558	28,193,799	31,164,357
2001	3,357,082	4,935,790	8,292,872	7,434,049	2,824,993	8,902,196	19,161,238	3,526,733	30,218,691	33,745,424
2002	3,567,025	5,077,067	8,644,092	10,902,110	2,806,518	9,994,620	23,703,247	3,238,831	29,896,528	33,135,360
2003	3,676,554	5,417,532	9,094,086	7,547,696	2,532,924	8,793,203	18,873,823	3,316,569	30,137,971	33,454,540
2004	4,155,703	5,628,998	9,784,701	5,731,800	2,826,347	8,232,077	16,790,224	3,332,647	30,626,791	33,959,438
2005	3,512,957	5,131,337	8,644,295	5,730,054	2,970,547	8,976,683	17,677,284	3,455,248	30,876,214	34,331,461
2006	3,389,850	4,627,820	8,017,671	5,688,306	2,951,111	9,072,906	17,712,323	3,344,792	30,789,039	34,133,831
2007	3,834,149	5,754,677	9,588,826	6,221,482	3,416,844	10,209,138	20,247,465	3,578,271	32,697,082	36,275,354
2008	4,430,973	4,887,128	9,318,101	8,263,466	4,485,168	11,992,520	24,741,154	6,345,218	33,481,757	39,826,975
2009	5,121,959	5,985,614	11,107,573	9,560,874	4,976,347	14,427,458	28,964,680	7,660,504	37,491,819	45,152,323
2010	5,075,103	5,991,351	11,066,454	8,812,404	4,720,357	13,399,711	26,932,471	6,834,055	35,937,226	42,771,281
2011	5,067,140	5,699,368	10,766,508	9,423,440	5,085,756	14,437,313	28,946,510	7,056,412	35,387,966	42,444,378
2012	5,117,382	5,739,753	10,857,135	9,519,914	5,114,257	14,519,568	29,153,740	7,156,087	35,658,617	42,814,704
2013	5,165,200	5,651,821	10,817,021	9,565,395	5,385,402	14,091,819	29,042,616	7,090,691	35,631,333	42,722,024
2014	5,122,016	5,568,272	10,690,288	9,350,268	4,965,645	13,116,189	27,432,103	6,804,105	35,142,893	41,946,998
2015	5,150,084	5,565,819	10,715,903	9,373,255	4,927,696	12,869,220	27,170,171	6,831,656	35,192,779	42,024,435
2016	5,161,315	5,569,826	10,731,141	9,513,552	4,990,887	12,917,959	27,422,398	6,896,376	35,306,213	42,202,590
2017	5,147,602	5,557,491	10,705,093	9,245,614	4,857,889	12,562,870	26,666,374	6,766,874	35,069,077	41,835,951
2018	5,102,835	5,572,939	10,675,774	9,107,645	4,856,388	12,527,095	26,491,128	6,784,786	35,100,128	41,884,914
2019	5,106,303	5,594,122	10,700,425	9,303,966	4,935,667	12,692,973	26,932,606	6,902,115	35,309,361	42,211,476
2020	5,069,215	5,548,326	10,617,541	8,963,783	4,752,107	12,272,305	25,988,196	6,666,527	34,880,946	41,547,473
2021	5,078,281	5,549,680	10,627,961	8,949,410	4,745,765	12,257,335	25,952,510	6,667,072	34,881,553	41,548,626
2022	5,042,292	5,519,809	10,562,101	8,768,770	4,645,332	12,026,676	25,440,779	6,532,119	34,634,334	41,166,453
2023	5,042,510	5,485,459	10,527,968	8,850,334	4,688,501	12,127,211	25,666,047	6,564,208	34,690,084	41,254,292
2024	5,075,945	5,515,561	10,591,507	9,056,459	4,801,966	12,384,784	26,243,210	6,711,337	34,957,814	41,669,151
2025	5,056,500	5,502,742	10,559,242	8,825,030	4,679,426	12,096,581	25,601,037	6,616,331	34,785,911	41,402,242
2026	5,057,077	5,501,838	10,558,915	9,086,460	4,817,092	12,420,230	26,323,783	6,714,861	34,960,267	41,675,127
2027	5,041,010	5,488,916	10,529,926	8,919,703	4,726,842	12,211,797	25,858,342	6,626,075	34,800,661	41,426,736
2028	5,040,853	5,485,252	10,526,105	8,943,813	4,740,839	12,238,625	25,923,276	6,644,588	34,825,320	41,469,907
2029	5,024,263	5,470,802	10,495,064	8,851,388	4,689,944	12,122,513	25,663,845	6,585,252	34,716,218	41,301,470
2030	5,019,846	5,460,105	10,479,951	8,910,717	4,722,570	12,196,307	25,829,594	6,620,874	34,775,050	41,395,925
2031	4,992,814	5,431,833	10,424,647	8,759,416	4,640,030	12,006,274	25,405,720	6,538,992	34,617,868	41,156,861
2032	4,996,675	5,422,526	10,419,200	8,899,827	4,717,880	12,180,956	25,798,663	6,630,193	34,782,058	41,412,251
2033	5,021,532	5,425,647	10,447,179	9,131,458	4,847,314	12,474,426	26,453,197	6,831,835	35,155,543	41,987,378
2034	4,906,524	5,313,042	10,219,565	8,922,980	4,731,839	12,120,254	25,865,073	6,669,583	34,858,159	41,527,742
2035	4,733,828	5,143,980	9,877,808	8,908,933	4,718,195	12,187,824	25,814,952	6,627,154	34,775,304	41,402,458
TOTAL	209,006,662	241,371,165	450,377,827	361,452,779	202,438,103	575,441,788	1,139,332,670	236,309,004	1,340,989,041	1,577,298,045

**TABLE B-19. Total Transportation Charge for Each Contractor**

(in dollars)

Sheet 2 of 4

Calendar Year	SAN JOAQUIN VALLEY AREA								
	Dudley Ridge Water District	Empire West Side Irrigation District	Future Contractor San Joaquin Valley	Kern County Water Agency		County of Kings	Oak Flat Water District	Tulare Lake Basin Water Storage District	Total
				Municipal and Industrial	Agri- cultural				
	[11]	[12]	[13]	[14]	[15]	[16]	[17]	[18]	[19]
1961	0	0	0	0	0	0	0	0	0
1962	0	0	0	0	0	0	0	0	0
1963	0	0	0	0	0	0	0	0	0
1964	0	0	2,724	0	0	0	0	0	2,724
1965	0	0	6,027	73,544	0	0	0	0	79,571
1966	0	0	12,035	137,284	0	0	0	0	149,319
1967	0	0	26,249	267,525	0	0	0	0	293,774
1968	184,386	8,896	54,573	445,315	1,543,736	13,767	11,578	208,761	2,471,011
1969	179,991	7,607	87,557	524,952	2,390,757	12,621	10,580	356,519	3,570,585
1970	201,987	14,374	94,656	573,846	2,913,269	12,786	13,117	293,326	4,117,361
1971	198,233	15,332	95,676	605,729	3,821,296	17,759	14,417	448,422	5,216,864
1972	220,766	16,200	98,769	631,452	4,990,931	15,216	20,699	1,080,426	7,074,460
1973	203,326	12,271	97,531	639,086	4,923,525	15,480	11,722	408,789	6,311,729
1974	283,131	12,240	98,440	698,081	5,225,917	15,586	12,804	597,402	6,943,602
1975	350,185	13,185	106,683	715,440	6,347,523	16,616	14,488	728,097	8,292,217
1976	305,156	13,731	108,064	774,124	6,701,414	16,990	16,161	564,425	8,500,065
1977	267,133	10,841	112,534	797,692	6,876,284	18,453	13,943	511,322	8,608,201
1978	356,002	4,441	115,500	890,777	8,329,709	18,918	17,984	504,976	10,238,306
1979	386,004	13,578	114,232	896,026	9,455,230	20,198	24,916	953,823	11,864,007
1980	407,141	11,928	125,929	888,723	10,013,184	20,745	24,302	738,196	12,230,148
1981	470,632	29,769	134,147	1,079,139	11,458,806	24,935	22,962	909,544	14,129,935
1982	465,141	12,919	135,036	1,004,492	12,291,750	22,951	22,428	746,950	14,701,667
1983	638,344	14,513	149,180	1,027,082	15,600,315	39,967	29,176	428,178	17,826,754
1984	910,916	14,927	164,483	2,063,001	23,627,468	54,424	59,672	784,710	27,679,601
1985	1,099,360	87,488	184,883	2,350,412	27,934,902	69,479	70,203	2,171,193	33,967,920
1986	1,263,495	33,944	180,423	2,364,977	30,514,419	80,765	76,064	2,183,508	36,697,594
1987	1,121,968	50,739	179,850	2,804,592	29,300,470	78,014	74,312	2,242,520	35,852,464
1988	1,107,473	61,534	193,712	2,750,239	29,213,755	74,164	60,188	2,200,163	35,661,228
1989	1,142,890	49,216	187,891	2,435,448	29,276,110	67,045	68,654	2,443,547	35,670,801
1990	865,780	34,378	221,368	2,541,123	27,392,065	51,053	49,083	1,870,432	33,025,282
1991	583,037	23,283	220,258	2,055,047	17,591,457	27,925	26,852	1,230,997	21,758,857
1992	952,483	39,119	241,431	2,369,575	25,889,578	55,791	50,906	1,908,137	31,507,020
1993	1,164,773	53,646	264,933	2,799,265	31,403,747	72,885	69,589	2,641,725	38,470,563
1994	1,019,863	43,772	306,333	2,808,608	29,279,558	60,455	57,356	2,117,655	35,693,601
1995	1,516,551	46,630	304,270	3,499,388	36,403,113	88,870	80,179	2,771,765	44,710,767
1996	1,346,233	48,262	389,175	3,559,914	36,387,911	86,087	73,827	4,317,656	46,209,065
1997	1,387,762	25,419	276,653	3,107,537	32,558,840	36,710	68,687	1,671,733	39,133,340
1998	1,234,298	34,400	381,817	2,733,766	29,279,331	41,831	60,129	1,802,965	35,568,538
1999	1,190,369	53,934	366,550	3,072,609	30,638,998	73,162	62,409	4,006,863	39,464,894
2000	1,063,321	37,957	303,252	2,632,323	26,185,844	61,865	54,722	2,785,797	33,125,080
2001	1,734,531	62,876	327,961	2,594,955	33,651,178	80,081	100,887	3,057,596	41,610,064
2002	1,320,711	43,716	321,473	3,058,991	28,390,394	73,590	78,090	2,523,656	35,810,621
2003	1,384,382	48,443	339,996	3,415,345	31,257,699	89,628	78,971	2,865,946	39,480,410
2004	1,444,014	77,806	343,920	3,800,078	30,377,799	233,344	81,702	2,385,062	38,743,724
2005	2,006,888	86,642	356,712	3,240,614	40,737,558	411,733	80,313	3,389,363	50,309,823
2006	1,989,620	77,070	301,410	3,373,504	38,152,126	257,952	79,980	2,858,291	47,089,952
2007	1,630,417	70,243	346,758	3,716,442	35,119,524	235,875	83,612	2,979,738	44,182,607
2008	2,116,485	99,116	389,021	4,885,443	44,615,890	348,684	120,210	3,560,580	56,135,429
2009	2,670,956	123,752	421,926	5,923,110	52,834,590	416,292	151,396	4,304,936	66,846,959
2010	2,307,720	105,031	412,792	5,017,821	46,497,660	359,030	127,857	3,555,736	58,383,647
2011	2,207,286	100,082	421,700	5,009,587	45,796,341	350,281	130,743	3,389,114	57,405,133
2012	2,213,938	100,428	422,239	5,043,069	46,147,955	351,564	129,199	3,399,421	57,807,813
2013	2,267,838	103,246	422,893	6,868,159	47,002,800	360,373	136,257	3,482,982	60,644,548
2014	1,962,566	87,273	420,461	5,904,050	42,172,796	310,672	111,159	3,009,574	53,978,552
2015	2,032,271	90,917	417,387	5,993,181	43,229,396	321,992	118,068	3,117,651	55,320,863
2016	2,158,775	97,539	411,000	6,287,347	45,267,196	342,563	129,428	3,313,853	58,007,702
2017	2,039,536	91,300	396,938	5,814,096	43,319,737	323,137	118,933	3,128,936	55,232,613
2018	2,050,421	91,867	374,457	5,804,196	43,686,925	315,588	118,247	3,145,787	55,587,488
2019	2,180,421	98,671	365,600	6,088,067	45,756,619	336,063	130,002	3,347,415	58,302,858
2020	2,058,004	92,265	364,069	5,693,509	43,677,984	315,634	120,063	3,157,565	55,479,094
2021	2,047,354	91,708	363,121	5,652,051	43,533,861	313,751	118,853	3,141,044	55,261,743
2022	1,977,251	88,039	362,400	5,439,503	42,349,632	302,130	113,045	3,032,328	53,664,329
2023	2,035,105	91,070	361,709	5,584,299	43,248,719	311,501	118,558	3,122,076	54,873,036
2024	2,121,655	95,596	361,294	5,820,885	44,680,870	325,676	125,963	3,256,276	56,788,215
2025	1,974,720	87,906	361,052	5,464,212	42,439,214	301,743	111,669	3,028,401	53,768,918
2026	2,152,049	97,189	360,212	5,882,620	45,121,718	330,518	129,119	3,303,426	57,376,851
2027	2,057,557	92,237	360,561	5,653,292	43,681,988	315,039	119,989	3,156,824	55,437,486
2028	2,069,989	92,895	357,101	5,671,235	43,843,389	316,993	121,353	3,176,174	55,649,129
2029	2,029,928	90,796	357,208	5,567,899	43,213,960	310,360	117,666	3,114,027	54,801,844
2030	2,061,780	92,465	356,632	5,634,143	43,688,931	315,500	120,846	3,163,445	55,433,743
2031	1,983,762	88,373	356,014	5,434,496	42,512,399	302,344	113,258	3,042,376	53,833,022
2032	2,050,532	91,879	354,729	5,586,787	43,513,724	313,307	119,691	3,146,016	55,176,665
2033	2,130,821	96,075	355,034	5,895,465	45,070,237	326,455	124,691	3,270,485	57,269,263
2034	2,053,185	92,012	354,456	5,607,254	43,635,722	313,509	119,269	3,150,083	55,325,490
2035	2,119,139	95,467	353,091	5,892,689	44,875,591	323,877	123,804	3,252,042	57,036,060
<b>TOTAL</b>	<b>94,729,736</b>	<b>4,082,463</b>	<b>19,096,146</b>	<b>240,936,524</b>	<b>2,088,763,333</b>	<b>11,940,299</b>	<b>5,367,000</b>	<b>159,959,107</b>	<b>2,624,874,609</b>

**TABLE B-19. Total Transportation Charge for Each Contractor**

(in dollars)

Sheet 3 of 4

Calendar Year	SOUTHERN CALIFORNIA AREA									
	Antelope Valley-East Kern Water Agency	Castaic Lake Water Agency	Coachella Valley Water District	Crestline - Lake Arrowhead Water Agency	Desert Water Agency	Littlerock Creek Irrigation District	Mojave Water Agency	Palmdale Water District	San Bernardino Valley Municipal Water District	San Gabriel Valley Municipal Water District
	[20]	[21]	[22]	[23]	[24]	[25]	[26]	[27]	[28]	[29]
1961	0	0	0	0	0	0	0	0	0	0
1962	0	0	0	0	0	0	0	0	0	0
1963	33,772	0	0	0	0	0	0	0	51,711	0
1964	63,539	27,438	16,286	4,368	37,145	1,142	28,427	8,202	82,782	34,973
1965	119,810	52,989	28,459	7,191	40,756	2,081	50,300	15,217	135,023	35,333
1966	217,978	101,232	51,184	12,474	73,129	3,752	90,369	27,670	232,426	61,445
1967	421,745	210,746	98,904	23,464	141,365	7,282	175,119	54,006	433,210	115,536
1968	743,770	478,142	176,688	41,496	251,125	12,866	311,125	95,438	781,930	208,864
1969	1,072,210	724,370	264,900	61,208	370,850	18,688	459,029	138,023	1,205,471	321,659
1970	1,395,411	904,254	371,728	89,673	519,163	25,223	633,101	184,783	1,777,649	467,431
1971	1,727,337	1,088,091	503,422	128,321	712,537	31,827	857,295	231,214	2,537,458	659,218
1972	2,046,595	1,306,970	640,299	181,162	925,397	42,393	1,111,961	274,527	3,387,842	864,867
1973	2,137,697	1,323,033	777,545	183,667	1,136,869	43,472	1,175,162	287,241	3,970,608	946,446
1974	2,201,565	1,382,453	794,192	193,237	1,163,708	45,201	1,207,271	291,996	3,997,546	989,818
1975	2,378,538	1,450,483	836,481	205,992	1,231,490	48,479	1,274,474	304,204	4,158,104	1,088,088
1976	2,731,790	1,445,830	883,730	215,036	1,307,153	51,452	1,317,147	313,608	4,298,577	1,141,338
1977	2,674,654	1,514,902	780,142	225,984	1,144,829	47,338	1,389,054	329,288	4,552,801	1,196,952
1978	2,992,385	1,599,693	961,523	230,990	1,420,338	47,108	1,389,248	321,604	4,459,127	1,208,453
1979	3,545,984	1,634,280	1,029,691	237,905	1,518,496	48,384	1,516,868	332,394	4,421,335	1,152,106
1980	4,092,638	1,715,928	1,119,626	259,351	1,679,613	53,338	1,636,359	360,382	4,834,599	1,269,177
1981	4,423,088	1,969,527	1,195,134	271,128	1,797,033	77,794	1,756,820	391,786	5,223,096	1,357,401
1982	3,985,592	2,061,166	1,245,674	280,261	1,883,312	95,949	1,953,329	406,809	5,409,792	1,564,903
1983	5,176,411	2,323,365	1,837,054	333,027	2,827,158	69,370	2,027,448	494,603	6,019,822	1,556,367
1984	7,212,364	3,365,043	2,920,693	445,283	4,553,156	75,761	2,255,087	553,232	7,048,308	2,331,555
1985	8,927,864	3,749,417	3,717,539	540,331	5,827,873	79,219	2,365,603	758,960	7,739,192	2,378,093
1986	8,826,853	4,316,983	4,143,184	577,416	6,515,636	102,386	2,474,884	999,968	7,856,385	3,047,434
1987	8,843,579	4,157,601	3,998,374	604,923	6,363,049	121,795	2,507,329	1,026,303	9,223,407	3,033,831
1988	8,318,460	4,220,880	3,997,055	615,940	6,426,199	124,654	2,561,860	779,724	9,504,046	2,828,684
1989	8,695,508	4,100,760	3,641,415	586,536	5,896,166	170,557	2,509,226	1,442,530	8,943,405	2,930,080
1990	9,983,550	4,541,155	4,316,516	620,333	6,956,699	289,335	2,704,863	1,639,730	9,793,777	3,677,786
1991	6,484,309	3,510,081	2,823,346	567,387	4,492,594	175,123	3,463,976	1,294,508	8,920,573	3,035,311
1992	8,585,236	4,467,640	2,894,932	470,101	4,609,710	121,321	4,265,399	1,129,477	8,572,065	2,979,755
1993	8,968,863	4,099,050	3,092,789	472,751	4,934,951	157,733	4,144,258	1,347,409	9,504,354	3,191,667
1994	11,155,716	4,711,258	3,137,403	554,582	5,006,990	225,795	5,137,306	1,698,886	10,207,695	4,076,345
1995	10,756,902	4,969,094	3,910,360	509,093	6,281,228	155,546	4,225,003	1,527,143	9,441,804	3,715,006
1996	11,125,701	5,157,169	6,847,257	553,160	11,124,041	150,598	4,291,851	1,867,098	9,867,870	3,807,043
1997	11,375,990	4,923,887	6,408,674	579,209	7,362,617	144,818	4,595,294	1,869,201	11,265,726	4,037,468
1998	9,918,085	4,562,912	5,509,267	546,671	5,889,473	146,239	5,632,917	1,477,821	11,186,570	3,323,584
1999	11,325,867	4,898,513	4,454,514	634,698	5,920,525	145,123	5,826,394	1,838,741	12,276,237	4,163,280
2000	10,586,292	6,860,303	2,880,830	596,269	4,305,160	115,235	5,667,754	1,454,427	11,885,604	3,259,920
2001	20,757,386	12,548,658	3,936,492	802,460	6,319,259	127,739	6,383,102	3,369,947	17,884,134	3,413,193
2002	12,051,056	9,752,983	3,190,160	764,554	5,088,279	109,686	5,515,025	2,762,720	18,763,369	4,822,106
2003	13,426,778	10,664,225	3,307,875	734,431	5,281,322	115,136	7,180,362	2,297,100	17,052,818	4,969,028
2004	14,141,980	11,819,726	3,895,050	828,218	5,258,278	124,052	7,256,191	2,506,566	21,141,363	4,362,185
2005	14,830,721	10,888,025	17,845,326	603,940	10,235,031	120,274	7,156,918	2,587,357	19,697,717	4,694,620
2006	15,614,786	10,463,556	26,662,475	622,386	9,712,651	117,713	9,706,626	2,417,219	19,265,529	4,541,965
2007	19,353,647	13,612,388	25,927,376	940,988	9,372,050	116,984	13,849,381	3,498,251	26,147,377	3,947,012
2008	22,611,152	15,475,085	33,364,686	1,475,778	11,978,927	500,780	14,664,146	4,574,470	35,529,518	6,369,233
2009	24,570,659	16,164,632	46,451,397	1,566,002	17,600,059	670,272	16,647,978	6,146,158	42,962,040	10,575,073
2010	20,977,351	14,387,868	44,592,261	1,407,153	15,117,470	562,442	14,461,410	5,117,458	37,304,538	9,042,330
2011	23,040,346	14,748,671	49,423,346	1,463,777	16,355,142	624,423	15,176,999	5,703,038	38,822,030	9,477,243
2012	24,442,699	15,588,057	51,415,553	1,542,659	17,053,708	654,990	15,785,203	5,985,830	40,169,264	9,862,258
2013	32,399,737	17,297,065	51,013,081	1,523,219	16,874,041	651,839	16,464,676	5,956,236	39,571,942	9,715,838
2014	34,074,693	22,175,561	45,234,428	1,835,595	14,845,645	564,632	22,691,980	5,149,946	35,816,258	8,624,508
2015	34,194,832	22,274,681	45,384,992	1,816,888	14,856,147	566,566	22,775,742	5,168,934	35,446,767	8,558,820
2016	35,553,939	23,124,889	46,707,267	1,906,154	15,377,533	588,582	23,679,059	5,374,825	36,955,434	8,940,528
2017	33,878,588	22,064,290	45,133,560	1,810,351	14,730,467	561,125	22,621,145	5,124,743	35,286,159	8,501,693
2018	35,190,990	22,781,749	46,182,485	1,869,484	15,146,464	582,187	23,581,548	5,324,021	36,217,962	8,760,438
2019	35,956,119	23,062,341	47,249,258	1,915,082	15,492,295	594,140	23,916,146	5,439,394	36,988,174	8,962,582
2020	33,937,222	21,712,633	44,338,809	1,789,623	14,483,700	560,032	22,708,186	5,129,805	34,607,960	8,334,478
2021	33,744,821	21,481,329	43,912,745	1,742,957	14,280,896	555,721	22,525,374	5,096,720	33,740,868	8,134,576
2022	32,725,224	20,668,084	42,374,716	1,697,607	13,786,145	538,882	21,827,812	4,942,524	32,869,306	7,880,969
2023	33,063,787	20,934,507	41,685,138	1,724,755	13,758,035	544,197	22,041,377	4,992,991	33,234,436	7,963,517
2024	33,952,427	21,499,499	42,752,928	1,747,686	14,116,856	558,647	22,537,153	5,126,863	33,649,107	8,110,952
2025	33,391,140	21,076,906	41,857,831	1,722,131	13,858,299	549,487	22,229,697	5,042,267	33,220,146	7,987,669
2026	33,892,058	21,509,594	42,703,483	1,759,941	14,084,960	557,590	22,507,360	5,117,677	33,778,371	8,121,006
2027	33,569,569	21,051,618	41,721,450	1,720,735	13,843,713	552,339	22,296,714	5,069,153	33,116,853	7,968,524
2028	33,410,422	21,272,371	41,828,256	1,703,485	13,802,009	549,723	22,200,680	5,045,223	32,778,450	7,890,215
2029	33,181,156	20,822,545	41,562,069	1,720,012	13,740,206	545,973	22,048,454	5,010,797	33,086,942	7,935,203
2030	33,134,995	20,844,872	41,559,847	1,720,747	13,734,158	545,205	22,023,466	5,004,084	33,100,477	7,933,945
2031	32,885,423	20,443,772	41,364,410	1,662,268	13,565,940	541,119	21,915,509	4,967,038	32,090,625	7,712,347
2032	32,928,223	20,722,845	41,074,377	1,704,943	13,608,745	541,783	21,860,163	4,973,810	32,871,483	7,874,328
2033	35,400,609	22,143,010	43,951,978	1,800,231	14,560,077	581,959	23,531,407	5,347,694	34,452,630	8,348,198
2034	33,229,340	20,779,048	41,611,727	1,694,954	13,726,888	546,637	22,108,418	5,022,824	32,705,570	7,863,457
2035	35,987,356	21,907,040	44,464,080	1,853,420	14,725,162	591,388	23,725,018	5,440,249	35,328,144	8,531,292
<b>TOTAL</b>	<b>1,201,774,881</b>	<b>747,690,759</b>	<b>1,397,987,723</b>	<b>65,855,231</b>	<b>583,018,091</b>	<b>20,138,622</b>	<b>732,589,333</b>	<b>193,402,082</b>	<b>1,350,870,612</b>	<b>338,916,546</b>



**TABLE B-19. Total Transportation Charge for Each Contractor**

(in dollars)

Sheet 4 of 4

Calendar Year	SOUTHERN CALIFORNIA AREA (continued)				FEATHER RIVER AREA				South Bay Area Future Contractor	GRAND TOTAL
	San Geronio Pass Water Agency	The Metropolitan Water District of Southern California	Ventura County Watershed Protection District	Total	City of Yuba City	County of Butte	Plumas County FC&WCD	Total		
	[30]	[31]	[32]	[33]	[34]	[35]	[36]	[37]	[38]	[39]
1961	0	0	0	0	0	0	0	0	0	0
1962	0	0	0	0	0	0	0	0	3,219	79,888
1963	0	690,539	0	776,021	0	0	0	0	12,626	1,626,150
1964	21,728	1,260,042	9,374	1,595,448	0	0	0	0	13,938	2,802,244
1965	21,859	2,179,810	17,760	2,706,589	0	0	405	405	28,937	4,801,023
1966	37,952	3,898,819	33,415	4,841,844	0	0	564	564	31,321	7,382,540
1967	71,260	7,691,085	68,133	9,511,856	0	0	562	562	47,718	12,793,177
1968	128,877	15,313,065	142,760	18,686,147	0	0	564	564	46,945	24,930,696
1969	198,704	23,145,744	215,144	28,195,999	0	0	3,190	3,190	52,963	36,030,360
1970	289,546	30,607,434	273,523	37,538,920	0	0	15,116	15,116	69,744	46,163,855
1971	409,205	39,946,463	342,325	49,174,713	0	0	15,996	15,996	55,532	58,794,979
1972	537,044	52,933,606	422,192	64,674,856	0	0	17,367	17,367	80,412	76,515,381
1973	587,814	57,257,279	435,541	70,262,374	0	0	17,328	17,328	54,219	81,189,340
1974	611,275	61,759,841	455,447	75,093,549	0	0	17,472	17,472	76,783	86,909,157
1975	644,464	66,739,819	478,284	80,838,889	0	0	18,400	18,400	84,547	94,056,827
1976	668,153	68,467,779	475,466	83,317,059	0	0	17,471	17,471	106,717	97,123,393
1977	696,350	66,216,668	506,941	81,275,903	0	0	18,227	18,227	98,618	95,159,583
1978	708,874	72,917,066	523,053	88,779,461	0	0	17,375	17,375	100,786	104,645,013
1979	712,699	72,648,617	526,278	89,325,037	0	0	20,573	20,573	119,352	106,991,314
1980	777,814	79,908,126	571,100	98,278,049	0	0	17,755	17,755	178,812	116,945,923
1981	805,858	91,241,966	636,261	111,146,892	0	0	21,188	21,188	185,347	131,717,455
1982	853,227	93,125,063	670,228	113,495,304	0	0	28,417	28,417	173,894	135,094,538
1983	951,954	101,767,502	803,439	126,187,520	0	0	19,271	19,271	220,926	151,584,878
1984	1,072,455	137,486,443	868,812	170,188,193	0	0	21,109	21,109	225,959	208,157,155
1985	1,120,667	172,895,309	908,613	211,008,681	0	0	20,233	20,233	340,322	257,868,645
1986	1,149,524	193,220,922	937,154	234,168,730	0	0	20,134	20,134	279,227	284,228,684
1987	1,171,823	178,743,184	907,876	220,793,074	0	0	19,736	19,736	345,116	272,463,293
1988	1,208,011	190,222,146	904,709	231,712,366	0	0	17,895	17,895	365,207	284,536,514
1989	1,194,715	193,213,771	932,440	234,256,749	0	0	19,153	19,153	422,329	287,610,923
1990	1,297,422	239,518,615	1,486,593	286,826,374	0	0	18,143	18,143	474,284	339,747,639
1991	1,354,718	179,928,886	1,140,954	217,191,766	0	0	21,012	21,012	214,683	255,485,479
1992	1,348,976	196,144,526	1,025,119	236,614,256	0	0	18,008	18,008	286,170	270,229,229
1993	1,507,337	169,470,518	1,067,967	212,087,647	0	0	20,993	20,993	599,571	270,962,112
1994	1,497,529	209,259,636	1,008,783	257,677,924	0	0	19,644	19,644	609,966	316,359,349
1995	1,520,392	173,396,660	1,061,154	221,469,384	0	0	20,272	20,272	534,971	290,081,441
1996	1,526,936	181,380,152	1,103,083	238,801,959	0	0	25,373	25,373	571,857	319,194,301
1997	1,731,237	186,712,246	1,216,389	242,222,755	0	0	24,815	24,815	428,638	323,446,047
1998	1,924,943	168,700,865	1,238,198	220,057,545	0	0	17,366	17,366	465,095	302,430,048
1999	2,167,880	189,824,243	1,251,210	244,727,225	0	0	17,366	17,366	559,471	335,401,734
2000	2,426,413	185,909,773	1,321,674	237,269,653	0	0	17,367	17,367	0	322,062,490
2001	3,389,196	377,136,900	1,618,687	457,687,152	0	0	17,368	17,368	0	560,514,119
2002	4,797,483	266,689,838	1,651,146	335,958,404	0	0	17,369	17,369	0	437,269,093
2003	5,898,251	294,190,020	1,671,283	366,788,629	0	0	20,763	20,763	0	467,712,251
2004	6,361,346	338,683,168	1,900,990	418,279,113	0	0	20,825	20,825	0	517,578,025
2005	6,703,598	312,968,157	1,417,670	409,749,355	0	0	20,822	20,822	0	520,733,039
2006	7,206,871	296,093,004	1,380,707	403,805,217	0	0	21,349	21,349	0	510,780,343
2007	8,119,305	380,923,033	1,879,193	507,686,986	0	0	21,325	21,325	0	618,002,562
2008	10,425,223	501,792,052	4,237,535	662,998,585	0	0	20,583	20,583	1	793,640,828
2009	13,670,178	541,646,130	5,837,209	744,507,788	0	0	19,206	19,206	2	896,598,531
2010	12,309,754	458,620,572	4,872,396	638,773,003	0	0	19,296	19,296	0	777,946,152
2011	12,674,023	486,892,135	5,178,407	679,579,581	0	0	22,074	22,074	0	819,164,184
2012	12,904,453	506,864,278	5,428,801	707,697,754	0	0	22,074	22,074	0	848,353,219
2013	12,584,183	491,059,134	5,426,949	691,537,491	0	0	22,074	22,074	0	834,785,774
2014	11,703,797	470,479,280	4,779,901	677,976,224	0	0	22,073	22,073	0	812,046,238
2015	11,632,472	470,849,870	4,798,145	678,324,854	0	0	21,671	21,671	0	813,577,896
2016	11,861,026	488,658,597	4,986,275	703,714,108	0	0	21,508	21,508	0	842,099,446
2017	11,591,883	466,180,092	4,744,540	672,228,636	0	0	21,511	21,511	0	806,690,178
2018	11,727,956	478,316,286	4,905,492	690,587,064	0	0	21,510	21,510	0	825,247,878
2019	11,849,763	485,939,596	4,967,964	702,332,855	0	0	18,878	18,878	0	840,499,099
2020	11,467,105	454,637,991	4,663,297	658,370,840	0	0	6,958	6,958	0	792,010,102
2021	11,347,792	446,709,110	4,607,309	647,880,219	0	0	6,135	6,135	0	781,277,194
2022	11,195,106	430,014,148	4,427,068	624,947,592	0	0	4,746	4,746	0	755,785,999
2023	11,240,651	433,616,492	4,484,305	629,284,188	0	0	4,745	4,745	0	761,610,277
2024	11,321,175	444,264,364	4,608,730	644,246,385	0	0	4,744	4,744	0	779,543,211
2025	11,237,424	434,208,275	4,513,522	630,894,796	0	0	4,746	4,746	0	762,230,980
2026	11,320,550	444,245,802	4,607,974	644,206,365	0	0	4,735	4,735	0	780,145,777
2027	11,225,819	432,051,543	4,503,474	628,691,505	0	0	4,750	4,750	0	761,948,745
2028	11,175,531	438,592,800	4,562,356	634,811,520	0	0	4,731	4,731	0	768,384,668
2029	11,208,029	429,567,577	4,455,657	624,894,621	0	0	4,736	4,736	0	757,161,582
2030	11,205,828	430,401,201	4,459,924	625,668,749	0	0	4,733	4,733	0	758,812,695
2031	11,064,832	419,369,672	4,367,752	611,950,707	0	0	4,743	4,743	0	742,775,699
2032	11,169,196	429,115,337	4,438,920	622,884,154	0	0	4,722	4,722	0	755,695,655
2033	11,449,895	453,556,283	4,747,931	659,871,905	0	0	4,732	4,732	0	796,033,654
2034	11,157,720	427,436,998	4,444,911	622,328,492	0	0	4,730	4,730	0	755,271,093
2035	11,567,073	456,320,769	4,721,097	665,162,086	0	0	4,719	4,719	0	799,298,084
<b>TOTAL</b>	<b>402,720,120</b>	<b>19,273,834,731</b>	<b>170,284,913</b>	<b>26,479,083,643</b>	<b>0</b>	<b>0</b>	<b>1,077,546</b>	<b>1,077,546</b>	<b>8,723,731</b>	<b>32,280,768,071</b>

**TABLE B-20A: CALCULATION OF DELTA WATER RATES**

**Calculation in accordance with Article 53(i) of the Monterey Amendment**

(Values in millions of dollars [\$] or millions of acre-feet [AF] discounted to 2008 at 4.608 percent per annum)

Procedure	Capital Cost Component		Minimum Operation, Maintenance, Power and Replacement Component (a)		Total Delta Water Rate	
	[ 1 ]		[ 2 ]		[ 3 ]	
<b>Commencing in 2009</b>						
Total Costs of "Initial" Project Conservation Facilities to be Reimbursed and Project Water Entitlements during the Project Repayment Period.	\$5,442.95 (b)	324.95 AF	\$3,921.62 (c)	324.95 AF	\$9,364.57	324.95 AF
Less, Project Power Revenues to be Realized During the Project Repayment Period.	(1,913.37)		(782.17)		(\$2,695.53)	
Less, Delta Water Charges Paid and Project Water Entitlements, Prior to 2009	(2,541.45) (d)	(261.26) AF	(1,900.33)	(261.26) AF	(\$4,441.78)	(261.26) AF
<b>TOTAL</b>	<b>\$988.14</b>	<b>63.68 AF</b>	<b>\$1,239.12</b>	<b>63.68 AF</b>	<b>\$2,227.26</b>	<b>63.68 AF</b>
Rate Applicable in 2009	\$15.52 per acre-foot		\$19.46 per acre-foot		\$34.97 per acre-foot	

**Calculation under original provisions, without the Monterey Amendment**

(for Plumas County, and Empire)

Procedure	Capital Cost Component		Minimum Operation, Maintenance, Power and Replacement Component (a)		Total Delta Water Rate	
	[ 4 ]		[ 5 ]		[ 6 ]	
<b>Commencing in 2009</b>						
Total Costs of "Initial" Project Conservation Facilities to be Reimbursed and Project Water Entitlements during the Project Repayment Period.	\$5,429.89 (b)	324.95 AF	\$3,905.29 (c)	324.95 AF	\$9,335.18	324.95 AF
Less, Project Power Revenues to be Realized During the Project Repayment Period.	(1,913.37)		(782.17)		(\$2,695.53)	
Less, Delta Water Charges Paid and Project Water Entitlements, Prior to 2009	(2,541.45) (d)	(261.26) AF	(1,900.33)	(261.26) AF	(\$4,441.78)	(261.26) AF
<b>TOTAL</b>	<b>\$975.07</b>	<b>63.68 AF</b>	<b>\$1,222.80</b>	<b>63.68 AF</b>	<b>\$2,197.87</b>	<b>63.68 AF</b>
Rate Applicable in 2009	\$15.31 per acre-foot		\$19.20 per acre-foot		\$34.51 per acre-foot	

a) Considering that all operating costs of Project Conservation Facilities will not vary with annual amounts of Project water delivered, and therefore are properly classified as "Minimum" OMP&R Costs. OMP&R costs exclude amounts for Conservaton RAS.

b) Including net credits of \$4,850,000 for settlements as to the magnitude of Project Capital costs incurred prior to December 31, 1960, and net credits of \$6,678,320 for settlement as to the magnitude of Project Capital costs incurred during the 1961 through 1978 period.

c) Includes conservation power costs and credits at San Luis.

d) Applying all Delta Water Charges paid prior to 1970 to reimburse Capital costs (the charge was not divided into components until 1970).

**TABLE B-20B. DELTA WATER RATES BY FACILITY**

(in dollars per acre-foot)

Item	Capital Cost Component	Minimum Operation, Maintenance, Power and Replacement Component	Total Delta Water Rate
	[1]	[2]	[3]
<b>Initial Conservation Facilities</b>			
Oroville Division			
Water Supply and power costs (a)	50.52	28.52	79.04
Less, Oroville Power Revenues	<u>-30.04</u>	<u>-12.28</u>	<u>-42.33</u>
Subtotal	20.48	16.24	36.72
Delta Facilities (b)			
California Aqueduct, portion	16.94	18.21	35.15
Reach 1	3.20	5.14	8.34
Reach 2A	1.91	0.84	2.74
Reach 2B	0.99	0.48	1.47
Reach 3	<u>0.68</u>	<u>0.27</u>	<u>0.95</u>
Subtotal	6.78	6.73	13.51
San Luis Facilities	9.59	7.86	17.45
Planning and preoperating costs through 2007	2.77	0.00	2.77
45,000 AF relinquished costs	0.21	0.26	0.46
Less, Capital Cost Credits	-1.34	0.00	-1.34
Less, Delta Water Charges paid prior to 2009	<u>-39.91</u>	<u>-29.84</u>	<u>-69.75</u>
Rate applicable in 2009	15.52	19.46	34.97

a) Includes revenue received from non-contractors.

b) Includes (1) Delta Facility planning costs, (2) Delta Studies costs, and (3) Suisun Marsh Facilities Costs.

**TABLE B-21. Total Delta Water Charge for Each Contractor**

(in dollars)

Sheet 1 of 4

Calendar Year	NORTH BAY AREA			SOUTH BAY AREA				CENTRAL COASTAL AREA		
	Napa County FC&WCD	Solano County WA	Total	Alameda County FC&WCD, Zone 7	Alameda County Water District	Santa Clara Valley Water District	Total	San Luis Obispo County FC&WCD	Santa Barbara County FC&WCD	Total
	[1]	[2]	[3]	[4]	[5]	[6]	[7]	[8]	[9]	[10]
1964	0	0	0	0	0	0	0	0	0	0
1965	0	0	0	0	0	0	0	0	0	0
1966	0	0	0	0	0	0	0	0	0	0
1967	0	0	0	14,000	50,050	177,100	241,150	0	0	0
1968	0	0	0	19,156	29,701	193,245	242,102	0	0	0
1969	0	0	0	30,324	44,096	215,483	289,903	0	0	0
1970	0	0	0	80,908	107,730	585,200	773,838	0	0	0
1971	0	0	0	57,320	123,080	637,120	817,520	0	0	0
1972	0	0	0	99,668	143,877	707,328	950,873	0	0	0
1973	0	0	0	120,880	167,099	782,167	1,070,146	0	0	0
1974	0	0	0	137,684	182,339	818,664	1,138,687	0	0	0
1975	0	0	0	146,204	187,324	804,123	1,137,651	0	0	0
1976	0	0	0	168,489	208,652	862,036	1,239,177	0	0	0
1977	0	0	0	172,931	208,645	827,062	1,208,638	0	0	0
1978	0	0	0	206,378	243,231	926,594	1,376,203	0	0	0
1979	0	0	0	237,771	273,208	1,005,955	1,516,934	0	0	0
1980	0	18,325	18,325	272,717	307,426	1,090,867	1,671,010	12,396	3,479	15,875
1981	0	25,440	25,440	415,564	469,768	1,589,984	2,475,316	18,068	10,414	28,482
1982	0	34,917	34,917	457,988	519,053	1,679,289	2,656,330	38,166	99,788	137,954
1983	0	12,035	12,035	316,703	359,775	1,114,795	1,791,273	38,004	68,902	106,906
1984	0	22,453	22,453	334,587	380,914	1,132,448	1,847,949	57,909	105,498	163,407
1985	0	22,001	22,001	381,970	435,728	1,244,939	2,062,637	106,103	192,937	299,040
1986	35,358	21,767	57,125	423,378	485,372	1,330,615	2,239,365	151,206	275,347	426,553
1987	0	22,984	22,984	430,024	493,786	1,304,900	2,228,710	185,355	336,664	522,019
1988	88,878	150,466	239,344	464,114	533,731	1,361,400	2,359,245	239,792	436,607	676,399
1989	102,688	305,328	408,016	513,853	591,760	1,491,833	2,597,446	331,518	602,402	933,920
1990	112,723	355,132	467,855	534,787	616,676	1,537,512	2,688,975	417,802	760,166	1,177,968
1991	129,296	395,515	524,811	603,028	681,067	1,667,194	2,951,289	443,403	806,745	1,250,148
1992	158,879	489,808	648,687	729,545	808,579	1,945,453	3,483,577	506,628	921,780	1,428,408
1993	172,457	530,778	703,235	771,894	840,958	1,990,673	3,603,525	507,825	923,957	1,431,782
1994	177,824	546,610	724,434	778,647	817,579	1,946,615	3,542,841	486,654	885,437	1,372,091
1995	203,738	713,497	917,235	874,946	874,946	2,083,205	3,833,097	520,801	947,567	1,468,368
1996	213,506	774,152	987,658	901,129	860,168	2,048,020	3,809,317	512,005	931,562	1,443,567
1997	250,558	866,141	1,116,699	1,041,633	951,056	2,264,420	4,257,109	566,105	1,029,994	1,596,099
1998	266,952	882,469	1,149,421	1,048,658	957,470	2,279,691	4,285,819	141,683	888,760	1,030,443
1999	290,688	923,459	1,214,147	1,084,480	990,178	2,357,566	4,432,224	589,391	1,072,362	1,661,753
2000	390,936	948,784	1,339,720	1,628,402	1,005,778	2,394,709	5,028,889	598,677	1,089,257	1,687,934
2001	496,412	1,097,880	1,594,292	1,868,283	1,005,998	2,395,234	5,269,515	598,809	1,089,496	1,688,305
2002	512,928	1,125,429	1,638,357	1,896,134	1,020,996	2,430,942	5,348,072	607,736	1,105,738	1,713,474
2003	511,059	1,112,692	1,623,751	1,856,232	999,510	2,379,785	5,235,527	594,946	1,082,469	1,677,415
2004	515,037	1,323,518	1,838,555	1,848,004	990,002	2,357,148	5,195,154	589,286	1,072,172	1,661,458
2005	544,123	1,156,941	1,701,064	1,973,748	1,028,262	2,448,242	5,450,252	612,060	1,113,607	1,725,667
2006	559,368	1,173,458	1,732,826	1,999,809	1,041,839	2,480,569	5,522,217	620,142	1,128,312	1,748,454
2007	623,728	1,291,247	1,914,975	2,198,222	1,145,206	2,726,679	6,070,107	681,671	1,240,257	1,921,928
2008	647,090	1,322,240	1,969,330	2,248,611	1,171,457	2,789,182	6,209,250	697,296	1,268,687	1,965,983
2009	822,753	1,659,706	2,482,459	2,819,535	1,468,890	3,497,358	7,785,783	874,339	1,590,808	2,465,147
2010	834,120	1,661,455	2,495,575	2,819,535	1,468,890	3,497,358	7,785,783	874,339	1,590,808	2,465,147
2011	845,486	1,663,203	2,508,689	2,819,535	1,468,890	3,497,358	7,785,783	874,339	1,590,808	2,465,147
2012	856,853	1,664,952	2,521,805	2,819,535	1,468,890	3,497,358	7,785,783	874,339	1,590,808	2,465,147
2013	866,470	1,666,701	2,533,171	2,819,535	1,468,890	3,497,358	7,785,783	874,339	1,590,808	2,465,147
2014	879,585	1,668,450	2,548,035	2,819,535	1,468,890	3,497,358	7,785,783	874,339	1,590,808	2,465,147
2015	903,193	1,670,198	2,573,391	2,819,535	1,468,890	3,497,358	7,785,783	874,339	1,590,808	2,465,147
2016	925,051	1,670,198	2,595,249	2,819,535	1,468,890	3,497,358	7,785,783	874,339	1,590,808	2,465,147
2017	946,910	1,670,198	2,617,108	2,819,535	1,468,890	3,497,358	7,785,783	874,339	1,590,808	2,465,147
2018	968,768	1,670,198	2,638,966	2,819,535	1,468,890	3,497,358	7,785,783	874,339	1,590,808	2,465,147
2019	990,627	1,670,198	2,660,825	2,819,535	1,468,890	3,497,358	7,785,783	874,339	1,590,808	2,465,147
2020	1,011,611	1,670,198	2,681,809	2,819,535	1,468,890	3,497,358	7,785,783	874,339	1,590,808	2,465,147
2021	1,015,108	1,670,198	2,685,306	2,819,535	1,468,890	3,497,358	7,785,783	874,339	1,590,808	2,465,147
2022	1,015,108	1,670,198	2,685,306	2,819,535	1,468,890	3,497,358	7,785,783	874,339	1,590,808	2,465,147
2023	1,015,108	1,670,198	2,685,306	2,819,535	1,468,890	3,497,358	7,785,783	874,339	1,590,808	2,465,147
2024	1,015,108	1,670,198	2,685,306	2,819,535	1,468,890	3,497,358	7,785,783	874,339	1,590,808	2,465,147
2025	1,015,108	1,670,198	2,685,306	2,819,535	1,468,890	3,497,358	7,785,783	874,339	1,590,808	2,465,147
2026	1,015,108	1,670,198	2,685,306	2,819,535	1,468,890	3,497,358	7,785,783	874,339	1,590,808	2,465,147
2027	1,015,108	1,670,198	2,685,306	2,819,535	1,468,890	3,497,358	7,785,783	874,339	1,590,808	2,465,147
2028	1,015,108	1,670,198	2,685,306	2,819,535	1,468,890	3,497,358	7,785,783	874,339	1,590,808	2,465,147
2029	1,015,108	1,670,198	2,685,306	2,819,535	1,468,890	3,497,358	7,785,783	874,339	1,590,808	2,465,147
2030	1,015,108	1,670,198	2,685,306	2,819,535	1,468,890	3,497,358	7,785,783	874,339	1,590,808	2,465,147
2031	1,015,108	1,670,198	2,685,306	2,819,535	1,468,890	3,497,358	7,785,783	874,339	1,590,808	2,465,147
2032	1,015,108	1,670,198	2,685,306	2,819,535	1,468,890	3,497,358	7,785,783	874,339	1,590,808	2,465,147
2033	1,015,108	1,670,198	2,685,306	2,819,535	1,468,890	3,497,358	7,785,783	874,339	1,590,808	2,465,147
2034	1,015,108	1,670,198	2,685,306	2,819,535	1,468,890	3,497,358	7,785,783	874,339	1,590,808	2,465,147
2035	1,015,108	1,670,198	2,685,306	2,819,535	1,468,890	3,497,358	7,785,783	874,339	1,590,808	2,465,147
TOTAL	33,082,273	62,724,091	95,806,364	107,516,248	64,014,100	158,834,652	330,365,000	35,078,590	64,442,179	99,520,769

**TABLE B-21. Total Delta Water Charge for Each Contractor**

(in dollars)

Sheet 2 of 4

Calendar Year	SAN JOAQUIN VALLEY AREA								
	Dudley Ridge Water District	Empire West Side Irrigation District	Future Contractor San Joaquin Valley	Kern County Water Agency		County of Kings	Oak Flat Water District	Tulare Lake Basin Water Storage District	Total
				Municipal and Industrial	Agri-cultural				
	[11]	[12]	[13]	[14]	[15]	[16]	[17]	[18]	[19]
1964	0	0	0	0	0	0	0	0	0
1965	0	0	0	0	0	0	0	0	0
1966	0	0	0	0	0	0	0	0	0
1967	0	0	0	0	0	0	0	0	0
1968	40,695	10,469	0	0	165,522	3,177	8,073	98,608	326,544
1969	61,267	3,281	0	0	337,686	4,200	8,805	102,478	517,717
1970	104,405	19,950	0	0	964,915	8,645	17,290	228,095	1,343,300
1971	129,596	21,720	0	0	1,377,772	9,412	20,272	264,260	1,823,032
1972	160,756	24,113	0	0	2,175,835	11,253	43,131	905,057	3,320,145
1973	195,541	26,664	0	386,638	2,373,167	13,333	27,553	373,307	3,396,203
1974	224,202	27,909	0	446,545	2,781,595	13,954	29,770	445,138	3,969,113
1975	329,688	27,413	0	481,560	3,041,048	14,620	33,702	427,591	4,755,622
1976	414,245	29,388	0	549,549	3,931,785	15,673	35,966	877,151	5,853,757
1977	312,532	28,195	0	569,545	4,071,218	15,977	40,289	626,210	5,663,966
1978	342,208	31,588	0	674,939	4,950,959	20,006	41,065	666,516	6,727,281
1979	395,523	34,294	0	772,757	5,901,986	22,863	45,725	771,613	7,944,761
1980	555,341	37,679	0	881,371	6,984,026	27,272	70,658	933,481	9,489,828
1981	740,789	54,204	0	1,351,487	11,140,730	41,556	77,692	1,373,168	14,779,626
1982	782,396	57,248	0	1,518,993	12,703,436	47,707	85,873	1,530,443	16,726,096
1983	543,462	38,004	0	1,057,789	9,141,315	35,471	58,273	78,506	10,952,820
1984	580,379	13,572	0	1,333,200	9,741,623	39,893	61,770	756,132	12,526,569
1985	667,740	42,441	0	1,540,611	11,403,920	48,100	69,320	644,383	14,416,515
1986	745,447	45,362	0	1,714,679	12,925,113	55,946	77,115	1,469,725	17,033,387
1987	762,180	44,485	0	1,766,065	13,410,817	59,314	77,108	1,503,601	17,623,570
1988	827,669	46,411	0	1,916,790	14,707,763	61,882	83,540	1,633,680	19,277,735
1989	921,621	49,728	0	2,125,033	16,312,361	66,304	92,825	1,821,693	21,369,565
1990	964,288	50,136	0	1,998,766	17,276,959	66,848	95,259	1,980,383	22,432,639
1991	1,023,374	53,208	0	2,121,239	18,335,590	70,944	101,096	2,101,729	23,807,180
1992	1,169,299	60,795	0	2,727,688	20,646,125	81,061	115,511	2,401,419	27,201,898
1993	1,172,060	60,939	0	2,734,129	20,694,874	81,252	115,784	2,407,089	27,266,127
1994	1,123,198	58,398	0	2,156,809	20,295,455	77,865	110,957	2,306,739	26,129,421
1995	1,202,009	62,497	0	2,803,995	21,223,694	83,328	118,743	2,468,598	27,962,864
1996	534,818	69,191	0	2,756,635	19,492,814	81,921	102,219	2,426,904	25,464,502
1997	1,208,521	67,162	0	3,047,908	22,148,973	90,576	129,072	2,683,338	29,375,550
1998	1,216,671	77,807	0	2,726,511	22,070,376	91,188	129,942	2,820,148	29,132,643
1999	1,258,233	69,974	0	2,819,648	22,824,299	94,303	134,381	2,793,715	29,994,553
2000	1,278,056	70,943	0	3,223,279	21,220,235	95,788	136,498	2,837,730	28,862,529
2001	1,278,336	71,058	0	2,864,700	21,110,372	95,809	136,528	2,838,352	28,395,155
2002	1,393,975	72,121	0	3,272,056	21,060,431	97,237	138,564	2,711,156	28,745,540
2003	1,364,640	70,550	0	3,203,191	20,617,243	95,192	135,648	2,654,103	28,140,567
2004	1,351,659	70,317	0	3,508,929	20,084,922	94,286	134,357	2,619,428	27,863,898
2005	1,403,895	73,157	0	3,474,639	20,976,687	220,342	139,550	2,598,245	28,886,515
2006	1,422,433	74,130	0	3,338,845	21,435,340	223,252	141,392	2,386,977	29,022,369
2007	1,563,559	81,479	0	3,670,110	23,562,051	253,717	155,421	2,615,486	31,901,823
2008	1,599,401	83,191	0	3,754,239	24,102,160	259,533	158,983	2,675,439	32,632,946
2009	2,005,490	104,350	0	4,707,444	30,221,718	325,429	199,349	3,354,736	40,917,702
2010	2,005,490	103,536	0	4,707,444	30,221,718	325,429	199,349	3,354,736	40,917,702
2011	2,005,490	103,536	0	4,707,444	30,221,718	325,429	199,349	3,354,736	40,917,702
2012	2,005,490	103,536	0	4,707,444	30,221,718	325,429	199,349	3,354,736	40,917,702
2013	2,005,490	103,536	0	4,707,444	30,221,718	325,429	199,349	3,354,736	40,917,702
2014	2,005,490	103,536	0	4,707,444	30,221,718	325,429	199,349	3,354,736	40,917,702
2015	2,005,490	103,536	0	4,707,444	30,221,718	325,429	199,349	3,354,736	40,917,702
2016	2,005,490	103,536	0	4,707,444	30,221,718	325,429	199,349	3,354,736	40,917,702
2017	2,005,490	103,536	0	4,707,444	30,221,718	325,429	199,349	3,354,736	40,917,702
2018	2,005,490	103,536	0	4,707,444	30,221,718	325,429	199,349	3,354,736	40,917,702
2019	2,005,490	103,536	0	4,707,444	30,221,718	325,429	199,349	3,354,736	40,917,702
2020	2,005,490	103,536	0	4,707,444	30,221,718	325,429	199,349	3,354,736	40,917,702
2021	2,005,490	103,536	0	4,707,444	30,221,718	325,429	199,349	3,354,736	40,917,702
2022	2,005,490	103,536	0	4,707,444	30,221,718	325,429	199,349	3,354,736	40,917,702
2023	2,005,490	103,536	0	4,707,444	30,221,718	325,429	199,349	3,354,736	40,917,702
2024	2,005,490	103,536	0	4,707,444	30,221,718	325,429	199,349	3,354,736	40,917,702
2025	2,005,490	103,536	0	4,707,444	30,221,718	325,429	199,349	3,354,736	40,917,702
2026	2,005,490	103,536	0	4,707,444	30,221,718	325,429	199,349	3,354,736	40,917,702
2027	2,005,490	103,536	0	4,707,444	30,221,718	325,429	199,349	3,354,736	40,917,702
2028	2,005,490	103,536	0	4,707,444	30,221,718	325,429	199,349	3,354,736	40,917,702
2029	2,005,490	103,536	0	4,707,444	30,221,718	325,429	199,349	3,354,736	40,917,702
2030	2,005,490	103,536	0	4,707,444	30,221,718	325,429	199,349	3,354,736	40,917,702
2031	2,005,490	103,536	0	4,707,444	30,221,718	325,429	199,349	3,354,736	40,917,702
2032	2,005,490	103,536	0	4,707,444	30,221,718	325,429	199,349	3,354,736	40,917,702
2033	2,005,490	103,536	0	4,707,444	30,221,718	325,429	199,349	3,354,736	40,917,702
2034	2,005,490	103,536	0	4,707,444	30,221,718	325,429	199,349	3,354,736	40,917,702
2035	2,005,490	103,536	0	4,707,444	30,221,718	325,429	199,349	3,354,736	40,917,702
TOTAL	87,514,337	4,807,457	0	202,391,855	1,365,709,578	11,677,583	8,918,143	156,835,686	1,837,854,639

**TABLE B-21. Total Delta Water Charge for Each Contractor**

(in dollars)

Sheet 3 of 4

Calendar Year	SOUTHERN CALIFORNIA AREA									
	Antelope Valley-East Kern Water Agency	Castaic Lake Water Agency	Coachella Valley Water District	Crestline-Lake Arrowhead Water Agency	Desert Water Agency	Littlerock Creek Irrigation District	Mojave Water Agency	Palmdale Water District	San Bernardino Valley Municipal Water District	San Gabriel Valley Municipal Water District
	[20]	[21]	[22]	[23]	[24]	[25]	[26]	[27]	[28]	[29]
1964	0	0	0	0	0	0	0	0	0	0
1965	0	0	0	0	0	0	0	0	0	0
1966	0	0	0	0	0	0	0	0	0	0
1967	0	0	0	0	0	0	0	0	0	0
1968	0	13,060	0	0	0	0	0	0	0	0
1969	0	17,804	0	0	0	0	0	0	0	0
1970	0	37,905	0	0	0	0	0	0	0	0
1971	0	48,508	0	0	0	0	0	0	0	0
1972	160,756	74,751	41,797	4,662	64,303	1,367	67,518	13,021	369,739	85,202
1973	222,207	107,163	51,552	7,279	79,994	2,577	95,104	26,131	54,908	14,338
1974	279,090	143,266	59,539	10,791	93,030	3,721	121,869	39,631	465,150	114,427
1975	319,822	166,307	63,964	13,250	100,515	4,752	140,722	50,989	479,733	119,705
1976	431,018	207,673	74,449	17,045	117,550	6,269	174,366	67,591	538,772	137,142
1977	469,922	226,502	79,144	19,079	122,180	6,861	189,848	77,255	540,410	139,097
1978	600,180	274,819	97,313	24,428	147,413	9,687	236,913	98,345	631,768	165,313
1979	720,173	320,077	115,033	29,836	171,470	11,889	284,640	117,285	714,457	189,700
1980	857,818	376,845	134,920	35,949	210,736	14,256	337,177	138,590	811,952	215,694
1981	1,355,100	592,631	218,713	57,637	343,292	22,946	534,813	211,396	1,237,658	330,644
1982	1,551,434	664,082	254,298	66,408	400,739	26,335	313,057	235,100	1,341,923	364,482
1983	1,110,994	472,521	184,283	47,759	291,367	19,002	434,517	163,925	943,775	252,096
1984	450,405	509,602	202,914	52,247	321,718	20,719	472,282	174,500	1,003,760	266,383
1985	565,881	591,346	240,344	61,540	381,970	24,474	551,734	200,605	1,152,983	308,405
1986	635,066	659,259	275,347	70,160	438,498	27,822	625,994	223,785	1,285,253	350,799
1987	652,450	676,176	288,131	73,104	467,095	29,064	648,002	228,654	1,319,729	364,779
1988	711,641	742,582	319,496	80,756	525,996	32,024	711,641	248,146	1,438,752	402,232
1989	2,083,593	830,453	362,565	91,333	605,021	36,301	803,932	276,155	1,607,864	454,180
1990	2,207,667	869,029	386,049	96,930	636,731	38,438	848,974	289,119	1,696,277	481,308
1991	2,454,678	961,298	409,704	102,869	675,746	40,793	900,994	306,835	1,819,725	510,800
1992	2,804,695	1,098,371	468,125	117,538	772,102	46,610	1,029,469	350,587	2,079,203	583,636
1993	2,811,318	1,100,964	469,230	117,815	773,925	46,720	1,031,900	351,415	2,084,113	585,014
1994	2,694,116	1,055,065	449,668	112,905	741,661	44,772	988,880	336,766	1,997,227	560,625
1995	2,883,156	1,129,097	481,220	120,826	793,702	47,914	1,058,269	360,394	2,137,369	599,963
1996	2,834,460	1,110,027	473,093	118,785	780,296	47,104	1,040,394	354,307	2,101,269	589,830
1997	3,133,957	1,227,316	523,081	131,336	862,744	52,082	1,150,325	391,745	2,323,295	652,153
1998	3,155,093	1,235,593	526,609	132,222	868,562	52,433	1,126,006	394,387	2,338,963	656,551
1999	3,262,870	1,277,800	544,598	136,739	898,233	54,224	1,187,034	407,859	2,418,863	678,979
2000	3,314,278	2,279,763	553,178	138,893	912,384	55,078	1,815,190	510,073	2,456,972	689,676
2001	3,315,004	2,280,263	553,299	138,924	912,584	55,090	1,815,587	510,185	2,457,510	689,827
2002	3,437,351	2,314,256	561,548	140,995	926,188	55,912	1,842,654	517,791	2,494,146	700,112
2003	3,365,016	2,265,555	549,731	138,028	906,698	54,735	1,803,877	506,894	2,441,659	685,379
2004	3,333,008	2,244,004	544,501	136,715	898,074	54,215	1,786,717	502,073	2,418,434	678,859
2005	3,461,814	2,330,727	565,544	141,999	932,780	56,310	1,917,073	521,475	2,511,896	705,093
2006	3,507,524	2,361,502	3,003,969	143,873	1,240,285	57,053	1,880,272	528,361	2,545,064	714,404
2007	3,855,524	2,595,798	3,302,008	158,148	1,363,339	62,714	2,066,822	580,783	2,797,573	785,284
2008	3,943,904	2,655,301	3,377,700	161,773	1,394,591	64,151	2,114,200	594,096	2,861,701	803,284
2009	4,945,264	3,329,485	4,235,300	202,847	1,748,679	80,439	2,650,997	744,937	3,588,289	1,007,239
2010	4,945,264	3,329,485	4,235,300	202,847	1,748,679	80,439	2,650,997	744,937	3,588,289	1,007,239
2011	4,945,264	3,329,485	4,235,300	202,847	1,748,679	80,439	2,650,997	744,937	3,588,289	1,007,239
2012	4,945,264	3,329,485	4,235,300	202,847	1,748,679	80,439	2,650,997	744,937	3,588,289	1,007,239
2013	4,945,264	3,329,485	4,235,300	202,847	1,748,679	80,439	2,650,997	744,937	3,588,289	1,007,239
2014	4,945,264	3,329,485	4,235,300	202,847	1,748,679	80,439	2,650,997	744,937	3,588,289	1,007,239
2015	4,945,264	3,329,485	4,235,300	202,847	1,748,679	80,439	2,650,997	744,937	3,588,289	1,007,239
2016	4,945,264	3,329,485	4,235,300	202,847	1,748,679	80,439	2,650,997	744,937	3,588,289	1,007,239
2017	4,945,264	3,329,485	4,235,300	202,847	1,748,679	80,439	2,650,997	744,937	3,588,289	1,007,239
2018	4,945,264	3,329,485	4,235,300	202,847	1,748,679	80,439	2,650,997	744,937	3,588,289	1,007,239
2019	4,945,264	3,329,485	4,235,300	202,847	1,748,679	80,439	2,650,997	744,937	3,588,289	1,007,239
2020	4,945,264	3,329,485	4,235,300	202,847	1,748,679	80,439	2,650,997	744,937	3,588,289	1,007,239
2021	4,945,264	3,329,485	4,235,300	202,847	1,748,679	80,439	2,650,997	744,937	3,588,289	1,007,239
2022	4,945,264	3,329,485	4,235,300	202,847	1,748,679	80,439	2,650,997	744,937	3,588,289	1,007,239
2023	4,945,264	3,329,485	4,235,300	202,847	1,748,679	80,439	2,650,997	744,937	3,588,289	1,007,239
2024	4,945,264	3,329,485	4,235,300	202,847	1,748,679	80,439	2,650,997	744,937	3,588,289	1,007,239
2025	4,945,264	3,329,485	4,235,300	202,847	1,748,679	80,439	2,650,997	744,937	3,588,289	1,007,239
2026	4,945,264	3,329,485	4,235,300	202,847	1,748,679	80,439	2,650,997	744,937	3,588,289	1,007,239
2027	4,945,264	3,329,485	4,235,300	202,847	1,748,679	80,439	2,650,997	744,937	3,588,289	1,007,239
2028	4,945,264	3,329,485	4,235,300	202,847	1,748,679	80,439	2,650,997	744,937	3,588,289	1,007,239
2029	4,945,264	3,329,485	4,235,300	202,847	1,748,679	80,439	2,650,997	744,937	3,588,289	1,007,239
2030	4,945,264	3,329,485	4,235,300	202,847	1,748,679	80,439	2,650,997	744,937	3,588,289	1,007,239
2031	4,945,264	3,329,485	4,235,300	202,847	1,748,679	80,439	2,650,997	744,937	3,588,289	1,007,239
2032	4,945,264	3,329,485	4,235,300	202,847	1,748,679	80,439	2,650,997	744,937	3,588,289	1,007,239
2033	4,945,264	3,329,485	4,235,300	202,847	1,748,679	80,439	2,650,997	744,937	3,588,289	1,007,239
2034	4,945,264	3,329,485	4,235,300	202,847	1,748,679	80,439	2,650,997	744,937	3,588,289	1,007,239
2035	4,945,264	3,329,485	4,235,300	202,847	1,748,679	80,439	2,650,997	744,937	3,588,289	1,007,239
TOTAL	206,475,111	130,041,156	135,159,757	8,727,445	69,387,845	3,458,267	106,927,685	31,019,548	156,803,648	43,820,908

**TABLE B-21. Total Delta Water Charge for Each Contractor**

(in dollars)

Sheet 4 of 4

Calendar Year	SOUTHERN CALIFORNIA AREA (continued)				FEATHER RIVER AREA				South Bay Area Future Contractor	GRAND TOTAL
	San Gorgonio Pass Water Agency	The Metropolitan Water District of Southern California	Ventura County Watershed Protection District	Total	City of Yuba City	County of Butte	Plumas County FC&WCD	Total		
	[30]	[31]	[32]	[33]	[34]	[35]	[36]	[37]	[38]	[39]
1964	0	0	0	0	0	0	0	0	0	0
1965	0	0	0	0	0	0	0	0	0	0
1966	0	0	0	0	0	0	0	0	0	0
1967	0	0	0	0	0	0	0	0	0	241,150
1968	0	0	0	13,060	0	1,050	875	1,925	0	583,631
1969	0	0	0	17,804	0	1,225	929	2,154	0	827,578
1970	0	0	0	37,905	0	3,848	1,995	5,843	0	2,160,886
1971	0	0	0	48,508	0	4,546	3,186	7,732	0	2,696,792
1972	0	2,043,211	0	2,926,327	0	4,929	3,778	8,707	0	7,206,052
1973	0	2,317,893	0	2,979,146	0	7,059	4,444	11,503	0	7,456,998
1974	0	4,231,933	0	5,562,447	0	8,336	4,931	13,267	0	10,683,514
1975	0	5,073,286	0	6,533,045	0	9,416	5,117	14,533	0	12,440,851
1976	0	6,422,167	0	8,194,042	0	7,004	5,780	12,784	0	15,299,760
1977	0	7,104,278	0	8,974,576	0	16,917	5,827	22,744	0	15,869,924
1978	0	9,016,389	0	11,302,568	0	12,635	6,844	19,479	0	19,425,531
1979	0	10,935,192	0	13,609,812	0	16,575	7,773	24,348	0	23,095,855
1980	84,294	13,102,796	12,396	16,333,423	0	19,834	8,801	28,635	0	27,557,096
1981	140,930	20,910,099	36,136	25,991,995	0	21,682	13,370	35,052	0	43,335,911
1982	167,929	23,998,560	57,248	29,441,595	0	16,117	14,694	30,811	0	49,027,703
1983	124,148	17,203,307	50,672	21,298,366	0	15,202	10,134	25,336	0	34,186,736
1984	138,982	18,766,458	64,344	22,444,314	20,590	15,442	10,681	46,713	0	37,051,405
1985	166,935	22,050,974	84,882	26,382,073	24,050	16,976	12,166	53,192	0	43,235,458
1986	195,056	25,089,658	120,965	29,997,662	31,753	18,145	13,457	63,355	0	49,817,447
1987	207,598	26,095,043	148,284	31,198,109	37,071	17,794	13,642	68,507	0	51,663,899
1988	233,604	28,781,238	201,116	34,429,224	46,722	18,565	14,852	80,139	0	57,062,086
1989	268,530	32,505,376	265,215	40,190,518	61,184	19,891	16,576	97,651	0	65,617,116
1990	289,119	33,616,369	334,242	41,790,252	63,506	20,055	17,381	100,942	0	68,658,631
1991	306,835	35,676,185	354,722	44,521,184	170,267	21,283	19,155	210,705	0	73,265,317
1992	350,587	40,763,329	405,303	50,869,555	194,545	24,318	22,697	241,560	0	83,873,685
1993	351,415	40,859,579	406,260	50,989,668	195,005	24,376	23,563	242,944	0	84,237,281
1994	336,766	39,156,173	389,323	48,863,947	186,875	23,360	23,360	233,595	0	80,866,329
1995	360,394	41,903,674	416,641	52,292,619	199,987	24,999	26,040	251,026	0	86,725,209
1996	0	41,195,923	409,604	51,055,092	196,610	24,576	26,624	247,810	0	83,007,946
1997	0	45,548,610	447,746	56,444,590	214,918	27,173	30,223	272,314	0	93,062,361
1998	0	45,855,992	450,529	57,394,940	107,459	27,356	31,537	166,352	0	93,159,618
1999	47,152	47,422,430	466,491	59,403,272	226,327	28,291	33,820	288,436	0	96,994,387
2000	71,841	48,169,576	478,942	61,445,844	229,892	69,207	35,708	334,807	0	98,699,723
2001	95,809	48,180,135	479,047	61,483,264	229,942	83,833	37,187	350,962	0	98,781,493
2002	97,237	48,898,394	486,188	62,472,772	233,371	85,083	39,185	357,639	0	100,275,854
2003	118,989	47,869,376	475,957	61,181,894	228,460	83,293	39,743	351,496	0	98,210,650
2004	141,429	47,414,032	471,429	60,623,490	226,287	83,306	0	309,593	0	97,492,148
2005	159,136	49,246,383	489,648	63,039,878	235,031	29,701	0	264,732	0	101,068,108
2006	173,640	47,416,073	496,113	64,068,133	238,135	30,107	49,810	318,052	0	102,412,051
2007	204,501	52,120,469	545,336	70,438,299	268,738	33,950	19,600	322,288	0	112,569,420
2008	334,702	53,315,217	557,836	72,178,456	274,736	794,785	56,138	1,125,659	0	116,081,624
2009	605,043	66,851,995	699,472	90,689,986	335,746	968,363	72,825	1,376,934	0	145,718,825
2010	605,043	66,851,995	699,472	90,689,986	335,746	961,773	74,546	1,372,065	0	145,726,258
2011	605,043	66,851,995	699,472	90,689,986	335,746	961,773	77,307	1,374,826	0	145,742,133
2012	605,043	66,851,995	699,472	90,689,986	335,746	961,773	80,068	1,377,587	0	145,758,010
2013	605,043	66,851,995	699,472	90,689,986	335,746	961,773	83,174	1,380,693	0	145,772,482
2014	605,043	66,851,995	699,472	90,689,986	335,746	961,773	86,280	1,383,799	0	145,790,452
2015	605,043	66,851,995	699,472	90,689,986	335,746	961,773	89,731	1,387,250	0	145,819,259
2016	605,043	66,851,995	699,472	90,689,986	335,746	961,773	93,183	1,390,702	0	145,844,569
2017	605,043	66,851,995	699,472	90,689,986	335,746	961,773	93,183	1,390,702	0	145,866,428
2018	605,043	66,851,995	699,472	90,689,986	335,746	961,773	93,183	1,390,702	0	145,888,286
2019	605,043	66,851,995	699,472	90,689,986	335,746	961,773	93,183	1,390,702	0	145,910,145
2020	605,043	66,851,995	699,472	90,689,986	335,746	961,773	93,183	1,390,702	0	145,931,129
2021	605,043	66,851,995	699,472	90,689,986	335,746	961,773	93,183	1,390,702	0	145,934,626
2022	605,043	66,851,995	699,472	90,689,986	335,746	961,773	93,183	1,390,702	0	145,934,626
2023	605,043	66,851,995	699,472	90,689,986	335,746	961,773	93,183	1,390,702	0	145,934,626
2024	605,043	66,851,995	699,472	90,689,986	335,746	961,773	93,183	1,390,702	0	145,934,626
2025	605,043	66,851,995	699,472	90,689,986	335,746	961,773	93,183	1,390,702	0	145,934,626
2026	605,043	66,851,995	699,472	90,689,986	335,746	961,773	93,183	1,390,702	0	145,934,626
2027	605,043	66,851,995	699,472	90,689,986	335,746	961,773	93,183	1,390,702	0	145,934,626
2028	605,043	66,851,995	699,472	90,689,986	335,746	961,773	93,183	1,390,702	0	145,934,626
2029	605,043	66,851,995	699,472	90,689,986	335,746	961,773	93,183	1,390,702	0	145,934,626
2030	605,043	66,851,995	699,472	90,689,986	335,746	961,773	93,183	1,390,702	0	145,934,626
2031	605,043	66,851,995	699,472	90,689,986	335,746	961,773	93,183	1,390,702	0	145,934,626
2032	605,043	66,851,995	699,472	90,689,986	335,746	961,773	93,183	1,390,702	0	145,934,626
2033	605,043	66,851,995	699,472	90,689,986	335,746	961,773	93,183	1,390,702	0	145,934,626
2034	605,043	66,851,995	699,472	90,689,986	335,746	961,773	93,183	1,390,702	0	145,934,626
2035	605,043	66,851,995	699,472	90,689,986	335,746	961,773	93,183	1,390,702	0	145,934,626
TOTAL	21,503,719	2,935,279,842	28,488,359	3,877,093,290	13,206,603	27,786,701	3,139,214	44,132,518	0	6,284,772,580

**TABLE B-22. Water System Revenue Bond Surcharge for Each Contractor**

(in dollars)

Sheet 1 of 4

Calendar Year	NORTH BAY AREA			SOUTH BAY AREA				CENTRAL COASTAL AREA		
	Napa County FC&WCD	Solano County WA	Total	Alameda County FC&WCD, Zone 7	Alameda County Water District	Santa Clara Valley Water District	Total	San Luis Obispo County	Santa Barbara County	Total
	[1]	[2]	[3]	[4]	[5]	[6]	[7]	[8]	[9]	[10]
1971	0	0	0	0	0	0	0	0	0	0
1972	0	0	0	0	0	0	0	0	0	0
1973	0	0	0	0	0	0	0	0	0	0
1974	0	0	0	0	0	0	0	0	0	0
1975	0	0	0	0	0	0	0	0	0	0
1976	0	0	0	0	0	0	0	0	0	0
1977	0	0	0	0	0	0	0	0	0	0
1978	0	0	0	0	0	0	0	0	0	0
1979	0	0	0	0	0	0	0	0	0	0
1980	0	0	0	0	0	0	0	0	0	0
1981	0	0	0	0	0	0	0	0	0	0
1982	0	0	0	0	0	0	0	0	0	0
1983	0	0	0	0	0	0	0	0	0	0
1984	0	0	0	0	0	0	0	0	0	0
1985	0	0	0	0	0	0	0	0	0	0
1986	0	0	0	0	0	0	0	0	0	0
1987	0	0	0	0	0	0	0	0	0	0
1988	29,131	40,505	69,636	25,436	30,176	100,035	155,647	13,126	24,392	37,518
1989	48,804	69,621	118,425	43,343	51,681	170,303	265,327	26,828	49,634	76,462
1990	41,166	60,482	101,648	38,407	51,185	149,440	239,032	27,956	51,795	79,751
1991	63,389	92,401	155,790	62,470	81,991	235,712	380,173	44,887	83,709	128,596
1992	84,320	126,227	210,547	89,247	115,208	325,629	530,084	61,137	113,925	175,062
1993	90,152	137,473	227,625	98,432	125,174	347,457	571,063	67,725	126,662	194,387
1994	91,785	141,222	233,007	102,021	126,216	352,415	580,652	81,420	159,156	240,576
1995	108,311	181,787	290,098	126,000	149,378	416,955	692,333	131,674	270,727	402,401
1996	132,304	232,343	364,647	158,514	180,787	505,043	844,344	242,654	534,448	777,102
1997	135,556	237,492	373,048	171,263	187,162	522,127	880,552	141,810	846,616	988,426
1998	130,346	228,366	358,712	164,682	179,971	502,065	846,718	136,361	814,087	950,448
1999	182,507	316,416	498,923	227,072	248,031	691,830	1,166,933	188,835	1,124,110	1,312,945
2000	238,571	364,418	602,989	260,766	284,875	794,730	1,340,371	218,359	1,364,019	1,582,378
2001	234,773	358,616	593,389	561,965	280,341	782,078	1,624,384	214,883	1,342,304	1,557,187
2002	257,520	391,851	649,371	610,230	288,977	806,174	1,705,381	221,503	1,383,661	1,605,164
2003	268,151	408,027	676,178	635,422	300,907	839,455	1,775,784	230,647	1,440,782	1,671,429
2004	268,425	408,444	676,869	636,070	301,214	840,312	1,777,596	230,883	1,442,252	1,673,135
2005	253,413	385,602	639,015	610,756	284,369	793,318	1,688,443	217,970	1,361,594	1,579,564
2006	274,219	417,261	691,480	660,900	307,716	858,451	1,827,067	235,866	1,473,385	1,709,251
2007	261,107	397,309	658,416	629,298	293,003	817,402	1,739,703	224,589	1,402,932	1,627,521
2008	425,866	648,010	1,073,876	1,026,385	477,887	1,333,184	2,837,456	366,303	2,288,183	2,654,486
2009	492,265	749,046	1,241,311	1,186,417	552,398	1,541,052	3,279,867	423,416	2,644,951	3,068,367
2010	473,014	719,753	1,192,767	1,140,019	530,795	1,480,784	3,151,598	406,858	2,541,514	2,948,372
2011	505,729	769,533	1,275,262	1,218,866	567,506	1,583,199	3,369,571	434,997	2,717,292	3,152,289
2012	506,244	770,316	1,276,560	1,220,106	568,084	1,584,810	3,373,000	435,439	2,720,056	3,155,495
2013	531,126	808,178	1,339,304	1,280,076	596,006	1,662,706	3,538,788	456,842	2,853,751	3,310,593
2014	549,067	835,478	1,384,545	1,323,315	616,138	1,718,870	3,658,323	472,274	2,950,147	3,422,421
2015	575,109	875,103	1,450,212	1,386,079	645,361	1,800,394	3,831,834	494,673	3,090,069	3,584,742
2016	580,457	883,241	1,463,698	1,398,968	651,362	1,817,136	3,867,466	499,273	3,118,804	3,618,077
2017	572,611	871,303	1,443,914	1,380,058	642,558	1,792,574	3,815,190	492,524	3,076,648	3,569,172
2018	510,350	776,564	1,286,914	1,230,002	572,691	1,597,664	3,400,357	438,971	2,742,118	3,181,089
2019	546,783	832,002	1,378,785	1,317,810	613,575	1,711,720	3,643,105	470,309	2,937,874	3,408,183
2020	507,100	771,620	1,278,720	1,222,171	569,045	1,587,492	3,378,708	436,176	2,724,659	3,160,835
2021	512,108	779,240	1,291,348	1,234,240	574,665	1,603,169	3,412,074	440,484	2,751,567	3,192,051
2022	496,316	755,210	1,251,526	1,196,179	556,943	1,553,732	3,306,854	426,900	2,666,715	3,093,615
2023	495,956	754,662	1,250,618	1,195,311	556,539	1,552,603	3,304,453	426,590	2,664,779	3,091,369
2024	478,163	727,588	1,205,751	1,152,428	536,573	1,496,903	3,185,904	411,286	2,569,178	2,980,464
2025	435,528	662,712	1,098,240	1,049,672	488,729	1,363,431	2,901,832	374,614	2,340,097	2,714,711
2026	396,111	602,735	998,846	954,674	444,498	1,240,038	2,639,210	340,710	2,128,313	2,469,023
2027	434,905	661,765	1,096,670	1,048,171	488,030	1,361,481	2,897,682	374,078	2,336,750	2,710,828
2028	333,680	507,738	841,418	804,208	374,441	1,044,595	2,223,244	287,011	1,792,869	2,079,880
2029	363,402	552,963	916,365	875,840	407,793	1,137,639	2,421,272	312,576	1,952,564	2,265,140
2030	0	0	0	0	0	0	0	0	0	0
2031	0	0	0	0	0	0	0	0	0	0
2032	0	0	0	0	0	0	0	0	0	0
2033	0	0	0	0	0	0	0	0	0	0
2034	0	0	0	0	0	0	0	0	0	0
2035	0	0	0	0	0	0	0	0	0	0
<b>TOTAL</b>	<b>13,915,840</b>	<b>21,310,623</b>	<b>35,226,463</b>	<b>31,753,289</b>	<b>15,899,979</b>	<b>44,416,107</b>	<b>92,069,375</b>	<b>12,181,417</b>	<b>73,019,088</b>	<b>85,200,505</b>



**TABLE B-22. Water System Revenue Bond Surcharge for Each Contractor**

(in dollars)

Sheet 2 of 4

Calendar Year	SAN JOAQUIN VALLEY AREA								
	Dudley Ridge Water District	Empire West Side Irrigation District	Future Contractor San Joaquin Valley	Kern County Water Agency		County of Kings	Oak Flat Water District	Tulare Lake Basin Water Storage District	Total
				Municipal and Industrial	Agri-cultural				
	[11]	[12]	[13]	[14]	[15]	[16]	[17]	[18]	[19]
1971	0	0	0	0	0	0	0	0	0
1972	0	0	0	0	0	0	0	0	0
1973	0	0	0	0	0	0	0	0	0
1974	0	0	0	0	0	0	0	0	0
1975	0	0	0	0	0	0	0	0	0
1976	0	0	0	0	0	0	0	0	0
1977	0	0	0	0	0	0	0	0	0
1978	0	0	0	0	0	0	0	0	0
1979	0	0	0	0	0	0	0	0	0
1980	0	0	0	0	0	0	0	0	0
1981	0	0	0	0	0	0	0	0	0
1982	0	0	0	0	0	0	0	0	0
1983	0	0	0	0	0	0	0	0	0
1984	0	0	0	0	0	0	0	0	0
1985	0	0	0	0	0	0	0	0	0
1986	0	0	0	0	0	0	0	0	0
1987	0	0	0	0	0	0	0	0	0
1988	33,986	1,657	0	67,288	726,501	2,228	2,851	66,748	901,259
1989	59,273	2,785	0	116,689	1,251,452	3,733	4,927	116,736	1,555,595
1990	53,349	2,419	0	287,811	947,351	3,248	4,367	109,118	1,407,663
1991	82,252	3,731	0	359,380	1,564,983	5,035	6,771	168,217	2,190,369
1992	112,566	5,127	0	452,691	2,153,423	6,927	9,285	230,217	2,970,236
1993	119,670	5,459	0	272,449	2,491,672	7,381	9,894	244,813	3,151,338
1994	118,265	5,379	0	244,671	2,485,820	7,300	9,766	241,933	3,113,134
1995	139,227	6,339	0	317,885	2,894,182	8,598	11,490	284,798	3,662,519
1996	169,333	7,703	0	354,341	2,722,241	10,460	13,978	346,366	3,624,422
1997	165,364	7,980	0	366,285	2,673,847	10,826	14,465	357,986	3,596,753
1998	159,011	7,672	0	352,211	2,571,110	10,410	13,909	344,232	3,458,555
1999	218,784	10,373	0	485,897	3,371,115	14,376	19,166	476,017	4,595,728
2000	251,339	11,735	0	557,296	3,620,348	16,500	21,990	546,406	5,025,614
2001	247,338	11,547	0	548,424	3,461,158	16,238	21,640	537,707	4,844,052
2002	273,542	11,904	0	565,321	3,496,023	16,737	22,306	521,659	4,907,492
2003	284,834	12,395	0	588,659	3,640,346	17,428	23,227	543,193	5,110,082
2004	285,125	12,408	0	589,259	3,644,059	17,446	23,251	543,748	5,115,296
2005	269,179	11,714	0	556,305	3,431,851	39,485	21,951	488,483	4,818,968
2006	291,279	12,676	0	601,979	3,713,614	42,726	23,753	528,589	5,214,616
2007	277,351	12,070	0	573,194	3,536,041	42,130	22,617	454,916	4,918,319
2008	452,361	19,685	0	934,881	5,767,286	68,714	36,888	741,968	8,021,783
2009	522,891	22,755	0	1,080,645	6,666,506	79,427	42,640	857,653	9,272,517
2010	502,443	21,865	0	1,038,384	6,405,798	76,321	40,972	824,113	8,909,896
2011	537,193	23,377	0	1,110,201	6,848,840	81,600	43,806	881,111	9,526,128
2012	537,739	23,401	0	1,111,331	6,855,807	81,683	43,851	882,007	9,535,819
2013	564,170	24,551	0	1,165,954	7,192,781	85,698	46,006	925,359	10,004,519
2014	583,227	25,380	0	1,205,339	7,435,745	88,592	47,560	956,617	10,342,460
2015	610,889	26,584	0	1,262,506	7,788,412	92,794	49,816	1,001,988	10,832,989
2016	616,569	26,831	0	1,274,246	7,860,837	93,657	50,279	1,011,305	10,933,724
2017	608,236	26,469	0	1,257,023	7,754,585	92,391	49,599	997,636	10,785,939
2018	542,101	23,591	0	1,120,344	6,911,414	82,345	44,206	889,161	9,613,162
2019	580,801	25,275	0	1,200,324	7,404,811	88,224	47,362	952,637	10,299,434
2020	538,649	23,440	0	1,113,211	6,867,409	81,821	43,925	883,500	9,551,955
2021	543,969	23,672	0	1,124,205	6,935,229	82,629	44,359	892,225	9,646,288
2022	527,194	22,942	0	1,089,537	6,721,363	80,081	42,991	864,711	9,348,819
2023	526,811	22,925	0	1,088,746	6,716,482	80,023	42,959	864,083	9,342,029
2024	507,912	22,103	0	1,049,686	6,475,524	77,152	41,418	833,083	9,006,878
2025	462,624	20,132	0	956,091	5,898,134	70,273	37,725	758,802	8,203,781
2026	420,755	18,310	0	869,563	5,364,340	63,913	34,311	690,128	7,461,320
2027	461,962	20,103	0	954,724	5,889,698	70,172	37,671	757,716	8,192,046
2028	354,440	15,424	0	732,511	4,518,865	53,840	28,903	581,357	6,285,340
2029	386,011	16,798	0	797,757	4,921,370	58,635	31,478	633,140	6,845,189
2030	0	0	0	0	0	0	0	0	0
2031	0	0	0	0	0	0	0	0	0
2032	0	0	0	0	0	0	0	0	0
2033	0	0	0	0	0	0	0	0	0
2034	0	0	0	0	0	0	0	0	0
2035	0	0	0	0	0	0	0	0	0
TOTAL	15,000,014	658,686	0	31,795,244	199,598,373	2,029,197	1,230,329	25,832,182	276,144,025

**TABLE B-22. Water System Revenue Bond Surcharge for Each Contractor**

(in dollars)

Sheet 3 of 4

Calendar Year	SOUTHERN CALIFORNIA AREA									
	Antelope Valley-East Kern Water Agency	Castaic Lake Water Agency	Coachella Valley Water District	Crestline Lake Arrowhead Water Agency	Desert Water Agency	Littlerock Creek Irrigation District	Mojave Water Agency	Palmdale Water District	San Bernardino Valley Municipal Water District	San Gabriel Valley Municipal Water District
	[20]	[21]	[22]	[23]	[24]	[25]	[26]	[27]	[28]	[29]
1971	0	0	0	0	0	0	0	0	0	0
1972	0	0	0	0	0	0	0	0	0	0
1973	0	0	0	0	0	0	0	0	0	0
1974	0	0	0	0	0	0	0	0	0	0
1975	0	0	0	0	0	0	0	0	0	0
1976	0	0	0	0	0	0	0	0	0	0
1977	0	0	0	0	0	0	0	0	0	0
1978	0	0	0	0	0	0	0	0	0	0
1979	0	0	0	0	0	0	0	0	0	0
1980	0	0	0	0	0	0	0	0	0	0
1981	0	0	0	0	0	0	0	0	0	0
1982	0	0	0	0	0	0	0	0	0	0
1983	0	0	0	0	0	0	0	0	0	0
1984	0	0	0	0	0	0	0	0	0	0
1985	0	0	0	0	0	0	0	0	0	0
1986	0	0	0	0	0	0	0	0	0	0
1987	0	0	0	0	0	0	0	0	0	0
1988	64,266	57,111	27,032	7,656	44,492	2,154	55,996	16,240	151,182	39,907
1989	205,668	98,720	46,993	13,263	78,104	3,763	97,138	27,981	259,860	69,104
1990	185,010	87,808	42,449	11,905	69,970	3,385	87,327	24,956	231,650	61,851
1991	296,854	140,371	65,947	18,548	108,704	5,236	135,623	38,641	363,310	96,172
1992	402,015	234,421	89,358	25,192	147,297	7,053	183,813	52,160	491,537	130,372
1993	424,871	247,076	93,981	26,566	154,919	7,437	193,361	55,045	517,379	137,298
1994	424,023	247,222	94,502	26,865	155,776	7,431	194,191	54,968	525,394	139,422
1995	500,083	290,999	111,729	31,823	184,169	8,769	229,530	64,852	623,848	165,594
1996	606,387	353,131	135,428	38,635	223,236	10,640	278,178	78,696	760,333	201,821
1997	626,151	362,776	139,565	39,802	230,058	10,972	286,779	81,146	808,482	207,472
1998	602,091	348,838	134,202	38,273	221,218	10,550	275,761	78,028	777,418	199,501
1999	826,108	479,470	184,524	52,650	304,166	14,475	642,815	107,060	1,041,566	277,200
2000	940,325	1,150,965	210,453	60,212	346,906	16,486	736,157	121,898	1,191,538	316,860
2001	925,355	1,132,642	207,102	59,254	341,384	16,224	724,438	135,581	1,172,568	311,816
2002	974,814	1,167,539	213,483	61,079	351,902	16,724	746,758	139,071	1,208,696	321,423
2003	1,015,056	1,215,738	222,296	63,601	366,429	17,415	777,586	144,812	1,258,593	334,692
2004	1,016,092	1,216,978	222,523	63,666	366,803	17,432	778,379	144,960	1,259,877	335,033
2005	959,268	1,148,920	210,078	60,105	346,290	16,457	734,849	136,853	1,189,420	316,297
2006	1,038,026	1,243,248	213,645	65,040	501,286	17,809	795,182	148,089	1,287,074	342,266
2007	988,391	1,183,800	1,155,613	61,931	477,316	16,957	757,159	141,008	1,225,529	325,900
2008	1,612,066	1,930,779	1,884,805	101,008	778,503	27,657	1,234,926	229,984	1,998,840	531,542
2009	1,863,416	2,231,821	2,178,679	116,757	899,885	31,969	1,427,473	265,842	2,310,494	614,419
2010	1,790,542	2,144,540	2,093,477	112,191	864,693	30,719	1,371,648	255,446	2,220,137	590,391
2011	1,914,381	2,292,862	2,238,267	119,950	924,497	32,843	1,466,515	273,113	2,373,688	631,224
2012	1,916,328	2,295,195	2,240,544	120,072	925,438	32,877	1,468,007	273,391	2,376,102	631,866
2013	2,010,519	2,408,008	2,350,670	125,974	970,925	34,493	1,540,162	286,829	2,492,892	662,923
2014	2,078,432	2,489,347	2,430,073	130,229	1,003,721	35,658	1,592,187	296,518	2,577,098	685,316
2015	2,177,009	2,607,414	2,545,328	136,406	1,051,326	37,349	1,667,702	310,581	2,699,327	717,819
2016	2,197,253	2,631,660	2,568,997	137,674	1,061,103	37,696	1,683,210	313,469	2,724,428	724,494
2017	2,167,554	2,596,089	2,534,273	135,814	1,046,760	37,187	1,660,459	309,232	2,687,603	714,702
2018	1,931,871	2,313,811	2,258,717	121,046	932,944	33,143	1,479,914	275,609	2,395,375	636,991
2019	2,069,785	2,478,991	2,419,964	129,688	999,546	35,509	1,585,563	295,284	2,566,377	682,465
2020	1,919,571	2,299,079	2,244,335	120,276	927,004	32,932	1,470,491	273,854	2,380,123	632,935
2021	1,938,528	2,321,784	2,266,500	121,463	936,159	33,257	1,485,013	276,558	2,403,629	639,186
2022	1,878,748	2,250,186	2,196,606	117,718	907,290	32,232	1,439,219	268,030	2,329,506	619,475
2023	1,877,384	2,248,552	2,195,011	117,632	906,631	32,208	1,438,174	267,835	2,327,815	619,025
2024	1,810,032	2,167,883	2,116,264	113,412	874,105	31,053	1,386,578	258,226	2,244,303	596,817
2025	1,648,640	1,974,584	1,927,567	103,300	796,165	28,284	1,262,944	235,202	2,044,190	543,602
2026	1,499,435	1,795,880	1,753,118	93,951	724,111	25,724	1,148,645	213,915	1,859,186	494,405
2027	1,646,282	1,971,760	1,924,810	103,152	795,027	28,244	1,261,138	234,865	2,041,266	542,824
2028	1,263,109	1,512,831	1,476,809	79,143	609,983	21,670	967,607	180,200	1,566,159	416,481
2029	1,375,616	1,647,582	1,608,351	86,193	664,316	23,600	1,053,793	196,251	1,705,660	453,578
2030	0	0	0	0	0	0	0	0	0	0
2031	0	0	0	0	0	0	0	0	0	0
2032	0	0	0	0	0	0	0	0	0	0
2033	0	0	0	0	0	0	0	0	0	0
2034	0	0	0	0	0	0	0	0	0	0
2035	0	0	0	0	0	0	0	0	0	0
TOTAL	53,607,355	61,018,411	52,274,068	3,369,115	24,620,557	923,673	39,802,388	7,582,279	66,669,452	17,712,481

**TABLE B-22. Water System Revenue Bond Surcharge for Each Contractor**

(in dollars)

Sheet 4 of 4

Calendar Year	SOUTHERN CALIFORNIA AREA (continued)				FEATHER RIVER AREA				South Bay Area Future Contractor	GRAND TOTAL
	San Gorgonio Pass Water Agency	The Metropolitan Water District of Southern California	Ventura County Watershed Protection District	Total	City of Yuba City	County of Butte	Plumas County FC&WCD	Total		
	[30]	[31]	[32]	[33]	[34]	[35]	[36]	[37]	[38]	[39]
1971	0	0	0	0	0	0	0	0	0	0
1972	0	0	0	0	0	0	0	0	0	0
1973	0	0	0	0	0	0	0	0	0	0
1974	0	0	0	0	0	0	0	0	0	0
1975	0	0	0	0	0	0	0	0	0	0
1976	0	0	0	0	0	0	0	0	0	0
1977	0	0	0	0	0	0	0	0	0	0
1978	0	0	0	0	0	0	0	0	0	0
1979	0	0	0	0	0	0	0	0	0	0
1980	0	0	0	0	0	0	0	0	0	0
1981	0	0	0	0	0	0	0	0	0	0
1982	0	0	0	0	0	0	0	0	0	0
1983	0	0	0	0	0	0	0	0	0	0
1984	0	0	0	0	0	0	0	0	0	0
1985	0	0	0	0	0	0	0	0	0	0
1986	0	0	0	0	0	0	0	0	0	0
1987	0	0	0	0	0	0	0	0	0	0
1988	24,019	2,642,354	18,118	3,150,527	1,336	552	853	2,741	0	4,317,328
1989	42,040	4,587,641	34,565	5,564,840	0	918	1,454	2,372	0	7,583,021
1990	38,023	4,037,980	34,994	4,917,308	2,535	800	1,283	4,618	0	6,750,020
1991	59,122	6,259,893	54,115	7,642,536	9,945	1,243	2,027	13,215	0	10,510,679
1992	80,131	8,435,312	72,892	10,351,553	13,671	1,710	2,806	18,187	0	14,255,669
1993	84,371	8,885,273	76,858	10,904,435	14,608	1,827	3,026	19,461	0	15,068,309
1994	85,698	8,926,755	76,794	10,959,041	14,409	1,801	3,070	19,280	0	15,145,690
1995	101,792	10,539,433	90,436	12,943,057	16,957	2,119	3,704	22,820	0	18,013,188
1996	124,074	12,810,361	109,783	15,730,703	20,640	2,580	4,621	27,841	0	21,369,059
1997	28,259	13,168,230	112,960	16,102,652	21,382	2,674	4,872	28,928	0	21,970,359
1998	27,174	12,662,268	108,619	15,483,941	20,562	2,571	4,685	27,818	0	21,126,192
1999	53,545	17,454,651	149,123	21,587,353	28,348	3,543	6,765	38,656	0	29,200,538
2000	70,117	19,805,800	168,259	25,135,976	32,271	9,794	7,996	50,061	0	33,737,389
2001	69,001	19,490,499	165,580	24,751,444	31,757	9,638	7,869	49,264	0	33,419,720
2002	71,126	20,091,004	170,682	25,534,301	32,736	9,935	8,112	50,783	0	34,452,492
2003	74,063	20,920,403	177,728	26,588,412	34,087	10,345	8,446	52,878	0	35,874,763
2004	74,138	20,941,743	177,910	26,615,534	34,121	10,356	8,456	52,933	0	35,911,363
2005	69,992	19,770,593	167,960	25,127,082	32,213	9,776	7,983	49,972	0	33,903,044
2006	75,738	20,330,228	181,750	27,239,381	34,858	10,579	8,638	54,075	0	36,735,870
2007	72,116	19,358,097	173,060	25,936,877	33,191	10,073	8,225	51,489	0	34,932,325
2008	117,622	31,573,085	282,260	42,303,077	54,135	16,429	13,415	83,979	0	56,974,657
2009	135,962	36,495,872	326,269	48,898,858	62,576	18,991	15,506	97,073	0	65,857,993
2010	130,645	35,068,622	313,510	46,986,561	60,128	18,248	14,900	93,276	0	63,282,470
2011	139,680	37,494,062	335,193	50,236,275	64,287	19,510	15,930	99,727	0	67,659,252
2012	139,823	37,532,206	335,534	50,287,383	64,353	19,530	15,947	99,830	0	67,728,087
2013	146,695	39,376,973	352,026	52,759,089	67,516	20,490	16,730	104,736	0	71,057,029
2014	151,650	40,707,081	363,917	54,541,227	69,796	21,182	17,296	108,274	0	73,457,250
2015	158,843	42,637,764	381,177	57,128,045	73,106	22,187	18,116	113,409	0	76,941,231
2016	160,320	43,034,253	384,721	57,659,278	73,786	22,393	18,284	114,463	0	77,656,706
2017	158,153	42,452,578	379,521	56,879,925	72,789	22,090	18,037	112,916	0	76,607,056
2018	140,957	37,836,624	338,255	50,695,257	64,874	19,688	16,076	100,638	0	68,277,417
2019	151,019	40,537,733	362,403	54,314,327	69,506	21,094	17,224	107,824	0	73,151,658
2020	140,059	37,595,718	336,102	50,372,479	64,461	19,563	15,974	99,998	0	67,842,695
2021	141,442	37,967,001	339,421	50,869,941	65,098	19,756	16,131	100,985	0	68,512,687
2022	137,081	36,796,187	328,954	49,301,232	63,091	19,147	15,634	97,872	0	66,399,918
2023	136,981	36,769,468	328,715	49,265,431	63,045	19,133	15,623	97,801	0	66,351,701
2024	132,067	35,450,336	316,922	47,497,998	60,783	18,447	15,062	94,292	0	63,971,287
2025	120,291	32,289,410	288,664	43,262,843	55,363	16,802	13,719	85,884	0	58,267,291
2026	109,404	29,367,148	262,539	39,347,461	50,353	15,281	12,477	78,111	0	52,993,971
2027	120,119	32,243,230	288,251	43,200,968	55,284	16,778	13,699	85,761	0	58,183,955
2028	92,161	24,738,585	221,160	33,145,898	42,417	12,873	10,511	65,801	0	44,641,581
2029	100,370	26,942,103	240,859	36,098,272	46,195	14,019	11,447	71,661	0	48,617,899
2030	0	0	0	0	0	0	0	0	0	0
2031	0	0	0	0	0	0	0	0	0	0
2032	0	0	0	0	0	0	0	0	0	0
2033	0	0	0	0	0	0	0	0	0	0
2034	0	0	0	0	0	0	0	0	0	0
2035	0	0	0	0	0	0	0	0	0	0
<b>TOTAL</b>	<b>4,285,883</b>	<b>1,066,024,557</b>	<b>9,428,559</b>	<b>1,407,318,778</b>	<b>1,792,569</b>	<b>516,465</b>	<b>442,629</b>	<b>2,751,663</b>	<b>0</b>	<b>1,898,710,809</b>

**TABLE B-23. Total Transportation and Delta Water Charge for Each Contractor**

(in dollars)

Sheet 1 of 4

Calendar Year	NORTH BAY AREA			SOUTH BAY AREA				CENTRAL COASTAL AREA		
	Napa County FC&WCD	Solano County WA	Total	Alameda County FC&WCD, Zone 7	Alameda County Water District	Santa Clara Valley Water District	Total	San Luis Obispo County FC&WCD	Santa Barbara County FC&WCD	Total
	[1]	[2]	[3]	[4]	[5]	[6]	[7]	[8]	[9]	[10]
1961	0	0	0	0	0	0	0	0	0	0
1962	0	0	0	11,750	43,787	21,132	76,669	0	0	0
1963	0	0	0	199,673	190,236	447,594	837,503	0	0	0
1964	0	0	0	263,210	277,398	621,174	1,161,782	6,694	21,659	28,353
1965	0	0	0	373,722	404,239	1,157,791	1,935,753	13,751	36,017	49,768
1966	18,057	0	18,057	419,362	421,628	1,412,600	2,253,589	26,516	61,329	87,845
1967	41,560	0	41,560	552,988	548,387	1,862,808	2,964,183	56,451	118,225	174,675
1968	128,588	0	128,588	682,772	633,066	2,178,036	3,493,875	115,927	229,740	345,667
1969	254,662	0	254,662	817,381	583,307	2,298,275	3,698,964	185,118	358,783	543,901
1970	277,493	0	277,493	903,698	640,164	2,787,493	4,331,355	200,110	387,595	587,705
1971	227,419	0	227,419	845,172	675,059	2,806,541	4,326,773	202,373	392,830	595,203
1972	224,922	0	224,922	929,182	822,262	3,027,272	4,778,716	209,016	406,506	615,521
1973	221,035	31,353	252,388	915,628	716,357	3,120,308	4,752,294	206,516	402,639	609,155
1974	240,442	32,924	273,366	956,223	746,798	3,324,543	5,027,565	208,503	407,005	615,508
1975	237,400	36,276	273,676	1,014,614	792,919	3,213,566	5,021,099	225,853	439,787	665,639
1976	271,231	40,819	312,050	1,127,672	943,328	3,362,062	5,433,062	228,933	447,212	676,146
1977	293,565	45,078	338,643	1,096,296	922,067	3,302,979	5,321,342	238,656	468,632	707,288
1978	273,807	49,159	322,966	1,185,091	935,682	3,712,097	5,832,870	245,286	484,166	729,452
1979	289,415	53,320	342,735	1,281,664	1,009,429	3,819,046	6,110,139	243,065	483,342	726,406
1980	310,779	86,049	396,827	1,434,637	1,173,659	4,118,582	6,726,878	282,209	540,456	822,665
1981	347,710	112,817	460,527	1,543,165	1,348,984	4,507,072	7,399,221	307,018	596,566	903,584
1982	438,260	141,798	580,058	1,623,491	1,369,396	4,940,900	7,933,788	328,168	682,443	1,010,611
1983	354,703	163,242	517,946	1,493,777	1,259,998	4,909,747	7,663,523	357,171	701,981	1,059,152
1984	467,232	246,623	713,856	1,803,809	1,478,252	6,869,751	10,151,811	409,482	800,953	1,210,435
1985	735,929	386,187	1,122,116	2,301,644	2,224,952	7,795,980	12,322,577	500,648	969,826	1,470,474
1986	1,119,826	714,023	1,833,849	2,170,269	2,013,959	8,193,339	12,377,567	536,703	1,037,924	1,574,627
1987	1,773,371	1,581,733	3,355,104	2,666,788	2,505,517	7,979,748	13,152,053	570,595	1,148,863	1,719,458
1988	2,349,015	2,524,068	4,873,083	2,727,958	2,774,284	7,829,776	13,332,017	673,020	1,439,487	2,112,507
1989	2,548,170	3,700,620	6,248,790	2,711,919	2,515,323	7,758,335	12,805,577	772,517	1,814,603	2,587,120
1990	2,899,410	3,848,146	6,747,556	3,147,224	2,929,625	8,354,874	14,431,724	933,311	2,046,195	2,979,506
1991	2,940,701	4,169,425	7,110,126	2,419,152	2,384,093	6,430,306	11,233,550	979,649	2,366,642	3,346,291
1992	2,797,105	4,144,190	6,941,295	2,893,617	2,926,955	7,656,397	13,476,970	1,118,743	2,526,627	3,645,370
1993	2,854,875	4,171,687	7,026,562	3,750,390	2,977,192	8,849,446	15,577,028	1,185,596	2,725,769	3,911,365
1994	2,987,314	4,224,485	7,211,799	3,787,480	3,586,091	9,612,990	16,986,561	1,335,886	3,517,570	4,853,456
1995	2,960,697	4,404,411	7,365,108	4,036,117	3,313,187	8,393,269	15,742,573	1,647,663	6,194,234	7,841,898
1996	3,044,394	4,897,402	7,941,796	3,643,954	3,178,232	9,227,992	16,050,178	2,591,704	15,229,004	17,820,707
1997	4,337,378	4,733,999	9,071,377	3,870,462	3,145,383	9,337,451	16,353,296	3,002,323	23,731,434	26,733,758
1998	2,935,879	4,589,402	7,525,281	4,379,860	3,203,980	9,084,489	15,768,329	3,255,634	28,393,820	31,649,454
1999	3,156,996	5,075,250	8,232,245	4,173,375	3,677,678	11,396,077	19,247,130	3,803,893	29,636,434	33,440,327
2000	3,467,748	5,635,248	9,102,996	5,821,231	3,611,498	10,262,277	19,695,007	3,787,594	30,647,075	34,434,669
2001	4,088,267	6,392,286	10,480,553	9,864,297	4,111,332	12,079,508	26,055,137	4,340,425	32,650,491	36,990,916
2002	4,337,473	6,594,347	10,931,820	13,408,474	4,116,491	13,231,736	30,756,700	4,068,070	32,385,927	36,453,998
2003	4,455,764	6,938,251	11,394,015	10,039,350	3,833,341	12,012,443	25,885,134	4,142,162	32,661,222	36,803,384
2004	4,939,165	7,360,960	12,300,125	8,215,874	4,117,563	11,429,537	23,762,974	4,152,816	33,141,215	37,294,031
2005	4,310,493	6,673,880	10,984,374	8,314,558	4,283,178	12,218,243	24,815,979	4,285,278	33,351,415	37,636,692
2006	4,223,437	6,218,539	10,441,977	8,349,015	4,300,666	12,411,926	25,061,607	4,200,800	33,390,736	37,591,536
2007	4,718,984	7,443,233	12,162,217	9,449,002	4,855,053	13,753,219	28,057,275	4,484,531	35,340,271	39,824,803
2008	5,503,929	7,457,378	12,961,307	11,538,462	6,134,512	16,114,886	33,787,860	7,408,817	37,038,627	44,447,444
2009	6,436,977	8,394,366	14,831,343	13,566,826	6,997,635	19,465,868	40,030,330	8,958,259	41,727,578	50,685,837
2010	6,382,237	8,372,559	14,754,796	12,771,958	6,720,042	18,377,853	37,869,852	8,115,252	40,069,548	48,184,800
2011	6,418,355	8,132,104	14,550,459	13,461,841	7,122,152	19,517,870	40,101,864	8,365,748	39,696,066	48,061,814
2012	6,480,479	8,175,021	14,655,500	13,559,555	7,151,231	19,601,736	40,312,523	8,465,865	39,969,481	48,435,346
2013	6,562,796	8,128,700	14,691,496	13,665,006	7,450,298	19,251,883	40,367,187	8,421,872	40,075,892	48,497,764
2014	6,550,668	8,072,200	14,622,868	13,493,118	7,050,673	18,332,417	38,876,209	8,150,718	39,683,848	47,834,566
2015	6,628,386	8,111,120	14,739,506	13,578,869	7,041,947	18,166,972	38,787,768	8,200,668	39,873,656	48,074,324
2016	6,666,823	8,123,265	14,790,088	13,732,055	7,111,139	18,232,453	39,075,647	8,269,988	40,015,825	48,285,814
2017	6,667,123	8,098,992	14,766,115	13,445,207	6,989,337	17,852,802	38,267,347	8,133,737	39,736,533	47,870,270
2018	6,581,953	8,019,701	14,601,654	13,157,182	6,897,969	17,622,117	37,677,268	8,098,096	39,433,054	47,531,150
2019	6,643,713	8,096,322	14,740,035	13,441,311	7,018,132	17,902,051	38,361,494	8,246,763	39,838,043	48,084,806
2020	6,587,926	7,990,144	14,578,070	13,005,489	6,790,042	17,357,155	37,152,687	7,977,042	39,196,413	47,173,455
2021	6,605,497	7,999,118	14,604,615	13,003,185	6,789,320	17,357,862	37,150,367	7,981,895	39,223,928	47,205,824
2022	6,553,716	7,945,217	14,498,933	12,784,484	6,671,165	17,077,766	36,533,416	7,833,358	38,891,857	46,725,215
2023	6,553,574	7,910,319	14,463,892	12,865,180	6,713,930	17,177,172	36,756,283	7,865,137	38,945,671	46,810,808
2024	6,569,216	7,913,347	14,482,564	13,028,422	6,807,429	17,379,045	37,214,897	7,996,962	39,117,800	47,114,762
2025	6,507,136	7,835,652	14,342,788	12,694,237	6,637,405	16,957,370	36,288,652	7,865,284	38,716,816	46,582,100
2026	6,468,296	7,774,771	14,243,067	12,860,669	6,730,480	17,157,626	36,748,776	7,929,910	38,679,388	46,609,297
2027	6,491,023	7,820,879	14,311,902	12,787,409	6,683,762	17,070,636	36,541,807	7,874,492	38,728,219	46,602,714
2028	6,389,641	7,663,188	14,052,829	12,567,556	6,584,170	16,780,578	35,932,303	7,805,938	38,208,997	46,014,934
2029	6,402,773	7,693,963	14,096,735	12,546,763	6,566,627	16,757,510	35,870,900	7,772,167	38,259,590	46,031,757
2030	6,034,954	7,130,303	13,165,257	11,730,252	6,191,460	15,693,665	33,615,377	7,495,213	36,365,858	43,861,072
2031	6,007,922	7,102,031	13,109,953	11,578,951	6,108,920	15,503,632	33,191,503	7,413,331	36,208,676	43,622,008
2032	6,011,783	7,092,724	13,104,506	11,719,362	6,186,770	15,678,314	33,584,446	7,504,532	36,372,866	43,877,398
2033	6,036,640	7,095,845	13,132,485	11,950,993	6,316,204	15,971,784	34,238,980	7,706,174	36,746,351	44,452,525
2034	5,921,632	6,983,240	12,904,871	11,742,515	6,200,729	15,707,612	33,650,856	7,543,922	36,448,967	43,992,889
2035	5,748,936	6,814,178	12,563,114	11,728,468	6,187,085	15,685,182	33,600,735	7,501,493	36,366,112	43,867,605
<b>TOTAL</b>	<b>256,004,775</b>	<b>325,405,879</b>	<b>581,410,654</b>	<b>500,722,316</b>	<b>282,352,182</b>	<b>778,692,547</b>	<b>1,561,767,045</b>	<b>283,569,011</b>	<b>1,478,450,308</b>	<b>1,762,019,319</b>

**TABLE B-23. Total Transportation and Delta Water Charge for Each Contractor**

(in dollars)

Sheet 2 of 4

SAN JOAQUIN VALLEY AREA									
Calendar Year	Dudley Ridge Water District	Empire West Side Irrigation District	Future Contractor San Joaquin Valley	Kern County Water Agency		County of Kings	Oak Flat Water District	Tulare Lake Basin Water Storage District	Total
				Municipal and Industrial	Agri-cultural				
	[11]	[12]	[13]	[14]	[15]	[16]	[17]	[18]	[19]
1961	0	0	0	0	0	0	0	0	0
1962	0	0	0	0	0	0	0	0	0
1963	0	0	0	0	0	0	0	0	0
1964	0	0	2,724	0	0	0	0	0	2,724
1965	0	0	6,027	73,544	0	0	0	0	79,571
1966	0	0	12,035	137,284	0	0	0	0	149,319
1967	0	0	26,249	267,525	0	0	0	0	293,774
1968	225,081	19,365	54,573	445,315	1,709,258	16,944	19,651	307,369	2,797,555
1969	241,258	10,888	87,557	524,952	2,728,443	16,821	19,385	458,997	4,088,302
1970	306,392	34,324	94,656	573,846	3,878,184	21,431	30,407	521,421	5,460,661
1971	327,829	37,052	95,676	605,729	5,199,068	27,171	34,689	712,682	7,039,896
1972	381,522	40,313	98,769	631,452	7,166,766	26,469	63,830	1,985,483	10,394,605
1973	398,867	38,935	97,531	1,025,724	7,296,692	28,813	39,275	782,096	9,707,932
1974	507,333	40,149	98,440	1,144,626	8,007,512	29,540	42,574	1,042,540	10,912,715
1975	679,873	40,598	106,683	1,197,000	9,386,571	31,236	48,190	1,555,688	13,047,839
1976	719,401	43,119	108,064	1,323,673	10,633,199	32,663	52,127	1,441,576	14,353,822
1977	579,665	39,036	112,534	1,367,237	10,947,502	34,430	54,232	1,137,532	14,272,167
1978	698,210	36,029	115,500	1,565,716	13,280,668	38,924	59,049	1,171,492	16,965,587
1979	781,527	47,872	114,232	1,668,783	15,357,216	43,061	70,641	1,725,436	19,808,768
1980	962,482	49,607	125,929	1,770,094	16,997,210	48,017	94,960	1,671,677	21,719,976
1981	1,211,421	83,973	134,147	2,430,626	22,599,536	66,491	100,654	2,282,712	28,909,561
1982	1,247,537	70,167	135,036	2,523,485	24,995,186	70,658	108,301	2,277,393	31,427,763
1983	1,181,806	52,517	149,180	2,084,871	24,641,630	75,438	87,449	506,684	28,779,574
1984	1,491,295	28,499	164,483	3,396,201	33,369,091	94,317	121,442	1,540,842	40,206,170
1985	1,767,100	129,929	184,883	3,891,023	39,338,822	117,579	139,523	2,815,576	48,384,435
1986	2,008,942	79,306	180,423	4,079,656	43,439,532	136,711	153,179	3,653,233	53,730,981
1987	1,884,148	95,224	179,850	4,570,657	42,711,287	137,328	151,420	3,746,121	53,476,034
1988	1,969,128	109,602	193,712	4,734,317	44,648,019	138,274	166,579	3,900,591	55,840,222
1989	2,123,784	101,729	187,891	4,677,170	46,839,923	137,082	166,406	4,381,976	58,615,961
1990	1,883,417	86,933	221,368	4,827,700	45,616,375	121,149	148,709	3,959,933	56,865,584
1991	1,688,663	80,222	220,258	4,535,666	37,492,030	103,904	134,719	3,500,943	47,756,406
1992	2,234,348	105,041	241,431	5,549,954	48,689,126	143,779	175,702	4,539,773	61,679,154
1993	2,456,503	120,044	264,933	5,805,843	54,590,293	161,518	195,267	5,293,627	68,888,028
1994	2,261,326	107,549	306,333	5,210,088	52,060,833	145,620	178,079	4,666,327	64,936,156
1995	2,857,787	115,466	304,270	6,621,268	60,520,989	180,796	210,412	5,525,161	76,336,150
1996	2,050,384	125,156	389,175	6,670,890	58,602,966	178,468	190,224	7,090,926	75,297,989
1997	2,671,647	100,561	276,653	6,521,730	62,217,616	138,112	212,224	4,713,057	82,105,643
1998	2,609,980	119,879	381,817	5,812,488	53,920,817	143,429	203,980	4,967,345	68,159,736
1999	2,667,386	134,281	366,550	6,378,154	56,834,412	181,841	215,956	7,276,595	74,055,175
2000	2,592,716	120,635	303,252	6,412,898	51,026,427	174,153	213,210	6,169,933	67,013,223
2001	3,260,205	145,481	327,961	6,008,079	58,222,708	192,128	259,055	6,433,655	74,849,271
2002	2,988,228	127,741	321,473	6,896,368	52,946,848	187,564	238,960	5,756,471	69,463,653
2003	3,033,856	131,388	339,996	7,207,195	55,515,288	202,248	237,846	6,063,242	72,731,059
2004	3,080,798	160,531	343,920	7,898,266	54,106,780	345,076	239,310	5,548,238	71,722,918
2005	3,679,962	171,513	356,712	7,271,558	65,146,096	671,560	241,814	6,476,091	84,015,306
2006	3,703,332	163,876	301,410	7,314,328	63,301,080	523,930	245,125	5,773,857	81,326,937
2007	3,471,327	163,792	346,758	7,959,746	62,217,616	531,722	261,650	6,050,140	81,002,749
2008	4,168,247	201,992	389,021	9,574,563	74,485,336	676,931	316,081	6,977,987	96,790,158
2009	5,199,337	250,857	421,926	11,711,199	89,722,814	821,148	393,385	8,517,325	117,037,992
2010	4,815,653	230,432	412,792	10,763,649	83,125,176	760,780	368,178	7,734,585	108,211,245
2011	4,749,969	226,995	421,700	10,827,232	82,866,899	757,310	373,898	7,624,961	107,848,963
2012	4,757,167	227,365	422,239	10,861,844	83,225,480	758,676	372,399	7,636,164	108,261,334
2013	4,837,498	231,333	422,893	12,741,557	84,417,299	771,500	381,612	7,763,077	111,566,769
2014	4,551,283	216,189	420,461	11,816,833	79,830,259	724,693	358,068	7,320,927	105,238,714
2015	4,648,650	221,037	417,387	11,963,131	81,239,526	740,215	367,233	7,474,375	107,071,554
2016	4,780,834	227,906	411,000	12,269,037	83,349,751	761,649	379,056	7,679,894	109,859,128
2017	4,653,262	221,305	396,938	11,778,563	81,296,040	740,957	367,881	7,481,308	106,936,254
2018	4,598,012	218,994	374,457	11,631,984	80,820,057	723,362	361,802	7,389,684	106,118,352
2019	4,766,712	227,482	365,600	11,995,835	83,383,148	749,716	376,713	7,654,768	109,519,994
2020	4,602,143	219,241	364,069	11,514,164	80,767,111	722,884	363,337	7,395,801	105,948,751
2021	4,596,813	218,916	363,121	11,483,700	80,690,808	721,809	362,561	7,388,005	105,825,733
2022	4,509,935	214,517	362,400	11,236,484	79,292,713	707,640	355,385	7,251,775	103,930,850
2023	4,567,406	217,531	361,709	11,380,489	80,186,919	716,953	360,866	7,340,895	105,132,767
2024	4,635,057	221,235	361,294	11,578,015	81,378,112	728,257	366,730	7,444,095	106,712,995
2025	4,442,834	211,574	361,052	11,127,747	78,559,066	697,445	348,743	7,141,939	102,890,401
2026	4,578,294	219,035	360,212	11,459,627	80,707,776	719,860	362,779	7,348,290	105,755,873
2027	4,525,009	215,876	360,561	11,315,460	79,793,404	710,640	357,009	7,269,276	104,547,234
2028	4,429,919	211,855	357,101	11,111,190	78,583,972	696,262	349,605	7,112,267	102,852,171
2029	4,421,429	211,130	357,208	11,073,100	78,357,048	694,424	348,493	7,101,903	102,564,735
2030	4,067,270	196,001	356,632	10,341,587	73,910,649	640,929	320,195	6,518,181	96,351,445
2031	3,989,252	191,909	356,014	10,141,940	72,734,117	627,773	312,607	6,397,112	94,750,724
2032	4,056,022	195,415	354,729	10,294,231	73,735,442	638,736	319,040	6,500,752	96,094,367
2033	4,136,311	199,611	355,034	10,602,909	75,291,955	651,884	324,040	6,625,221	98,186,965
2034	4,058,675	195,548	354,456	10,314,698	73,857,440	638,938	318,618	6,504,819	96,243,192
2035	4,124,629	199,003	353,091	10,600,133	75,097,309	649,306	323,153	6,607,138	97,953,762
<b>TOTAL</b>	<b>197,244,087</b>	<b>9,548,606</b>	<b>19,096,146</b>	<b>475,123,623</b>	<b>3,654,071,284</b>	<b>25,647,079</b>	<b>15,515,472</b>	<b>342,626,975</b>	<b>4,738,873,273</b>

**TABLE B-23. Total Transportation and Delta Water Charge for Each Contractor**

(in dollars)

Sheet 3 of 4

Calendar Year	SOUTHERN CALIFORNIA AREA									
	Antelope Valley - East Kern Water Agency	Castaic Lake Water Agency	Coachella Valley Water District	Crestline - Lake Arrowhead Water Agency	Desert Water Agency	Littlerock Creek Irrigation District	Mojave Water Agency	Palmdale Water District	San Bernardino Valley Municipal Water District	San Gabriel Valley Municipal Water District
	[20]	[21]	[22]	[23]	[24]	[25]	[26]	[27]	[28]	[29]
1961	0	0	0	0	0	0	0	0	0	0
1962	0	0	0	0	0	0	0	0	0	0
1963	33,772	0	0	0	0	0	0	0	51,711	0
1964	63,539	27,438	16,286	4,368	37,145	1,142	28,427	8,202	82,782	34,973
1965	119,810	52,989	28,459	7,191	40,756	2,081	50,300	15,217	135,023	35,333
1966	217,978	101,232	51,184	12,474	73,129	3,752	90,369	27,670	232,426	61,445
1967	421,745	210,746	98,904	23,464	141,365	7,282	175,119	54,006	433,210	115,536
1968	743,770	491,202	176,688	41,496	251,125	12,866	311,125	95,438	781,930	208,864
1969	1,072,210	742,174	264,900	61,208	370,850	18,688	459,029	138,023	1,205,471	321,659
1970	1,395,411	942,159	371,728	89,673	519,163	25,223	633,101	184,783	1,777,649	467,431
1971	1,727,337	1,136,599	503,422	128,321	712,537	31,827	857,295	231,214	2,537,458	659,218
1972	2,207,351	1,381,721	682,096	185,824	989,700	43,760	1,179,479	287,548	3,757,581	950,069
1973	2,359,904	1,430,196	829,097	190,946	1,216,863	46,049	1,270,266	313,372	4,025,516	960,784
1974	2,480,655	1,525,719	853,731	204,028	1,256,738	48,922	1,329,140	331,627	4,462,696	1,104,245
1975	2,698,360	1,616,790	900,445	219,242	1,332,005	53,231	1,415,196	355,193	4,637,837	1,207,793
1976	3,162,808	1,653,503	958,179	232,081	1,424,703	57,721	1,491,513	381,199	4,837,349	1,278,480
1977	3,144,576	1,741,404	859,286	245,063	1,267,009	54,199	1,578,902	406,543	5,093,211	1,336,049
1978	3,592,565	1,874,512	1,058,836	255,418	1,567,751	56,795	1,626,161	419,949	5,090,895	1,373,766
1979	4,266,157	1,954,357	1,144,724	267,741	1,689,966	60,273	1,801,508	449,679	5,135,792	1,341,866
1980	4,950,456	2,092,773	1,254,546	295,300	1,890,349	67,594	1,973,536	498,972	5,646,551	1,484,871
1981	5,778,188	2,562,158	1,413,847	328,765	2,140,325	100,740	2,291,633	603,182	6,460,754	1,688,045
1982	5,537,026	2,725,248	1,499,972	346,669	2,284,051	82,284	2,266,386	641,909	6,751,715	1,929,385
1983	6,287,405	2,795,886	2,021,337	380,786	3,118,525	88,372	2,461,965	658,528	6,963,597	1,808,463
1984	7,662,769	3,874,645	3,123,607	497,530	4,874,874	96,480	2,727,369	727,732	8,052,068	2,597,938
1985	9,493,745	4,340,763	3,957,883	601,871	6,209,843	103,693	2,917,337	959,565	8,892,175	2,686,498
1986	9,461,919	4,976,242	4,418,531	647,576	6,954,134	130,208	3,100,878	1,223,753	9,141,638	3,398,233
1987	9,496,029	4,833,777	4,286,505	678,027	6,830,144	240,859	3,155,331	1,254,957	10,543,136	3,998,610
1988	9,094,367	5,020,573	4,343,583	704,352	6,996,687	158,832	3,329,497	1,044,110	11,093,980	3,270,823
1989	10,984,769	5,029,933	4,050,973	691,132	6,579,291	210,621	3,410,296	1,746,666	10,810,769	3,453,364
1990	12,376,227	5,497,992	4,745,014	729,168	7,663,400	331,158	3,641,164	1,953,805	11,721,704	4,220,945
1991	9,235,841	4,611,750	3,298,997	688,804	5,277,044	221,152	4,500,593	1,639,984	11,103,608	3,642,283
1992	11,791,946	5,800,432	3,452,415	612,831	5,529,109	174,984	5,478,681	1,532,224	11,142,805	3,693,763
1993	12,205,052	5,447,090	3,656,000	617,132	5,863,795	211,890	5,369,519	1,753,869	12,105,846	4,041,979
1994	14,273,855	6,013,545	3,681,573	694,352	5,904,427	277,998	6,320,377	2,090,620	12,730,316	4,776,992
1995	14,140,141	6,389,190	4,503,309	661,742	7,259,099	212,229	5,512,802	1,952,389	12,203,021	4,480,563
1996	14,566,548	6,620,327	7,455,778	710,580	12,127,573	208,342	5,610,423	2,300,101	12,729,472	4,598,694
1997	15,136,098	6,513,979	7,071,320	750,347	8,455,419	207,872	6,032,398	2,342,092	12,497,503	4,897,093
1998	13,675,269	6,147,343	6,170,078	717,166	6,979,253	209,222	7,636,684	1,950,236	14,302,951	4,179,636
1999	15,414,845	6,655,783	5,183,636	824,087	7,122,924	213,822	8,256,243	2,353,660	15,736,666	5,119,459
2000	14,840,895	10,291,031	3,644,461	795,374	5,564,450	186,799	8,219,101	2,086,398	15,534,114	4,266,456
2001	24,997,745	15,961,563	4,696,893	1,000,638	7,573,227	199,053	8,923,127	4,015,713	21,514,212	4,414,836
2002	16,463,221	13,234,778	3,965,191	966,628	6,366,369	182,322	8,104,437	3,419,582	22,466,211	5,843,641
2003	17,806,850	14,145,518	4,079,902	936,060	6,554,449	187,286	9,761,825	2,948,806	20,753,070	5,989,099
2004	18,491,080	15,280,708	4,662,074	1,028,599	6,523,155	195,699	9,821,287	3,153,599	24,819,674	5,376,077
2005	19,251,803	14,367,672	18,620,948	806,044	11,514,101	193,041	9,808,840	3,245,685	23,399,033	5,716,010
2006	20,160,336	14,068,306	30,880,089	831,299	11,454,222	192,575	12,382,080	3,093,669	23,097,397	5,598,635
2007	24,197,562	17,391,986	30,384,997	1,161,067	11,212,705	196,655	16,673,362	4,220,402	30,170,479	5,058,196
2008	28,167,122	20,061,165	38,627,191	1,738,559	14,152,021	592,588	18,013,272	5,398,550	40,300,059	7,704,059
2009	31,379,339	21,725,938	52,865,376	1,885,606	20,248,623	752,880	20,726,448	7,156,937	48,860,823	12,196,731
2010	27,713,157	19,861,893	50,921,038	1,722,191	17,730,842	673,600	18,484,055	6,117,841	43,112,964	10,639,960
2011	29,899,991	20,371,018	55,896,913	1,786,574	19,028,318	737,705	19,294,511	6,721,088	44,784,007	11,115,706
2012	31,304,291	21,212,737	57,891,397	1,865,578	19,727,825	768,306	19,904,207	7,004,152	46,133,655	11,501,363
2013	30,355,520	23,034,558	57,599,051	1,852,040	19,593,645	766,771	20,655,835	6,988,002	45,652,673	11,386,000
2014	41,098,389	27,994,393	51,899,801	2,168,671	17,598,045	680,729	26,935,164	6,191,401	41,981,645	10,317,063
2015	41,317,105	28,211,580	52,165,620	2,156,141	17,656,152	684,354	27,094,441	6,224,452	41,734,383	10,283,878
2016	42,696,456	29,086,034	53,511,564	2,246,675	18,187,315	706,717	28,013,266	6,433,231	43,268,151	10,672,261
2017	40,991,406	27,989,864	51,903,133	2,149,012	17,525,906	678,751	26,932,601	6,178,912	41,562,051	10,223,634
2018	42,068,125	28,425,045	52,676,502	2,193,377	17,828,087	695,769	27,712,459	6,344,567	42,201,626	10,404,668
2019	42,971,168	28,870,817	53,904,522	2,247,617	18,240,520	710,088	28,152,706	6,479,615	43,142,840	10,652,286
2020	40,802,057	27,341,197	50,818,444	2,112,746	17,159,383	673,403	26,829,674	6,148,596	40,576,372	9,974,652
2021	40,628,613	27,132,598	50,414,545	2,067,267	16,965,734	669,417	26,661,384	6,118,215	39,732,786	9,781,001
2022	39,549,236	26,247,755	48,806,622	2,018,172	16,442,114	651,553	25,918,028	5,955,491	38,787,101	9,507,683
2023	39,886,435	26,512,544	48,115,449	2,045,234	16,413,345	656,844	26,130,548	6,005,763	39,150,540	9,589,781
2024	40,707,723	26,996,867	49,104,492	2,063,945	16,739,640	670,139	26,574,728	6,130,026	39,481,699	9,715,008
2025	39,985,044	26,380,975	48,020,698	2,028,278	16,403,143	658,210	26,143,638	6,022,406	38,852,625	9,538,510
2026	40,336,757	26,634,959	48,691,901	2,056,739	16,557,750	663,753	26,307,002	6,076,529	39,225,846	9,622,650
2027	40,161,115	26,352,863	47,881,560	2,026,734	16,387,419	661,022	26,208,849	6,048,955	38,746,408	9,518,537
2028	39,618,795	26,114,687	47,540,365	1,985,475	16,160,671	651,832	25,819,284	5,970,360	37,932,898	9,313,935
2029	39,502,036	25,799,612	47,405,720	2,009,052	16,153,201	650,012	25,753,244	5,951,985	38,390,891	9,396,020
2030	38,080,259	24,174,357	45,795,147	1,923,594	15,482,837	625,644	24,674,463	5,749,021	36,688,766	8,941,184
2031	37,830,687	23,773,257	45,599,710	1,865,115	15,314,619	621,558	24,566,506	5,711,975	35,678,914	8,719,586
2032	37,873,487	24,052,330	45,309,677	1,907,790	15,357,424	622,222	24,511,160	5,718,747	36,459,772	8,881,567
2033	40,345,873	25,472,495	48,187,278	2,003,078	16,308,756	662,398	26,182,404	6,092,631	38,040,919	9,355,437
2034	38,174,604	24,108,533	45,847,027	1,897,801	15,475,567	627,076	24,759,415	5,767,761	36,293,859	8,870,696
2035	40,932,620	25,236,525	48,699,380	2,056,261	16,473,841	671,827	26,376,015	6,185,186	38,916,433	9,538,531
TOTAL	1,461,857,347	938,750,326	1,585,421,548	77,951,791	677,026,493	24,520,562	879,319,406	232,003,909	1,574,343,712	400,449,935

**TABLE B-23. Total Transportation and Delta Water Charge for Each Contractor**

(in dollars)

Sheet 4 of 4

Calendar Year	SOUTHERN CALIFORNIA AREA (continued)				FEATHER RIVER AREA				South Bay Area Future Contractor	GRAND TOTAL
	San Gorgonio Pass Water Agency	The Metropolitan Water District of Southern California	Ventura County Watershed Protection District	Total	City Yuba City	County of Butte	Plumas of FC&WCD	Total County		
	[30]	[31]	[32]	[33]	[34]	[35]	[36]	[37]		
1961	0	0	0	0	0	0	0	0	0	0
1962	0	0	0	0	0	0	0	0	3,219	79,888
1963	0	690,539	0	776,021	0	0	0	0	12,626	1,626,150
1964	21,728	1,260,042	9,374	1,595,448	0	0	0	0	13,938	2,802,244
1965	21,859	2,179,810	17,760	2,706,589	0	0	405	405	28,937	4,801,023
1966	37,952	3,898,819	33,415	4,841,844	0	0	564	564	31,321	7,382,540
1967	71,260	7,691,085	68,133	9,511,856	0	0	562	562	47,718	13,034,327
1968	128,877	15,313,065	142,760	18,699,207	0	1,050	1,439	2,489	46,945	25,514,327
1969	198,704	23,145,744	215,144	28,213,803	0	1,225	4,119	5,344	52,963	36,857,938
1970	289,546	30,607,434	273,523	37,576,825	0	3,848	17,111	20,959	69,744	48,324,741
1971	409,205	39,946,463	342,325	49,223,221	0	4,546	19,182	23,728	55,532	61,491,771
1972	537,044	54,976,817	422,192	67,601,183	0	4,929	21,145	26,074	80,412	83,721,433
1973	587,814	59,575,172	435,541	73,241,520	0	7,059	21,772	28,831	54,219	88,646,338
1974	611,275	65,991,774	455,447	80,655,995	0	8,336	22,403	30,739	76,783	97,592,671
1975	644,464	71,813,105	478,284	87,371,944	0	9,416	23,517	32,933	84,547	106,497,678
1976	668,153	74,889,946	475,466	91,511,101	0	7,004	23,251	30,255	106,717	112,423,153
1977	696,350	73,320,946	506,941	90,250,479	0	16,917	24,054	40,971	98,618	111,029,507
1978	708,874	81,933,455	523,053	100,082,029	0	12,635	24,219	36,854	100,786	124,070,544
1979	712,699	83,583,809	526,278	102,934,849	0	16,575	28,346	44,921	119,352	130,887,169
1980	862,108	93,010,922	583,496	114,611,472	0	19,834	26,556	46,390	178,812	144,503,019
1981	946,788	112,152,065	672,397	137,138,887	0	21,682	34,558	56,240	185,347	175,053,366
1982	1,021,156	117,123,623	727,476	142,936,899	0	16,117	43,111	59,228	173,894	184,122,241
1983	1,076,102	118,970,809	854,111	147,485,886	0	15,202	29,405	44,607	220,926	185,771,614
1984	1,211,437	156,252,901	933,156	192,632,507	20,590	15,442	31,790	67,822	225,959	245,208,560
1985	1,287,602	194,946,283	993,495	237,390,754	24,050	16,976	32,399	73,425	340,322	301,104,103
1986	1,344,580	218,310,580	1,058,119	264,166,392	31,753	18,145	33,591	83,489	279,227	334,046,131
1987	1,379,421	204,838,227	1,056,160	251,991,183	37,071	17,794	33,378	88,243	345,116	324,127,192
1988	1,465,634	221,645,738	1,123,943	269,292,117	48,058	19,117	33,600	100,775	365,207	345,915,928
1989	1,505,285	230,306,788	1,232,220	280,102,107	61,184	20,809	37,183	119,176	422,329	360,811,060
1990	1,624,564	277,172,964	1,855,829	333,533,934	66,041	20,855	36,807	123,703	474,284	415,156,290
1991	1,720,675	221,864,964	1,549,791	269,355,486	180,212	22,526	42,194	244,932	214,683	339,261,475
1992	1,779,694	245,343,167	1,503,314	297,835,364	208,216	26,028	43,511	277,755	443,676	384,299,583
1993	1,943,123	219,215,370	1,551,085	273,981,750	209,613	26,203	47,582	283,398	599,571	370,267,702
1994	1,919,993	257,342,564	1,474,900	317,500,912	201,284	25,161	46,074	272,519	609,966	412,371,368
1995	1,982,578	225,839,767	1,568,231	286,705,060	216,944	27,118	50,016	294,078	534,971	394,819,838
1996	1,651,010	235,386,436	1,622,470	305,587,754	217,250	27,156	56,618	301,024	571,857	423,571,306
1997	1,759,496	245,429,286	1,777,095	314,769,997	236,300	29,847	59,910	326,057	428,638	438,478,767
1998	1,952,117	227,219,125	1,797,346	292,936,426	128,021	29,927	53,588	211,536	465,095	416,715,858
1999	2,268,577	254,701,324	1,866,824	325,717,850	254,675	31,834	57,951	344,460	559,471	461,596,659
2000	2,568,371	253,885,149	1,968,875	323,851,473	262,163	79,001	61,071	402,235	0	454,499,602
2001	3,554,006	444,807,534	2,263,314	543,921,860	261,699	93,471	62,424	417,594	0	692,715,332
2002	4,965,846	335,679,236	2,308,016	623,965,477	206,107	95,018	64,666	425,791	0	571,997,439
2003	6,091,303	362,979,799	2,324,968	454,558,935	262,547	93,638	68,952	425,137	0	601,797,664
2004	6,576,913	407,038,943	2,550,329	505,518,137	260,408	93,662	29,281	383,351	0	650,981,536
2005	6,932,726	381,985,133	2,075,278	497,916,315	267,244	39,477	28,805	335,526	0	655,704,191
2006	7,456,249	363,839,305	2,058,570	495,112,731	272,993	40,686	79,797	393,476	0	649,928,264
2007	8,395,922	452,401,599	2,597,589	604,062,162	301,929	44,023	49,150	395,102	0	765,504,307
2008	10,877,547	586,680,354	5,077,631	777,480,118	328,871	811,214	90,136	1,230,221	1	966,697,109
2009	14,411,183	644,993,997	6,862,950	884,096,632	398,322	987,354	107,537	1,493,213	2	1,108,175,349
2010	13,045,442	560,541,189	5,885,378	776,449,550	395,874	980,021	108,742	1,484,637	0	986,954,880
2011	13,418,746	591,238,192	6,213,072	820,505,842	400,033	981,283	115,311	1,496,627	0	1,032,565,569
2012	13,649,319	611,248,479	6,463,807	848,675,123	400,099	981,303	118,089	1,499,491	0	1,061,839,316
2013	13,335,921	597,288,102	6,478,447	834,986,566	403,262	982,263	121,978	1,507,503	0	1,051,615,285
2014	12,460,490	578,038,356	5,843,290	823,207,437	405,542	982,955	125,649	1,514,146	0	1,031,293,940
2015	12,396,358	580,339,629	5,878,794	826,142,885	408,852	983,960	129,518	1,522,330	0	1,036,338,386
2016	12,626,389	598,544,845	6,070,468	852,063,372	409,532	984,166	132,975	1,526,673	0	1,065,600,721
2017	12,355,079	575,484,665	5,823,533	819,798,547	408,535	983,863	132,731	1,525,129	0	1,029,163,662
2018	12,473,956	583,004,905	5,943,219	831,972,307	400,620	981,461	130,769	1,512,850	0	1,039,413,581
2019	12,605,825	593,329,324	6,029,839	847,337,168	405,252	982,867	129,285	1,517,404	0	1,059,560,902
2020	12,212,207	559,085,704	5,698,871	799,433,305	400,207	981,336	116,115	1,497,658	0	1,005,783,926
2021	12,094,277	551,528,106	5,646,202	789,440,146	400,844	981,529	115,449	1,497,822	0	995,724,507
2022	11,937,230	533,662,330	5,455,494	764,938,810	398,837	980,920	113,563	1,493,320	0	968,120,543
2023	11,982,675	537,237,955	5,512,492	769,239,605	398,791	980,906	113,551	1,493,248	0	973,896,604
2024	12,058,285	546,566,695	5,625,124	782,434,369	396,529	980,220	112,989	1,489,738	0	989,449,124
2025	11,962,758	533,349,680	5,501,658	764,847,625	391,109	978,575	111,648	1,481,332	0	966,432,897
2026	12,034,997	540,464,945	5,569,985	774,243,812	386,099	977,054	110,395	1,473,548	0	979,074,374
2027	11,950,981	531,146,768	5,491,197	762,582,459	391,030	978,551	111,632	1,481,213	0	966,067,326
2028	11,872,735	530,183,380	5,482,988	758,647,404	378,163	974,646	108,425	1,461,234	0	958,960,875
2029	11,913,442	523,361,675	5,395,988	751,682,879	381,941	975,792	109,366	1,467,099	0	951,714,107
2030	11,810,871	497,253,196	5,159,396	716,358,735	335,746	961,773	97,916	1,395,435	0	904,747,321
2031	11,669,875	486,221,667	5,067,224	702,640,693	335,746	961,773	97,926	1,395,445	0	888,710,325
2032	11,774,239	495,967,332	5,138,392	713,574,140	335,746	961,773	97,905	1,395,424	0	901,630,281
2033	12,054,938	520,408,278	5,447,403	750,561,891	335,746	961,773	97,915	1,395,434	0	941,968,280
2034	11,762,763	494,288,993	5,144,383	713,018,478	335,746	961,773	97,913	1,395,432	0	901,205,719
2035	12,172,116	523,172,764	5,420,569	755,852,072	335,746	961,773	97,902	1,395,421	0	945,232,710
TOTAL	428,509,722	23,275,139,130	208,201,831	31,763,495,711	14,999,172	28,303,166	4,659,389	47,961,727	8,723,731	40,464,251,460

**TABLE B-24. Equivalent Unit Charge for Water Supply for Each Contractor (a)**

(in dollars per acre-foot)

Project Service Area and Water Supply Contractor	Transportation Charge					Delta Water Charge	Water System Revenue Bond Surcharge	Total Equivalent Unit Charge
	Capital Cost Component	Minimum OMP&R Component	Off-Aqueduct Component	Variable OMP&R Component	Total			
	[1]	[2]	[3]	[4]	[5]	[6]	[7]	[8]
<b>FEATHER RIVER AREA</b>								
City of Yuba City	0.00	0.00	0.00	0.00	0.00	74.62	9.84	84.45
County of Butte	0.00	0.00	0.00	0.00	0.00	38.50	0.91	39.41
Plumas County Flood Control and Water Conservation District	26.54	3.53	0.00	0.00	30.07	36.98	5.05	72.11
Feather River Area	2.88	0.38	0.00	0.00	3.26	46.49	3.37	53.12
<b>NORTH BAY AREA</b>								
Napa County Flood Control and Water Conservation District	142.85	46.23	4.34	17.62	211.04	24.68	11.88	247.61
Solano County Water Agency	86.94	37.02	4.85	11.36	140.17	31.06	10.88	182.12
North Bay Area	107.79	40.45	4.66	13.70	166.60	28.69	11.25	206.53
<b>SOUTH BAY AREA</b>								
Alameda County Flood Control and Water Conservation District, Zone 7	37.69	42.20	7.96	25.79	113.64	29.98	7.70	151.33
Alameda County Water District	25.22	27.64	7.05	18.12	78.02	23.76	4.54	106.33
Santa Clara Valley Water District	22.35	20.39	6.41	13.55	62.71	16.77	3.27	82.75
South Bay Area	25.62	25.56	6.80	16.54	74.52	20.34	4.29	99.15
<b>SAN JOAQUIN VALLEY AREA</b>								
County of Kings	5.16	5.94	3.38	10.22	24.70	23.66	3.61	51.97
Dudley Ridge Water District	5.13	5.04	3.16	6.23	19.56	17.60	2.29	39.45
Empire West Side Irrigation District	2.02	4.33	2.40	5.59	14.34	18.83	1.76	34.93
Kern County Water Agency	9.30	9.73	4.83	8.48	32.34	20.63	2.42	55.39
Oak Flat Water District	2.02	2.42	1.95	3.83	10.22	17.33	1.75	29.30
Tulare Lake Basin Water Storage District	5.26	5.02	3.10	5.74	19.12	17.98	2.21	39.31
San Joaquin Valley Area	8.58	8.92	4.54	5.81	27.85	18.16	2.24	48.25
<b>CENTRAL COASTAL AREA</b>								
San Luis Obispo County Flood Control and Water Conservation District	178.31	91.08	13.70	128.27	411.36	69.00	22.40	502.76
Santa Barbara County Flood Control and Water Conservation District	774.86	132.53	17.68	113.08	1,038.15	56.34	56.26	1,150.75
Central Coastal Area	592.12	119.83	16.46	117.73	846.15	60.22	45.89	952.25
<b>SOUTHERN CALIFORNIA AREA</b>								
Antelope Valley-East Kern Water Agency	48.29	45.49	28.67	89.53	211.97	38.50	8.49	258.96
Castaic Lake Water Agency	53.05	47.73	22.46	61.56	184.80	33.32	13.48	231.60
Coachella Valley Water District	63.13	53.62	36.04	110.91	263.70	25.17	9.74	298.60
Crestline-Lake Arrowhead Water Agency	121.20	101.86	31.95	115.85	370.86	50.77	16.00	437.62
Desert Water Agency	46.24	42.46	48.20	62.47	199.38	22.38	6.72	228.47
Littlerock Creek Irrigation District	62.70	58.25	27.35	104.57	252.87	48.45	10.61	311.93
Mojave Water Agency	110.87	119.34	23.97	182.21	436.39	73.40	23.40	533.18
Palmdale Water District	52.55	51.48	35.95	119.14	259.11	46.65	9.47	315.23
San Bernardino Valley Municipal Water District	179.78	134.09	26.48	112.45	452.81	57.74	19.22	529.77
San Gabriel Valley Municipal Water District	99.65	85.83	41.07	77.04	303.59	40.13	12.83	356.55
San Geronio Pass Water Agency	605.10	253.93	30.02	248.29	1,137.34	67.60	13.99	1,218.93
The Metropolitan Water District of Southern California	79.17	60.15	35.18	61.52	236.02	35.17	10.30	281.49
Ventura County Watershed Protection District	144.59	112.58	21.04	147.08	425.29	68.88	21.18	515.35
Southern California Area	73.87	57.21	31.82	63.52	226.42	34.49	9.97	270.88
<b>ALL AREAS</b>	<b>48.52</b>	<b>36.32</b>	<b>18.93</b>	<b>38.19</b>	<b>141.96</b>	<b>28.11</b>	<b>6.83</b>	<b>176.90</b>

a) Hypothetical charges, which, if assessed on all Table A water delivered to date, all surplus water delivered prior to May 1, 1973, and all Table A water estimated to be delivered during the remainder of the project repayment period (Table B-5B), would provide a sum at the end of the period financially equivalent to all Transportation Charge and Delta Water Charge payments required under a water supply contract, considering interest at the Project Interest Rate, 4.608 percent per annum.



**TABLE B-25. Equivalent Unit Transportation Costs of Water Delivered from or through Each Aqueduct Reach (a)**

(in dollars per acre-foot)

Aqueduct Reach	Unit Costs of Reach (b)						Cumulative Unit Costs from the Delta					
	Capital Costs	Water System Revenue Bond Surcharge (c)	Minimum OMP&R	Off-Aqueduct Costs	Variable OMP&R	Total	Capital Costs	Water System Revenue Bond Surcharge (c)	Minimum OMP&R	Off-Aqueduct Costs	Variable OMP&R	Total
	[1]	[2]	[3]	[4]	[5]	[6]	[7]	[8]	[9]	[10]	[11]	[12]
<b>NBA</b>												
1	39.57	14.04	13.11	2.00	2.00	70.72	39.57	14.04	13.11	2.00	2.00	70.72
2	42.12	14.94	5.73	0.00	0.00	62.79	81.69	28.98	18.84	2.00	2.00	133.51
3A	7.51	2.66	11.39	3.84	3.24	28.64	89.20	31.64	30.23	5.84	5.24	162.15
3B	48.29	17.13	25.76	3.20	7.19	101.57	129.98	46.11	44.60	5.20	9.19	235.08
<b>SBA</b>												
1	6.92	2.45	15.36	5.20	7.50	37.43	8.85	3.13	18.38	7.68	11.00	49.04
2	0.65	0.23	1.74	0.00	0.00	2.62	9.50	3.36	20.12	7.68	11.00	51.66
4	2.18	0.77	2.96	0.00	0.00	5.91	11.68	4.13	23.08	7.68	11.00	57.57
5	4.57	1.62	2.32	0.00	0.00	8.51	16.25	5.75	25.40	7.68	11.00	66.08
6	0.26	0.09	0.24	0.00	0.00	0.59	16.51	5.84	25.64	7.68	11.00	66.67
7	2.02	0.72	0.45	0.00	0.00	3.19	18.53	6.56	26.09	7.68	11.00	69.86
8	2.75	0.98	0.75	0.00	0.00	4.48	21.28	7.54	26.84	7.68	11.00	74.34
9	5.68	2.02	2.79	0.00	0.00	10.49	26.96	9.56	29.63	7.68	11.00	84.83
<b>CA</b>												
1	1.93	0.68	3.02	2.48	3.50	11.61	1.93	0.68	3.02	2.48	3.50	11.61
2A	1.23	0.44	0.60	0.00	0.00	2.27	3.16	1.12	3.62	2.48	3.50	13.88
2B	0.63	0.22	0.30	0.00	0.00	1.15	3.79	1.34	3.92	2.48	3.50	15.03
3	0.55	0.20	0.22	0.00	0.00	0.97	4.34	1.54	4.14	2.48	3.50	16.00
4	0.87	0.31	1.50	1.18	1.58	5.44	5.21	1.85	5.64	3.66	5.08	21.44
5	0.67	0.24	0.30	0.00	0.00	1.21	5.88	2.09	5.94	3.66	5.08	22.65
6	0.17	0.06	0.15	0.00	0.00	0.38	6.05	2.15	6.09	3.66	5.08	23.03
7	1.01	0.36	0.36	0.00	0.00	1.73	7.06	2.51	6.45	3.66	5.08	24.76
8C	0.02	0.01	0.06	0.00	0.00	0.09	7.08	2.52	6.51	3.66	5.08	24.85
8D	0.39	0.14	0.29	0.00	0.00	0.82	7.47	2.66	6.80	3.66	5.08	25.67
9	0.33	0.12	0.27	0.00	0.00	0.72	7.80	2.78	7.07	3.66	5.08	26.39
10A	0.35	0.12	0.35	0.00	0.00	0.82	8.15	2.90	7.42	3.66	5.08	27.21
11B	0.51	0.18	0.22	0.00	0.00	0.91	8.66	3.08	7.64	3.66	5.08	28.12
12D	0.48	0.17	0.20	0.00	0.00	0.85	9.14	3.25	7.84	3.66	5.08	28.97
12E	0.34	0.12	0.34	0.00	0.00	0.80	9.48	3.37	8.18	3.66	5.08	29.77
13B	0.72	0.26	0.39	0.00	0.00	1.37	10.20	3.63	8.57	3.66	5.08	31.14
14A	2.79	0.99	3.03	2.05	2.98	11.84	12.99	4.62	11.60	5.71	8.06	42.98
14B	0.44	0.16	0.37	0.00	0.00	0.97	13.43	4.78	11.97	5.71	8.06	43.95
5	0.37	0.13	0.28	0.00	0.00	0.78	13.80	4.91	12.25	5.71	8.06	44.73
15A	2.06	0.73	3.16	2.48	3.24	11.67	15.86	5.64	15.41	8.19	11.30	56.40
16A	3.42	1.21	4.90	5.38	7.56	22.47	19.28	6.85	20.31	13.57	18.86	78.87
17E	11.53	4.09	13.76	18.81	27.90	76.09	30.81	10.94	34.07	32.38	46.76	154.96
17F	2.99	1.06	0.17	0.00	0.00	4.22	33.80	12.00	34.24	32.38	46.76	159.18
18A	2.68	0.95	1.65	0.00	-2.93	2.35	36.48	12.95	35.89	32.38	43.83	161.53
19	1.98	0.70	1.00	0.00	0.00	3.68	38.46	13.65	36.89	32.38	43.83	165.21
19C	2.16	0.77	0.00	0.00	0.00	2.93	40.62	14.42	36.89	32.38	43.83	168.14
20A	1.58	0.56	1.65	0.00	0.00	3.79	42.20	14.98	38.54	32.38	43.83	171.93
20B	1.91	0.68	1.09	0.00	0.00	3.68	44.11	15.66	39.63	32.38	43.83	175.61
21	0.97	0.34	0.76	0.00	0.00	2.07	45.08	16.00	40.39	32.38	43.83	177.68
22A	1.01	0.36	0.39	0.00	0.00	1.76	46.09	16.36	40.78	32.38	43.83	179.44
22B	9.89	3.51	10.65	5.83	9.20	39.08	55.98	19.87	51.43	38.21	53.03	218.52
23	2.72	0.96	0.73	0.00	-3.74	0.67	58.70	20.83	52.16	38.21	49.29	219.19
24	5.27	1.87	2.07	0.00	0.00	9.21	63.97	22.70	54.23	38.21	49.29	228.40
25	3.84	1.36	0.12	0.00	0.00	5.32	67.81	24.06	54.35	38.21	49.29	233.72
26A	4.20	1.49	6.90	0.00	-25.51	(12.92)	72.01	25.55	61.25	38.21	43.78	220.80
28G	7.82	2.77	2.61	0.00	0.00	13.20	79.83	28.32	63.86	38.21	23.78	234.00
28H	7.53	2.67	2.74	0.00	0.00	12.94	87.36	30.99	66.60	38.21	23.78	246.94
28J	84.42	29.95	38.05	0.00	0.00	152.42	171.78	60.94	104.65	38.21	23.78	399.36
<b>EBX</b>												
1	N/A	0.00	0.04	0.00	0.00	0.04	N/A	25.55	61.29	38.21	23.78	148.83
2A	N/A	0.00	0.21	4.22	0.00	4.43	N/A	25.55	61.51	42.43	23.78	153.27
2B	N/A	0.00	43.67	0.00	30.18	73.85	N/A	25.55	105.18	42.43	53.96	227.12
2C	N/A	0.00	0.34	0.00	0.00	0.34	N/A	25.55	105.52	42.43	53.96	227.46
2D	N/A	0.00	0.11	0.00	0.00	0.11	N/A	25.55	105.63	42.43	53.96	227.57
2E	N/A	0.00	0.00	0.00	0.00	0.00	N/A	25.55	105.63	42.43	53.96	227.57
3A	N/A	0.00	37.11	5.19	38.93	81.23	N/A	25.55	142.74	47.62	92.89	308.80
3B	N/A	0.00	1.50	0.00	0.00	1.50	N/A	25.55	144.24	47.62	92.89	310.30
4A	N/A	0.00	0.83	0.00	0.00	0.83	N/A	25.55	145.07	47.62	92.89	311.13
4B	N/A	0.00	10.60	1.05	8.04	19.69	N/A	25.55	155.66	48.67	100.93	330.82
<b>WB</b>												
29A	3.92	1.39	7.90	2.42	3.28	18.91	37.72	13.39	42.14	34.80	50.04	178.09
29F	2.86	1.01	0.95	0.00	0.00	4.82	40.58	14.40	43.09	34.80	50.04	182.91
29G	9.49	3.37	4.49	0.00	-11.79	5.56	50.07	17.77	47.58	34.80	38.25	188.47
29H	5.91	2.10	4.26	0.00	0.00	12.27	55.98	19.87	51.84	34.80	38.25	200.74
29J	9.91	3.52	1.22	0.00	-22.06	(7.41)	65.89	23.39	53.06	34.80	16.19	193.33
30	15.90	5.64	3.82	0.00	0.00	25.36	81.79	29.03	56.88	34.80	16.19	218.69
<b>CB</b>												
31A	7.19	2.55	18.04	1.96	2.82	32.56	14.66	5.21	24.84	5.62	7.90	58.23
33A	268.68	95.32	34.02	12.39	36.84	447.25	283.34	100.53	58.86	18.01	44.74	505.48
34	191.96	68.10	0.95	0.00	0.00	261.01	475.30	168.63	59.81	18.01	44.74	766.49
35	0.00	0.00	0.00	0.00	0.00	0.00	475.30	168.63	59.81	18.01	44.74	766.49

a) Representative of transportation unit costs only; does not include a unit cost of conservation. The Delta Water Rate should be added to these values in order to approximate unit costs at canalside.

Includes surplus water prior to May 1, 1973.

b) Hypothetical charges which, if assessed on all Table A water delivered to date, all surplus water delivered prior to May 1, 1973, and all Table A water estimated to be delivered during the remainder of the Project repayment period (Table B-5B), would provide a sum at the end of the period financially equivalent to all Transportation Charges required under the water supply contract considering interest rate at the Project Interest Rate of 4.608 percent per annum.

c) The Water System Revenue Bond Surcharge equivalent unit rate is calculated by multiplying Column 1 by the ratio of the 2009 WSRB surcharge to the sum of the Transportation Capital and the Capital component of the Delta Water Charge.

**TABLE B-26. Capital Costs of Each Aqueduct Reach to Be Reimbursed through the Capital Cost Component of the East Branch Enlargement Transportation Charge**

(in dollars)

Sheet 1 of 2

Calendar Year	CALIFORNIA AQUEDUCT							
	MOJAVE DIVISION							
	Reach 18A	Reach 19	Reach 20A	Reach 20B	Reach 21	Reach 22A	Reach 22B	Reach 23B
[1]	[2]	[3]	[4]	[5]	[6]	[7]	[8]	
1952	0	0	0	0	0	0	0	0
1953	0	0	0	0	0	0	0	0
1954	0	0	0	0	0	0	0	0
1955	0	0	0	0	0	0	0	0
1956	0	0	0	0	0	0	0	0
1957	0	0	0	0	0	0	0	0
1958	0	0	0	0	0	0	0	0
1959	0	0	0	0	0	0	0	0
1960	0	0	0	0	0	0	0	0
1961	0	0	0	0	0	0	0	0
1962	0	0	0	0	0	0	0	0
1963	0	0	0	0	0	0	0	0
1964	0	0	0	0	0	0	0	0
1965	0	0	0	0	0	0	0	0
1966	0	0	0	0	0	0	0	0
1967	0	0	0	0	0	0	0	0
1968	0	0	0	0	0	0	0	0
1969	0	0	0	0	0	0	0	0
1970	0	0	0	0	0	0	0	0
1971	0	0	0	0	0	0	0	0
1972	0	0	0	0	0	0	0	0
1973	0	0	0	0	0	0	0	0
1974	0	0	0	0	0	0	0	0
1975	0	0	0	0	0	0	0	0
1976	0	0	0	0	0	0	0	0
1977	0	0	0	0	0	0	0	0
1978	0	0	0	0	0	0	0	0
1979	117,000	0	0	0	0	0	0	0
1980	200,000	0	0	0	0	0	0	74,000
1981	135,000	0	0	0	0	0	0	385,000
1982	1,503,000	0	0	0	0	0	0	1,586,000
1983	2,260,000	0	0	0	0	0	0	2,965,000
1984	735,000	0	0	0	0	0	796,000	1,380,000
1985	93,000	435,000	75,000	544,000	859,000	703,000	970,000	146,000
1986	784,000	4,477,000	3,144,000	2,234,000	1,569,000	1,203,000	1,808,000	34,000
1987	11,000	951,000	1,076,000	666,000	399,000	47,000	16,421,000	43,000
1988	1,000	125,000	1,681,000	1,730,000	2,024,000	40,000	13,326,000	70,000
1989	0	206,000	2,089,000	2,174,000	2,510,000	61,000	11,242,000	229,000
1990	1,000	577,000	903,000	735,000	928,000	194,000	20,131,000	887,000
1991	1,000	280,000	413,000	333,000	422,000	93,000	20,702,000	1,215,000
1992	0	40,000	41,000	39,000	35,000	13,000	9,599,000	3,719,000
1993	0	19,000	16,000	19,000	12,000	6,000	2,319,000	19,654,000
1994	0	2,000	3,000	2,000	4,000	3,000	803,000	3,173,000
1995	0	0	0	0	0	0	223,000	1,465,000
1996	0	0	0	0	0	0	6,014,000	478,000
1997	0	0	0	0	0	0	404,000	1,327,000
1998	0	0	0	0	0	0	0	0
1999	0	0	0	0	0	0	0	0
2000	0	0	0	0	0	0	0	0
<b>TOTAL</b>	<b>5,841,000</b>	<b>7,112,000</b>	<b>9,441,000</b>	<b>8,476,000</b>	<b>8,762,000</b>	<b>2,363,000</b>	<b>104,758,000</b>	<b>38,830,000</b>

**TABLE B-26. Capital Costs of Each Aqueduct Reach  
to Be Reimbursed through the Capital Cost Component  
of the East Branch Enlargement Transportation Charge**

(in dollars)

Sheet 2 of 2

Calendar Year	CALIFORNIA AQUEDUCT (continued)							GRAND TOTAL
	MOJAVE DIVISION (continued)			SANTA ANA DIVISION				
	Reach 23C	Reach 24	Total	Reach 25	Reach 26A	Reach 26B	Total	
[9]	[10]	[11]	[12]	[13]	[14]	[15]	[16]	
1952	0	0	0	0	0	0	0	0
1953	0	0	0	0	0	0	0	0
1954	0	0	0	0	0	0	0	0
1955	0	0	0	0	0	0	0	0
1956	0	0	0	0	0	0	0	0
1957	0	0	0	0	0	0	0	0
1958	0	0	0	0	0	0	0	0
1959	0	0	0	0	0	0	0	0
1960	0	0	0	0	0	0	0	0
1961	0	0	0	0	0	0	0	0
1962	0	0	0	0	0	0	0	0
1963	0	0	0	0	0	0	0	0
1964	0	0	0	0	0	0	0	0
1965	0	0	0	0	0	0	0	0
1966	0	0	0	0	0	0	0	0
1967	0	0	0	0	0	0	0	0
1968	0	0	0	0	0	0	0	0
1969	0	0	0	0	0	0	0	0
1970	0	0	0	0	0	0	0	0
1971	0	0	0	0	0	0	0	0
1972	0	0	0	0	0	0	0	0
1973	0	0	0	0	0	0	0	0
1974	0	0	0	0	0	0	0	0
1975	0	0	0	0	0	0	0	0
1976	0	0	0	0	0	0	0	0
1977	0	0	0	0	0	0	0	0
1978	0	0	0	0	0	0	0	0
1979	0	0	117,000	0	0	0	0	117,000
1980	0	0	274,000	0	0	0	0	274,000
1981	0	0	520,000	0	0	0	0	520,000
1982	0	0	3,089,000	0	0	0	0	3,089,000
1983	0	0	5,225,000	0	0	0	0	5,225,000
1984	0	0	2,911,000	0	0	0	0	2,911,000
1985	0	0	3,825,000	0	528,000	89,000	617,000	4,442,000
1986	25,000	0	15,278,000	0	1,926,000	154,000	2,080,000	17,358,000
1987	178,000	0	19,792,000	0	3,699,000	437,000	4,136,000	23,928,000
1988	632,000	0	19,629,000	0	5,667,000	3,329,000	8,996,000	28,625,000
1989	1,130,000	0	19,641,000	0	40,879,000	1,650,000	42,529,000	62,170,000
1990	2,066,000	0	26,422,000	0	29,853,000	1,650,000	31,503,000	57,925,000
1991	4,980,000	0	28,439,000	0	26,027,000	999,000	27,026,000	55,465,000
1992	11,920,000	0	25,406,000	0	15,317,000	299,000	15,616,000	41,022,000
1993	16,303,000	0	38,348,000	0	4,878,000	0	4,878,000	43,226,000
1994	7,081,000	0	11,071,000	0	3,151,000	0	3,151,000	14,222,000
1995	5,350,000	0	7,038,000	0	2,137,000	0	2,137,000	9,175,000
1996	1,706,000	0	8,198,000	0	9,181,000	0	9,181,000	17,379,000
1997	1,905,000	0	3,636,000	0	175,000	0	175,000	3,811,000
1998	28,000	0	28,000	0	0	0	0	28,000
1999	0	0	0	0	0	0	0	0
2000	0	0	0	0	0	0	0	0
<b>TOTAL</b>	<b>53,304,000</b>	<b>0</b>	<b>238,887,000</b>	<b>0</b>	<b>143,418,000</b>	<b>8,607,000</b>	<b>152,025,000</b>	<b>390,912,000</b>

**TABLE B-27. Minimum OMP&R Costs of Each Aqueduct Reach to Be Reimbursed through Minimum OMP&R Component of the East Branch Enlargement Transportation Charge**

(in dollars)

Sheet 1 of 2

Calendar Year	CALIFORNIA AQUEDUCT							
	MOJAVE DIVISION							
	Reach 18A	Reach 19	Reach 20A	Reach 20B	Reach 21	Reach 22A	Reach 22B	Reach 23B
[1]	[2]	[3]	[4]	[5]	[6]	[7]	[8]	
1971	0	0	0	0	0	0	0	0
1972	0	0	0	0	0	0	0	0
1973	0	0	0	0	0	0	0	0
1974	0	0	0	0	0	0	0	0
1975	0	0	0	0	0	0	0	0
1976	0	0	0	0	0	0	0	0
1977	0	0	0	0	0	0	0	0
1978	0	0	0	0	0	0	0	0
1979	0	0	0	0	0	0	0	0
1980	0	0	0	0	0	0	0	0
1981	0	0	0	0	0	0	0	0
1982	0	0	0	0	0	0	0	0
1983	0	0	0	0	0	0	0	0
1984	0	0	0	0	0	0	0	0
1985	0	0	0	0	0	0	0	0
1986	0	0	0	0	0	0	0	0
1987	0	0	0	0	0	0	0	0
1988	0	0	0	0	0	0	0	0
1989	0	0	0	0	0	0	0	0
1990	0	0	0	0	0	0	0	0
1991	0	0	0	0	0	0	0	0
1992	0	0	0	0	0	0	0	0
1993	0	0	0	0	0	0	0	0
1994	0	0	0	0	0	0	1,048,625	0
1995	0	0	0	0	0	0	953,814	0
1996	0	0	0	0	0	0	1,171,411	0
1997	0	0	0	0	0	0	1,110,038	0
1998	0	0	0	0	0	0	1,213,002	0
1999	1,229	517	646	409	383	169	668,466	0
2000	4,452	1,875	2,340	1,484	1,386	614	1,315,920	0
2001	347	146	183	116	108	48	1,045,627	0
2002	1,639	690	861	546	510	226	1,539,859	0
2003	0	0	0	0	0	0	1,813,951	0
2004	2,132	27,868	18,579	18,731	10,355	8,528	1,485,104	0
2005	1,243	16,250	10,833	10,922	6,038	4,973	1,046,391	0
2006	4,629	60,508	40,339	40,669	22,484	18,516	1,724,957	0
2007	13,120	171,503	114,335	115,273	63,728	52,482	2,012,220	0
2008	0	0	0	0	0	0	1,849,286	0
2009	0	0	0	0	0	0	2,033,862	0
2010	0	0	0	0	0	0	2,095,051	0
2011	0	0	0	0	0	0	2,095,051	0
2012	0	0	0	0	0	0	2,095,051	0
2013	0	0	0	0	0	0	2,095,051	0
2014	0	0	0	0	0	0	2,095,051	0
2015	0	0	0	0	0	0	2,095,051	0
2016	0	0	0	0	0	0	2,095,051	0
2017	0	0	0	0	0	0	2,095,051	0
2018	0	0	0	0	0	0	2,095,051	0
2019	0	0	0	0	0	0	2,095,051	0
2020	0	0	0	0	0	0	2,095,051	0
2021	0	0	0	0	0	0	2,095,051	0
2022	0	0	0	0	0	0	2,095,051	0
2023	0	0	0	0	0	0	2,095,051	0
2024	0	0	0	0	0	0	2,095,051	0
2025	0	0	0	0	0	0	2,095,051	0
2026	0	0	0	0	0	0	2,095,051	0
2027	0	0	0	0	0	0	2,095,051	0
2028	0	0	0	0	0	0	2,095,051	0
2029	0	0	0	0	0	0	2,095,051	0
2030	0	0	0	0	0	0	2,095,051	0
2031	0	0	0	0	0	0	2,095,051	0
2032	0	0	0	0	0	0	2,095,051	0
2033	0	0	0	0	0	0	2,095,051	0
2034	0	0	0	0	0	0	2,095,051	0
2035	0	0	0	0	0	0	2,095,051	0
TOTAL	28,791	279,357	188,116	188,150	104,992	85,556	76,503,859	0

**TABLE B-27. Minimum OMP&R Costs of Each Aqueduct Reach to Be Reimbursed through Minimum OMP&R Component of the East Branch Enlargement Transportation Charge**

(in dollars)

Sheet 2 of 2

Calendar Year	CALIFORNIA AQUEDUCT (continued)							TOTAL
	MOJAVE DIVISION (continued)			SANTA ANA DIVISION				
	Reach 23C	Reach 24	Subtotal	Reach 25	Reach 26A (a)	Reach 26B	Subtotal	
[9]	[10]	[11]	[12]	[13]	[14]	[15]	[16]	
1971	0	0	0	0	0	0	0	0
1972	0	0	0	0	0	0	0	0
1973	0	0	0	0	0	0	0	0
1974	0	0	0	0	0	0	0	0
1975	0	0	0	0	0	0	0	0
1976	0	0	0	0	0	0	0	0
1977	0	0	0	0	0	0	0	0
1978	0	0	0	0	0	0	0	0
1979	0	0	0	0	0	0	0	0
1980	0	0	0	0	0	0	0	0
1981	0	0	0	0	0	0	0	0
1982	0	0	0	0	0	0	0	0
1983	0	0	0	0	0	0	0	0
1984	0	0	0	0	0	0	0	0
1985	0	0	0	0	0	0	0	0
1986	0	0	0	0	0	0	0	0
1987	0	0	0	0	0	0	0	0
1988	0	0	0	0	0	0	0	0
1989	0	0	0	0	0	0	0	0
1990	0	0	0	0	0	0	0	0
1991	0	0	0	0	0	0	0	0
1992	0	0	0	0	0	0	0	0
1993	0	0	0	0	0	0	0	0
1994	0	0	1,048,625	0	1,713,260	0	1,713,260	2,761,885
1995	0	0	953,814	0	1,452,549	0	1,452,549	2,406,363
1996	0	0	1,171,411	0	1,350,581	0	1,350,581	2,521,992
1997	679,826	0	1,789,864	0	1,528,509	0	1,528,509	3,318,373
1998	825,038	0	2,038,040	0	1,619,068	0	1,619,068	3,657,108
1999	382,178	0	1,053,997	0	956,229	0	956,229	2,010,226
2000	735,803	0	2,063,874	0	1,409,109	0	1,409,109	3,472,983
2001	812,634	0	1,859,209	0	811,400	0	811,400	2,670,609
2002	727,751	0	2,272,082	0	1,143,205	0	1,143,205	3,415,287
2003	899,739	0	2,713,690	0	1,248,051	0	1,248,051	3,961,741
2004	913,701	0	2,484,998	0	1,815,458	0	1,815,458	4,300,456
2005	1,036,778	0	2,133,428	0	1,863,002	0	1,863,002	3,996,430
2006	827,315	0	2,739,417	0	1,871,748	0	1,871,748	4,611,165
2007	1,366,626	0	3,909,287	0	2,628,721	0	2,628,721	6,538,008
2008	1,158,641	0	3,007,927	0	2,428,184	0	2,428,184	5,436,111
2009	1,213,983	0	3,247,845	0	2,868,402	0	2,868,402	6,116,247
2010	1,267,105	0	3,362,156	0	2,905,697	0	2,905,697	6,267,853
2011	1,267,105	0	3,362,156	0	2,905,697	0	2,905,697	6,267,853
2012	1,267,105	0	3,362,156	0	2,905,697	0	2,905,697	6,267,853
2013	1,267,105	0	3,362,156	0	2,905,697	0	2,905,697	6,267,853
2014	1,267,105	0	3,362,156	0	2,905,697	0	2,905,697	6,267,853
2015	1,267,105	0	3,362,156	0	2,905,697	0	2,905,697	6,267,853
2016	1,267,105	0	3,362,156	0	2,905,697	0	2,905,697	6,267,853
2017	1,267,105	0	3,362,156	0	2,905,697	0	2,905,697	6,267,853
2018	1,267,105	0	3,362,156	0	2,905,697	0	2,905,697	6,267,853
2019	1,267,105	0	3,362,156	0	2,905,697	0	2,905,697	6,267,853
2020	1,267,105	0	3,362,156	0	2,905,697	0	2,905,697	6,267,853
2021	1,267,105	0	3,362,156	0	2,905,697	0	2,905,697	6,267,853
2022	1,267,105	0	3,362,156	0	2,905,697	0	2,905,697	6,267,853
2023	1,267,105	0	3,362,156	0	2,905,697	0	2,905,697	6,267,853
2024	1,267,105	0	3,362,156	0	2,905,697	0	2,905,697	6,267,853
2025	1,267,105	0	3,362,156	0	2,905,697	0	2,905,697	6,267,853
2026	1,267,105	0	3,362,156	0	2,905,697	0	2,905,697	6,267,853
2027	1,267,105	0	3,362,156	0	2,905,697	0	2,905,697	6,267,853
2028	1,267,105	0	3,362,156	0	2,905,697	0	2,905,697	6,267,853
2029	1,267,105	0	3,362,156	0	2,905,697	0	2,905,697	6,267,853
2030	1,267,105	0	3,362,156	0	2,905,697	0	2,905,697	6,267,853
2031	1,267,105	0	3,362,156	0	2,905,697	0	2,905,697	6,267,853
2032	1,267,105	0	3,362,156	0	2,905,697	0	2,905,697	6,267,853
2033	1,267,105	0	3,362,156	0	2,905,697	0	2,905,697	6,267,853
2034	1,267,105	0	3,362,156	0	2,905,697	0	2,905,697	6,267,853
2035	1,267,105	0	3,362,156	0	2,905,697	0	2,905,697	6,267,853
TOTAL	44,524,743	0	121,903,564	0	102,255,601	0	102,255,601	224,159,165

a) Units 3 and 4 at Devil Canyon Powerplant were operational in 1993.

**TABLE B-28. Capital Costs of East Branch Enlargement  
Transportation Facilities Allocated to Each Contractor**

(in dollars)

Calendar Year	SOUTHERN CALIFORNIA AREA							Total
	Antelope Valley- East Kern Water Agency	Coachella Valley Water District	Desert Water Agency	Mojave Water Agency	Palmdale Water District	San Bernardino Valley Municipal Water District	The Metropolitan Water District of Southern California	
	[1]	[2]	[3]	[4]	[5]	[6]	[7]	[8]
1971	0	0	0	0	0	0	0	0
1972	0	0	0	0	0	0	0	0
1973	0	0	0	0	0	0	0	0
1974	0	0	0	0	0	0	0	0
1975	0	0	0	0	0	0	0	0
1976	0	0	0	0	0	0	0	0
1977	0	0	0	0	0	0	0	0
1978	0	0	0	0	0	0	0	0
1979	0	11,731	1,010	10,566	466	0	93,227	117,000
1980	0	28,241	4,708	27,495	797	0	212,759	274,000
1981	0	56,134	16,676	61,271	538	0	385,381	520,000
1982	0	326,180	76,872	337,913	5,988	0	2,342,047	3,089,000
1983	0	554,658	138,964	582,070	9,004	0	3,940,304	5,225,000
1984	0	306,514	68,842	314,468	2,928	0	2,218,248	2,911,000
1985	49,675	447,266	65,773	347,262	4,514	21,614	3,505,896	4,442,000
1986	185,353	1,757,633	236,324	1,363,586	41,900	78,842	13,694,362	17,358,000
1987	49,735	2,455,279	378,535	1,774,447	10,615	151,421	19,107,968	23,928,000
1988	124,534	2,689,959	500,466	1,712,431	13,783	231,982	23,351,845	28,625,000
1989	155,446	7,118,094	2,423,000	1,671,088	17,419	1,673,409	49,111,544	62,170,000
1990	62,786	6,459,229	1,943,918	2,234,452	8,680	1,222,053	45,993,882	57,925,000
1991	28,686	6,265,822	1,875,066	2,168,712	4,024	1,065,433	44,057,257	55,465,000
1992	2,911	4,826,764	1,610,921	1,359,335	471	627,012	32,594,586	41,022,000
1993	1,205	5,094,237	1,828,410	2,722,156	212	199,684	33,380,096	43,226,000
1994	273	1,726,376	631,816	478,543	27	128,988	11,255,977	14,222,000
1995	0	1,130,963	423,243	206,978	0	87,480	7,326,336	9,175,000
1996	0	2,025,987	645,296	606,205	0	375,830	13,725,682	17,379,000
1997	0	451,011	154,366	205,796	0	7,164	2,992,663	3,811,000
1998	0	3,551	1,293	0	0	0	23,156	28,000
1999	0	0	0	0	0	0	0	0
2000	0	0	0	0	0	0	0	0
TOTAL	660,604	43,735,629	13,025,499	18,184,774	121,366	5,870,912	309,313,216	390,912,000

**TABLE B-29. Capital Cost Component of East Branch Enlargement Facilities Transportation Charge for Each Contractor**

(in dollars)

Calendar Year	SOUTHERN CALIFORNIA AREA							Total
	Antelope Valley - East Kern Water Agency	Coachella Valley Water District	Desert Water Agency	Mojave Water Agency	Palmdale Water District	San Bernardino Valley Municipal Water District (a)	The Metropolitan Water District of Southern California	
	[1]	[2]	[3]	[4]	[5]	[6]	[7]	[8]
1971	0	0	0	0	0	0	0	0
1972	0	0	0	0	0	0	0	0
1973	0	0	0	0	0	0	0	0
1974	0	0	0	0	0	0	0	0
1975	0	0	0	0	0	0	0	0
1976	0	0	0	0	0	0	0	0
1977	0	0	0	0	0	0	0	0
1978	0	0	0	0	0	0	0	0
1979	0	0	0	0	0	0	0	0
1980	0	0	0	0	0	0	0	0
1981	0	0	0	0	0	0	0	0
1982	0	0	0	0	0	0	0	0
1983	0	0	0	0	0	0	0	0
1984	0	0	0	0	0	0	0	0
1985	0	0	0	0	0	0	0	0
1986	0	0	0	0	0	0	0	0
1987	0	0	0	0	0	0	0	0
1988	18,266	1,209,293	360,156	502,810	3,356	0	8,552,529	10,646,410
1989	19,176	1,269,524	378,094	527,854	3,523	0	8,978,504	11,176,675
1990	19,186	1,270,244	378,308	528,153	3,525	0	8,983,597	11,183,013
1991	19,187	1,270,261	378,314	528,160	3,525	0	8,983,717	11,183,164
1992	38,420	2,543,616	757,549	1,057,606	7,059	0	17,989,315	22,393,565
1993	40,029	2,650,139	789,274	1,101,897	7,354	0	18,742,682	23,331,375
1994	39,705	2,628,706	782,890	1,092,986	7,295	0	18,591,099	23,142,681
1995	39,632	2,623,828	781,438	1,090,958	7,281	0	18,556,603	23,099,740
1996	39,825	2,636,667	785,261	1,096,296	7,317	0	18,647,406	23,212,772
1997	41,743	2,763,629	823,074	1,149,085	7,669	0	19,545,322	24,330,522
1998	42,642	2,823,126	840,793	1,173,823	7,834	0	19,966,108	24,854,326
1999	44,738	2,961,887	882,120	1,231,519	8,219	0	20,947,475	26,075,958
2000	49,031	3,246,109	966,768	1,349,695	9,008	0	22,957,586	28,578,197
2001	49,048	3,247,263	967,111	1,350,175	9,011	0	22,965,748	28,588,356
2002	47,894	3,170,848	944,353	1,318,402	8,799	0	22,425,319	27,915,615
2003	40,711	2,695,262	802,713	1,120,659	7,479	0	19,061,812	23,728,636
2004	44,352	2,936,320	874,505	1,220,888	8,148	0	20,766,652	25,850,865
2005	32,790	2,170,883	646,540	902,628	6,024	0	15,353,227	19,112,092
2006	47,064	3,115,874	927,980	1,295,545	8,647	0	22,036,516	27,431,626
2007	45,335	3,001,432	893,897	1,247,961	8,329	0	21,227,145	26,424,099
2008	63,563	4,292,843	1,289,700	1,749,726	11,678	0	30,288,105	37,695,615
2009	65,062	4,400,605	1,322,926	1,790,974	11,953	0	31,042,926	38,634,446
2010	64,751	4,368,248	1,311,729	1,782,426	11,896	0	30,824,165	38,363,215
2011	66,373	4,493,956	1,351,588	1,827,084	12,195	0	31,697,562	39,448,758
2012	66,477	4,501,097	1,353,745	1,829,959	12,214	0	31,747,883	39,511,375
2013	65,782	4,445,918	1,336,098	1,810,833	12,086	0	31,365,493	39,036,210
2014	66,255	4,465,953	1,340,586	1,823,812	12,172	0	31,516,732	39,225,510
2015	67,997	4,584,371	1,376,254	1,871,791	12,493	0	32,351,650	40,264,556
2016	68,184	4,596,752	1,379,948	1,876,918	12,527	0	32,439,162	40,373,491
2017	69,918	4,709,272	1,413,155	1,924,657	12,845	0	33,236,915	41,366,762
2018	68,375	4,597,514	1,378,605	1,882,171	12,562	0	32,454,702	40,393,929
2019	70,260	4,730,131	1,419,127	1,934,088	12,908	0	33,385,981	41,552,495
2020	67,268	4,530,416	1,359,436	1,851,713	12,358	0	31,974,900	39,796,091
2021	68,757	4,635,301	1,391,510	1,892,690	12,632	0	32,711,268	40,712,158
2022	68,021	4,595,620	1,380,887	1,872,435	12,497	0	32,422,911	40,352,371
2023	56,501	3,833,688	1,154,059	1,555,336	10,381	0	27,033,659	33,643,624
2024	58,474	3,965,026	1,193,268	1,609,651	10,743	0	27,961,917	34,799,079
2025	66,925	4,524,020	1,359,688	1,842,270	12,296	0	31,915,717	39,720,916
2026	24,555	1,703,468	517,616	675,948	4,511	0	11,981,032	14,907,130
2027	25,018	1,730,989	525,400	688,686	4,596	0	12,178,340	15,153,029
2028	16,326	1,120,244	338,841	449,412	3,000	0	7,889,091	9,816,914
2029	17,026	1,166,423	352,574	468,679	3,128	0	8,215,818	10,223,648
2030	0	0	0	0	0	0	0	0
2031	0	0	0	0	0	0	0	0
2032	0	0	0	0	0	0	0	0
2033	0	0	0	0	0	0	0	0
2034	0	0	0	0	0	0	0	0
2035	0	0	0	0	0	0	0	0
<b>TOTAL</b>	<b>2,030,642</b>	<b>136,226,766</b>	<b>40,807,878</b>	<b>55,898,359</b>	<b>373,073</b>	<b>0</b>	<b>961,914,291</b>	<b>1,197,251,009</b>

a) Under Article 49(d)(4)(A) of its contract, San Bernardino Valley Municipal Water District elected to pay a portion of its allocated costs of East Branch Enlargement in advance rather than to participate in payment of Water System Revenue Bonds. This election made via a letter of agreement signed June 1, 1987. As of June 1999, \$6,347,938 has been received from the San Bernardino Valley Municipal Water District.

**TABLE B-30. Minimum OMP&R Component of East Branch Enlargement Facilities Transportation Charge for Each Contractor**

(in dollars)

Calendar Year	SOUTHERN CALIFORNIA AREA							Total
	Antelope Valley-East Kern Water Agency	Coachella Valley Water District	Desert Water Agency	Mojave Water Agency	Palmdale Water District	San Bernardino Valley Municipal Water District	The Metropolitan Water District of Southern California	
	[1]	[2]	[3]	[4]	[5]	[6]	[7]	[8]
1971	0	0	0	0	0	0	0	0
1972	0	0	0	0	0	0	0	0
1973	0	0	0	0	0	0	0	0
1974	0	0	0	0	0	0	0	0
1975	0	0	0	0	0	0	0	0
1976	0	0	0	0	0	0	0	0
1977	0	0	0	0	0	0	0	0
1978	0	0	0	0	0	0	0	0
1979	0	0	0	0	0	0	0	0
1980	0	0	0	0	0	0	0	0
1981	0	0	0	0	0	0	0	0
1982	0	0	0	0	0	0	0	0
1983	0	0	0	0	0	0	0	0
1984	0	0	0	0	0	0	0	0
1985	0	0	0	0	0	0	0	0
1986	0	0	0	0	0	0	0	0
1987	0	0	0	0	0	0	0	0
1988	0	0	0	0	0	0	0	0
1989	0	0	0	0	0	0	0	0
1990	0	0	0	0	0	0	0	0
1991	0	0	0	0	0	0	0	0
1992	0	0	0	0	0	0	0	0
1993	0	0	0	0	0	0	0	0
1994	0	320,415	101,486	95,075	0	70,133	2,174,776	2,761,885
1995	0	278,176	86,604	86,479	0	59,461	1,895,643	2,406,363
1996	0	287,293	82,991	106,208	0	55,287	1,990,213	2,521,992
1997	0	389,636	123,446	100,643	0	62,571	2,642,077	3,318,373
1998	0	429,772	135,927	109,979	0	66,278	2,915,152	3,657,108
1999	37	236,006	75,040	60,907	11	39,144	1,599,081	2,010,226
2000	132	403,693	121,479	120,396	40	57,683	2,769,560	3,472,983
2001	10	310,158	90,353	94,888	3	33,215	2,141,982	2,670,609
2002	49	391,107	108,642	140,014	15	46,798	2,728,662	3,415,287
2003	0	453,213	124,575	164,465	0	51,090	3,168,398	3,961,741
2004	1,278	501,557	153,704	142,324	265	74,317	3,427,011	4,300,456
2005	745	475,410	157,844	99,348	154	76,263	3,186,666	3,996,430
2006	2,775	531,787	155,689	173,060	575	76,621	3,670,658	4,611,165
2007	7,865	757,964	226,828	229,674	1,630	107,608	5,206,439	6,538,008
2008	0	637,597	200,482	167,669	0	99,399	4,330,964	5,436,111
2009	0	718,401	228,379	184,403	0	117,420	4,867,644	6,116,247
2010	0	735,974	233,373	189,951	0	118,947	4,989,608	6,267,853
2011	0	735,974	233,373	189,951	0	118,947	4,989,608	6,267,853
2012	0	735,974	233,373	189,951	0	118,947	4,989,608	6,267,853
2013	0	735,974	233,373	189,951	0	118,947	4,989,608	6,267,853
2014	0	735,974	233,373	189,951	0	118,947	4,989,608	6,267,853
2015	0	735,974	233,373	189,951	0	118,947	4,989,608	6,267,853
2016	0	735,974	233,373	189,951	0	118,947	4,989,608	6,267,853
2017	0	735,974	233,373	189,951	0	118,947	4,989,608	6,267,853
2018	0	735,974	233,373	189,951	0	118,947	4,989,608	6,267,853
2019	0	735,974	233,373	189,951	0	118,947	4,989,608	6,267,853
2020	0	735,974	233,373	189,951	0	118,947	4,989,608	6,267,853
2021	0	735,974	233,373	189,951	0	118,947	4,989,608	6,267,853
2022	0	735,974	233,373	189,951	0	118,947	4,989,608	6,267,853
2023	0	735,974	233,373	189,951	0	118,947	4,989,608	6,267,853
2024	0	735,974	233,373	189,951	0	118,947	4,989,608	6,267,853
2025	0	735,974	233,373	189,951	0	118,947	4,989,608	6,267,853
2026	0	735,974	233,373	189,951	0	118,947	4,989,608	6,267,853
2027	0	735,974	233,373	189,951	0	118,947	4,989,608	6,267,853
2028	0	735,974	233,373	189,951	0	118,947	4,989,608	6,267,853
2029	0	735,974	233,373	189,951	0	118,947	4,989,608	6,267,853
2030	0	735,974	233,373	189,951	0	118,947	4,989,608	6,267,853
2031	0	735,974	233,373	189,951	0	118,947	4,989,608	6,267,853
2032	0	735,974	233,373	189,951	0	118,947	4,989,608	6,267,853
2033	0	735,974	233,373	189,951	0	118,947	4,989,608	6,267,853
2034	0	735,974	233,373	189,951	0	118,947	4,989,608	6,267,853
2035	0	735,974	233,373	189,951	0	118,947	4,989,608	6,267,853
TOTAL	12,891	26,257,509	8,241,167	7,014,258	2,693	4,185,910	178,444,734	224,159,162



**TABLE B-31. Total East Branch Enlargement Facilities  
Transportation Charge for Each Contractor**

(in dollars)

Calendar Year	SOUTHERN CALIFORNIA AREA							Total
	Antelope Valley- East Kern Water Agency	Coachella Valley Water District	Desert Water Agency	Mojave Water Agency	Palmdale Water District	San Bernardino Valley Municipal Water District	The Metropolitan Water District of Southern California	
	[1]	[2]	[3]	[4]	[5]	[6]	[7]	[8]
1971	0	0	0	0	0	0	0	0
1972	0	0	0	0	0	0	0	0
1973	0	0	0	0	0	0	0	0
1974	0	0	0	0	0	0	0	0
1975	0	0	0	0	0	0	0	0
1976	0	0	0	0	0	0	0	0
1977	0	0	0	0	0	0	0	0
1978	0	0	0	0	0	0	0	0
1979	0	0	0	0	0	0	0	0
1980	0	0	0	0	0	0	0	0
1981	0	0	0	0	0	0	0	0
1982	0	0	0	0	0	0	0	0
1983	0	0	0	0	0	0	0	0
1984	0	0	0	0	0	0	0	0
1985	0	0	0	0	0	0	0	0
1986	0	0	0	0	0	0	0	0
1987	0	0	0	0	0	0	0	0
1988	18,266	1,209,293	360,156	502,810	3,356	0	8,552,529	10,646,410
1989	19,176	1,269,524	378,094	527,854	3,523	0	8,978,504	11,176,675
1990	19,186	1,270,244	378,308	528,153	3,525	0	8,983,597	11,183,013
1991	19,187	1,270,261	378,314	528,160	3,525	0	8,983,717	11,183,164
1992	38,420	2,543,616	757,549	1,057,606	7,059	0	17,989,315	22,393,565
1993	40,029	2,650,139	789,274	1,101,897	7,354	0	18,742,682	23,331,375
1994	39,705	2,949,121	884,376	1,188,061	7,295	70,133	20,765,875	25,904,566
1995	39,632	2,902,004	868,042	1,177,437	7,281	59,461	20,452,246	25,506,103
1996	39,825	2,923,960	868,252	1,202,504	7,317	55,287	20,637,619	25,734,764
1997	41,743	3,153,265	946,520	1,249,728	7,669	62,571	22,187,399	27,648,895
1998	42,642	3,252,898	976,720	1,283,802	7,834	66,278	22,881,260	28,511,434
1999	44,775	3,197,893	957,160	1,292,426	8,230	39,144	22,546,556	28,086,184
2000	49,163	3,649,802	1,088,247	1,470,091	9,048	57,683	25,727,146	32,051,180
2001	49,058	3,557,421	1,057,464	1,445,063	9,014	33,215	25,107,730	31,258,965
2002	47,943	3,561,955	1,052,995	1,458,416	8,814	46,798	25,153,981	31,330,902
2003	40,711	3,148,475	927,288	1,285,124	7,479	51,090	22,230,210	27,690,377
2004	45,630	3,437,877	1,028,209	1,363,212	8,413	74,317	24,193,663	30,151,321
2005	33,535	2,646,293	804,384	1,001,976	6,178	76,263	18,539,893	23,108,522
2006	49,839	3,647,661	1,083,669	1,468,605	9,222	76,621	25,707,174	32,042,791
2007	53,200	3,759,396	1,120,725	1,477,635	9,959	107,608	26,433,584	32,962,107
2008	63,563	4,930,440	1,490,182	1,917,395	11,678	99,399	34,619,069	43,131,726
2009	65,062	5,119,006	1,551,305	1,975,377	11,953	117,420	35,910,570	44,750,693
2010	64,751	5,104,222	1,545,102	1,972,377	11,896	118,947	35,813,773	44,631,068
2011	66,373	5,229,930	1,584,961	2,017,035	12,195	118,947	36,687,170	45,716,611
2012	66,477	5,237,071	1,587,118	2,019,910	12,214	118,947	36,737,491	45,779,228
2013	65,782	5,181,892	1,569,471	2,000,784	12,086	118,947	36,355,101	45,304,063
2014	66,255	5,201,927	1,573,959	2,013,763	12,172	118,947	36,506,340	45,493,363
2015	67,997	5,320,345	1,609,627	2,061,742	12,493	118,947	37,341,258	46,532,409
2016	68,184	5,332,726	1,613,321	2,066,869	12,527	118,947	37,428,770	46,641,344
2017	69,918	5,445,246	1,646,528	2,114,608	12,845	118,947	38,226,523	47,634,615
2018	68,375	5,333,488	1,611,978	2,072,122	12,562	118,947	37,444,310	46,661,782
2019	70,260	5,466,105	1,652,500	2,124,039	12,908	118,947	38,375,589	47,820,348
2020	67,268	5,266,390	1,592,809	2,041,664	12,358	118,947	36,964,508	46,063,944
2021	68,757	5,371,275	1,624,883	2,082,641	12,632	118,947	37,700,876	46,980,011
2022	68,021	5,331,594	1,614,260	2,062,386	12,497	118,947	37,412,519	46,620,224
2023	56,501	4,569,662	1,387,432	1,745,287	10,381	118,947	32,023,267	39,911,477
2024	58,474	4,701,000	1,426,641	1,799,602	10,743	118,947	32,951,525	41,066,932
2025	66,925	5,259,994	1,593,061	2,032,221	12,296	118,947	36,905,325	45,988,769
2026	24,555	2,439,442	750,989	865,899	4,511	118,947	16,970,640	21,174,983
2027	25,018	2,466,963	758,773	878,637	4,596	118,947	17,167,948	21,420,882
2028	16,326	1,856,218	572,214	639,363	3,000	118,947	12,878,699	16,084,767
2029	17,026	1,902,397	585,947	658,630	3,128	118,947	13,205,426	16,491,501
2030	0	735,974	233,373	189,951	0	118,947	4,989,608	6,267,853
2031	0	735,974	233,373	189,951	0	118,947	4,989,608	6,267,853
2032	0	735,974	233,373	189,951	0	118,947	4,989,608	6,267,853
2033	0	735,974	233,373	189,951	0	118,947	4,989,608	6,267,853
2034	0	735,974	233,373	189,951	0	118,947	4,989,608	6,267,853
2035	0	735,974	233,373	189,951	0	118,947	4,989,608	6,267,853
<b>TOTAL</b>	<b>2,043,533</b>	<b>162,484,275</b>	<b>49,049,045</b>	<b>62,912,617</b>	<b>375,766</b>	<b>4,185,910</b>	<b>1,140,359,025</b>	<b>1,421,410,171</b>

## CONVERSION FACTORS

Quantity	To convert from customary unit	To metric units	Multiply customary unit by	To convert to customary unit, multiply metric unit by
Length	inches (in)	millimeters (mm)●	25.4	0.03937
	inches (in)	centimeters (cm)	2.54	0.3937
	feet (ft)	meters (m)	0.3048	3.2808
	miles (mi)	kilometers (km)	1.6093	0.62139
Area	square inches (in <sup>2</sup> )	square millimeters (mm <sup>2</sup> )	645.16	0.00155
	square feet (ft <sup>2</sup> )	square meters (m <sup>2</sup> )	0.092903	10.764
	acres (ac)	hectares (ha)	0.40469	2.4710
	square miles (mi <sup>2</sup> )	square kilometers (km <sup>2</sup> )	2.590	0.3861
Volume	gallons (gal)	liters (L)	3.7854	0.26417
	million gallons (106 gal)	megaliters (ML)	3.7854	0.26417
	cubic feet (ft <sup>3</sup> )	cubic meters (m <sup>3</sup> )	0.028317	35.315
	cubic yards (yd <sup>3</sup> )	cubic meters (m <sup>3</sup> )	0.76455	1.308
	acre-feet (af)	thousand cubic meters (m <sup>3</sup> x 10 <sup>3</sup> )	1.2335	0.8107
	acre-feet (af)	hectare-meters (ha - m)■	0.1234	8.107
	thousand acre-feet (taf)	million cubic meters (m <sup>3</sup> x 106)	1.2335	0.8107
	thousand acre-feet (taf)	hectare-meters (ha - m)■	123.35	0.008107
	million acre-feet (maf)	billion cubic meters (m <sup>3</sup> x 109)◆	1.2335	0.8107
	million acre-feet (maf)	cubic kilometers (km <sup>3</sup> )	1.2335	0.8107
Flow	cubic feet per second (ft <sup>3</sup> /s)	cubic meters per second (m <sup>3</sup> /s)	0.028317	35.315
	gallons per minute (gal/min)	liters per minute (L/min)	3.7854	0.26417
	gallons per day (gal/day)	liters per day (L/day)	3.7854	0.26417
	million gallons per day (mgd)	megaliters per day (ML/day)	3.7854	0.26417
	acre-feet per day (af/day)	thousand cubic meters per day (m <sup>3</sup> x 10 <sup>3</sup> /day)	1.2335	0.8107
Mass	pounds (lb)	kilograms (kg)	0.45359	2.2046
	tons (short, 2,000 lb)	megagrams (Mg)	0.90718	1.1023
Velocity	feet per second (ft/s)	meters per second (m/s)	0.3048	3.2808
Power	horsepower (hp)	kilowatts (kW)	0.746	1.3405
Pressure	pounds per square inch (psi)	kilopascals (kPa)	6.8948	0.14505
	feet head of water	kilopascals (kPa)	2.989	0.32456
Specific capacity	gallons per minute per foot of drawdown	liters per minute per meter of drawdown	12.419	0.08052
Concentration	parts per million (ppm)	milligrams per liter (mg/L)	1.0	1.0
Electrical conductivity	micromhos per centimeter (μmhos/cm)	microsiemens per centimeter (μS/cm)	1.0	1.0
Temperature	degrees Fahrenheit (°F)	degrees Celsius (°C)	(°F - 32)/1.8	(1.8 x °C) + 32

● When using "dual units," inches are normally converted to millimeters (rather than centimeters).

■ Not used often in metric countries, but is offered as a conceptual equivalent of customary western U.S. practice (a standard depth of water over a given area of land).

◆ ASTM Manual E380 discourages the use of billion cubic meters since that magnitude is represented by giga (a thousand million) in other countries. It is shown here for potential use for quantifying large reservoir volumes (similar to million acre-feet).

### OTHER COMMON CONVERSION FACTORS

1 cubic foot=7.48 gallons=62.4 pounds of water

1 cubic foot per second (cfs)=450 gallons per minute (gpm)

1 cfs=646,320 gallons per day=1.98 af a day

1 acre-foot=approximately 325,851 gallons=43,560 cubic feet

1 million gallons=3.07 acre-feet

1 million gallons per day (mgd)=1,120 af a year



Los Angeles  Department of Water & Power

# URBAN WATER MANAGEMENT PLAN

2010





RESOLUTION NO. 011 268

WHEREAS, the California Urban Water Management Planning Act requires California water suppliers to prepare and adopt an Urban Water Management Plan every five years that describes their historical and future efforts in the area of water resources; and

WHEREAS, the Los Angeles Department of Water and Power (LADWP) has prepared a five-year update to the City of Los Angeles' Urban Water Management Plan (UWMP) pursuant to applicable provisions of Sections 10610 through 10656 of the California Water Code; and

WHEREAS, the UWMP is required as a condition of application for various water system grant and loan funding opportunities administered by the State of California; and

WHEREAS, LADWP has selected Method 3 of the four methods developed by the California Department of Water Resources for calculating the 2020 water use target and 2015 interim target in the UWMP as required in the California Water Conservation Act of 2009, SBX7-7; and

WHEREAS, LADWP's current water rate structure includes funding for water conservation, water recycling, and stormwater capture programs; and

WHEREAS, the development of the UWMP involved public meeting notices, public involvement, and incorporated oral and written public comments prior to final adoption; and

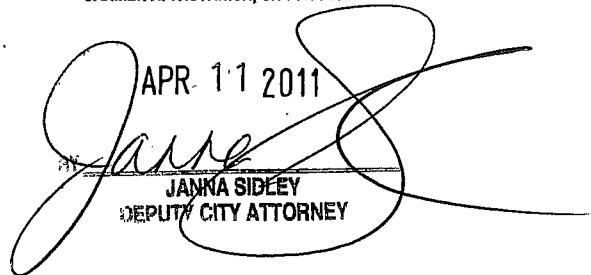
WHEREAS, the final UWMP must be adopted by LADWP's Board of Water and Power Commissioners and submitted to the California Department of Water Resources by July 1, 2011.

NOW, THEREFORE, BE IT RESOLVED, that the City of Los Angeles Department of Water and Power 2010 Urban Water Management Plan is hereby adopted; and

BE IT FURTHER RESOLVED that the President or Vice President of the Board, or the General Manager or such person as he shall designate in writing as his designee, and the Secretary, Assistant Secretary, or the Acting Secretary of the Board be and they are hereby authorized, empowered, and directed to approve said UWMP for and on behalf of LADWP.

I HEREBY CERTIFY that the foregoing is a full, true, and correct copy of a Resolution adopted by the Board of Water and Power Commissioners of the City of Los Angeles at its meeting held MAY 03 2011

APPROVED AS TO FORM AND LEGALITY  
CARMEN A. TRUTANICH, CITY ATTORNEY

APR 11 2011  
  
JANKA SIDLEY  
DEPUTY CITY ATTORNEY

  
Secretary



# Urban Water Management Plan Table of Contents

Note: The 2010 Urban Water Management Plan for the Los Angeles Department of Water and Power is available to the public at Los Angeles City Public Library, County of Los Angeles Public Library, West Hollywood Library, Culver City Julian Dixon Library, California State Library, and LADWP website at [www.ladwp.com](http://www.ladwp.com).

## Executive Summary

---

<b>ES-1 Overview and Purpose of Plan</b>	<b>1</b>
<b>ES-2 Existing Water Supplies</b>	<b>3</b>
<b>ES-3 Water Demands</b>	<b>6</b>
<b>ES-4 Water Conservation</b>	<b>11</b>
<b>ES-5 Future Water Supplies</b>	<b>14</b>
<b>ES-6 Water Supply Reliability</b>	<b>19</b>
<b>ES-7 Financing</b>	<b>24</b>
<b>ES-8 Conclusion</b>	<b>25</b>

## Chapter One - Introduction

---

<b>1.0 Overview</b>	<b>27</b>
<b>1.1 Purpose</b>	<b>28</b>
UWMP Requirements and Checklist	28
Water Supply Action Plan	28
<b>1.2 Service Area Description</b>	<b>30</b>
Land Use	30
Demographics	31
Climate	34
Water Demand and Supply Overview	34

## Chapter Two – Water Demands

---

<b>2.0</b>	<b>Overview</b>	<b>37</b>
<b>2.1</b>	<b>Historical Water Use</b>	<b>37</b>
	Water Use By Sector	38
	Indoor and Outdoor Water Use	39
<b>2.2</b>	<b>Quantification of Historical Water Conservation</b>	<b>41</b>
<b>2.3</b>	<b>Water Demand Forecast</b>	<b>42</b>
	Demand Forecast Methodology	42
	Applying the Methodology	43
	Water Demand Forecast Results	44
	Water Demand Forecast with Average Weather Variability	45
	Low-Income Water Demand Projections	46

## Chapter Three – Water Conservation

---

<b>3.0</b>	<b>Overview</b>	<b>47</b>
<b>3.1</b>	<b>Water Conservation Goals</b>	<b>50</b>
	Water Supply Action Plan Conservation Goal	51
	Water Conservation Act of 2009	51
<b>3.2</b>	<b>Existing Programs, Practices, and Technology to Achieve Water Conservation</b>	<b>52</b>
	State Laws and City Ordinances	53
	Conservation Pricing	56
	CUWCC Best Management Practices	57
	LADWP Conservation Programs	58
<b>3.3</b>	<b>Future Programs, Practices, and Technology to Achieve Water Conservation</b>	<b>71</b>
	Graywater	71
	Demand Hardening	75
	Projected Water Conservation Savings	75
<b>3.4</b>	<b>Cost and Funding</b>	<b>79</b>



## Chapter Four – Recycled Water

---

<b>4.0 Overview</b>	<b>81</b>
<b>4.1 Regulatory Requirements</b>	<b>83</b>
Non-Potable Reuse Regulations	83
Groundwater Replenishment Regulatory Requirements	87
<b>4.2 Wastewater Treatment Plants</b>	<b>88</b>
Donald C. Tillman Water Reclamation Plant	89
Los Angeles – Glendale Water Reclamation Plant	89
Terminal Island Water Reclamation Plant	89
Hyperion Treatment Plant	90
Projected Wastewater Volume	90
<b>4.3 Existing Recycled Water Deliveries</b>	<b>92</b>
Harbor Area	92
Metro Area	93
San Fernando Valley Area	94
Westside Area	95
Comparison of 2010 Projections Versus Actual Use	96
<b>4.4 Recycled Water Master Planning Documents</b>	<b>97</b>
Near-Term Projects Through 2015	99
Non-Potable Reuse Projects to be completed between 2015 - 2029	101
Groundwater Replenishment	102
Efforts Beyond 50,000 AFY	104
RWMP Cost and Funding	105
Outreach and Agency Coordination	105
Recycled Water Quality	107

## Chapter Five – Los Angeles Aqueduct System

---

<b>5.0</b>	<b>Overview</b>	<b>109</b>
<b>5.1</b>	<b>Historical Deliveries</b>	<b>110</b>
<b>5.2</b>	<b>Mono Basin and Owens Valley Source</b>	<b>112</b>
	Water Rights	112
<b>5.3</b>	<b>Environmental Issues and Mitigation</b>	<b>113</b>
	Mono Basin	113
	Lower Owens River Project	114
<b>5.4</b>	<b>Owens Lake Dust Mitigation</b>	<b>115</b>
<b>5.5</b>	<b>Water Quality</b>	<b>117</b>
<b>5.6</b>	<b>Projected Deliveries</b>	<b>118</b>
<b>5.7</b>	<b>LAA Delivery Cost</b>	<b>119</b>

## Chapter Six – Local Groundwater

---

<b>6.0</b>	<b>Overview</b>	<b>121</b>
<b>6.1</b>	<b>Groundwater Rights</b>	<b>121</b>
	The ULARA Groundwater Basin Adjudication	122
	Historical Groundwater Production	123
<b>6.2</b>	<b>San Fernando Basin</b>	<b>123</b>
	Groundwater Rights	124
	Water Quality	125
	Agency Cooperation of SFB Remediation	125
	San Fernando Basin Treatment	126
<b>6.3</b>	<b>Sylmar and Eagle Rock Basins</b>	<b>129</b>
	Groundwater Rights	129
	Water Quality	130
<b>6.4</b>	<b>Central Basin</b>	<b>130</b>
	Groundwater Rights	131
	Water Quality	131

<b>6.5 West Coast Basin</b>	<b>132</b>
Groundwater Rights	132
Water Quality	132
<b>6.6 Unadjudicated Basins</b>	<b>132</b>
<b>6.7 Water Quality Goals and Management</b>	<b>132</b>
Groundwater Monitoring	132
Operating Goals	133
Managing Emerging Contaminants of Concern	133
<b>6.8 Groundwater Pumping Costs</b>	<b>135</b>
<b>6.9 Groundwater Production Projections</b>	<b>135</b>

## **Chapter Seven – Watershed Management**

---

<b>7.0 Overview</b>	<b>137</b>
<b>7.1 Importance to Groundwater Supplies</b>	<b>139</b>
<b>7.2 Additional Benefits of Watershed Management</b>	<b>141</b>
<b>7.3 Stormwater Capture Master Plan</b>	<b>141</b>
<b>7.4 Tree People – Memorandum of Agreement</b>	<b>142</b>
<b>7.5 Centralized Stormwater Capture Projects</b>	<b>143</b>
<b>7.6 Distributed Stormwater Capture</b>	<b>146</b>
Watershed Council – Water Augmentation Study	147
Integrated Water Resources Plan Analysis	150
Distributed Stormwater Capture Projects	154
Low Impact Development and Best Management Practices	155
Future Distributed Stormwater Programs	157
<b>7.7 Integrated Regional Water Management Plan (IRWMP Program)</b>	<b>158</b>
<b>7.8 Cost Analysis</b>	<b>159</b>
<b>7.9 Summary</b>	<b>160</b>

## Chapter Eight – Metropolitan Water District Supplies

---

<b>8.0 Overview</b>	<b>163</b>
History	163
Governance	164
Service Area	164
Major Infrastructure	165
<b>8.1 Supply Sources</b>	<b>166</b>
Colorado River	166
State Water Project	175
In-Basin Storage	184
Groundwater Storage and Water Transfers	187
<b>8.2 MWD Supply Reliability and Projected LADWP Purchase</b>	<b>191</b>
<b>8.3 MWD Rate Structure and LADWP’s Purchase Water Costs</b>	<b>191</b>
MWD Rate Structure	191
LADWP’s Purchased Water Costs	192

## Chapter Nine – Other Water Supplies

---

<b>9.0 Overview</b>	<b>195</b>
<b>9.1 Water Transfers and Banking</b>	<b>195</b>
LADWP Opportunities	196
MWD Opportunities	197
<b>9.2 Seawater Desalination</b>	<b>199</b>
Desalination Technology	199
DWR Desalination Efforts	200
MWD Desalination Efforts	201
LADWP Seawater Desalination Efforts	201
<b>9.3 Other Water Supplies Yield and Cost</b>	<b>204</b>

## Chapter Ten – Integrated Resources Planning

---

<b>10.0 Overview</b>	<b>205</b>
<b>10.1 City of Los Angeles Integrated Water Resources Plan</b>	<b>205</b>
Description and Purpose	205
Integrated Watershed Approach	206
Stakeholder Involvement	206
IRP Alternatives	207
Implementation Status	207
Agency Coordination	212
IRP Implication for City’s UWMP	212
<b>10.2 Greater Los Angeles Integrated Regional Water Management Plan</b>	<b>212</b>
Description and Purpose	212
Stakeholder Involvement	214
Recommended Projects	214
Implication for LADWP’s UWMP	217
<b>10.3 MWD’s 2010 Integrated Resources Plan</b>	<b>218</b>
Stakeholder Participation	219
Funding MWD’s IRP	220
Implication for City’s UWMP	220

## Chapter Eleven – Water Service Reliability and Financial Integrity

---

<b>11.0 Overview</b>	<b>221</b>
<b>11.1 Unit Cost and Funding of Supplies</b>	<b>221</b>
Unit Cost Summary of Supplies	221
Funding of Supplies	223
<b>11.2 Reliability Assessment Under Different Hydrologic Conditions</b>	<b>223</b>
Los Angeles Aqueducts	223

Groundwater	224
Conservation	224
Recycled Water	224
Water Transfers	225
MWD Imported Supplies	225
Potential Supplies	227
Service Area Reliability Assessment	227
<b>11.3 Water Shortage Contingency Plan</b>	<b>236</b>
Stages of Action	236
Driest Three-Year Supply	238
Catastrophic Supply Interruption Plan	239
Mandatory Water Use Prohibitions	240
Consumption Reduction Methods during Most Restrictive Stages	242
Penalties for Excessive Use	243
Analysis and Effects on Revenues and Expenditures of Reduced Sales During Shortages	244
Water Shortage Contingency Resolution or Ordinance	244
Methodology to Determine Actual Water Use Reductions During Shortages	245
<b>11.4 Water Supply Assessments</b>	<b>246</b>
Background	246
Methodology	248
WSA Procedure	248

## Chapter Twelve – Climate Change

---

<b>12.0 Overview</b>	<b>251</b>
<b>12.1 Potential Impacts of Climate Change on Water Service Reliability</b>	<b>251</b>
Local Impacts	252
Los Angeles Aqueduct Impacts	254

State Water Project Impacts	257
Colorado River Aqueduct Impacts	259
<b>12.2 Water and Energy Nexus</b>	<b>259</b>
State Water Project Supplies	260
Colorado River Aqueduct Supplies	262
Los Angeles Aqueduct Supplies	262
Local Groundwater Supplies	262
Recycled Water Supplies	263
Treatment Energy	263
Distribution Energy	264
Carbon Footprint	266
<b>12.3 Climate Change Adaption and Mitigation</b>	<b>268</b>
LADWP Adaption and Mitigation	269
MWD Adaption and Mitigation	270

## Appendices

---

Appendix A	Urban Water Management Planning Act	273
Appendix B	Urban Water Management Plan Checklist and Standard Tables	291
Appendix C	Water Rate Ordinance	309
Appendix D	Notice of Meetings and Public Comments	321
Appendix E	References	397
Appendix F	Groundwater Basin Adjudications	403
Appendix G	Calculating LADWP's 20x2020 Water Use Target	451
Appendix H	CUWCC Biennial Report	457
Appendix I	Emergency Water Conservation Plan	523





**Urban Water  
Management Plan  
List of Exhibits**

## **Executive Summary**

---

ES-A	L.A. Water Supplies	4
ES-B	LADWP Historical Water Supply Sources (1980-2010)	5
ES-C	Demographic Projections for LADWP’s Service Area	7
ES-D	Average Climate Data for Los Angeles	7
ES-E	Historical Total Water Demand in LADWP’s Service Area	8
ES-F	Breakdown in Historical Water Demand for LADWP’s Service Area	8
ES-G	Indoor and Outdoor Water Use in LADWP’s Service Area	9
ES-H	Water Demand Forecast and Conservation Savings Under Average Weather Fiscal Year Ending June 30 (Acre-feet)	10
ES-I	LADWP Water Demand Forecast with Average Weather Variability	10
ES-J	Historical Water Conservation in LADWP’s Service Area	11
ES-K	Active Water Conservation Projects	12
ES-L	20x2020 Base and Target	12
ES-M	Water Conservation BMPs and Implementation Status	13
ES-N	City Wastewater Plants and Sewersheds	14
ES-O	Recycled Water Use Projections	15
ES-P	Planned Centralized Stormwater Capture Programs	16
ES-Q	Current and Projected Mix of LADWP’s Water Supplies	19
ES-R	Service Area Reliability Assessment for Average Weather Year	20
ES-S	Driest Three-Year Water Supply Sequences	21
ES-T	Projected Runoff, Snow-Water Equivalent, and Rain-to-Snow Ratio for Eastern Sierra Nevada Watershed	24

## Chapter One - Introduction

---

Exhibit 1A City of Los Angeles Land Uses	30
Exhibit 1B Historical Demographics for LADWP Service Area	31
Exhibit 1C Demographic Projections for LADWP Service Area	32
Exhibit 1D Comparison of SCAG Demographic Projections for LADWP Service Area Between 2004 and 2008 TRP Forecasts for Year 2030	33
Exhibit 1E Average Climate Data for Los Angeles	34
Exhibit 1F LADWP Historical Water Supply Sources 1980-2010	35

## Chapter Two – Water Demands

---

Exhibit 2A Historical Total Water Demand in LADWP’s Service Area	37
Exhibit 2B Historical Per Capita Water Use in LADWP’s Service Area	38
Exhibit 2C Breakdown in Historical Water Demand for LADWP’s Service Area	39
Exhibit 2D Indoor Vs. Outdoor Water Use in LADWP’s Service Area	40
Exhibit 2E Modeled Vs. Actual Monthly Water Consumption for LADWP	41
Exhibit 2F Estimates of Total Water Conservation in LADWP’s Service Area	42
Exhibit 2G Projected Demographic Drivers	43
Exhibit 2H Baseline Unit Water Use Rates (2005-2008)	43
Exhibit 2I Projected Unit Water Use	44

Exhibit 2J	Water Demand Forecast and Conservation Savings Under Average Weather Fiscal Year Ending June 30	45
Exhibit 2K	Water Demand Forecast with Average Weather Variability	45
Exhibit 2L	Water Demand Forecast for Low-Income Residential Customers Fiscal Year Ending June 30	46

## Chapter Three – Water Conservation

---

Exhibit 3A	Historical City of Los Angeles Water Use	48
Exhibit 3B	Historical City of Los Angeles Conservation	49
Exhibit 3C	20x2020 Base and Target Data	52
Exhibit 3D	Water Efficiency Requirements Ordinance Summary	54
Exhibit 3E	Emergency Water Conservation Plan Ordinance Restrictions by Phase	55
Exhibit 3F	CUWCC BMPs and Implementation Status	58
Exhibit 3G	Current and Past Conservation Programs	60
Exhibit 3H	CII Conservation Programs and Savings July 2007 through June 2010	64
Exhibit 3I	Active Conservation Projections by Sector	76
Exhibit 3J	Breakdown of Estimated CII Indoor Water Conservation Potential of 23,000 AF	77
Exhibit 3K	Potential Outdoor Water Use Savings by Sector	78

## Chapter Four – Recycled Water

---

Exhibit 4A City Wastewater Plants and Sewersheds	82
Exhibit 4B Allowable Title 22 Recycled Water Uses	84
Exhibit 4C Wastewater Treatment Plants Summary	88
Exhibit 4D Wastewater Treatment Plant Average Dry-Weather Flows, Reuse and Discharge Method	90
Exhibit 4E	91
Exhibit 4F Harbor Recycling	92
Exhibit 4G Metro Recycling	93
Exhibit 4H Valley Recycling	94
Exhibit 4I Westside Recycled Water System Existing Annual Demand	95
Exhibit 4J 2005 UWMP Recycled Water Projections for 2010 Versus Actual Use	97
Exhibit 4K Recycled Water Master Planning Documents Implementation Timeline	97
Exhibit 4L Recycled Water Use Projections	98
Exhibit 4M Harbor Area Near-Term Estimated Demands	99
Exhibit 4N Metro Area Near-Term Estimated Demands	100
Exhibit 4O Valley Area Near-Term Estimated Demands	100
Exhibit 4P Westside Area Near-Term Estimated Demands	101
Exhibit 4Q Project Option Demands by Service Area	101
Exhibit 4R Recycled Water Agency Coordination	106

## Chapter Five – Los Angeles Aqueduct System

---

Exhibit 5A Los Angeles Aqueduct System	109
Exhibit 5B Mono Basin and Owens Valley Water Use Allocations	110
Exhibit 5C Historical Los Angeles Aqueduct Deliveries	111
Exhibit 5D Eastern Sierra Nevada Runoff Owens Valley – Percent of Normal	112
Exhibit 5E Mono Basin and Owens River Environmental Enhancement Commitments	113
Exhibit 5F Mono Lake Elevation and Exports	114
Exhibit 5G Lower Rush Creek Base and Peak Flow Requirements	114
Exhibit 5H Lower Owens River Project Area	115
Exhibit 5I Lower Owens River Base and Peak Seasonal Habitat Flow Requirements	115
Exhibit 5J Yearly Water Use on Owens Lake (Fiscal Year)	116
Exhibit 5K Dust Control Mitigation Best Available Control Measures	117
Exhibit 5L Historical Cost of LAA Treated Water	119
Exhibit 5M Annual Unit Cost	119

## Chapter Six – Local Groundwater

---

Exhibit 6A Annual Local Groundwater Entitlement	121
Exhibit 6B Local Groundwater Basin Supply	123
Exhibit 6C San Fernando Basin	124
Exhibit 6D Operating Limits of Regulated Compounds	133
Exhibit 6E Historical Cost of Groundwater Pumping	135
Exhibit 6F Annual Unit Cost	135
Exhibit 6G Groundwater Production 2010 to 2035 for Average, Single-Dry, and Multi-Year Dry Weather Condition By Fiscal Year	136

## Chapter Seven – Watershed Management

---

Exhibit 7A SFB Spreading Grounds Operations Data	139
Exhibit 7B Spreading Ground Facility Locations	140
Exhibit 7C Planned Centralized Stormwater Capture Programs	143
Exhibit 7D Potential Non-Potable Water Demands Met with Dry Weather Treated Runoff	150
Exhibit 7E Construction of Underground Cistern for Stormwater Capture	152
Exhibit 7F Underground Storage Potential Throughout the City	153
Exhibit 7G Cost Analysis	159
Exhibit 7H Stormwater Capture Summary	161

## Chapter Eight – Metropolitan Water District Supplies

---

Exhibit 8A MWD Service Area	164
Exhibit 8B Major MWD Facilities Summary	165
Exhibit 8C Major MWD Facilities	165
Exhibit 8D Listing of Priorities – Seven Party Agreement	167
Exhibit 8E Historical Annual Colorado River Supply and Use	168
Exhibit 8F Historical Total Colorado River Basin Storage	170
Exhibit 8G Historical Lake Mead Elevation	171
Exhibit 8H MWD’s CRA Forecast Supplies in 2035, Average Year (1922-2004 Hydrology)	172
Exhibit 8I State Water Project Major Facilities	176
Exhibit 8J Table A Maximum Annual SWP Amounts (acre-feet)	178
Exhibit 8K MWD Forecast Supplies of SWP Water in 2035, Average Year (1922-2004 Hydrology)	180
Exhibit 8L MWD’s In-basin Surface Reservoir Capacity	185
Exhibit 8M MWD Forecast Supplies of In-Basin Surface Storage Supplies in 2035, Average Year (1922-2004 Hydrology)	185
Exhibit 8N In-Basin Conjunctive Use Programs	186
Exhibit 8O MWD Forecast Supplies of In-Basin Groundwater Storage in 2035, Average Year (1922-2004 Hydrology)	187
Exhibit 8P MWD Forecast Supplies of Groundwater Storage and Transfers in 2035, Average Year (1922-2004 Hydrology)	188

Exhibit 8Q MWD Historic Central Valley Water Transfers	189
Exhibit 8R MWD System Forecast Supplies and Demands, Average Year (1922-2004 Hydrology)	190
Exhibit 8S MWD Rates and Charges	192
Exhibit 8T Percentage of LADWP's Purchased Water in Various MWD Rate Categories	193

## **Chapter Nine – Other Water Supplies**

---

Exhibit 9A Desalination Efforts in MWD Service Area	202
Exhibit 9B Other Water Supplies	204

## **Chapter Ten – Integrated Resources Planning**

---

Exhibit 10A MWD's IRP Resource Targets	218
Exhibit 10B Meeting Regional Water Needs Through MWD's IRP	219

## **Chapter Eleven – Water Service Reliability and Financial Integrity**

---

Exhibit 11A Unit Costs of Supplies	222
Exhibit 11B MWD Supply Capability and Projected Demands (in AFY)	226
Exhibit 11C LADWP Supply Reliability FYE 2006-2010 Average	228
Exhibit 11D LADWP Supply Reliability Under Average Weather Conditions in Fiscal Year 2034-2035	228



Exhibit 11E	Service Area Reliability Assessment for Average Weather Year	229
Exhibit 11F	Service Area Reliability Assessment for Single Dry Year	230
Exhibit 11G	Service Area Reliability Assessment for Multi-Dry Years (2011-2015)	231
Exhibit 11H	Service Area Reliability Assessment for Multi-Dry Years (2016-2020)	232
Exhibit 11I	Service Area Reliability Assessment for Multi-Dry Years (2021-2025)	233
Exhibit 11J	Service Area Reliability Assessment for Multi-Dry Years (2026-2030)	234
Exhibit 11K	Service Area Reliability Assessment for Multi-Dry Years (2031-2035)	235
Exhibit 11L	Driest Three-Year Water Supply Sequence	238
Exhibit 11M	Draft Water Shortage Contingency Declaration Resolution	245

## Chapter Twelve – Climate Change

---

Exhibit 12A	Climate Change Impacts to Local Temperatures for Los Angeles	253
Exhibit 12B	Climate Change Impacts to Local Precipitation for Los Angeles	253
Exhibit 12C	30-Year Time Series Projected Temperature Means for Eastern Sierra Nevada Watershed	255
Exhibit 12D	30-Year Time Series Projected Precipitation Means for Eastern Sierra Nevada Watershed	255
Exhibit 12E	Projected Runoff, Snow-Water Equivalent, and Rain-to-Snow Ratio for Eastern Sierra Nevada Watershed	256
Exhibit 12F	Projected Rain to Precipitation Ratio Based on Projected Precipitation and Temperature	257
Exhibit 12G	Climate Change Impacts on SWP Delivery	258

Exhibit 12H	Energy Intensity of LADWP’s Water Sources	261
Exhibit 12I	Proportion of Volume Delivered and Total Energy Intensity (Inclusive of Treatment)	264
Exhibit 12J	LADWP Energy Intensity 2003-2009	265
Exhibit 12K	LADWP Annual Energy Intensity	266
Exhibit 12L	Annual Footprint by Carbon Source	267
Exhibit 12M	Total Annual Carbon Footprint for Water Supply Portfolio	268

## Urban Water Management Plan List of Case Studies

---

Los Angeles River Revitalization and the North Atwater Park Project	68
Single-Family Home Graywater System	73
Elmer Avenue Neighborhood Retrofit Project	148
Ballona Creek Watershed Rainwater Harvesting Pilot Program	151
Woodman Avenue Multi-Beneficial Stormwater Capture Project	156

**Urban Water  
Management Plan**  
**Glossary of  
Abbreviations  
and Terms**

**Agencies**

AVEK	Antelope Valley-East Kern Water Agency
BOE	City of Los Angeles Department of Public Works, Bureau of Engineering
BOS	City of Los Angeles Department of Public Works, Bureau of Sanitation
Caltrans	California Department of Transportation
CDPH	California Department of Public Health
CDTSC	California Department of Toxic Substance Control
CITY	City of Los Angeles
CUWCC	California Urban Water Conservation Council
CVWD	Coachella Valley Water District
DWR	California Department of Water Resources
IAPMO	International Association of Plumbing and Mechanical Officials
IID	Imperial Irrigation District
KERN-DELTA	Kern Delta Water District
LACDPH	Los Angeles County Department of Public Health
LACDPW	Los Angeles County Department of Public Works
LACFCD	Los Angeles County Flood Control District
LADBS	Los Angeles Department of Building and Safety
LADWP	Los Angeles Department of Water and Power
LARWQCB	Los Angeles Regional Water Quality Control Board
LASGRWC	Los Angeles and San Gabriel Rivers Watershed Council
LBWD	Long Beach Water Department
MWD	Metropolitan Water District of Southern California
NWRI	National Water Research Institute
PVID	Palo Verde Irrigation District
RWAG	Recycled Water Advisory Group
RWQCB	Regional Water Quality Control Board
SBMWD	San Bernardino Municipal Water District
SCAG	Southern California Association of Governments
SWRCB	State Water Resources Control Board
USBR	United States Bureau of Reclamation
USEPA	United States Environmental Protection Agency
WBMWD	West Basin Municipal Water District
WRD	Water Replenishment District

### Facilities and Locations

AWTF	Advanced Water Treatment Facility
BAY-DELTA	San Francisco Bay and Sacramento-San Joaquin River Delta
CRA	Colorado River Aqueduct
DCT	Donald C. Tillman Water Reclamation Plant
ECLWRF	Edward C. Little Water Recycling Facility
EOC	Emergency Operations Center
HTP	Hyperion Treatment Plant
JWPCP	Joint Water Pollution Control Plant
LAA	Los Angeles Aqueducts (First and Second)
LAAFP	Los Angeles Aqueduct Filtration Plant
LAG	Los Angeles/Glendale Water Reclamation Plant
LVMWD	Las Virgenes Municipal Water District
NTPS	Neenach Temporary Pumping Station
RWMP	Recycled Water Master Plan
SFB	San Fernando Basin
SWP	State Water Project
TIWRP	Terminal Island Water Reclamation Plant
ULARA	Upper Los Angeles River Area

### Measurements and Miscellaneous

ACT	Urban Water Management Planning Act
AF	Acre-Feet
AFY	Acre-Feet Per Year
BACM	Best Available Control Measures
BDCP	Bay Delta Conservation Plan
BMP	Best Management Practices
CBO	Community-Based Organizations
CEQA	California Environmental Quality Act
CFS	Cubic Feet Per Second
CII	Commercial/Industrial/Institutional
CIP	Capital Improvement Program
CVP	Central Valley Project
EIR	Environmental Impact Report
ERP	Emergency Response Plan
FY	Fiscal Year
FYE	Fiscal Year Ending
GAC	Granular Activated Carbon
GCM	Global Climate Models
GHG	Greenhouse Gases
GPCD	Gallons Per Capita Per Day
GPD	Gallons Per Day
GPF	Gallons Per Flush
GPM	Gallons Per Minute
GSIS	Groundwater System Improvement Study
GWR	Groundwater Replenishment
HET	High Efficiency Toilets
IAP	Independent Advisory Panel
IRP	Integrated Resources Plan
IAWP	Interim Agricultural Water Program

IRWMP	Integrated Regional Water Management Plan
KWh/AF	Kilowatt-Hour per Acre-Foot
LID	Low Impact Development
LRP	Long-Range Finance Plan
M&I	Municipal and Industrial
MAF	Million Acre-Feet
MCL	Maximum Contaminant Level
MF/RO	Microfiltration/Reverse Osmosis
MGD	Million Gallons Per Day
MOA	Memorandum of Agreement
MOU	Memorandum of Understanding
NDMA	N-nitrosodimethylamine
NdN	Nitrification/Denitrification
NPR	Non-Potable Water Reuse
PCE	Perchloroethylene
PPB	Parts Per Billion
PPCPs	Pharmaceuticals and Personal Care Products
PPM	Parts Per Million
QSA	Quantification Settlement Agreement
RI	Remedial Investigation
ROD	Record of Decision
RTP	Southern California Association of Governments Regional Transportation Plan
RWMP	Recycled Water Master Plan
RUWMP	Regional Urban Water Management Plan (Prepared by MWD)
SB	Senate Bills
SOC	Synthetic Organic Compounds
SUSMP	Standard Urban Stormwater Mitigation Plan
STORMWATER PLAN	Stormwater Capture Master Plan
SWAT	Irrigation Association Smart Water Application Technologies
SWE	Snow Water Equivalent
TAF	Thousand Acre-Feet
TAP	Technical Assistance Program
TCE	Trichloroethylene
TDMLs	Total Maximum Daily Loads
TOC	Total Organic Carbon
ULF	Ultra-Low Flush
UWMP	Urban Water Management Plan
VOCs	Volatile Organic Compounds
WAS	Los Angeles Basin Water Augmentation Study
WBICs	Weather-Based Irrigation Controllers
WQCM PUR	Water Quality Compliance Master Plan for Urban Runoff
WRR	Water Recycling Requirements
WSA	Water Supply Assessment
WSAP	Metropolitan Water District's Water Supply Allocation Plan
WSDM Plan	Water Surplus and Drought Management Plan
20x2020	Reduce Per Capita Water Use by 20 Percent by 2020; Senate Bill x7-7



# Executive Summary

## ES-1 Overview and Purpose of Plan

---

In 1902, the City created a municipal water system by acquiring title to all properties of a private water company. In 1925, the Los Angeles Department of Water and Power (LADWP) was established by a new city charter. The availability of water has significantly contributed towards the economic development of the City of Los Angeles (City). It has supported the City's need for water resources as it has developed from a town with a population of approximately 146,000 residents in 1902, into the nation's second largest city with over 4 million residents, encompassing a 473 square mile area. As the largest municipal utility in the nation, LADWP delivers safe and reliable water and electricity supplies at an affordable price to the residents and businesses of Los Angeles.

### Overview of Water Issues

LADWP, along with all other water agencies in Southern California, is faced with the challenge of providing a reliable and high quality water supply to meet current and future needs. In the past five years, water supplies in California and locally have become scarcer due to multi-year dry weather and regulatory restrictions affecting water supplies originating in the Sacramento-San Joaquin Delta (Bay Delta) and Colorado River Basin. It is projected that imported and local water supplies will be adversely affected by global climate change. Finally, contamination of local groundwater has resulted in reduced groundwater supplies for the City.

To address these issues, LADWP will take

the following water management actions in order to meet the City's water needs while maximizing local resources and minimizing the need to import water:

- Significantly enhance water conservation, stormwater capture and recycling projects to increase supply reliability.
- Implement treatment for San Fernando Basin groundwater supplies.
- Ensure continued reliability of the water supplies from the Metropolitan Water District of Southern California (MWD) through active representation of City interests on the MWD Board.
- Maintain the operational integrity of the Los Angeles Aqueduct (LAA) and in-City water distribution systems.
- Meet or exceed all Federal and State standards for drinking water quality.

### Purpose of Plan

The California Urban Water Management Planning Act (first effective on January 1, 1984) requires that every urban water supplier prepare and adopt an Urban Water Management Plan (UWMP) every five years. Since its original enactment, there have been several amendments added to the Act. The main goal of the UWMP is to forecast future water demands and water supplies under average and dry year conditions, identify future water supply projects such as recycled water, provide a summary of water conservation best management practices (BMPs), and provide a single and multi-dry year management strategy.



LADWP's 2010 UWMP serves two purposes: (1) achieve full compliance with requirements of California's Urban Water Management Planning Act; and (2) serve as a master plan for water supply and resources management consistent with the City's goals and policy objectives.

### **Changes Since 2005 UWMP**

A number of important changes have occurred since LADWP prepared its 2005 UWMP. First, LADWP released its Water Supply Action Plan (Action Plan) in 2008 to address the water reliability issues associated with the lowest snowpack on record in the Sierra Nevada (in 2007), the driest year on record for the Los Angeles Basin (in 2007), increased water for environmental mitigation and enhancement in the Owens Valley, San Fernando Groundwater Basin contamination, and reduced imported water from the Bay-Delta due to a prolonged water shortage and environmental restrictions on Delta exports. Second, a number of new requirements were added to the Urban Water Management Planning Act,

such as addressing California's new mandate of reducing per capita water use by 20 percent by the year 2020. And third, LADWP developed a new water demand forecast based on a more rigorous analysis of water use trends and measurement of achieved water conservation.

As a result of these changes, the implementation plan and schedule in the 2005 UWMP have been revised as follows:

- The Water Supply Action Plan provided more focused strategies as described in Section 1.1.2 with more conservation and recycled water than the amounts planned in the 2005 UWMP.
- Owens Lake Dust Mitigation water use exceeded the 55,000 AFY estimated in 2005 UWMP and resulted in reduced LAA deliveries.
- Groundwater production decreased due to expanded San Fernando Groundwater Basin contamination impacts.



- Seawater desalination was removed from planned water supplies due to concerns over high cost and environmental impacts.
- The schedule for water transfers was postponed because the California Aqueduct interconnection with the Los Angeles Aqueduct has not yet been constructed.

## ES-2 Existing Water Supplies

Primary sources of water for the LADWP service area are the Los Angeles Aqueducts (LAA), local groundwater, and purchased imported water from MWD (see Exhibit ES-A). An additional fourth source, recycled water, is increasingly becoming a larger source in the overall supply portfolio. Two of the supply sources, LAA and water purchased from MWD, are classified as imported as they are obtained from outside LADWP’s service area. MWD is the regional wholesale water agency, importing water from the Bay-Delta via the State Water Project (SWP) and from the Colorado River via the Colorado River Aqueduct (CRA). Groundwater is local and is obtained within the service

area. Historical supply sources are increasingly under multiple constraints including potential impacts of climate change, groundwater contamination, and reallocation of water for environmental concerns. To mitigate these impacts on supply sources, LADWP is modifying its water supply portfolio through increased water use efficiency programs, water recycling, and stormwater capture.

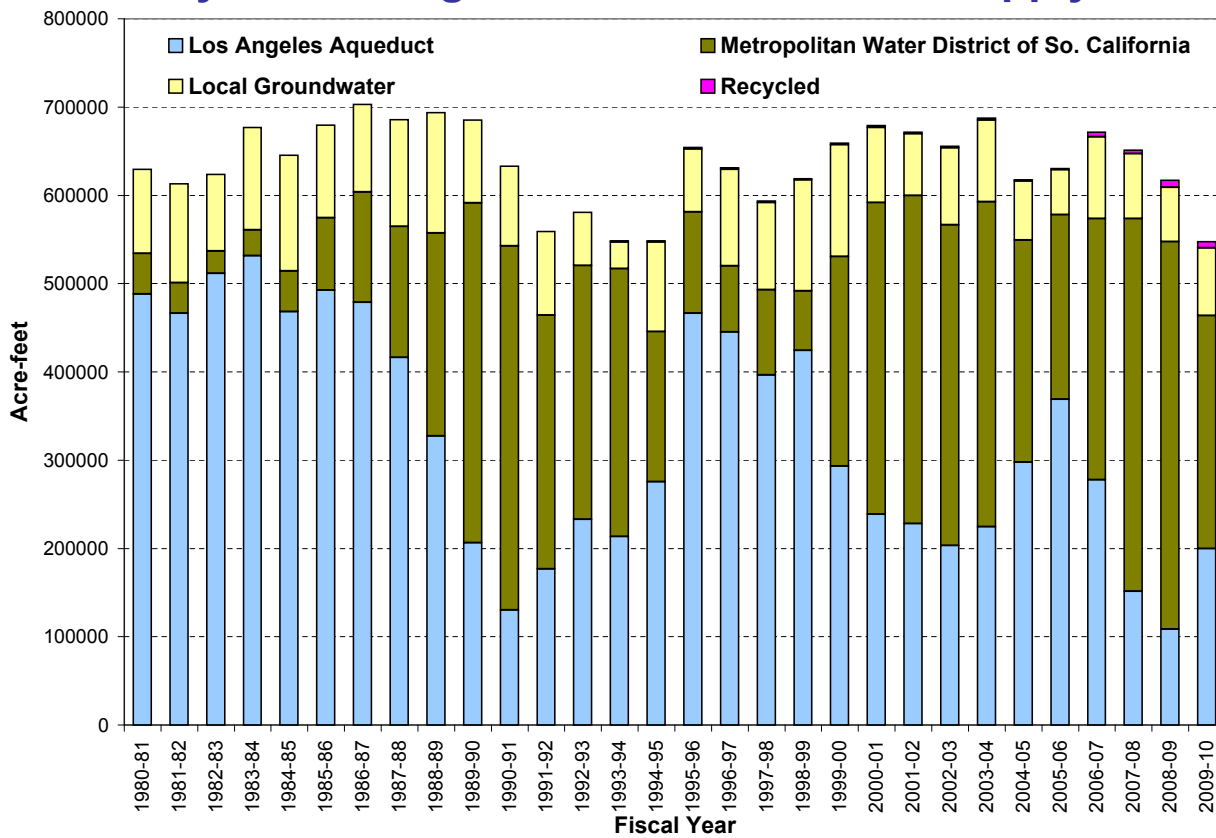
The challenge of water management in California is the year-to-year variability in availability of surface water due to hydrologic conditions from wet and dry years. Also, environmental regulations can result in temporary or permanent restrictions in certain water supplies. For example, recent pumping restrictions in the Bay-Delta resulted in MWD restricting the availability of imported water to LADWP. The LAA supply has also seen reductions in availability due to dry years and environmental mitigation and enhancement needs. Exhibit ES-B shows LADWP’s historical water supplies from fiscal year (FY) 1980/81 to 2009/10. The supplies in FY 2009/10 are much lower due to the mandatory water use restrictions LADWP imposed on its customers in response to the prolonged statewide supply shortage and environmental regulations reducing pumping from the Bay-Delta.



**ES-A L.A. Water Supplies**



## City of Los Angeles Sources of Water Supply



### Recycled Water

In 1979, LADWP began delivering recycled water to the Department of Recreation and Parks for irrigation of areas in Griffith Park. This service was later expanded to include Griffith Park's golf courses. In 1984, freeway landscaping adjacent to the park was also irrigated with recycled water. In addition, the Japanese Garden, Balboa Lake and Wildlife Lake in the Sepulveda Basin now utilize recycled water for environmentally beneficial reuse purposes. The Greenbelt Project, which carries recycled water from the Los Angeles-Glendale Water Reclamation Plant to Forest Lawn Memorial Park, Mount Sinai Memorial Park, Lakeside Golf Club of Hollywood and Universal Studios, began operating in 1992, and represents LADWP's first project to supply recycled water to non-governmental customers. In 2009 phase 1 of the Playa Vista development began receiving recycled water. Playa Vista is the first planned development in the City that uses recycled

water to meet all landscape needs. Future recycled water projects will continue to build on the success of these prior projects making recycled water a more prominent component of the City's water supply portfolio. LADWP expects to increase the use of recycled water to 59,000 AFY by 2035.

### Los Angeles Aqueduct

Since its construction in the early 1900's, the Los Angeles Aqueduct historically provided the vast majority of water for the City. It remains as a significant water supply source, providing an average of 36 percent of total water supplies from FY 2005/06 to 2009/10. In the last decade environmental considerations have required that the City reallocate approximately one-half of the Los Angeles Aqueduct (LAA) water supply to environmental mitigation and enhancement projects. As a result, approximately 205,800 AF of water supplies for environmental mitigation

and enhancement in the Owens Valley and Mono Basin regions were used in 2010, which is in addition to the almost 107,300 acre-ft per year (AFY) supplied for agricultural, stockwater, and Native American Reservations. Reducing water deliveries to the City from the LAA has led to increased dependence on imported water supply from MWD. This need for purchased water has reinforced LADWP's plans to focus on developing local supplies.

### **Local Groundwater**

A key resource that the City has relied upon as the major component of its local supply portfolio is local groundwater. Over the last ten years local groundwater has provided approximately 12 percent of the total water supply for Los Angeles, and historically has provided nearly 30 percent of the City's total supply during droughts when imported supplies become unreliable. In recent years, contamination issues have impacted LADWP's ability to fully utilize its local groundwater entitlements. Additionally, reduction of natural infiltration due to expanding urban hardscape and channelization of stormwater runoff has resulted in declining groundwater elevations. In response to contamination issues and declining groundwater levels, LADWP is working to clean up the San Fernando Basin's groundwater, and is making investments to recharge local groundwater basins through stormwater recharge projects, while at the same time collaborating on rehabilitation of aging stormwater capture and spreading facilities. The San Fernando Basin is a fully adjudicated basin with an active Watermaster and Administrative Committee.

### **MWD Supply**

As a wholesaler, MWD sells water to all of its 26 member agencies. LADWP is exclusively a retailer and has historically purchased MWD water to make up the deficit between demand and other City supplies. As a percentage of the City's total water supply, purchases of MWD

water have historically varied from 4 percent in FY 1983/84 to 71 percent in FY 2008/09, with a 5-year average of 52 percent between FY 2005/06 and FY 2009/10. The City relies on MWD water even more in dry years and has increased its dependence in recent years as LAA supply has been reduced. Although the City plans to reduce its reliance on MWD supply, it has made significant investments in MWD anticipating that the City will continue to rely on the wholesaler to meet its current and future supplemental water needs.

## **ES-3 Water Demands**

---

Water demands are driven by a number of factors: demographics (population, housing and employment); implementation of water conservation programs; behavioral practices of water users; and weather. For the development of LADWP's 2010 UWMP, a new water demand forecast was prepared using: (1) the latest trends in water use; (2) econometric-derived elasticities for estimating the impacts of weather, price of water, income, and family size on per household and per employee water use; and (3) more accurate estimates of the effectiveness of water conservation in the City.

### **Demographics and Climate**

Over 4 million people reside in the LADWP service area which is slightly larger than the legal boundary of the City of Los Angeles. LADWP provides water service outside the City's boundary to portions of West Hollywood, Culver City, Universal City, and small parts of the County of Los Angeles. The population within LADWP's service area increased from 2.97 million in 1980 to 4.1 million in 2009, representing an average annual growth rate of 1.3 percent. The total number of housing units increased from 1.10 million in 1980 to 1.38 million in 2009, representing an average annual growth rate of 0.9 percent.

During this time, average household size increased from 2.7 persons in 1980 to 2.9 persons in 2009. Employment grew by about 1.0 percent annually from 1980 to 1990, but declined from 1990 to 2000 as a result of an economic recession that started in 1991. Another decline in employment began in 2008 reflecting the recent economic recession. Overall, employment increased by about 0.3 percent annually from 1990 to 2009.

Demographic projections for LADWP's service area are based on the 2008 forecast generated by the Southern California Association of Governments (SCAG). Exhibit ES-C summarizes these demographic projections for the LADWP service area. Service area population

is expected to increase at a rate of 0.4 annually over the next 25 years. While this growth is substantially less than the historical 1.3 percent annual growth rate from 1980 to 2009, it will still lead to approximately 367,300 new residents over the next 25 years.

Weather in Los Angeles is considered mild with blue skies, and sunshine throughout most of the year. Favorable weather is a popular attribute that attracts businesses, residents, and tourists to the City. Because of its relative dryness, Los Angeles' climate has been characterized as Mediterranean. Exhibit ES-D provides a summary of average monthly rainfall, maximum temperatures, and evapotranspiration readings.

### Exhibit ES-C Demographic Projections for LADWP Service Area

Demographic	2010	2015	2020	2025	2030	2035
<b>Population</b>	4,100,260	4,172,760	4,250,861	4,326,012	4,398,408	4,467,560
<b>Housing</b>						
Single-Family	627,395	646,067	665,261	678,956	691,703	701,101
Multi-Family	764,402	804,013	846,257	880,580	914,125	942,846
Total Housing	1,391,797	1,450,080	1,511,518	1,559,536	1,605,828	1,643,947
Persons per Household	2.88	2.81	2.75	2.71	2.67	2.65
<b>Employment</b>						
Commercial	1,674,032	1,724,106	1,754,998	1,790,798	1,828,765	1,865,156
Industrial	163,382	157,652	155,012	152,426	150,009	147,508
Total Employment	1,837,415	1,881,758	1,910,010	1,943,224	1,978,773	2,012,664

Source: SCAG Regional Transportation Plan (2008), modified using MWD's land use planning to represent LADWP's service area.

### Exhibit ES-D Average Climate Data for Los Angeles 1990-2010

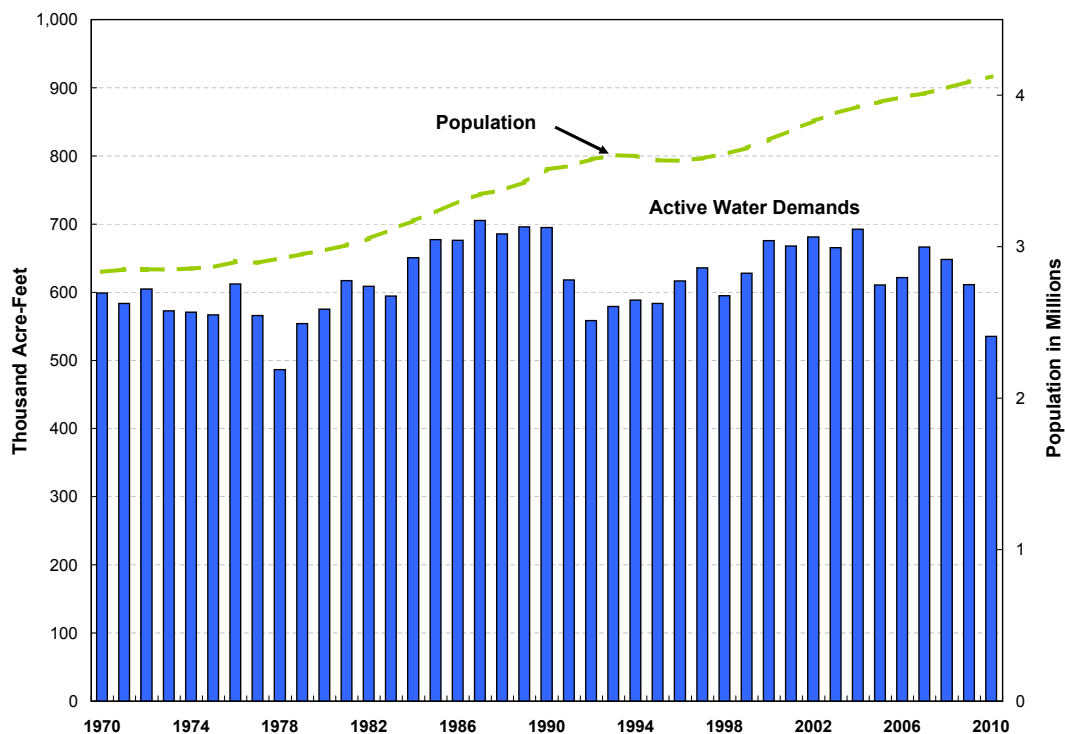
	Jan	Feb	Mar	Apr	May	Jun	Jul	Aug	Sep	Oct	Nov	Dec	Annual
Average Maximum Temperature (°F) <sup>1</sup>	68	68	70	73	75	78	83	85	83	79	73	68	75
Average Precipitation (inches) <sup>1</sup>	3.62	4.46	2.28	0.75	0.34	0.12	0.01	0	0.07	0.68	0.72	2.53	15.58
Average Eto (inches) <sup>2,3</sup>	1.98	2.26	3.66	4.96	5.46	6.08	6.46	6.31	4.87	3.63	2.56	2.03	50.26

1. 1990-2010, Los Angeles Downtown USC Weather Station ID 5115

2. Average of Hollywood Hills (Station Id. 73), Glendale (Station Id. 133), and Long Beach (Station Id. 174)

3. [www.cimis.water.ca.gov](http://www.cimis.water.ca.gov)

**Exhibit ES-E**  
**Historical Total Water Demand in LADWP's Service Area**



**Exhibit ES-F**  
**Breakdown in Historical Water Demand for LADWP's Service Area**

Fiscal Year	Single-Family		Multifamily		Commercial		Industrial		Government		Non-Revenue		Total
	AF	%	AF	%	AF	%	AF	%	AF	%	AF	%	
1986-90 Avg	238,248	35%	197,312	29%	123,324	18%	30,502	4%	43,378	6%	52,830	8%	685,594
1991-95 Avg	197,322	35%	177,104	31%	110,724	19%	21,313	4%	38,600	7%	24,100	4%	569,164
1996-00 Avg	222,748	35%	191,819	30%	111,051	18%	23,560	4%	39,830	6%	43,617	7%	632,626
2001-05 Avg	239,754	36%	190,646	29%	109,685	17%	21,931	3%	41,888	6%	58,299	9%	662,203
2005-10 Avg	236,154	38%	180,279	29%	106,955	17%	23,201	4%	42,940	7%	31,929	5%	621,458
25-yr Avg	226,845	36%	187,432	29%	112,348	18%	24,101	4%	41,327	6%	42,155	7%	634,209

**Historical Water Use**

Exhibit ES-E presents the historical water demand for LADWP. In 2009, an economic recession and a water supply shortage required LADWP to impose mandatory conservation. In 2010 mandatory conservation continued as the economic recession became more severe, resulting in a 19 percent decrease in water use.

Prior to 1990, population growth in Los Angeles was a good indicator of total demands. From 1980 to 1990, population in the City grew at 1.7 percent annually. Water demands during this same ten

year period also grew at 1.7 percent annually. However, after 1991, LADWP began implementing water conservation measures and water use efficiency programs which prevented water demands from returning to pre-1990 levels. Average water demands in the last five years from FY 2004/05 to 2009/10 are about the same as they were in FY1980/81 despite the fact that over 1.1 million additional people now live in Los Angeles.

Exhibit ES-F shows the breakdown in average total water use between LADWP's major billing categories and non-revenue water in five-year intervals for the past

25 years. Non-revenue water, which is the difference between total water use and billed water use, includes water for fire fighting, reservoir evaporation, mainline flushing, leakage from pipelines, meter error, and theft. Single-family residential water use comprises the largest category of demand in LADWP's service area, representing about 36 percent of the total. Multifamily residential water use is the next largest category of demand, representing about 29 percent of the total. Industrial use is the smallest category, representing only 4 percent of the total demand. Although total water use has varied substantially from year to year, the breakdown between the major billing categories of use has not.

In order to assess the potential for water use efficiency and target conservation programs, LADWP conducted an analysis to determine indoor and outdoor water uses for its major billing categories. The analysis concluded that the City's total outdoor water use was approximately 39 percent of the total water use during the study period from 2004 to 2007. (see Exhibit ES-G).

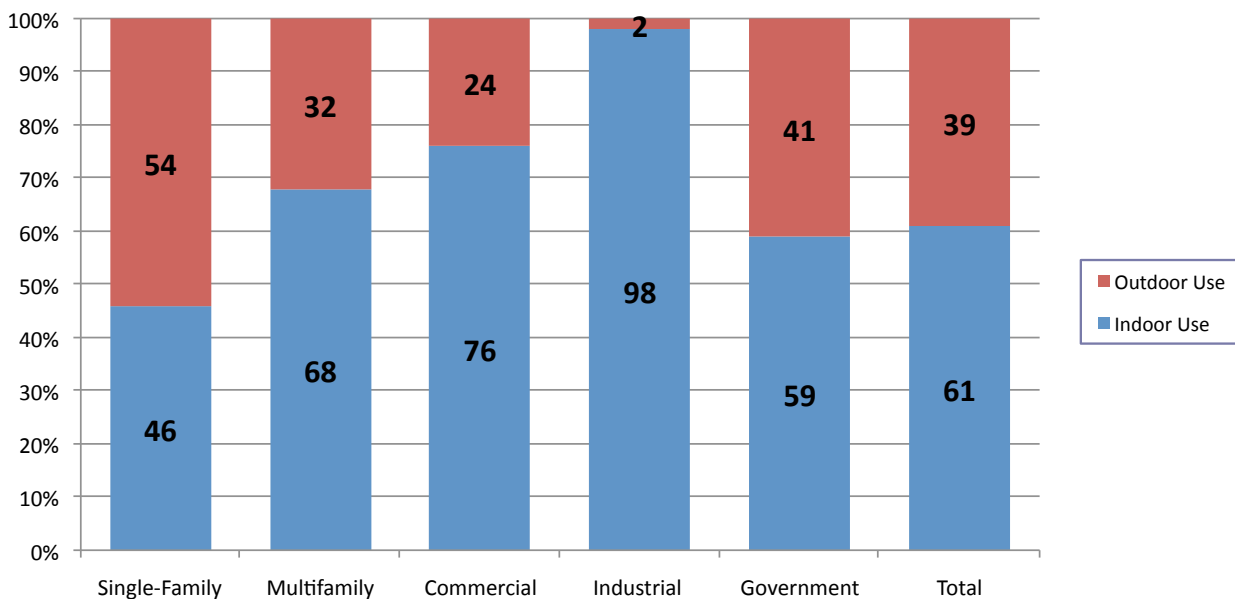
## Water Demand Forecast

Using an econometric water demand forecasting approach, LADWP projected water demands by major category and under different weather conditions. Exhibit ES-H presents the water demand forecast with and without future active water conservation programs.

Categorically, conservation can be grouped into two main types; active and passive conservation. Passive conservation accounts for the improved water use efficiency of retrofitted and new residential homes and commercial buildings due to plumbing code changes. The passive conservation due to the 1991 and 2010 plumbing code changes is hardwired into the 2010 water demand forecast model. Therefore, both cases of demand forecast on Exhibit ES-H are presented with the built-in passive conservation.

Examples of active conservation include installation of low-flush toilets and low flow plumbing fixtures, replacing turf with drought resistant landscaping, and programs which promote water use efficiency in industrial processes. The demand forecast model can present the

**Exhibit ES-G**  
**Indoor and Outdoor Water Use in LADWP's Service Area**



**Exhibit ES-H  
Water Demand  
Forecast and  
Conservation  
Savings Under  
Average  
Weather Fiscal  
Year Ending  
June 30 (Acre-  
Feet)**

Demand Forecast with Passive Water Conservation	2005	2010	2015	2020	2025	2030	2035
Single-Family		198,444	229,115	241,976	249,528	257,693	259,904
Multifamily		167,299	179,653	194,724	205,136	216,054	221,912
Commercial/Gov		135,000	143,081	149,597	153,791	158,628	160,049
Industrial		20,298	20,524	20,726	20,532	20,408	19,852
Non-Revenue		33,515	42,421	44,989	46,617	48,380	49,042
Total		554,556	614,794	652,012	675,604	701,164	710,760
Demand Forecast with Passive & Active Water Conservation	2005 Actual	2010 Actual	2015	2020	2025	2030	2035
Single-Family	233,192	196,500	225,699	236,094	241,180	246,879	247,655
Multifamily	185,536	166,810	178,782	193,220	202,999	213,284	218,762
Commercial/Gov	107,414	130,386	135,112	133,597	129,761	126,567	120,420
Industrial	62,418	19,166	18,600	16,852	14,708	12,634	10,513
Non-Revenue	26,786	32,909	41,370	42,969	43,627	44,421	44,272
Total	615,346	545,771	599,563	622,732	632,275	643,785	641,622
Aggregate Active Water Conservation Savings From	2005	2010	2015	2020	2025	2030	2035
Single-Family		1,944	3,416	5,882	8,349	10,815	12,249
Multifamily		489	871	1,504	2,137	2,770	3,150
Commercial/Gov		4,614	7,969	16,000	24,030	32,061	39,629
Industrial		1,132	1,924	3,874	5,824	7,774	9,339
Non-Revenue		606	1,051	2,020	2,990	3,959	4,771
Total		8,785	15,231	29,280	43,329	57,379	69,138

\* Non-revenue is the combination of unaccounted water and accounted non-revenue water. Unaccounted water is defined as system losses. In recent years, the City experienced no accounted non-revenue water. Thus, non-revenue water is considered system loss.

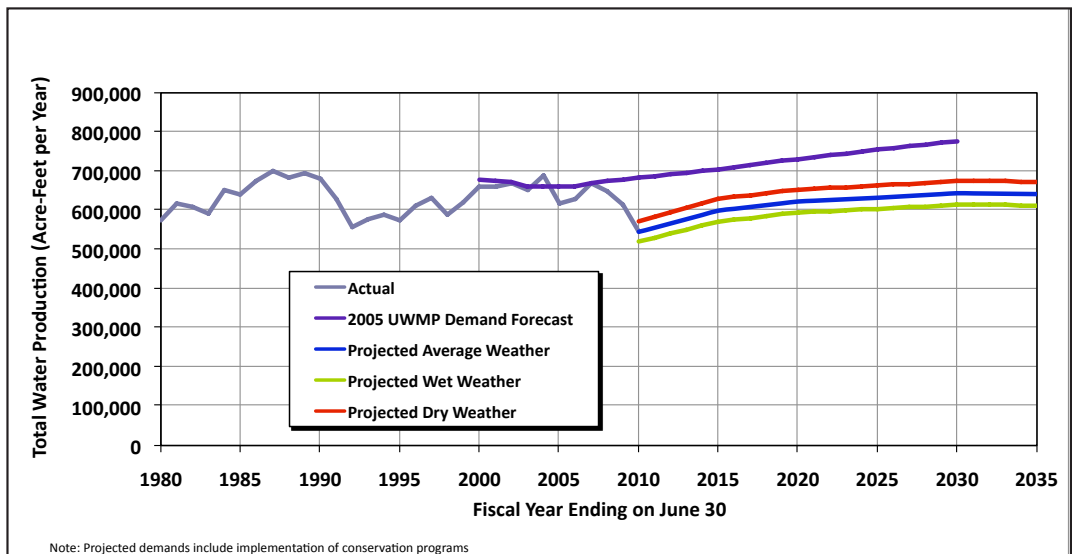
results with or without the additional active conservation planned after 2008. The active conservation prior to 2008 is considered a permanent part of the newly established water demand factors for the 2010 water demand forecast model and is accounted for in the forecast.

The calculated active conservation savings include the planned active conservation savings and the additional savings as a result of the decrease in non-

revenue water, which is proportional to the decrease of the total water demand.

Exhibit ES-I shows the projected water demands can vary by approximately ± 5 percent in any given year due to average historical weather variability. Historical water use from 1980 to 2010 is illustrated as actual water use. When comparing with the demands forecasted in the 2005 UWMP, the 2010 demand forecasts are about 15 percent lower.

**Exhibit ES-I  
LADWP Water Demand Forecast with Average Weather Variability**





## ES-4 Water Conservation

Los Angeles is a national leader in water use efficiency. This accomplishment has resulted from the City's sustained implementation of effective water conservation programs since the 1990s. One of LADWP's most effective conservation tools is its customer's water use efficiency ethic. During past water shortages, residents and businesses have aggressively implemented conservation to achieve demand reductions. During FY 2009/10, water use was below 1979 water use levels thanks to extraordinary conservation efforts by LADWP customers.

To measure conservation effectiveness, LADWP developed a statistical regression model that correlates total water use against population, weather, economic recession, and conservation. The model can predict what water use would be based on actual population, weather and economy in a given year, but without the conservation. The predicted water

use is then compared to actual water use and the difference between the two is the annual total water conservation/savings as shown in Exhibit ES-J. The exhibit summarizes LADWP's historical water conservation since FY 1990. The table shows water savings from hardware programs, such as ultra-low-flow and high-efficiency toilet retrofits, cooling tower recirculation, high efficiency clothes washer machines, and other plumbing and efficiency measures. The table also shows water savings that occur from non-hardware programs that result from changes in water customer behavior, such as reduced watering, and taking shorter showers. These behavioral conservation savings occur as a result of public education and information programs, and increases in the price of water. As shown in the exhibit, hardware water savings have been steadily increasing since 1990 while non-hardware water savings peaked in FY 1991/92 and again in FY 2009/10. The peaks in non-hardware savings were due to City of Los Angeles' mandatory water use restrictions implemented in response to multi-year water shortages.

### Exhibit ES-J Historical Water Conservation in LADWP's Service Area

Fiscal Year	Additional Annual Hardware Installed Savings (AF)	Cumulative Annual Hardware Savings (AF)	Annual Non-Hardware Savings (AF)	Annual Total Savings (AF)
Prior to 1990/1991	31,825	31,825		
1990/1991	4,091	35,916	76,350	112,267
1991/1992	8,670	44,586	105,593	150,179
1992/1993	3,286	47,872	58,546	106,417
1993/1994	4,961	52,832	60,928	113,761
1994/1995	4,041	56,873	62,084	118,958
1995/1996	4,642	61,516	52,648	114,164
1996/1997	2,376	63,892	33,720	97,612
1997/1998	2,637	66,529	30,434	96,964
1998/1999	2,781	69,310	38,305	107,614
1999/2000	3,532	72,842	-6,262	66,580
2000/2001	3,078	75,920	-3,407	72,513
2001/2002	2,452	78,371	15,131	93,502
2002/2003	2,630	81,002	8,725	89,726
2003/2004	3,257	84,259	13,107	97,366
2004/2005	3,299	87,558	46,865	134,423
2005/2006	2,404	89,963	62,223	152,186
2006/2007	2,095	92,058	76,643	168,701
2007/2008	782	92,840	64,472	157,312
2008/2009	3,127	95,967	106,151	202,118
2009/2010	4,269	100,236	126,466	226,702

1. Negative non-hardware savings are due to overestimation in hardware savings due to years with extreme wet weather conditions.

## Exhibit ES-K Active Water Conservation Projections

Sector	Acre-feet per Fiscal Year				
	2014/2015	2019/2020	2024/2025	2029/2030	2034/2035
Single-Family Residential	3,416	5,882	8,349	10,815	12,249
Multi-Family Residential	871	1,504	2,137	2,770	3,150
Commercial/Government	7,969	16,000	24,030	32,061	39,629
Industrial	1,924	3,847	5,824	7,774	9,339
Total Active Conservation Projections	14,180	27,260	40,340	53,420	64,368

### Water Conservation Goals

LADWP has set a water conservation goal to further reduce potable water demands an additional 64,000 AFY by 2035. This aggressive approach includes multiple strategies: investments in state-of-the-art technology; rebates and incentives promoting installation of weather-based irrigation controllers (WBICs), efficient clothes washers and urinals; expansion and enforcement of prohibited water use; reductions in outdoor water uses; and extending education and outreach efforts. Exhibit ES-K shows the projected water conservation by sector of use. Note that these projected savings are in addition to what has already occurred in the City since the 1990s.

The California Water Conservation Act of 2009, Senate Bill x7-7, requires water agencies to reduce per capita water use by 20 percent by the year 2020 (20x2020). This includes increasing recycled water use to offset potable water use. Water suppliers are required to set a water use target for 2020 and an interim target for 2015 using one of four methods. The 2020 urban water use target may be updated in a supplier's 2015 UWMP. The California Department of Water Resources (DWR) has developed four methods for measuring compliance with 20x2020.

LADWP has selected Method 3 to set its 2015 interim and 2020 water use targets. Method 3 requires setting the 2020 water use target to 95 percent of the applicable State hydrologic region target as provided in the State's Draft 20x2020 Water Conservation Plan. LADWP is

within State hydrologic region 4, the South Coast region. LADWP was required to further adjust the calculated 2020 target to achieve a minimum reduction in water use. The per capita water use at 95 percent of the hydrologic region was 142 gallons per capita per day (gpcd), and using 95 percent of the five-year average base daily per capita water use was equal to 138 gpcd. Therefore, LADWP was required to set its 2020 target at the smaller of the two resultant values. LADWP's interim 2015 target is 145 gpcd and the 2020 target is 138 gpcd. Exhibit ES-L presents the calculations for LADWP's 20x2020 target. Also shown in this exhibit for reference is LADWP's 10-year and 5-year historical average per capita water use.

### Exhibit ES-L 20x2020 Base and Target

20x2020 Required Data	Gallons Per Capita Per Day (GPCD)
<b>Base Per Capita Daily Water Use</b>	
10-Year Average <sup>1</sup>	152
5-Year Average <sup>2</sup>	145
<b>2020 Target Using Method 3<sup>3</sup></b>	
95% of Hydrologic Region Target (149 gpcd)	142
95% OF Base Daily Capita Water Use 5-Year Average (145 gpcd)	138
<b>Actual 2020 Target</b>	<b>138</b>
<b>2015 Interim Target</b>	145

1. Ten-year average based on fiscal year 1995/96 to 2004/05

2. Five-year average based on fiscal year 2003/04 to 2007/08

3. Methodology requires smaller of two results to be actual water use target to satisfy minimum water use target.

**Exhibit ES-M**  
**Water Conservation BMPs and Implementation Status**

Category	Sub-category	Practices	Status
<b>Foundational</b>			
Utility Operations	Operations Practices	Maintain the position of a trained conservation coordinator	Implemented
		Prevent water waste – enact, enforce or support legislation, regulations, and ordinances	Implemented
		Wholesale agency assistance programs	Not applicable
	Water Loss Control	Conduct Standard Water Audit and Water Balance	Implemented
		Measure performance using AWWA software	Implemented
		Locate and Repair all leaks and breaks	Implemented
	Metering with Commodity Rates	100% of existing unmetered accounts to be metered and billed by volume of use	Implemented
Conservation Pricing	Maintain a water conserving retail rate structure	Implemented	
Education	Public Information Programs	Maintain active public information program to promote and educate customers about water conservation	Implemented
	School Education Programs	Maintain active program to educate students about water conservation and efficient water use	Implemented
<b>Programmatic</b>			
Residential		Residential Assistance – provide leak detection assistance	Implemented
		Landscape Water Surveys for residential accounts	Implemented
		High efficiency clothes washer incentive program	Implemented
		WaterSense Specification (WSS) for toilets	Implemented
Commercial/ Industrial/ Institutional (CII)		Implement unique conservation programs to meet annual water savings goals for CII customers	Implemented
Landscape		Implement Large Landscape custom programs	Implemented
		Offer technical assistance and surveys upon request	Implemented
		Implement and maintain incentive program(s) for irrigation equipment retrofits	Implemented

## Water Conservation Best Management Practices (BMPs)

LADWP is one of the original signatories to the California Urban Water Conservation Council Memorandum of Understanding (MOU), and as such has to report its progress on achieving water conservation BMPs. Exhibit ES-M presents the checklist of BMPs that LADWP has implemented. LADWP is currently in compliance with all the BMP's contained in the MOU.

## ES-5 Future Water Supplies

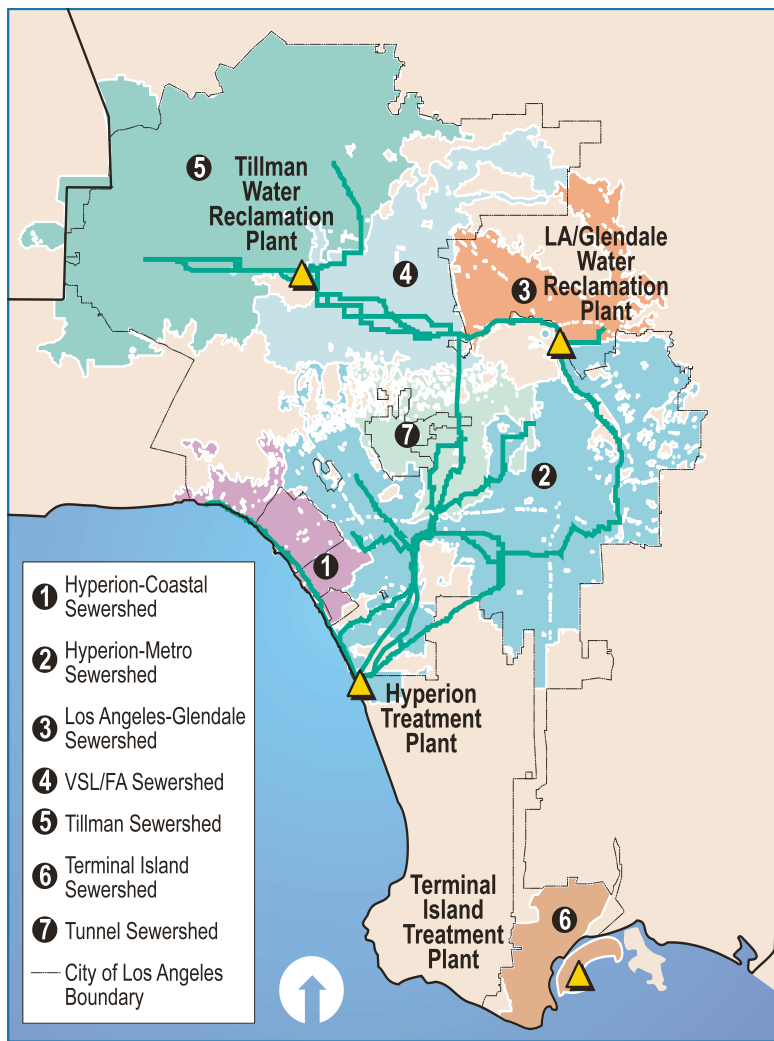
As stated previously, the water management goal of LADWP is to implement cost-effective conservation, recycled water, and stormwater capture programs. In addition, LADWP is also pursuing water transfers in order to make up for its LAA water losses.

### Water Recycling

LADWP is committed to significant expansion of recycled water in the City's water supply portfolio. Realizing multiple factors are decreasing the reliability of imported water supplies, LADWP released the City of Los Angeles Water Supply Action Plan (Plan), "Securing L.A.'s Water Supply" in May of 2008. The Plan established the goal of using 50,000 AFY of recycled water to offset demands on potable supplies. In order to meet this goal, LADWP, in conjunction with the Department of Public Works Bureau of Sanitation (BOS), are working together to develop a Recycled Water Master Plan (RWMP). Opportunities to expand the water recycling program are being studied through development of the RWMP. These include expanding the recycled water distribution system for Non-Potable Reuse (NPR) such as for irrigation and industrial use, along with replenishment of groundwater basins with highly purified recycled water. Beyond 50,000 AFY, LADWP expects to increase recycled water use by approximately 1,500 AFY annually, bringing the total to 59,000 AFY by 2035.

LADWP's water recycling program is dependent on the City's wastewater treatment infrastructure. Wastewater in the City of Los Angeles is collected and transported through some 6,500 miles of major interceptors and mainline sewers, more than 11,000 miles of house-sewer connections, 46 pumping plants, and four treatment plants. BOS is responsible for the planning and operation of the wastewater program. The City's wastewater system serves 515 square miles, of which 420 square

**Exhibit ES-N**  
**City Wastewater Plants and Sewersheds**



miles are within the City. In addition to the City, service is provided to 29 non-City agencies through contract services. Exhibit ES-N shows the City's four wastewater treatment plants and seven sewersheds that feed those plants. A portion of the treated effluent from the wastewater plants is utilized by LADWP to meet recycled water demands.

In FY 2009/10, LADWP provided 31,872 AFY of recycled water for municipal & industrial purposes and environmental benefits.

The use of recycled water must meet California's regulatory requirements for safety. Non-potable water reuse (NPR) regulations in the City of Los Angeles are governed by the California Department of Public Health (CDPH), State Water Resources Control Board (SWRCB), Los Angeles Regional Water Quality Control Board (LARWQCB) and the Los Angeles County Department of Public Health (LACDPH). Criteria and guidelines for the production and use of recycled water were established by the CDPH in the California Code of Regulations, Title 22, Division 4, and Chapter 3 (Title 22). Title 22, also known as Water Recycling Criteria, establishes required wastewater

treatment levels and recycled water quality levels dependent upon the end use of the recycled water. Title 22 additionally establishes recycled water reliability criteria to protect public health.

The regulations governing recharge of groundwater or groundwater replenishment (GWR) with recycled water are established by the CDPH and LARWQCB. For groundwater replenishment, LADWP will implement advanced treatment that includes reverse osmosis, microfiltration, and advanced oxidation. This level of treatment will address water quality concerns for the health of the basin along with emerging contaminants of concern.

Exhibit ES-O presents LADWP's projected recycled water use based on preliminary findings from the RWMP.

### Stormwater Capture

The 2010 UWMP projects that the stormwater capture can potentially provide increased groundwater pumping rights in the San Fernando Basin of 15,000 AFY from groundwater recharge using captured stormwater, and 10,000 AFY of additional water conservation from

### Exhibit ES-O Recycled Water Use Projections

Category	Projected Use (AFY) <sup>1</sup>				
	2015	2020	2025	2030	2035
Municipal and Industrial Non-Potable Reuse	20,000	20,400	27,000	29,000	29,000
Indirect Potable Reuse (Groundwater Recharge)	0	0	15,000	22,500	30,000
<b>Subtotal<sup>2</sup></b>	<b>20,000</b>	<b>20,400</b>	<b>42,000</b>	<b>51,500</b>	<b>59,000</b>
Environmental <sup>3</sup>	26,990	26,990	26,990	26,990	26,990
Seawater Intrusion Barrier (Dominguez Gap Barrier)	3,000	3,000	3,000	3,000	3,000
<b>Total</b>	<b>49,990</b>	<b>50,390</b>	<b>71,990</b>	<b>81,490</b>	<b>88,990</b>

1. Projected use by category is subject to change per completion of Recycled Water Master Plan, but overall total will not change. Does not include deliveries of 34,000 AFY of secondary treated water to WBMWD for further treatment to recycled water standards.

2. To offset potable use and included in supply reliability tables in Chapter 11.

3. Environmental use includes Wildlife Lake, Balboa Lake, and the Japanese Garden. Additional environmental benefits associated with recycled water discharges to the Los Angeles River are not included.

## Exhibit ES-P Planned Centralized Stormwater Capture Programs

Project	Current Annual Recharge (AFY)	Increased Annual Capture/ Recharge (AFY)	Expected Annual Recharge (AFY)	Estimated Project Completion	Total Project Cost (millions)	LADWP Share (millions)
Sheldon-Arleta Gas Collection System	-	4,000 <sup>(1)</sup>	-	Completed Nov 2009	\$8.2	\$6.3
Big Tujunga Dam Rehabilitation <sup>(3)</sup>	-	4,500	-	July 2011	\$105.7	\$9.0
Hansen Spreading Grounds Upgrade	13,834	1,200	17,284 <sup>(2)</sup>	Dec 2011	\$9.3	\$4.8
Tujunga Spreading Grounds Upgrade	4,419	8,000	18,669 <sup>(4)</sup>	2015	\$24.0	\$24.0
Pacoima Spreading Grounds Upgrade	6,453	2,000	8,453	2015	\$32.0	\$16.0
Lopez Spreading Grounds Upgrade	527	750	1,277	2016	\$8.0	\$4.0
Strathern Wetlands Park	-	900	900 <sup>(5)</sup>	2016	\$46.0	\$4.0
Hansen Dam Water Conservation	-	3,400	3,400	2017	\$5.0	\$2.5
Valley Generating Station Stormwater Capture	-	700	700	2018	\$9.7	\$9.7
Branford Spreading Basin Upgrade	549	500	1,049	2018	\$4.0	\$2.0
<b>Total Estimated Yield</b>	<b>25,782</b>	<b>25,950</b>	<b>51,732</b>		<b>\$251.9</b>	<b>\$82.3</b>

1. This will allow increased collection of 4,000 AFY at Tujunga Spreading Grounds.
2. Includes 1/2 benefits from Big Tujunga Dam Rehabilitation Project.
3. No recharge occurs at the facility. All additional capture has been divided between Hansen & Tujunga Spreading Grounds.
4. Including benefits from Sheldon-Arleta Project and 1/2 benefits from Big Tujunga Dam Rehabilitation Project.
5. To be recharged at Sun Valley Park.

capture and reuse solutions such as rain barrels and cisterns, for a total of 25,000 AFY by FY 2034/35. A Stormwater Capture Master Plan is being prepared and will comprehensively evaluate stormwater capture potential within the City.

In January 2008, LADWP created the Watershed Management Group which is responsible for developing and managing the water system's involvement in emerging issues associated with local and regional stormwater capture. The Watershed Management Group coordinates activities with other agencies, departments, stakeholders and community groups for the purpose of planning and developing projects and initiatives to improve stormwater management within the City. The Group's primary goal is to increase stormwater capture by enhancing existing centralized stormwater capture facilities and

promoting distributed stormwater infiltration systems to achieve the City's long-term strategy of enhancing local stormwater capture.

Watershed management provides additional important benefits to the City of Los Angeles, including surface water quality improvements, water conservation, open space enhancements, and flood control. Water quality improvements are necessary because stormwater runoff is a conveyance mechanism that transports pollutants from the watershed into waterways and ultimately the Pacific Ocean. Pollutants include, but are not limited to, bacteria, oils, grease, trash, and heavy metals. The City must comply with adopted Total Maximum Daily Loads (TMDLs) for pollutants. TMDLs set maximum limits for a specific pollutant that can be discharged to a water body without causing the water

body to become impaired or limiting certain uses.

LADWP has already been implementing several watershed projects and has identified others for planned implementation. Exhibit ES-P summarizes the currently planned watershed projects.

The Stormwater Capture Master Plan (Stormwater Plan) is being prepared to investigate potential strategies for stormwater and watershed management in the City. The Stormwater Plan will be used to guide decision makers in the City when making decisions affecting how the City will develop both centralized and distributed stormwater capture goals. The Stormwater Plan will evaluate existing stormwater capture facilities and projects, quantify the maximum stormwater capture potential, develop feasible stormwater capture alternatives (i.e., projects, programs, potential policies, etc.), and provide strategies to increase stormwater capture. It will also evaluate the multi-beneficial aspects of increasing stormwater capture, including potential open space alternatives, improved downstream water quality, and peak flow attenuation in downstream channels, creeks, and streams such as the Los Angeles River.

## **Water Transfers**

Water transfers involve the lease or sale of water or water rights between consenting parties. Water Code Section 470 (The Costa-Isenberg Water Transfer Act of 1986) states that voluntary water transfers between water users can result in a more efficient use of water, benefiting both the buyer and the seller. The State Legislature further declared that transfers of surplus water on an intermittent basis can help alleviate water shortages, save capital outlay development costs, and conserve water and energy. This section of the Water Code also obligates the California Department of Water Resources (DWR) to facilitate voluntary exchanges and transfers of water.

LADWP plans on acquiring water through transfers to replace a portion of LAA water used for environmental enhancements in the eastern Sierra Nevada. The City would purchase water when available and economically beneficial for storage or delivery to LADWP's transmission and distribution system. The City is seeking non-State Water Project water to replace the reallocation of LAA water supply for environmental enhancements. MWD holds an exclusive contractual right to deliver State Water Project entitlement water into its service territory, which includes the City of Los Angeles. Purchasing only non-State Water Project supplies will ensure the City's compliance with MWD's State Water Project contract.

To facilitate water transfers, LADWP is constructing an interconnection between the LAA and the State Water Project's California Aqueduct, located where the two aqueducts intersect in the Antelope Valley (Neenach, California). This interconnection, the Neenach Pumping Station will allow for water transfers from the East Branch of the State Water Project to the LAA System, as well as provide operational flexibility in the event of a disruption of flows along the LAA System. Construction of the Neenach Pumping Station required a four-way agreement between DWR, MWD, LADWP, and the Antelope Valley-East Kern Water Agency (AVEK). When completed, the Neenach Pumping Station facility will be owned by DWR but will be designated as an AVEK interconnection. The Neenach Pumping Station will be operated on behalf of the LADWP. MWD is involved in the agreement to provide consent for the transfer of water into its service territory.

LADWP's current goal is to transfer up to 40,000 AF per year once the Neenach Pumping Station facilities are in place. This will provide LADWP with the ability to replace some Los Angeles Aqueduct supplies reallocated to environmental enhancement projects. This will also provide increased operational flexibility and the ability to yield cost savings.



## Other Water Supply Opportunities

### Seawater Desalination

LADWP initiated efforts in 2002 to evaluate seawater desalination as a potential water supply source with the goals of improving reliability and increasing diversity in its water supply portfolio. These efforts led to the selection of the Scattergood Generating Station's unused tank farm as a potential site for a seawater desalination plant. For the City, seawater desalination is a potential resource that could also offset supplies that had been committed from the LAA for environmental restoration in the eastern Sierra Nevada. As an identified project in MWD's Seawater Desalination Program, the proposed full-scale project would have qualified for MWD's grant of \$250 per acre-foot of water produced. However, in May 2008, LADWP decided to focus on water conservation and water recycling as primary strategies for creating a sustainable water supply due to concerns with cost and the environmental impacts

associated with the implementation of desalination. While desalination may be explored further in the future, it currently represents only a supply alternative.

### Graywater Systems

As defined by State regulations, graywater is untreated household wastewater which has not come into contact with toilet waste or unhealthy bodily wastes. It includes water sources from bathtubs, showers, bathroom wash basins, and water from clothes washing machines and laundry tubs. It specifically excludes water from kitchen sinks and dishwashers. Graywater is a drought-proof source of supply for subsurface landscape irrigation. Graywater regulations do not allow its application using spray irrigation. Graywater is also not allowed to pond or runoff, enter a storm drain system or surface water body, or irrigate root crops or edible food crops that are directly in contact with the surrounding soil.

The Graywater Systems for Single Family Residences Act of 1992 legally incorporated the use of graywater as part of the California Plumbing Code. In September 1994, the City approved an ordinance that permitted the installation of graywater systems in residential homes. However, installing graywater systems under the Act was costly in terms of both installation and maintenance. To address the current water shortage and reduce water demands, emergency graywater regulations added Chapter 16A (Part I) "Non-potable Water Reuse Systems" to the 2007 California Plumbing Code. These regulations were approved by California Building Standards Commission in 2009 and became effective on August 4, 2009. Further revisions were made to the regulations and the regulations became permanent on January 12, 2010 with an effective date of January 20, 2010. These new code changes allow the use of certain types of untreated graywater systems as long as specific health requirements are met as defined by the authority having jurisdiction.



## ES-6 Water Supply Reliability

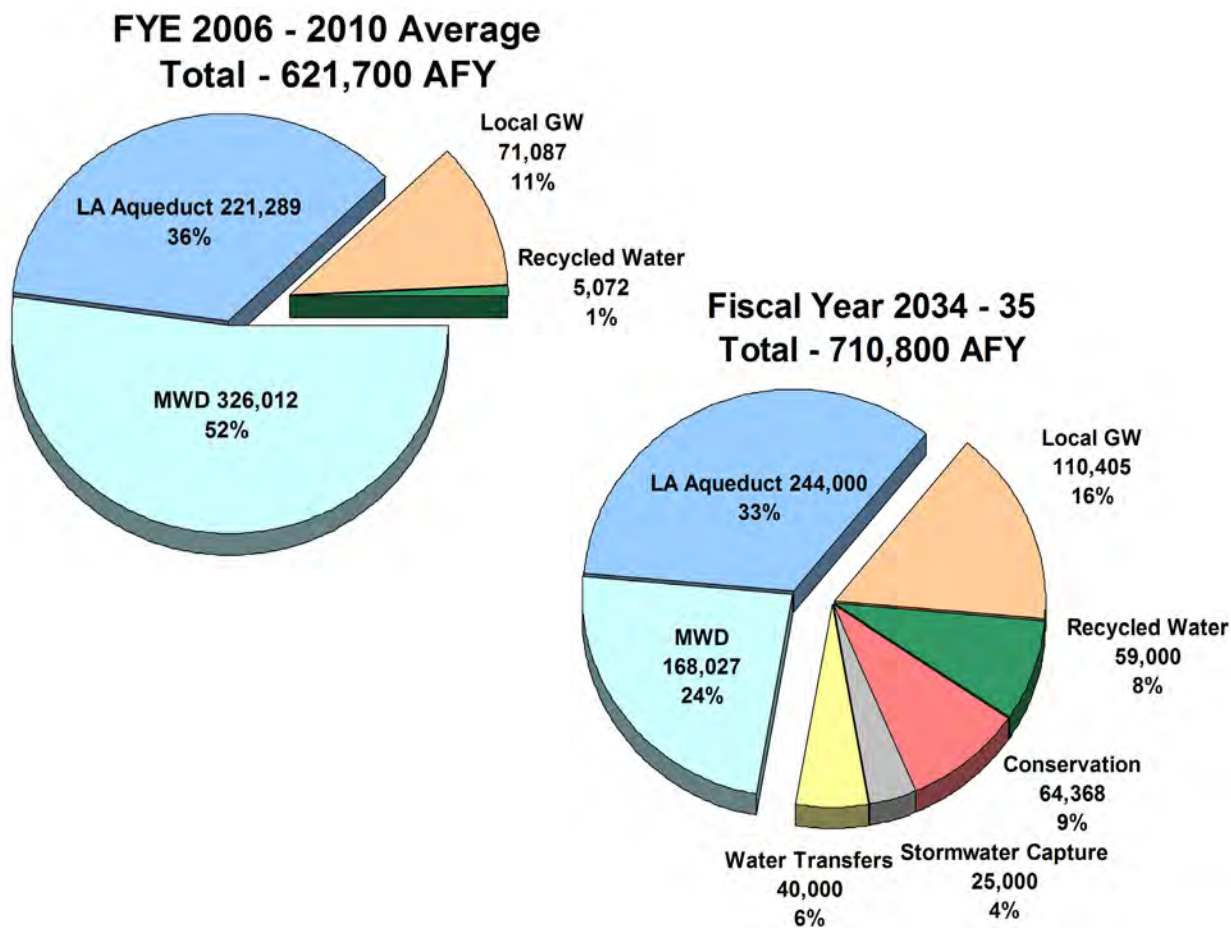
With its current water supplies, planned future water conservation, and planned future water supplies, LADWP will be able to reliably provide water to its customers through the 25-year planning period covered by this UWMP. While there may be times in which severe water shortages require MWD to allocate its imported water in the future, LADWP's customers have shown that they can adapt and reduce consumption in those years. However, MWD's 2010 Regional UWMP currently shows that with its investments in storage, water transfers and improving the reliability of the Delta,

water shortages are not expected to occur within the next 25 years.

Exhibit ES-Q shows the current and future mix of LADWP's water supply. As shown in this exhibit, local water supplies and new water conservation are projected to increase from the current 12 percent to 43 percent by 2035. This increased local supply mix will allow LADWP to reduce by half its MWD water supply purchases, effectively making LADWP less subject to cost increases on purchased water. The focus on local supplies also increases flexibility and overall reliability, particularly during periods of water shortage.

### Exhibit ES-Q Current and Projected Mix of LADWP's Water Supplies

Note: Charts do not reflect approximately 100,000 AF of existing conservation



## Supply Reliability Assessment

To demonstrate LADWP's water supply reliability, Exhibit ES-R summarizes the water demands and supplies for an average weather year through 2035.

Exhibit ES-S presents the supply reliability for the driest three-year sequence from 2010 to 2013, as required by the UWMP guidelines.

## Water Quality Issues

Water quality is an important and necessary consideration in all impact water management strategies and supply reliability. For example as shown in Footnote 2 of the Exhibit ES-R, the sustainability of the groundwater production is contingent on completing two groundwater treatment facilities for the San Fernando Basin groundwater. Similarly, the effectiveness of expanding

### Exhibit ES-R Service Area Reliability Assessment for Average Weather Year

Demand and Supply Projections (in acre-feet)	FY2009-10 Actual	Average Weather Conditions (FY 1956/57 to 2005/06) Fiscal Year Ending on June 30				
		2015	2020	2025	2030	2035
<b>Total Demand</b>	<b>555,477</b>	<b>614,800</b>	<b>652,000</b>	<b>675,600</b>	<b>701,200</b>	<b>710,800</b>
<b>Existing / Planned Supplies</b>						
Los Angeles Aqueduct <sup>1</sup>	199,739	252,000	250,000	248,000	246,000	244,000
Groundwater <sup>2</sup>	76,982	40,500	96,300	111,500	111,500	110,405
Conservation	8,178	14,180	27,260	40,340	53,419	64,368
Recycled Water						
- Irrigation and Industrial Use	6,703	20,000	20,400	27,000	29,000	29,000
- Groundwater Replenishment	0	0	0	15,000	22,500	30,000
Water Transfers	<u>0</u>	<u>40,000</u>	<u>40,000</u>	<u>40,000</u>	<u>40,000</u>	<u>40,000</u>
Subtotal	291,602	366,680	433,960	481,840	502,419	517,773
<b>MWD Water Purchases With Existing/Planned Supplies</b>	263,875	248,120	218,040	193,760	198,781	193,027
<b>Total Supplies</b>	<b>555,477</b>	<b>614,800</b>	<b>652,000</b>	<b>675,600</b>	<b>701,200</b>	<b>710,800</b>
<b>Potential Supplies</b>						
Stormwater Capture						
- Capture and Reuse (Harvesting)	0	2,000	4,000	6,000	8,000	10,000
- Increased Groundwater Production (Recharge)	<u>0</u>	<u>0</u>	<u>2,000</u>	<u>4,000</u>	<u>8,000</u>	<u>15,000</u>
Subtotal	0	2,000	6,000	10,000	16,000	25,000
MWD Water Purchases With Existing/Planned/Potential Supplies	263,875	246,120	212,040	183,760	182,781	168,027
<b>Total Supplies</b>	<b>555,477</b>	<b>614,800</b>	<b>652,000</b>	<b>675,600</b>	<b>701,200</b>	<b>710,800</b>

<sup>1</sup> Los Angeles Aqueduct supply is estimated to decrease 0.1652% per year due to climate change impact.

<sup>2</sup> North Hollywood/Rinaldi-Toluca Treatment Complex is expected in operation in 2019-20. Tujunga Groundwater Treatment Plant is expected in operation in 2020-21. Storage credit of 5,000 afy will be used to maximize the pumping in 2020-21 and thereafter. Sylmar Basin production was increased to 4,500 AFY from 2014-15 to 2029-30 to avoid the expiration of stored water credits, then go back to its entitlement of 3,405 AFY in 2030-31.

**Exhibit ES-S  
Driest Three-Year Water Supply Sequence**

Demand and Supply Projections (in acre-feet)	FY2009-10 Actual	Followed by Repeat of Driest Three Consecutive Years FY 1958/59 to 1960/61 Hydrology Fiscal Year Ending on June 30		
		2011	2012	2013
<b>Total Demand</b>	<b>555,477</b>	<b>590,000</b>	<b>608,200</b>	<b>626,500</b>
<b>Existing / Planned Supplies</b>				
Los Angeles Aqueduct <sup>1</sup>	199,739	104,530	50,849	59,382
Groundwater <sup>2</sup>	76,982	61,090	53,660	46,260
Conservation	8,178	9,380	10,580	11,780
Recycled Water				
- Irrigation and Industrial Use	6,703	7,500	8,300	9,000
- Groundwater Replenishment	0	0	0	0
Water Transfers	0	0	0	0
Subtotal	291,602	182,500	123,389	126,422
<b>MWD Water Purchases With Existing/Planned Supplies</b>	263,875	407,500	484,811	500,078
<b>Total Supplies</b>	<b>555,477</b>	<b>590,000</b>	<b>608,200</b>	<b>626,500</b>

1. Driest three consecutive years on record in LAA watershed (FY1958-59 to FY1960-61) averaged 28 percent of normal runoff.
2. LAA deliveries reflect increased releases for environmental restoration in the Owens Valley and Mono Basin.
3. Dry year demands are 5 percent greater than normal year demands
4. MWD's Water Surplus and Drought Management Plan actions sufficient to meet LADWP demands.

the use of the San Fernando Basin groundwater from recycled water and captured stormwater also depends on implementation of treatment.

In the portions of the eastern San Fernando Basin, we have detected several industrial contaminants. These include trichloroethylene (TCE), perchloroethylene (PCE), hexavalent chromium, perchlorate and other volatile organic compounds (VOCs). These contaminants are a result of historical improper chemical disposal in the San Fernando Valley. Nitrates in the San Fernando Basin is an additional contaminant of concern which is the result of decades of agricultural activities. These contaminants threaten the overall reliability and sustainability of the City's groundwater supply. LADWP is determined to address the contamination in order to continue to provide high quality water. In this effort, LADWP is

working with local, state and federal agencies such as the U.S. Environmental Protection Agency, the California Department of Public Health, the Los Angeles Regional Water Quality Control Board, and the California Department of Toxic Substances Control. LADWP has an ongoing extensive groundwater monitoring program to ensure that groundwater pumping occurs from the safer areas of the basin. LADWP has shutdown groundwater pumping from highly contaminated regions. This has resulted in a 40 percent reduction in pumping from the San Fernando Basin. LADWP has embarked on an ambitious and comprehensive undertaking to address this groundwater contamination. It has begun with a \$19 million Groundwater System Improvement Study (GSIS) that will provide vital information to assist with developing both short and long-term projects to maximize the restore the City's historical groundwater

usage from the San Fernando Basin. This includes installing additional monitoring wells to help identify contaminants and the best technologies to treat them. The pace of implementation of treatment will be subject to necessary approvals and availability of funding. Already some wellfield treatment projects are underway in partnership with the U.S. Environmental Protection Agency, Metropolitan Water District of Southern California and others.

LADWP closely monitors water quality issues regarding source water challenges and proposed regulations at the local, state and federal levels. LADWP also proactively researches and invests in advanced and emerging technologies to ensure continued safety and reliability of the City's water supplies. A recent example of LADWP's regulatory diligence is addressing the Stage 2 Disinfectants and Disinfection Byproduct Rule with the conversion from chlorine to chloramine as the City's secondary disinfectant. Studies have shown that chlorine tends to increase levels of disinfection byproducts such as trihalomethanes (THMs) and haloacetic acids (HAAs). While still protective, chloramine is significantly less reactive and forms lesser levels of THMs and HAAs. LADWP is planning to complete the conversion from chlorine to chloramine by April 2014.

Similarly, LADWP is closely monitoring level of naturally occurring arsenic in the LAA supply. Although the levels of arsenic in the water served is on average 3.3 parts per billion (ppb) and is well below the current federal and state drinking water standard of 50 ppb. LADWP is committed to continuing research to develop strategies to further reduce the levels of arsenic in its water supply.

LADWP continuously strives to surpass the water quality standards and requirements and do so in an effective and affordable way for our customers. By managing state-of-the-art water treatment process, maintaining and operating treatment facilities, and vigilantly monitoring and testing the water

we serve, LADWP has been meeting or exceeding all health-based drinking water standards. The drinking water standards are set by the U.S. Environmental Protection Agency and the California Department of Public Health.



## Global Climate Change

LADWP is considering impacts of climate change during development of its long-term water supply plan. Climate change is a global-scale concern, but is particularly important in the western United States where potential impacts on water resources can be significant to supplies for water agencies. Climate change can impact surface supplies from the LAA, imported supplies from MWD, and local demands. As a result, LADWP completed a study to analyze the operational and water supply impacts of potential shifts in the timing and quantity of runoff along the LAA system due to climate change in the 21st Century. Such potential shifts may require LADWP to develop, enhance, and modify management of local water resources. Projected changes in climate are expected to alter hydrologic patterns in the Eastern Sierra through changes in

precipitation, snowmelt, relative ratios of rain and snow, and runoff.

To understand some of the key issues surrounding climate change impacts, it is important to put it into the context of LADWP's water supplies. California lies within multiple climate zones. Therefore, each region will experience unique impacts to climate change. Because LADWP relies on both local and imported water sources, it is necessary to consider the potential impacts climate change could have on the local watershed as well as the western and eastern Sierra Nevada watersheds where a portion of MWD's imported water originates and LADWP's imported LAA supplies originate, respectively, and the Colorado River Basin where the remainder of MWD's imported supplies originate. Generally speaking, any water supplies that are dependent on natural hydrology are vulnerable to climate change, especially if the water source originates from mountain snow pack. For LADWP, the most vulnerable water sources subject to climate change impacts are imported water supplies from MWD and the LAA. In addition to water supply impacts, changes in local temperature and precipitation are expected to alter water demand patterns.

The LAA is one of the major imported water sources delivering a reliable water supply to the City of Los Angeles. The LAA originates approximately 340 miles away from snowmelt runoff in the eastern Sierra Nevada; hence LAA is subject to hydrologic variability associated with climate change. Since the majority of precipitation occurs during winter in the eastern Sierra Nevada watershed, water is stored in natural reservoirs in the form of snowpacks, and is gradually released into streams that feed into the LAA during spring and summer. Higher concentrations of greenhouse gases in the atmosphere are often indications of pending climate change. These changes threaten the hydrologic stability of the eastern Sierra Nevada watershed through alterations in precipitation, snowmelt, relative ratios of rain and snow, winter

storm patterns, and evapotranspiration, all of which have major potential impacts on the LAA water supply and deliveries.

LADWP's climate change study evaluated the potential impacts of climate change on the eastern Sierra Nevada watershed and the LAA water supply and deliveries. In this study, future climate conditions were predicted using a set of sixteen global climate models and two greenhouse gas emission scenarios. Results of the study show steady temperature increases throughout the 21st century and are consistent with other prior studies performed in the scientific community. Temperature is the main climate variable that is projected to rise significantly in the coming years and this rise in temperature directly affects several variables including:

- Whether precipitation falls as snow or rain.
- The ground-level temperature determines the timing and rate of snowmelt.
- The temperature profile that determines the rate of evapotranspiration.

Results have shown that future predictions for the early-21st century suggested a warming trend of 0.9 to 2.7 °F and almost no change in average precipitation. Mid-21st century projections suggested a warming trend of 3.6 to 5.4 °F and a small average decrease in precipitation, approximately 5 percent. This warming trend is expected to increase significantly by the end of 21st century, as the results suggest further warming of 4.5 to 8.1 °F and a decrease in precipitation of approximately 10 percent. Projected changes in temperature (warmer winters) will change precipitation patterns to rain with larger fractions than historically encountered. Consequently, peak Snow Water Equivalent (SWE) and runoff are projected to undergo a shift in timing to earlier dates.

**Exhibit ES-T  
Projected Runoff, Snow-Water Equivalent, and Rain-to-Snow Ratio for Eastern Sierra Nevada Watershed**

	<b>Runoff (MAF)</b>	<b>April 1 SWE (Inches)</b>	<b>Rain/Snow Ratio</b>
<b>Baseline (Second Half of 20<sup>th</sup> Century)</b>	<b>0.6</b>	<b>15.0</b>	<b>0.2</b>
<b>Early 21st-century (2010-2039)</b>	0.5 - 0.85	10.6 - 19.0	0.24 - 0.33
<b>Mid-century (2040-2069)</b>	0.34 - 0.9	7.0 - 19.7	0.25 - 0.43
<b>End-of-century (2070-2099)</b>	0.35 - 1.1	5.0 - 16.0	0.28 - 0.54

Exhibit ES-T summarizes the projections for runoff, SWE, and rain-to-snow ratio for the 21st century. The projected temperature and precipitation dataset form the basis of the hydrologic model projections for runoff, snow-water equivalent (SWE), and rain-to-snow ratio. To compare the future projections of these variables, the trends that dominated the second half of the 20th century are considered baselines for future trends. The baseline values for runoff, SWE, and rain-to-snow ratio are 0.6 million acre-feet (MAF), 15 inches, and 0.2, respectively. By Early 21st century (2010 – 2039), results illustrate runoff is projected to undergo increases and decreases averaging between 0.5 to 0.85 MAF; SWE is projected to undergo decreases and increases ranging between 10.6 to 19.0 inches, and the rain-to-snow ratio is projected to increase between 0.24 to 0.33. By mid-century (2040 – 2069), the same trends are expected to dominate, with runoff ranging between 0.34 to 0.9 MAF, SWE ranging between 7.0 to 19.7 inches, and the rain-to-snow ratio increasing between 0.25 to 0.43. These trends are expected to govern until the end-of-century (2070 -2099) with runoff ranging between 0.35 to 1.1 MAF, SWE ranging between 5.0 to 16.0 inches, and rain-to-snow ratio increasing between 0.28 to 0.54.

It is important to acknowledge that the predictions of global climate models lack the desired precision due to the presence

of uncertainties inherent in the analyses. The uncertainty to future emissions of greenhouse gases and the chaotic nature of the climate system leads to uncertain response of the global climate system to the increases in greenhouse gases. In addition, the science of climate change still lacks the complete understanding of regional manifestations that will result from global changes, thus restraining the projecting capacity of these models. However, these projections are consistent with the state of science today, and they help predict the manner of which hydrologic variables are likely to respond to a range of possible future climate conditions, and thus help to guide water managers in their planning and development efforts to ensure the reliability and sustainability of adequate water supply and delivery.

## **ES-7 Financing**

The UWMP also addresses financing issues associated with providing a reliable water supply. To fund future water conservation, recycled water, and stormwater programs, LADWP will utilize the following funding sources:

- Water Rates – An existing component of water rates currently provide approximately \$100 million annually for water conservation, water

recycling, and stormwater capture programs. It is anticipated that the water conservation, water recycling, and stormwater capture goals of the UWMP can be met with current levels of expenditures. State and/or federal funding will offset LADWP revenues, or allow goals to be achieved sooner than projected. In order to accomplish the UWMP goals related to treatment of contaminated groundwater supplies it will be necessary to increase current levels of expenditure, which will require an increase in water rates.

- MWD – Currently provides funding up to \$250 per AF for water recycling through their Local Resources Program. MWD also provides some water conservation incentive funding through rebates equal to \$195 per AF of water saved or half the product cost whichever is less.
- State Funds – Funds for recycling, conservation, and stormwater capture have been available on a competitive basis though voter approved initiatives, such as Propositions 50 and 84. The proposed 2012 Water Bond also includes potential funding for groundwater cleanup. Occasionally low or zero-interest loans are also available though State Revolving Fund programs.
- Federal Funds – Federal funding for recycling is available through the U.S. Army Corps of Engineers, via periodic Water Resource Development Act legislation, and the U.S. Bureau of Reclamation's Title XVI program.

To fund its future water quality programs, including groundwater cleanup, LADWP will seek reimbursement from potential responsible parties to assist with cleanup program costs. However, it is anticipated that water rates will need to be increased to pay for these much needed capital projects in order to ensure our groundwater supply is maximized.

## ES-8 Conclusion

---

LADWP's 2010 Urban Water Management Plan is not only designed to meet the current requirements of the UWMP Act, but also serves as the City's master plan for water supply and resource management. The UWMP provides the basic policy principles that guide LADWP's decision-making process to secure a sustainable water supply for Los Angeles in the next 25 years.

The 2010 UWMP projects a 15 percent lower water demand trend than what was projected in the 2005 UWMP. It lays out a detailed plan to develop a sustainable water supply portfolio that includes the increase of local water supplies and water conservation from the current 12 percent to 43 percent by 2035. This increased local supply mix will allow the City to reduce its reliance on the purchased MWD water supply by one-half. The focus on local supplies increases flexibility and overall water supply reliability.





## Chapter One Introduction



### 1.0 Overview

In 1902, the City of Los Angeles (City) had a population of approximately 146,000 residents and created a municipal water system by acquiring title to a private water company. In 1925, the Los Angeles Department of Water and Power (LADWP) was established by a new city charter. The availability of water has significantly contributed to the economic development of the City. LADWP met the City's need for water resources as Los Angeles developed into the nation's second largest city with over 4 million residents, encompassing a 473-square-mile area. As the largest municipal utility in the nation, LADWP delivers safe and reliable water and electricity services at an affordable price to the residents and businesses of Los Angeles.

With increasing demands for additional water supplies, LADWP and other water agencies in Southern California are faced with the challenge of providing a reliable water supply for a growing population.

LADWP plans to meet the City's water needs through the following actions:

- Significantly enhance water conservation, stormwater capture, and recycling projects to increase supply reliability.
- Implement treatment for San Fernando Basin groundwater supplies.
- Ensure continued reliability of the water supplies from the Metropolitan Water District of Southern California (MWD) through active representation of City interests on the MWD Board.
- Maintain the operational integrity of the Los Angeles Aqueduct and in-City water distribution systems.
- Meet or exceed all Federal and State standards for drinking water quality.

## 1.1 Purpose

---

The LADWP's 2010 Urban Water Management Plan (UWMP) serves two purposes: (1) compliance with the requirements of California's Urban Water Management Planning Act (Act), and (2) as a master plan for water supply and resources management consistent with the City's goals and policy objectives.

### 1.1.1 UWMP Requirements and Checklist

---

This 2010 UWMP complies with Sections 10610 and 10656 of the California Water Code, the Urban Water Management Planning Act (Act), and details how LADWP plans to meet all of the City's customer water needs. The Act became effective on January 1, 1984 and requires that every urban water supplier that provides municipal and industrial water to more than 3,000 customers (or supplies more than 3,000 acre-feet per year) prepare and adopt a UWMP every five years in accordance with prescribed requirements.

The Act was originally developed due to concerns about potential water supply shortages throughout California. Therefore, it required information that focused primarily on water supply reliability and water use efficiency measures. Since its original passage in 1983, there have been several amendments, the most recent adopted in 2009. Some of the recent amendments include: requirements to assess present and proposed future demands to achieve per capita water use reductions of 20 percent by 2020, project water use for low-income single family and multi-family residential housing, and add "indirect potable reuse" to the list of recycled water uses. A copy of the Act is provided in Appendix A. A checklist cross-referencing Act requirements to applicable pages in this UWMP is provided in Appendix B.

With the passage of Senate Bills (SB) 610 and 221 in 2001, UWMPs took on even more importance. SB 610 and 221 require counties and cities to consider the availability of adequate water supplies for certain new large developments and to have written verification of sufficient water supply to serve them. UWMPs are identified as key source documents for this verification. Based on these statutes the LADWP prepares individual Water Supply Assessments for these new large developments.

LADWP's 2010 UWMP not only meets the current requirements of the Act, but also serves as the City's master plan for water supply and resource management. The UWMP helps guide policy makers in the City and the Metropolitan Water District of Southern California (MWD) and provides information to the citizens of Los Angeles. The UWMP presents the basic policy principles that guide LADWP's decision-making process to secure a sustainable water supply for Los Angeles.

### 1.1.2 Water Supply Action Plan

---

LADWP has a long history of working to ensure that its customers have enough water. These efforts go back to the early 20th century with the building of the Los Angeles Aqueduct. Investments in water rights, aqueducts, reservoirs, conservation, and, more recently, recycled water and stormwater capture have allowed City residents to enjoy a reliable water supply. Sound planning and timely investments in water have played a critical role in meeting the water needs of the City despite the fact that Southern California is a semi-arid region.

In May of 2008, LADWP's Water Supply Action Plan (Plan), "Securing L.A.'s Water Supply", was released. It addressed a number of critical water supply reliability issues including: (1) the 2007 occurrence of the lowest snowpack on record in the

Eastern Sierras, which has historically provided Los Angeles with the greatest share of its water supply; (2) the 2007 occurrence of the driest year on record for the Los Angeles basin; (3) anticipated regional water allocations by MWD in response to dry year and regulatory reductions in imported water available from the San Francisco Bay Delta; (4) local groundwater contamination in the San Fernando Basin, restricting LADWP’s ability to fully utilize this local resource; (5) Los Angeles Aqueduct delivery reductions due to environmental mitigation and enhancements in the Owens Valley and Mono Lake Basins, totaling nearly one-half of historic water supplies from the Eastern Sierra watershed; and (6) uncertain climate change impacts which threaten traditional water supply sources.

The convergence of these critical issues has far-reaching implications for the City of Los Angeles’ water supply that require long-range planning to ensure a reliable supply of water to meet current and future demand. The Plan was a blueprint for creating sustainable water resources to serve the future needs of the City, and outlined responsible water management and long-term planning. By 2028, the Plan



envisioned a six-fold increase in recycled water supplies to a total of 50,000 Acre-Feet per Year (AFY). Similarly, by 2030 an increase of 50,000 AFY was planned for conservation. As described in the Plan, this aggressive approach included investments in state-of-the-art technology; a combination of rebates and incentives; efficient clothes washers and urinals; and long-term measures such as expansion of water recycling and treatment of contaminated groundwater supplies. A multi-faceted approach to developing a locally sustainable water supply was developed incorporating the following key short-term and long-term strategies:

#### Short-Term Conservation Strategies

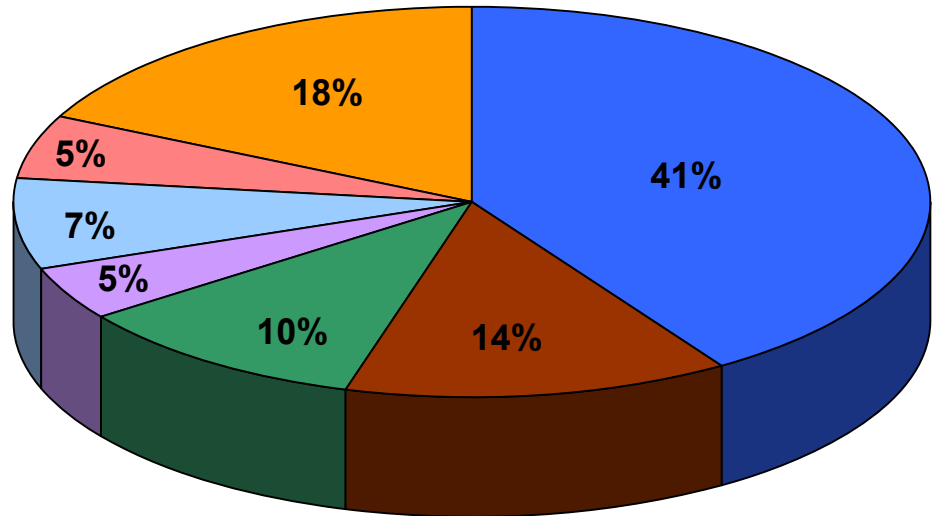
- Enforcing prohibited uses of water
- Expanding prohibited uses of water
- Extending outreach efforts
- Encouraging regional conservation measures

#### Long-Term Strategies

- Increasing water conservation through reduction of outdoor water use and new technology
- Maximizing water recycling
- Enhancing stormwater capture
- Accelerating groundwater basin treatment
- Expanding groundwater storage
- Green Building Initiatives (added subsequent to the release of the Plan)

The Water Supply Action Plan is an integral part of the UWMP, and is incorporated into the associated chapters. The UWMP outlines how the strategies contained in the Water Supply Action Plan will be implemented and how these strategies will increase the reliability of LADWP’s water supplies through 2035.

**Exhibit 1A**  
**City of Los Angeles Land Uses**



Land Use Type	Acres
Single-family Residential <sup>1</sup>	123,365
Open Space/Parks	41,317
Multi-family Residential	31,718
Commercial	13,632
Manufacturing	22,567
Public Facilities	16,314
Other <sup>2</sup>	53,731
<b>Total</b>	<b>302,644</b>

- Single-family Residential
- Multi-family Residential
- Manufacturing
- Other
- Open Space/Parks
- Commercial
- Public Facilities

Source: Data aggregated from City of Los Angeles, Department of City Planning, November, 2009

Notes:

1. Includes agricultural use as defined by LA City Planning Department
2. Includes parking, hillside area, and other miscellaneous area

## 1.2 Service Area

In order to properly plan for water supply, it is important to understand the factors that influence water demands over time. These factors include land use, demographics, and climate.

### 1.2.1 Land Use

The City of Los Angeles is comprised of approximately 302,644 acres. Residential development constitutes over 51 percent of the total land use within the City. Within the residential land use category,

single-family residential is the largest at approximately 123,000 acres or 41 percent of the total land use within the City. Multi-family residential is at approximately 32,000 acres or 10 percent of the total land use within the City. Open space/parks is the second largest land use within the City at approximately 14 percent. Commercial, public facilities and manufacturing land uses combined account for approximately 17 percent of the total. Public facilities include land uses such as libraries, public schools, and other government facilities. Exhibit 1A provides a breakdown of the land uses within the City of Los Angeles. The “Other” category includes specific plans, transportation, freeways, rights of way, hillsides, and other miscellaneous uses that are not zoned.

## 1.2.2 Demographics

Over 4 million people reside in the LADWP service area, which is slightly larger than the legal boundary of the City of Los Angeles. In addition to the City, LADWP also provides water service to portions of West Hollywood, Culver City, Universal City, and small parts of the County of Los Angeles.

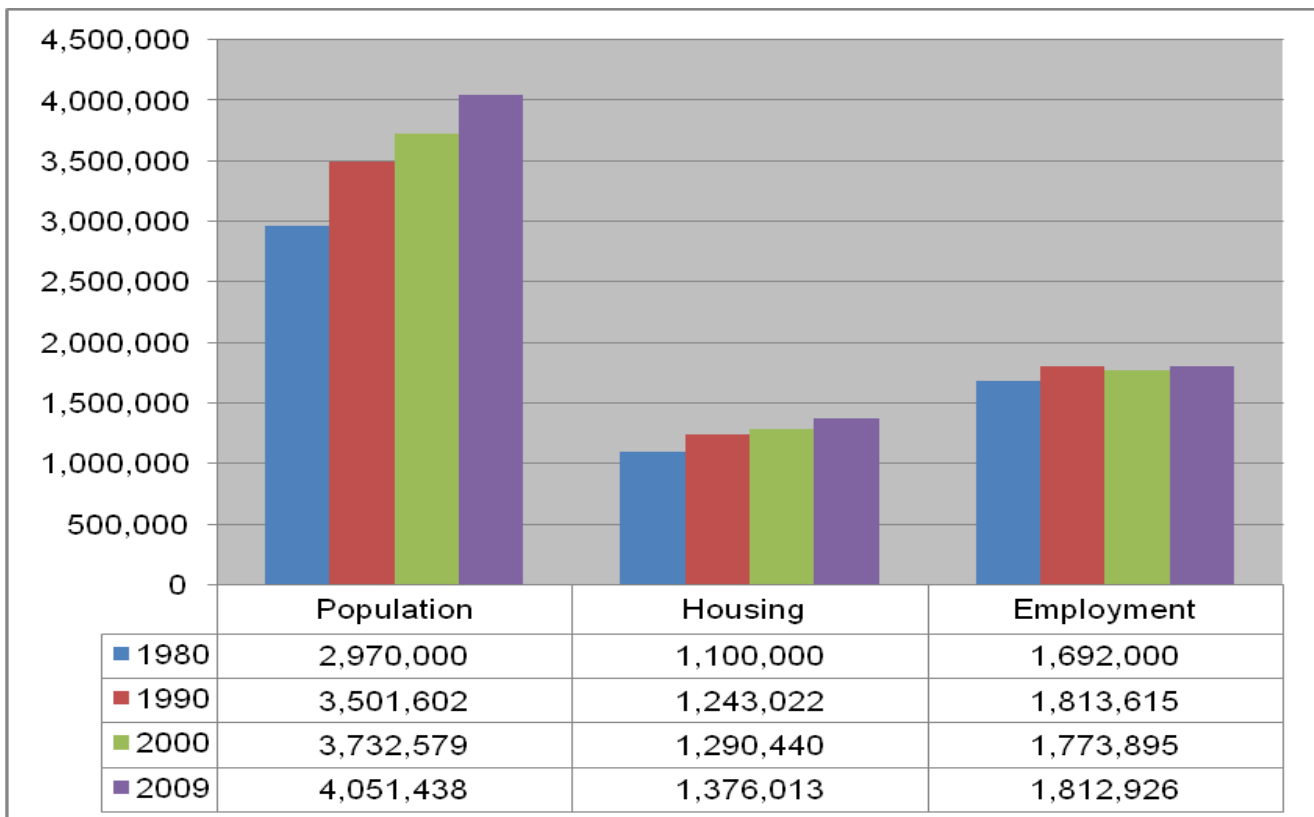
The population within LADWP's service area increased from 2.97 million in 1980 to 4.1 million in 2009, representing an average annual growth rate of 1.3 percent. The total number of housing units increased from 1.10 million in 1980 to 1.38 million in 2009, representing an average annual growth rate of 0.9 percent. During this time, average household size increased from 2.7 persons in 1980 to 2.9 persons in 2009. Employment grew by about 1.0 percent annually from 1980 to 1990, but declined from 1990 to 2000 as a result of an economic recession that started in 1991. Another decline began in 2008 reflecting the recent economic recession. Overall, employment increased by about 0.3 percent annually from 1990

to 2009. Exhibit 1B summarizes the historical demographics for the LADWP service area.

Demographic projections were obtained for the LADWP service area from the MWD. The MWD utilizes a land-use based planning tool that allocates projected demographic data from the Southern California Association of Governments (SCAG) into water service areas for each of MWD's member agencies. MWD's demographic projections use data reported in SCAG's 2008 Regional Transportation Plan (RTP). Exhibit 1C summarizes these demographic projections for the LADWP service area.

LADWP's service area population is expected to continue to grow over the next 25 years at a rate of 0.4 percent annually. While this is substantially less than the historical 1.3 percent annual growth rate from 1980 to 2009, it will still lead to approximately 367,300 new residents over the next 25 years. According to SCAG's 2008 RTP, housing is expected to grow faster than population over the next 25 years at 0.7 percent annual growth versus 0.4 percent annual growth for population,

**Exhibit 1B  
Historical  
Demographics  
for LADWP  
Service Area**



**Exhibit 1C**  
**Demographic Projections for LADWP**  
**Service Area**

Demographic	2010	2015	2020	2025	2030	2035
<b>Population</b>	4,100,260	4,172,760	4,250,861	4,326,012	4,398,408	4,467,560
<b>Housing</b>						
Single-Family	627,395	646,067	665,261	678,956	691,703	701,101
Multi-Family	764,402	804,013	846,257	880,580	914,125	942,846
Total Housing	1,391,797	1,450,080	1,511,518	1,559,536	1,605,828	1,643,947
Persons per Household	2.88	2.81	2.75	2.71	2.67	2.65
<b>Employment</b>						
Commercial	1,674,032	1,724,106	1,754,998	1,790,798	1,828,765	1,865,156
Industrial	163,382	157,652	155,012	152,426	150,009	147,508
Total Employment	1,837,415	1,881,758	1,910,010	1,943,224	1,978,773	2,012,664

Source: SCAG Regional Transportation Plan [2008], modified using MWD's land use planning to represent LADWP's service area.

and it is anticipated that household size will continue to decline over the projection period.

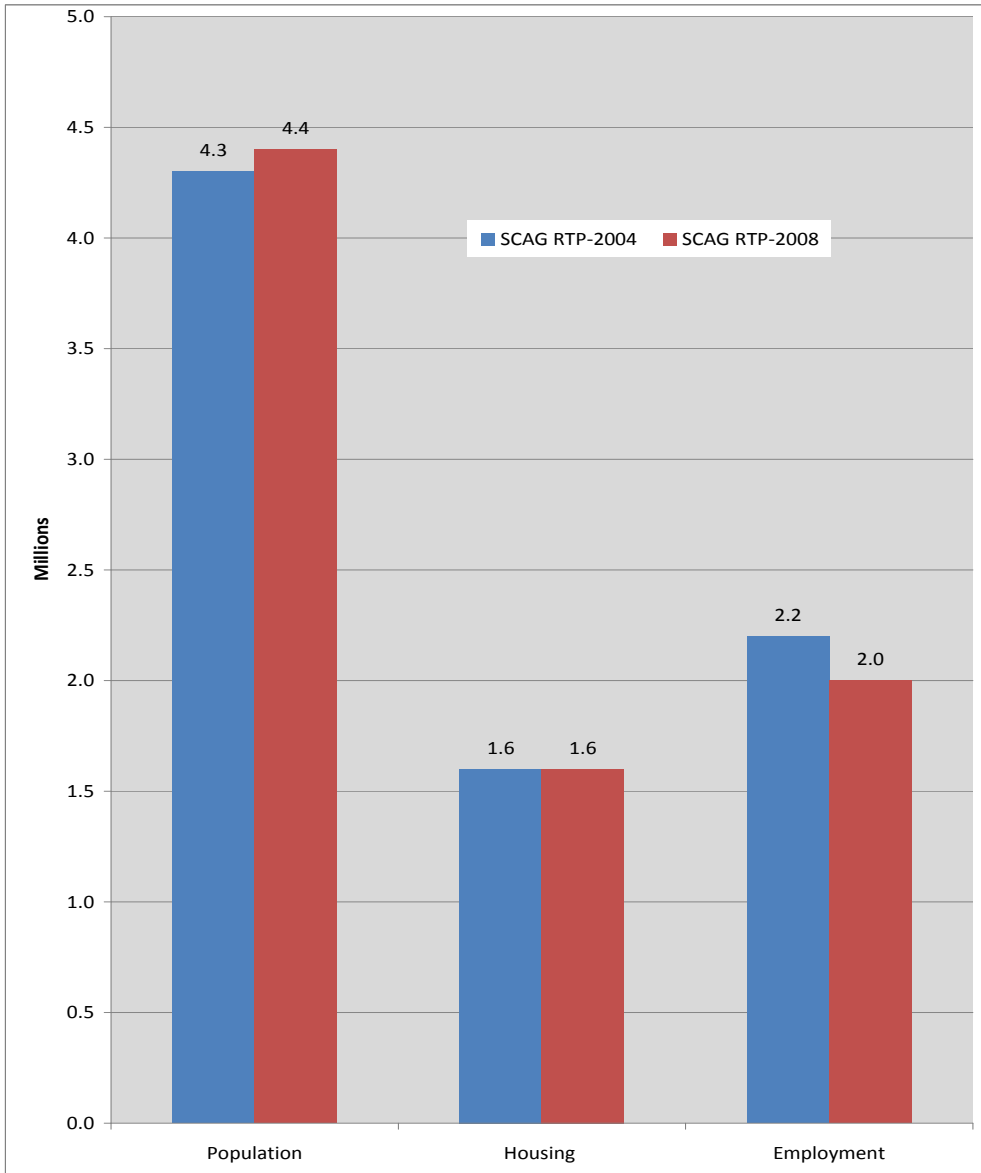
The 2008 RTP projects that by 2035 the average household size will decrease to 2.65 persons per household. Throughout the projection period, multi-family housing units are expected to increase at slightly less than twice the rate of single-family housing units (0.93 percent annual growth vs. 0.47 percent annual growth).

Employment is expected to increase by 0.4 percent annually throughout the projection period. This growth is primarily driven by the current and long-term opportunities available from the economic base within the five-county metropolitan region of Southern California. The economic base is wide-ranging and includes services, wholesale and retail trade, manufacturing, government, financial service industries, transportation, utilities, construction, education, and tourism. Over the 25-

year forecast period, industrial growth is expected to decline and experience a subtle annual negative growth of -0.4 percent, while commercial employment is expected to increase by about 0.5 percent annually.

The SCAG demographic projections for population, households, and employment included in their 2008 RTP and presented in LADWP's 2010 UWMP vary from what was presented in LADWP's 2005 UWMP. The demographic projections in the 2005 UWMP were based on SCAG's 2004 RTP. The current 2008 projections incorporate the latest population, households, and employment data from multiple local, state, and federal agencies. Projected 2008 RTP data reflect adjustments in future population growth related to declining fertility, mortality, labor force participation, and household headship rates; leveling in net migration; fluctuating net domestic migration in response to economic cycles; and an employment shift from the manufacturing

**Exhibit 1D  
Comparison  
of SCAG  
Demographic  
Projections for  
LADWP Service  
Area  
Between 2004  
and 2008 RTP  
Forecasts for  
Year 2030**



sector to the service sector. The SCAG 2008 RTP was adopted in May 2008 prior to the recent recession beginning in 2008. Additionally, MWD has further adjusted the service area boundaries based on LADWP input. Exhibit 1D shows the differences between the SCAG demographic projections for the RTP in 2004 and 2008.

For the forecast year 2030, population was projected to be 4.30 million under the SCAG 2004 RTP and 4.40 million under the 2008 RTP, a difference of 100,000. Housing was projected to be 1.60 million in 2030 under SCAG 2004 RTP and slightly more under the SCAG 2008 RTP at 1.61 million.

Employment was forecast to be less in 2030 under the newest RTP. It is projected to be 2.20 million under the SCAG 2004 RTP versus 1.98 million with the 2008 RTP. It is important to recognize that projected total employment under both the 2004 RTP and 2008 RTP continue to increase from 2010 to 2035. The 2008 RTP simply projects a lower rate of increase compared to the 2004 RTP. Conversely, the rate at which the population increases is expected to be higher with the 2008 RTP as compared with the 2004 RTP.

### 1.2.3 Climate

Weather in Los Angeles is considered mild, which is a major attribute that attracts businesses, residents, and tourists to the City. Because of its relative dryness, Los Angeles' climate has been characterized as Mediterranean. Exhibit 1E provides a summary of average monthly rainfall, maximum temperatures, and evapotranspiration readings.

The City's average monthly maximum temperature is 75 degrees Fahrenheit based on the period of 1990-2010. This is based on data from the Los Angeles Downtown weather station. The standard annual average evapotranspiration rate (ETo) for the Los Angeles area is 50.26 inches per year. ETo measures the loss of water to the atmosphere by evaporation from soil and plant surfaces and transpiration from plants. ETo serves as an indicator of how much water plants need for healthy growth. Total precipitation averages 15.58 inches per year, with over 90 percent of this total amount typically falling during the period of November through April.

### 1.2.4 Water Demand and Supply Overview

LADWP maintains historical water use data separated into the following categories: single-family residential, multi-family residential, commercial, industrial, government, and non-revenue water. Single-family residential water use is the largest category of demand in LADWP's service area, representing about 36 percent of the total. Multifamily residential water use is the next largest category of demand, representing about 29 percent of the total. Industrial use is the smallest category, representing only 4 percent of the total demand. Non-revenue water is the difference between total water delivered to the city and total water sales and has averaged 7 percent in recent years. Chapter 2 – Water Demands provides an in-depth look at water demand trends and projections for the next 25 years.

Primary sources of water for the LADWP service area are the Los Angeles Aqueducts (LAA), local groundwater, and imported supplemental water purchased from MWD. An additional fourth source, recycled water, is becoming a larger part of the overall supply portfolio. Water from two of the supply sources, the LAA and MWD, is classified as imported because it

#### Exhibit 1E Average Climate Data for Los Angeles

Average Climate Data for Los Angeles 1990-2010

	Jan	Feb	Mar	Apr	May	Jun	Jul	Aug	Sep	Oct	Nov	Dec	Annual
Average Maximum Temperature (°F) <sup>1</sup>	68	68	70	73	75	78	83	85	83	79	73	68	75
Average Precipitation (inches) <sup>1</sup>	3.62	4.46	2.28	0.75	0.34	0.12	0.01	0	0.07	0.68	0.72	2.53	15.58
Average Eto (inches) <sup>2,3</sup>	1.98	2.26	3.66	4.96	5.46	6.08	6.46	6.31	4.87	3.63	2.56	2.03	50.26

1. 1990-2010, Los Angeles Downtown USC Weather Station ID 5115

2. Average of Hollywood Hills (Station Id. 73), Glendale (Station Id. 133), and Long Beach (Station Id. 174)

3. [www.cimis.water.ca.gov](http://www.cimis.water.ca.gov)



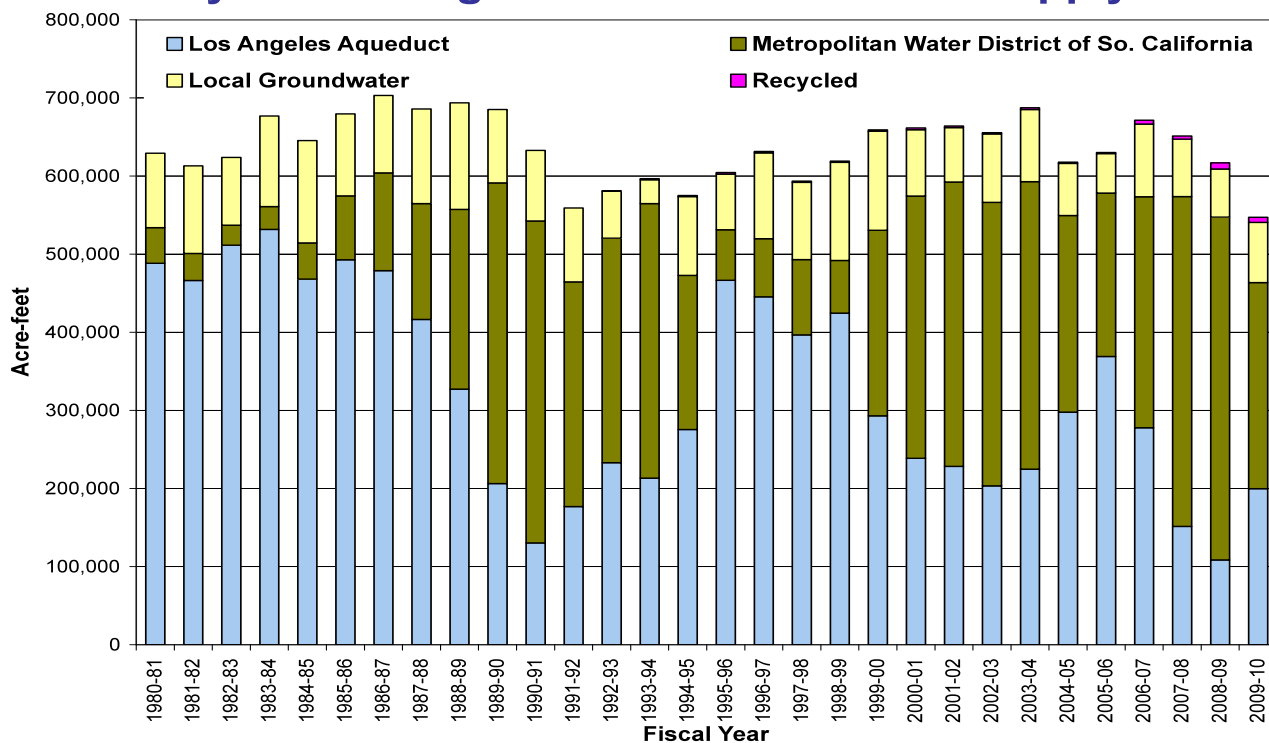
is obtained from outside LADWP's service area. Groundwater is local and is obtained within the service area. Historical supply sources are increasingly under multiple constraints including potential impacts of climate change, groundwater contamination, and reallocation of water for environmental concerns. To mitigate these impacts on supply sources, LADWP is modifying its water supply portfolio through conservation, water recycling, and stormwater capture.

The primary water supply sources are vital to maintaining LADWP's water system reliability. Pressure on one resource, such as little snowfall in the eastern Sierra Nevada Mountains, will result in an increased reliance on another resource, such as MWD. Supplies available from each source are determined using computer models in an attempt to balance total projected

supplies with projected demands. Exhibit 1F illustrates historical water supplies from 1980 to 2010. As a result of supply shortages, overall demands decreased by over 124,000 AFY in Fiscal Year (FY) 2009/10 as compared to FY 2006/07. In FY 2009/10, approximately 36 percent of the water supply was from the LAA, 14 percent from local groundwater, 48 percent from MWD, and 1 percent from recycled water. The five-year water supply averages (FY 2005/06 to FY 2009/10) were as follows: 36 percent from the LAA, 11 percent from local groundwater, 52 percent from MWD, and less than 1 percent from recycled water. The imported water (LAA water plus MWD water) supplied on average approximately 88 percent of the City's demands.

**Exhibit 1F**  
**LADWP Historical Water Supply Sources 1980-2010**

### City of Los Angeles Sources of Water Supply





# Chapter Two Water Demand

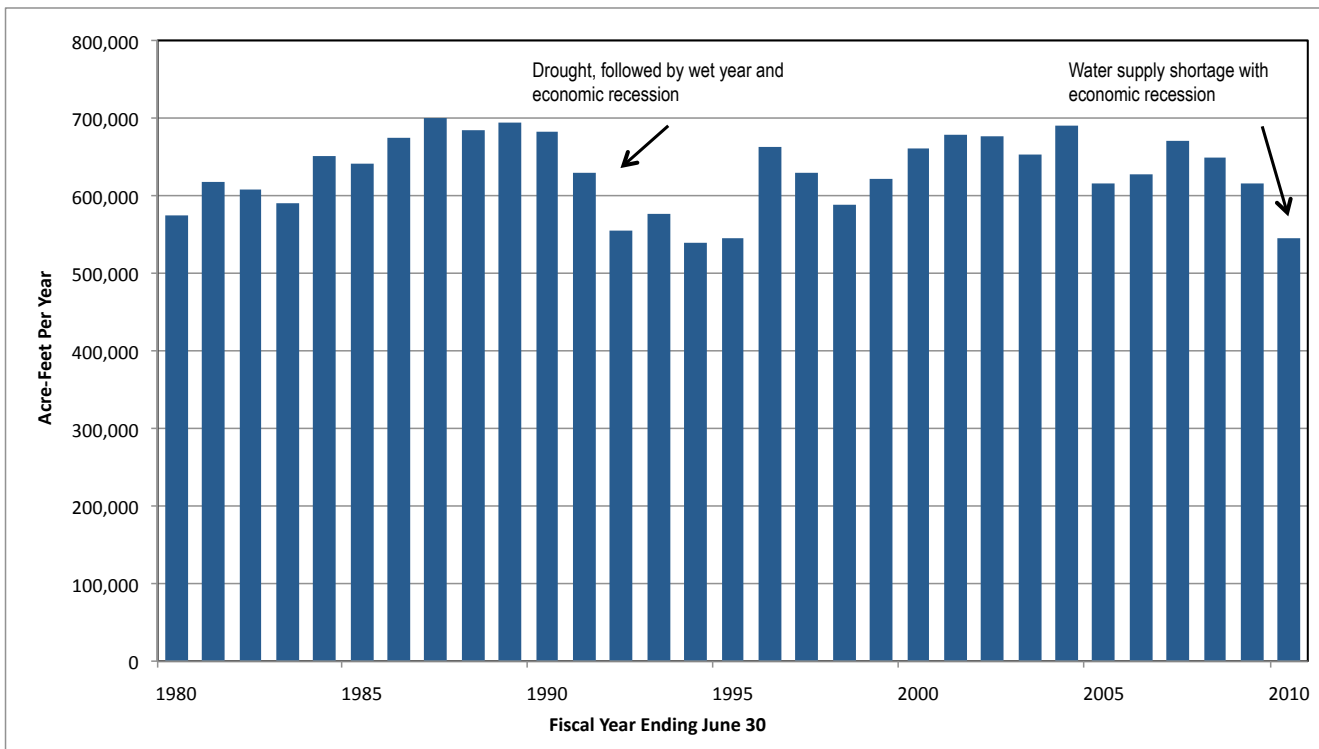
## 2.0 Overview

In order to properly plan for water supply, it is important to understand water demands and the factors that influence demands over time. LADWP maintains historical water use data separated into the following categories: single-family residential, multifamily residential, commercial, industrial, government, and non-revenue water. This categorization of demands allows better evaluation of trends in water use over time and more precise targeting of water conservation measures.

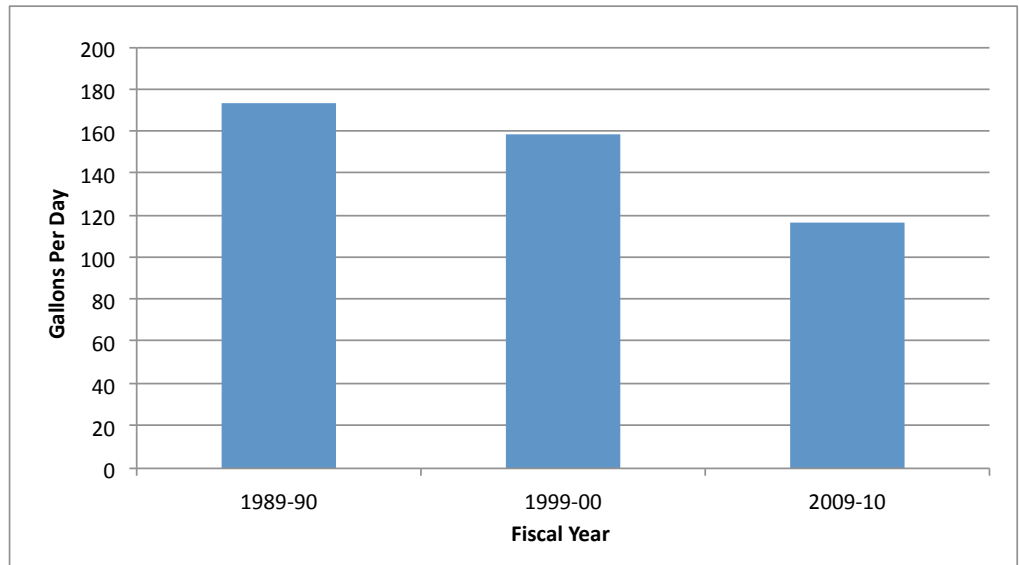
## 2.1 Historical Water Use

Exhibit 2A presents the historical water demand for LADWP. As seen in this exhibit, total water demand varies from year to year and is influenced by a number of factors such as population growth, weather, water conservation, drought, and economic activity. In 2009, a 3-year water supply shortage coinciding with an economic recession required LADWP to impose mandatory conservation. In 2010 mandatory conservation continued and the economic recession became more severe. This resulted in Fiscal Year (FY) 2009/10 water use decreasing by 19 percent from FY 2006/07 levels.

**Exhibit 2A**  
**Historical Total Water Demand in LADWP's Service Area**



## Exhibit 2B Historical Per Capita Water Use in LADWP's Service Area



Prior to 1990, population growth in Los Angeles was a good indicator of total demands. From 1980 to 1990, population in the City grew at 1.7 percent annually. Water demands during this same ten year period also grew at 1.7 percent annually. However, after 1991, LADWP began implementing water conservation measures which prevented water demands from returning to pre-1990 levels. Average water demands in the last five years from FY 2005/06 to FY 2009/10 are about the same as they were in FY 1980/81 despite the fact that over 1.1 million additional people now live in Los Angeles. This is evidenced by examining per person (or per capita) water use since 1980 (see Exhibit 2B). In FY 1989/90, per capita water use was 173 gallons per day

(gpd). By FY 1999/00, per capita water use fell to 159 gpd (or a 10 percent reduction from 1990). In FY 2009/10, per capita water use was estimated to be 117 gpd, but it is important to note that mandatory conservation and a severe economic recession were occurring at this time.

### Water Use by Sector

Exhibit 2C shows the breakdown in average total water use between LADWP's major billing categories and non-revenue water in five-year intervals for the past 25 years. Non-revenue water consists of unaccounted water and accounted non-revenue water. Accounted non-revenue water usually refers to mainline flushing at dead-end water mains to improve water quality and is less than 0.005 percent of the total demand. Unaccounted water is the system loss which includes water for fire fighting, reservoir evaporation, leakage from pipelines, meter error, and theft. Single-family residential water use comprises the largest category of demand in LADWP's service area, representing about 36 percent of the total. Multifamily residential water use is the next largest category of demand, representing about 29 percent of the total. Industrial use is the smallest category, representing only 4 percent of the total demand. Although total water use has varied substantially



from year to year, the breakdown in percentage of total demand between the major billing categories has not.

Non-revenue water has significantly decreased in recent years. Historically, non-revenue water has averaged 7 percent of total water demand. Since 2005, non-revenue water levels have averaged 5 percent. This may be attributed to a number of steps that LADWP has taken to improve its water system. In 2001, LADWP began replacing its large and intermediate meters, focusing on improving accuracy of the meters as well as their strategic placement. In addition, work to replace smaller customer meters was finally completed in FY 2009/10 which also contributed to water loss control. In FY 2007/08, an accelerated mainline replacement program was launched to repair and replace deteriorating pipelines. Furthermore, LADWP's ongoing program to remove or cover large open-air reservoirs reduces water loss due to evaporation and infiltration

### Indoor and Outdoor Water Use

In order to assess the potential for water use efficiency and target conservation programs, it is important to characterize water use in terms of indoor and outdoor demands. As with most water utilities, LADWP does not have separate irrigation meters for most of its customers. Only a small fraction of LADWP's customers, mostly parks and golf courses, have

designated irrigation meters. Therefore, measuring indoor vs. outdoor water demands involves the use of other data and assumptions.

There are two methods that LADWP uses to estimate total outdoor water use: (1) estimation of supplemental water needed for landscape irrigation in accordance with the California Model Water Efficient Landscape Ordinance; and (2) comparison of wastewater flows to total water consumption. The first method uses the following formula to estimate the water needed to supplement outdoor landscape irrigation beyond the effect of natural precipitation:

$$LW = (Eto - Eppt) \times 0.62 \times A \times ETAF$$

Where:

- LW = Estimated total supplemental water needed for landscape irrigation;
- Eto = Reference evapotranspiration for the City of Los Angeles;
- Eppt = Effective precipitation (25% of monthly precipitation);
- 0.62 = Conversion factor to gallons;
- A = Total greenscape area; and
- ETAF = Evapotranspiration (Et) adjustment factor

In 2007, an infrared analysis of the City was conducted as part of the City's Million Trees Program to determine tree canopy and landscape coverage. The infrared analysis methodology used two types of remotely sensed data, infrared imagery and aerial imagery to determine

### Exhibit 2C Breakdown in Historical Water Demand for LADWP's Service Area

Fiscal Year Ending	Single-Family		Multifamily		Commercial		Industrial		Government		Non-Revenue		Total AF
	AF	%	AF	%	AF	%	AF	%	AF	%	AF	%	
1986-90 Avg	238,248	35%	197,312	29%	123,324	18%	30,502	4%	43,378	6%	52,830	8%	685,594
1991-95 Avg	197,322	35%	177,104	31%	110,724	19%	21,313	4%	38,600	7%	24,100	4%	569,164
1996-00 Avg	222,748	35%	191,819	30%	111,051	18%	23,560	4%	39,830	6%	43,617	7%	632,626
2001-05 Avg	239,754	36%	190,646	29%	109,685	17%	21,931	3%	41,888	6%	58,299	9%	662,203
2005-10 Avg	236,154	38%	180,279	29%	106,955	17%	23,201	4%	42,940	7%	31,929	5%	621,458
25-yr Avg	226,845	36%	187,432	29%	112,348	18%	24,101	4%	41,327	6%	42,155	7%	634,209

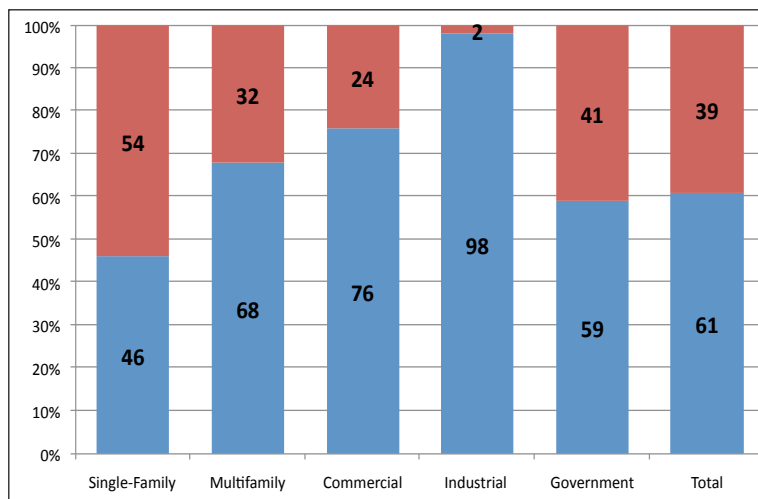
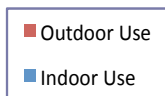
the total greenscape areas within the City. Results of this effort indicated that there is approximately 83,699 acres of greenscape in Los Angeles. The ETAF (or Et adjustment factor) of 0.8 for the City was derived from the types of plants to be irrigated and an assumed irrigation efficiency. It is consistent with the ETAF for non-rehabilitated landscapes as defined in the California Model Water Efficient Landscape Ordinance. The 2004-2007 average total water demand was selected as the basis for calculating outdoor water use percentage. This period was considered to be about average in terms of weather for Los Angeles and there were no irrigation restrictions in effect. Using the formula described previously, the supplemental water for outdoor landscaping in the City was estimated to be 249,000 AFY. During this same period, total water demand averaged 647,000 AFY. Therefore, it is estimated that the City's total outdoor water use represents approximately 39 percent of the total demand.

sanitary sewer pipes or manholes and results in overestimation of indoor water use. To minimize overestimation, only data from summer months were used to estimate average monthly wastewater attributable to indoor water use. In Los Angeles, the summer months typically have little or no measurable rainfall. Using the same pre-water restriction period of 2004-2007 selected in the first method, the average monthly wastewater flow (only the months of June through September) yields approximately 365 million gallons per day (MGD) or 403,000 AFY of estimated indoor water use. Subtracting this estimated indoor water use from the total water consumption of 647,000 AFY results in an estimated total outdoor demand of 244,000 AFY or 38 percent, which is similar to the 39 percent obtained with the landscape irrigation method. Therefore, two entirely different methods produced very similar results in estimating the total outdoor water use for the City.

Comparing wastewater flows to total water consumption is another useful method to assess overall outdoor water use. Since wastewater flow represents indoor water use that flows into the sanitary sewer system, the difference between total water consumption and wastewater flows represents outdoor water use. However, groundwater infiltration and wet weather runoff may also enter sanitary sewer systems through cracks and/or leaks in the

To obtain an estimate of indoor vs. outdoor water use for each major billing category, a minimum-month method was used. Monthly water use for single-family, multifamily, commercial, industrial, and government was obtained for 2004-2007. The water use in the minimum month, usually one of the cool/wet winter months, is assumed to be mostly indoor use. The difference between any month and the minimum month is all attributed to outdoor water use. However, based on the two prior methods, a certain amount of outdoor water use occurs even in the minimum month. Therefore, estimates of the outdoor water use that occurs in the minimum month were developed for each major billing category. Then the outdoor use of each major billing category was summed up to compare with the total outdoor water use obtained from the previous two methods. Exhibit 2D presents the estimated indoor and outdoor water use for the City using all three methods.

**Exhibit 2D  
Indoor vs.  
Outdoor  
Water Use  
in LADWP's  
Service Area**



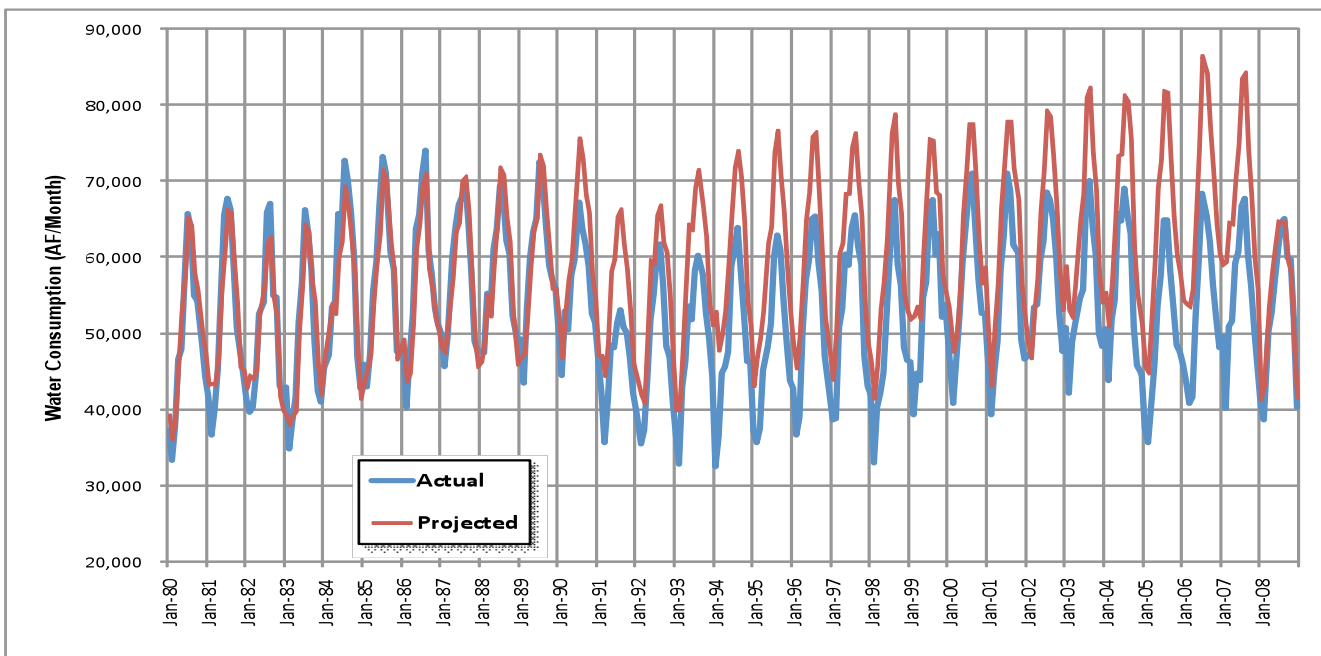
## 2.2 Quantification of Historical Water Conservation

LADWP has invested hundreds of millions of dollars in water conservation since 1990. These conservation investments include various active programs such as high efficiency toilet rebates, commercial/industrial water audits, education and public outreach, and much more. During periods of water shortage, public education and outreach are especially important and has contributed to significant reductions in water use. In an effort to quantify its water conservation efforts, LADWP developed a statistical Conservation Model that correlates total monthly water use in the City with population, weather, the presence of mandatory water conservation, and economic recessions. The model can be used to predict what the water demand would be under actual weather conditions, population growth and economy, but without active or drought water conservation in

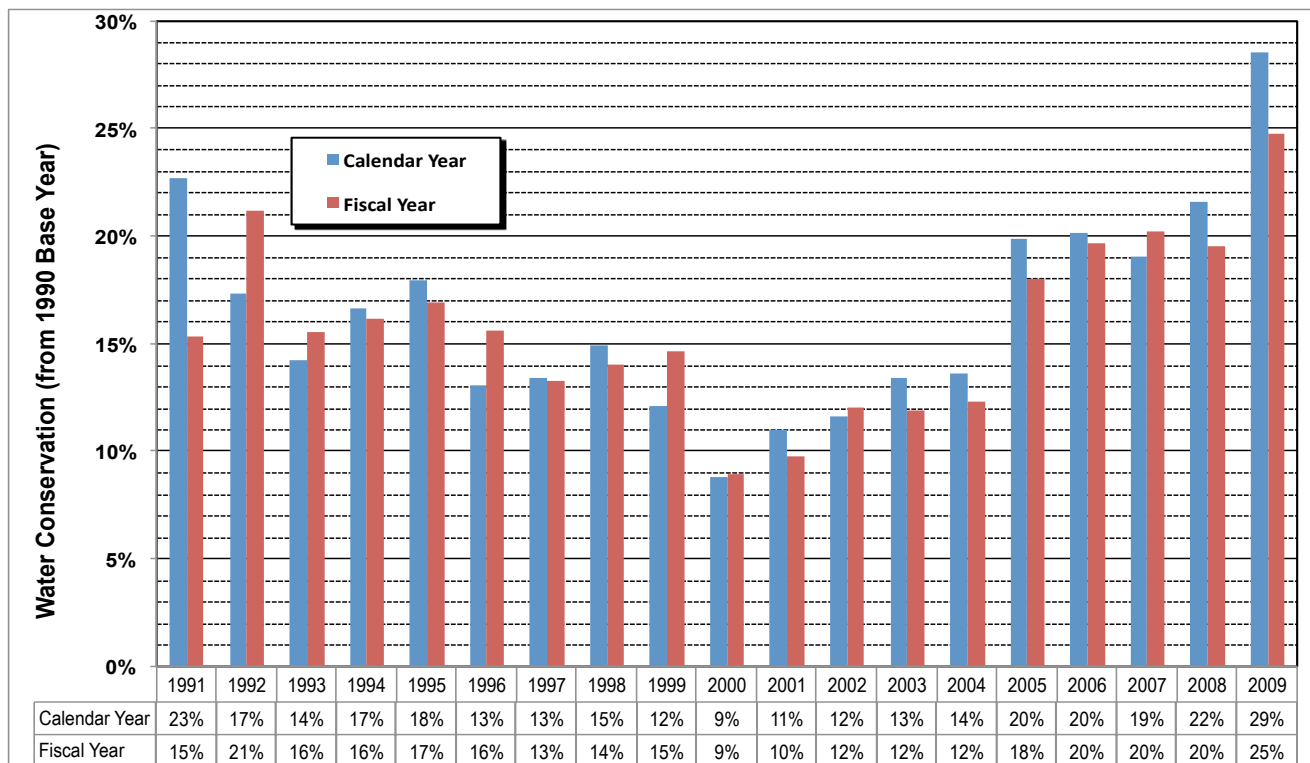
place. This modeled water consumption without conservation is then compared to actual water consumption—with the difference being attributed to water conservation. In order to assess the model’s accuracy, the model was used to “back cast” the period from 1980 to 1990 when conservation was not implemented. In this case, the modeled water consumption was very close to the actual water consumption. After 1990, it was expected that the modeled water consumption will be greater than actual water consumption as LADWP has implemented increasing levels of water conservation measures. Exhibit 2E presents modeled and actual monthly water consumption from 1980 to 2009. As seen, the Conservation Model is performing as expected. The modeled water consumption (red line) is nearly identical to the actual water consumption (blue line) up until 1990. After 1990, the modeled water consumption is greater than actual water consumption.

Exhibit 2F summarizes the annual estimated water conservation using the Conservation Model. During periods of

**Exhibit 2E**  
**Modeled vs. Actual Monthly Water Consumption for LADWP**



**Exhibit 2F**  
**Estimates of Total Water Conservation in LADWP's Service Area**



water shortage, even when mandatory water conservation is not in place, there is more conservation occurring due to extensive public education and outreach. Water conservation in 2009 represents the highest levels of conservation so far, which reflects a combination of active conservation programs, heightened public education and outreach, and mandatory conservation measures.

**2.3 Water Demand Forecast**

**Demand Forecast Methodology**

LADWP has developed a water demand forecast for each of its major categories of demand. This allows the City to better understand trends in water use and target conservation programs. The methodology used for the demand forecast is called a modified unit use approach. The following steps are used in this approach:

Step 1: Estimate baseline per unit water use – take each billed category of water demand (e.g., single-family, industrial, etc.) for a base (or starting) period and divide by associated demographic driver (e.g., number of single-family homes or number of industrial employees). This yields for instance, a baseline of 359 gallons used each day in a single-family residence.

Step 2: Modify the estimated baseline per unit water use to account for future changes in the following socioeconomic variables: price of water, personal income, family size, economy, drought conservation effect, and passive water conservation (which accounts for efficiencies in water use from state and local plumbing codes and ordinances).

Step 3: Multiply modified per unit water use for each category in Step 2 by the associated projected



## Exhibit 2G

### Projected Demographic Drivers

(Based on MWD allocated 2008 SCAG forecast data with corrected service area boundary, 5-17-2010)

Fiscal Year Ending	Single-Family (# Homes)	Multi-Family (# Homes)	Commercial/Government (# Employees)	Industrial (# Employees)	Landscaping (# of MF Homes)	Non-Revenue Water* (%)
2010	627,395	764,402	1,674,032	163,382	764,402	6.9%
2015	646,067	804,013	1,724,106	157,652	804,013	6.9%
2020	665,261	846,257	1,754,998	155,012	846,257	6.9%
2025	678,956	880,580	1,790,798	152,426	880,580	6.9%
2030	691,703	914,125	1,828,765	150,009	914,125	6.9%
2035	701,101	942,846	1,865,156	147,508	942,846	6.9%

\* Calculated from difference between historical production and billing data

demographic drivers (see Exhibit 2G) in order to obtain projected water demands by billed category that does not include active water conservation (which is defined as conservation achieved through LADWP incentives such as rebates and programs).

Step 4: Estimate non-revenue water (the difference between total water consumption and billed water use) by applying a non-revenue water use factor, and add non-revenue water to the billed category water demands in Step 3 in order to get a forecast of total water consumption without active water conservation.

Step 5: Subtract future projections of active water conservation from the total water consumption in Step 4 in order to determine the water demand forecast that is fully inclusive of both passive and active water conservation.

### Applying the Methodology

In Step 1 of this method, historical water demands for single-family, multifamily, commercial/government, and industrial were averaged from 2005 to 2008 to determine the baseline. This period was used because on average, it represented normal weather conditions, and it was before mandatory outdoor water use restrictions were in effect. For each of these categories, the water demand was divided by a demographic driver that could be projected into the future. The result of this calculation is a water demand expressed as a unit water use rate. Exhibit 2H presents this unit use calculation for the baseline.

Step 2 in the methodology involves modifying these baseline unit use rates to account for changes in the following socioeconomic variables: price of water, personal income, family size, economy, drought conservation effect, and passive water conservation. MWD has developed an Econometric Water Demand Model as part of its 2010 Integrated Water Resources Plan that is able to account for the impact that personal income, family

## Exhibit 2H

### Baseline Unit Water Use Rates (2005-2008)

Source: California Department of Finance and Employment Development Department

Demand Category	Average Water Demand (AFY)	Average Demographic Driver *	Average Unit Use Rate (gallons/day/driver)
Single-Family	244,407	607,301 (homes)	359
Multifamily	184,428	734,461 (homes)	224
Commercial/Gov	153,199	1,631,896 (employees)	84
Industrial	23,613	160,328 (employees)	132

size, and price of water have on water demands. For each of these factors, a statistical coefficient or elasticity was estimated from MWD’s Econometric Water Demand. The elasticity is generally interpreted as a percent change in water use resulting from a percent change in a specific socioeconomic variable. For example, a price elasticity of -0.131 would imply that a 10 percent increase in the real price of water would result in a 1.24 percent decrease in water demand (e.g.  $1.24\% = 1 - (1 + 10\%)^{-0.131}$ ). The following elasticities used in MWD’s Econometric Water Demand Model were also used for LADWP’s water demand forecast:

	Price of Water	Income	Family Size
Single-Family	-0.131	+0.270	+0.550
Multifamily	-0.109	+0.310	+0.450
Commercial/ Government	-0.107		
Industrial	-0.107		

Source: MWD 2010 Integrated Water Resources Plan Update Appendix A.2 Demand Projections

The price elasticities reflect a reduction of approximately 1/3 from those tabulated in MWD’s 2010 IRP. However, MWD’s 2010 IRP Appendix A.1 states that consumers respond to price increase by installing water-conserving fixtures and appliances. As more water efficient fixtures are

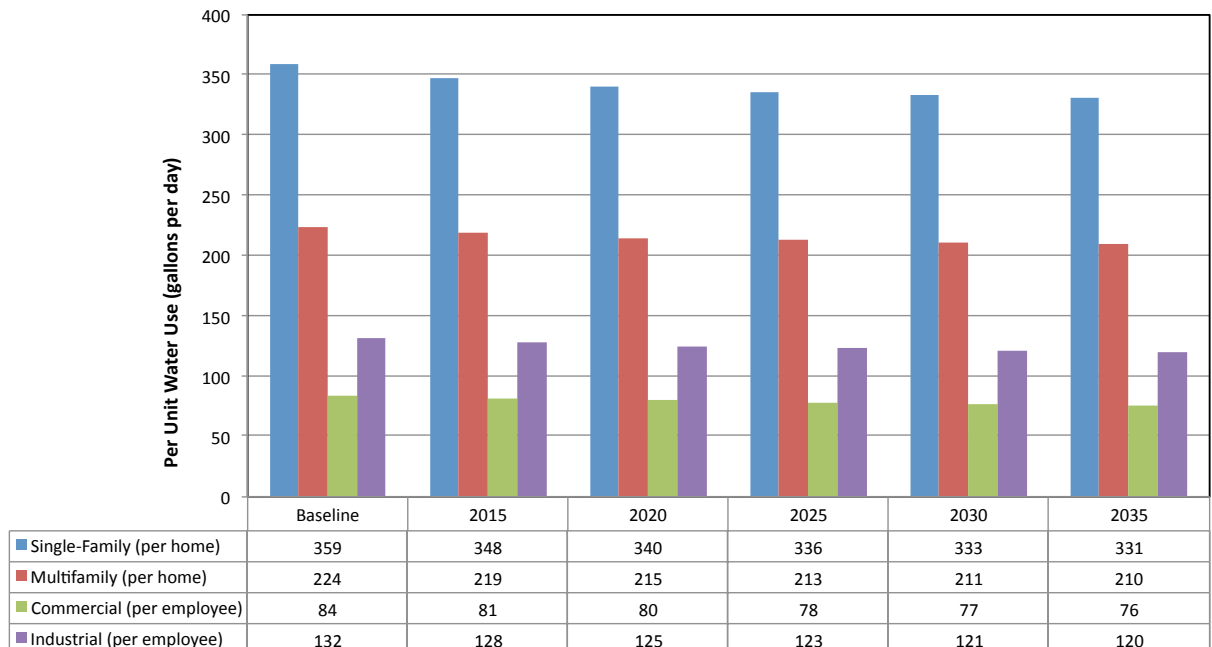
installed, the impact of changing water-using behavior through rates is reduced. This is known as “demand hardening”. Reducing price elasticity is done to avoid double-counting conservation savings and to account for demand hardening.

Exhibit 2I presents the modified per unit water use over time that incorporates future real increases in the price of water, personal income, and projected changes in family size. Also incorporated are the residual drought conservation effect from the significant public education and mandatory water use restrictions that occurred during the drought period of 2009 through 2010, and the effect of passive conservation due to mandated efficiencies from plumbing codes and ordinances.

## Water Demand Forecast Results

Steps 3, 4, and 5 involve applying the modified per unit water use factors shown in Exhibit 2J to the projected demographics for LADWP (see Chapter 1), then adding non-revenue water, and subtracting projected active water conservation (that is summarized in Chapter 3). The result of these steps is the water demand forecast for each of the major categories of demand.

### Exhibit 2I Projected Unit Water Use



**Exhibit 2J**  
**Water Demand Forecast and Conservation Savings Under Average Weather**  
**Fiscal Year Ending June 30 (Acre-Feet)**

Demand Forecast with Passive Water Conservation	2005	2010	2015	2020	2025	2030	2035
Single-Family		198,444	229,115	241,976	249,528	257,693	259,904
Multifamily		167,299	179,653	194,724	205,136	216,054	221,912
Commercial/Gov		135,000	143,081	149,597	153,791	158,628	160,049
Industrial		20,298	20,524	20,726	20,532	20,408	19,852
Non-Revenue		33,515	42,421	44,989	46,617	48,380	49,042
<b>Total</b>		<b>554,556</b>	<b>614,794</b>	<b>652,012</b>	<b>675,604</b>	<b>701,164</b>	<b>710,760</b>
Demand Forecast with Passive & Active Water Conservation	2005 Actual	2010 Actual	2015	2020	2025	2030	2035
Single-Family	233,192	196,500	225,699	236,094	241,180	246,879	247,655
Multifamily	185,536	166,810	178,782	193,220	202,999	213,284	218,762
Commercial/Gov	107,414	130,386	135,112	133,597	129,761	126,567	120,420
Industrial	62,418	19,166	18,600	16,852	14,708	12,634	10,513
Non-Revenue	26,786	32,909	41,370	42,969	43,627	44,421	44,272
<b>Total</b>	<b>615,346</b>	<b>545,771</b>	<b>599,563</b>	<b>622,732</b>	<b>632,275</b>	<b>643,785</b>	<b>641,622</b>
Aggregate Active Water Conservation Savings From Jul 07	2005	2010	2015	2020	2025	2030	2035
Single-Family		1,944	3,416	5,882	8,349	10,815	12,249
Multifamily		489	871	1,504	2,137	2,770	3,150
Commercial/Gov		4,614	7,969	16,000	24,030	32,061	39,629
Industrial		1,132	1,924	3,874	5,824	7,774	9,339
Non-Revenue		606	1,051	2,020	2,990	3,959	4,771
<b>Total</b>		<b>8,785</b>	<b>15,231</b>	<b>29,280</b>	<b>43,329</b>	<b>57,379</b>	<b>69,138</b>

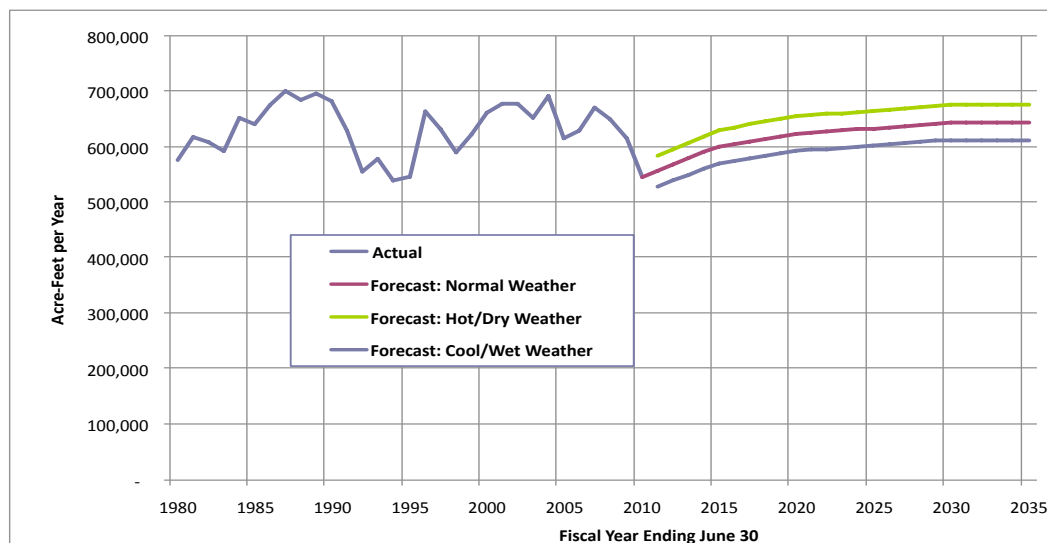
\* Non-revenue is the combination of unaccounted water and accounted non-revenue water. Unaccounted water is defined as system losses. In recent years, the City experienced no accounted non-revenue water. Thus, non-revenue water is considered system loss.

**Water Demand Forecast with Average Weather Variability**

Using the weather coefficients from the statistical water conservation model (see Exhibit 2E), annual weather adjustment factors can be derived to determine the range in forecasted water demands due to historical weather variability. This is accomplished by projecting water demands assuming long-term normal

weather, and then comparing this normal-weather demand to actual demands. After adjusting for economy and drought conditions, projected water demands can vary by approximately ± 5 percent in any given year due to average historical weather variability. This means that water demands under cool/wet weather conditions could be as much as 5 percent lower than normal demands on average; while water demands under hot/dry

**Exhibit 2K**  
**Water Demand Forecast with Average Weather Variability**



**Exhibit 2L**  
**Water Demand Forecast for Low-Income Residential Customers**  
**Fiscal Year Ending June 30**

<b>Low-Income Single-Family Customers</b>	<b>2015</b>	<b>2020</b>	<b>2025</b>	<b>2030</b>	<b>2035</b>
Number of Homes	42,640	43,907	44,811	45,652	46,273
Household Water Use (Gallons/Day)*	250	253	254	255	252
Demand Forecast (Acre-Foot/Year)	11,917	12,466	12,734	13,035	13,076
<b>Low-Income Multifamily Customers</b>	<b>2015</b>	<b>2020</b>	<b>2025</b>	<b>2030</b>	<b>2035</b>
Number of Homes	131,054	137,940	143,535	149,002	153,684
Household Water Use (Gallons/Day)*	159	163	165	167	166
Demand Forecast (Acre-Foot/Year)	23,313	25,196	26,471	27,812	28,527
<b>Total Low-Income Residential Customers</b>	<b>2015</b>	<b>2020</b>	<b>2025</b>	<b>2030</b>	<b>2035</b>
Demand Forecast (Acre-Foot/Year)	35,230	37,662	39,205	40,847	41,603

\* Assumes same percent conservation as system for single-family and multifamily homes.

weather conditions could be as much as 5 percent higher than normal demands on average. Exhibit 2K presents LADWP’s historical and forecasted total water demands with both passive and active conservation, under the full range of historical weather variability.

**Low-Income Water Demand Projections**

The requirements for the 2010 UWMP call for projections of water demands for low-income customers. For rate relief purposes, LADWP maintains records of low-income water customers. For the FY 2009/10, approximately 6.6 percent of the total number of single-family homes in the City was classified as low-income. On average, these customers used about 20 percent less water per household than overall single-family customers. To forecast low-income single-family water demand, the 6.6 percent ratio of low-income to total single-family homes was applied to determine the total number of low-income single family homes. The system wide per unit water use for single-family homes was reduced by 20 percent and multiplied by the total number of low-income single-family homes to determine low-income single-family water demand.

Because the water services of multifamily residential customers are typically not individually metered, a multifamily water

account can represent upwards of 100 homes. Therefore, a different approach was used. LADWP’s power system does individually meter multifamily homes and also classifies homes as low-income for rate relief purposes. Therefore, the ratio of current low-income to total multifamily homes in the City was applied to the total projection of multifamily homes in order to project the total number of low-income multifamily homes. For the FY 2009 /10, approximately 16.3 percent of the total number of multifamily homes in the City were classified as low-income. Assuming that low-income multifamily homes also use 20 percent less water than overall multifamily homes, an adjusted per unit water use for multifamily homes was multiplied by the projected number of low-income multifamily homes to determine low-income multifamily water demand. Exhibit 2L presents the water demand forecast for low-income residential water customers.



## Chapter Three Water Conservation



### 3.0 Overview

Multiple factors are increasingly restricting LADWP's traditional water supply sources. The City of Los Angeles has long recognized water conservation as the core of multiple strategies to improve overall water supply reliability. In May of 2008, LADWP's Water Supply Action Plan, "Securing L.A.'s Water Supply", was released in response to factors impacting LADWP's major water supply sources beginning in 2007. The Water Supply Action Plan calls for reducing potable water demands by an additional 50,000 AFY by 2030 through conservation, incorporating multiple conservation strategies to increase the sustainability of LADWP's water supply. Additional conservation efforts will increase this total to 64,368 AFY by 2035.

Los Angeles has historically taken a leadership role in managing its demand for water. Los Angeles consistently ranks among the lowest in per person

water consumption when compared to California's largest cities. This significant accomplishment has resulted from the City's sustained implementation of effective water conservation programs since the 1980s.

One of LADWP's most effective conservation tools is the sustained conservation ethic of its customers. During past droughts and water shortages, residents and businesses have aggressively implemented additional conservation to achieve demand reductions. During FY 09/10, water use was below 1979 water use levels thanks to extraordinary conservation efforts by LADWP customers. Specifically, water use in FY 09/10 was almost 20 percent lower than water use in FY 06/07 with single-family residential water use 25 percent lower, multi-family water use 11 percent lower, commercial water use 16 percent lower, industrial water use 15 percent lower, and governmental water use 33 percent lower.

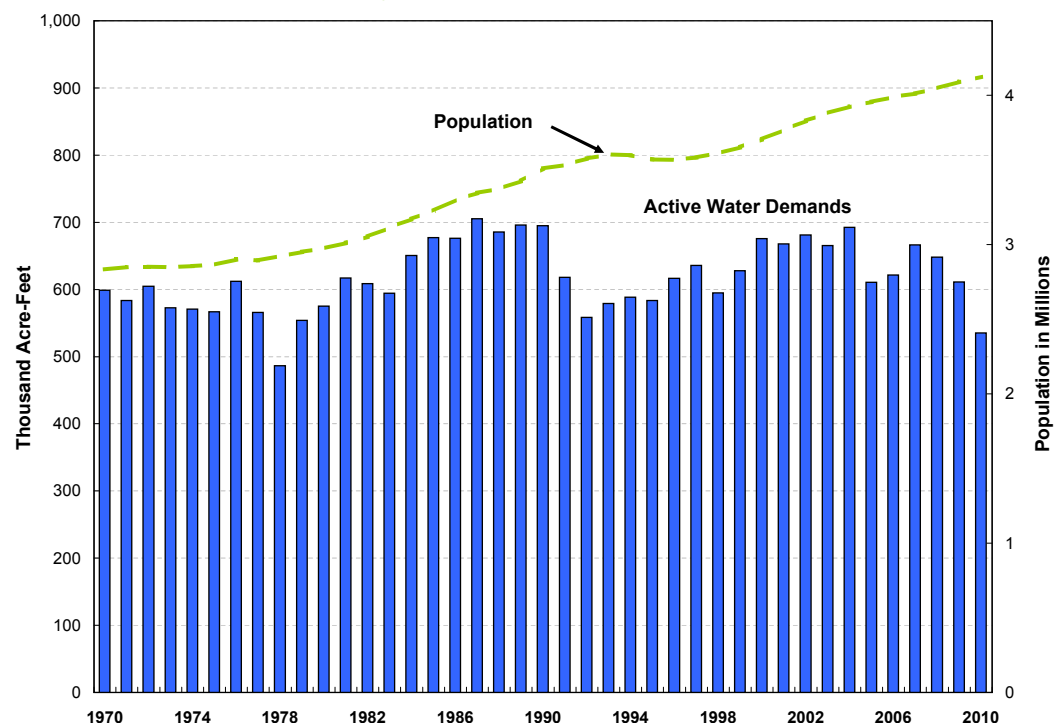
LADWP has continually invested in water conservation programs and measures targeting cost-effective reductions in water use. Looking forward, LADWP plans to continue to make investments in conservation programs and expand its focus on landscape water use efficiency and conservation opportunities in the commercial/industrial/institutional (CII) customer sectors. LADWP's conservation planning process includes working with other City departments to ensure that mutual needs are addressed and goals are achieved (e.g., landscape water use efficiency and dry weather runoff reduction).

The civic cultural ethic of water conservation in Los Angeles began with the installation of water meters on all services in the early 1900's. At that time, this foundational conservation measure resulted in a 30 percent reduction in water use. During the recurrence of periodic water shortages, LADWP customers have demonstrated concern and responsiveness to the need for additional conservation. When faced with significant supply shortages, City residents have responded with unprecedented reductions in their water use. Los Angeles was one

of the first cities in southern California to invoke mandatory water rationing during the 1976 through 1977 drought. While severe, this two-year dry period resulted in only a temporary reduction in water use, as a subsequent series of wet years erased memories of the water shortage experienced during the brief dry period. However, it was the multiple dry years that followed the 1978 through 1986 wet cycle that would prove to be the turning point in Los Angeles' water use efficiency.

The dry years of 1987-1992 left a permanent imprint on Los Angeles water customers. In response to this water shortage, LADWP expanded its voluntary water conservation program. Prompted by an extensive public awareness program and education campaign, LADWP customers responded not only with water saving practices but also by installing conservation measures in their homes and businesses. Devices such as low-flow showerheads and ultra-low-flush (ULF) toilets replaced existing high water use devices. These hardware changes, coupled with more efficient use habits, have significantly reduced the amount of imported water that the City would need to buy as its population and commerce

**Exhibit 3A**  
**Historical City of Los Angeles Water Use**



**Exhibit 3B**  
**Historical City of Los Angeles Conservation**

Fiscal Year	Additional Annual Hardware Installed Savings (AF)	Cumulative Annual Hardware Savings (AF)	Annual Non-Hardware Savings (AF) <sup>1</sup>	Annual Total Savings (AF)
Prior to 1990/1991	31,825	31,825		
1990/1991	4,091	35,916	76,350	112,267
1991/1992	8,670	44,586	105,593	150,179
1992/1993	3,286	47,872	58,546	106,417
1993/1994	4,961	52,832	60,928	113,761
1994/1995	4,041	56,873	62,084	118,958
1995/1996	4,642	61,516	52,648	114,164
1996/1997	2,376	63,892	33,720	97,612
1997/1998	2,637	66,529	30,434	96,964
1998/1999	2,781	69,310	38,305	107,614
1999/2000	3,532	72,842	-6,262	66,580
2000/2001	3,078	75,920	-3,407	72,513
2001/2002	2,452	78,371	15,131	93,502
2002/2003	2,630	81,002	8,725	89,726
2003/2004	3,257	84,259	13,107	97,366
2004/2005	3,299	87,558	46,865	134,423
2005/2006	2,404	89,963	62,223	152,186
2006/2007	2,095	92,058	76,643	168,701
2007/2008	782	92,840	64,472	157,312
2008/2009	3,127	95,967	106,151	202,118
2009/2010	4,269	100,236	126,466	226,702

1. Negative non-hardware savings are due to overestimation in hardware savings due to years with extreme wet weather conditions.

continued to grow. In response to current water shortage conditions the City reinitiated its extensive public awareness campaigns, in addition to campaigns launched by MWD, to encourage water saving practices and installation of conservation devices in homes and businesses.

As a result of mandatory conservation and reduced deliveries of imported water from MWD, residential customers have attained conservation levels exceeding 20 percent during the period between 2007 and 2010. In response to the current water supply shortage, the City has updated its Emergency Water Conservation Plan Ordinance's enforceable water waste provisions and mandatory outdoor watering restrictions. In addition, the City has implemented water shortage year rates reducing Tier 1 water allotments for customers by 15 percent. As a direct result of conservation, imported water purchases from MWD are 23 percent

below baseline allocations for FY 2009/10. In response to recently enacted State laws, LADWP has developed new water conservation goals which aim to reach approximately 64,000 AFY in hardware conservation savings by 2035.

Conservation has had a tremendous impact on Los Angeles' water use patterns and has become a permanent part of LADWP's water management philosophy. The City's water usage in 2010 was less than 1979 despite an increase in population of over 1,000,000 people (see Exhibit 3A). Exhibit 3B shows historical conservation savings from FY 1990/91 through FY 2009/10 based on installation of conservation devices subsidized through rebates and incentives. Cumulative annual hardware savings since the inception of LADWP's conservation program totals 100,236 AFY. Additional conservation was achieved through changes in customer behavior and lifestyle changes.

Conservation benefits the City by improving water supply reliability and reducing embedded energy use for water treatment and pumping. Conserving customers see a tangible benefit as well through monetary savings on their water bill. Another ancillary benefit of conserving water is that the need for costly sewer facility expansions is deferred as wastewater discharge into the sewer collection and treatment systems is reduced, thus increasing the lifespan of current sewer infrastructure. Water conservation also has the added benefits of reducing greenhouse gas emissions and energy use. Delivering water supplies to and within the LADWP service area and heating water for showers, dishwashing, etc. all require large amounts of energy. In the end, the primary beneficiaries of conservation are the water customers and the environment where the supplies originate. Furthermore, increased conservation results in decreased dry weather runoff which decreases the amount of pollutants flowing into local rivers and the Pacific Ocean.

Los Angeles has been implementing permanent conservation since the 1980's. In 1988, the City adopted a plumbing retrofit ordinance to mandate the installation of conservation devices in all properties and to require water-efficient landscaping in all new construction. The ordinance was amended in 1998, requiring the installation of ULF toilets and water saving showerheads in single-family and multi-family residences prior to resale. A new ordinance adopted in 2009, the Water Efficiency Requirements ordinance, establishes water efficiency requirements for new developments and renovations of existing buildings by requiring installation of high efficiency plumbing fixtures in all residential and commercial buildings. LADWP's past water conservation programs have assisted customers affected by the ordinances by offering free ULF toilets and showerheads, free installation of ULF toilets, showerheads and faucet aerators, as well as rebates for ULF toilets purchased and installed. Current water conservation programs co-sponsored by MWD through the SoCal

Water\$mart Program for residential customers and the Save Water Save a Buck Program for CII customers continue to assist customers in complying with ordinances and reducing overall water demands.



### 3.1 Water Conservation Goals

---

Water conservation reduces demand that typically rises over time with growth in population and commerce. By mitigating those increases in demand, water supply reliability is improved while costs are reduced. In the early 1990s, City residents responded with conservation levels exceeding 20 percent due to increasingly drier conditions and mandatory conservation. As normal water supply conditions returned and with continuation of LADWP's conservation program, conservation levels stabilized at approximately 15 percent. With the recent water shortage and reduced deliveries of imported water from MWD, residential customers have repeated conservation levels exceeding 20 percent in the period between 2007 and 2010 as a result of mandatory conservation. From July 2007 through February 2011, 90.6 billion gallons of water were saved through conservation. As a direct result of conservation, imported water purchases from MWD are 23 percent below baseline allocations for FY 2009/10. In response to the goals provided in the Plan and recently enacted State laws, LADWP has developed numerous water conservation programs.



### 3.1.1 Water Supply Action Plan Conservation Goal

---

To continue increased conservation levels once mandatory outdoor watering restrictions are lifted, LADWP has set a water conservation goal in the Water Supply Action Plan of reducing potable water demands by an additional 50,000 AFY by 2030. This conservation level will further lessen the City's reliance on imported water while providing a drought-proof resource that is not subject to weather conditions. This aggressive approach includes multiple strategies: investments in state-of-the-art technology; a combination of rebates and incentives promoting installation of weather-based irrigation controllers (WBICs), efficient clothes washers and urinals; expansion and enforcement of prohibited water uses; reductions in outdoor water use; extending education and outreach efforts; and encouraging regional conservation.

LADWP's commitment to conservation is a successful multi-faceted approach that includes tiered water pricing, education and awareness, financial incentives for the installation of a variety of conservation measures, free water saving showerheads, Technical Assistance Program (TAP) incentives for business and industry, and large landscape irrigation efficiency programs. Conservation is a foundational component of LADWP's water resource planning efforts and will continue to be over the long term.

### 3.1.2 Water Conservation Act of 2009

---

The Water Conservation Act of 2009, Senate Bill x7-7, requires water agencies to reduce per capita water use by 20 percent by 2020 (20x2020). This includes increasing recycled water use to offset

potable water use. Water suppliers are required to set a water use target for 2020 and an interim target for 2015 using one of four methods. The 2020 urban water use target may be updated in a supplier's 2015 UWMP. Failure to meet adopted targets will result in the ineligibility of a water supplier to receive water grants or loans administered by the State unless one of two exceptions is met. Exception one states a water supplier may be eligible if they have submitted a schedule, financing plan, and budget to Department of Water Resources (DWR) for approval to achieve the per capita water use reductions. Exception two states a water supplier may be eligible if an entire water service area qualifies as a disadvantaged community.

Four methodologies are stipulated for calculating the water use target. Three of the methods are listed in Water Code § 10608.20(a)(1). The fourth method was developed by DWR. The four methodologies are:

- Method 1 – Eighty percent of the water supplier's baseline per capita water use.
- Method 2 – Per capita daily water use estimated using the sum of performance standards applied to indoor residential water use, landscape area water use, and commercial, industrial, and institutional water uses.
- Method 3 – Ninety-five percent of the applicable State hydrologic region target as stated in the State's *draft 20x2020 Water Conservation Plan*.
- Method 4 – Developed through public process. This method allows flexibility in its calculation to account for the highly diverse conditions of each agency's landscape, commercial, industrial, and institutional water needs and to give credit for past conservation efforts. For more information please go to: <http://www.water.ca.gov/wateruseefficiency/sb7/committees/urban/u4/>

**Exhibit 3C  
20x2020  
Base and  
Target Data**

20x2020 Required Data	Gallons Per Capita Per Day (GPCD)
<b>Base Per Capita Daily Water Use</b>	
10-Year Average <sup>1</sup>	152
5-Year Average <sup>2</sup>	145
<b>2020 Target Using Method 3<sup>3</sup></b>	
95% of Hydrologic Region Target (149 gpcd)	142
95% Of Base Daily Capita Water Use 5-Year Average (145 gpcd)	138
<b>Actual 2020 Target</b>	138
<b>2015 Interim Target</b>	145

1. Ten-year average based on fiscal year 1995/96 to 2004/05

2. Five-year average based on fiscal year 2003/04 to 2007/08

3. Methodology requires smaller of two results to be actual water use target to satisfy minimum water use target.

In 2015, urban retail water suppliers will be required to report interim compliance followed by actual compliance in 2020. Interim compliance is halfway between the baseline water use and 2020 target. Baseline, target, and compliance-year water use estimates are required to be reported in gallons per capita per day (gpcd).

For consistent application of the Act, DWR produced Methodologies for Calculating Baseline and Compliance Urban Water Per Capita Use in October 2010. By following requirements provided in this document, LADWP has calculated its baseline per capita water use, its urban use target for 2020, and its interim water use target for 2015. Reporting compliance with daily per capita water use targets is not required until the 2015 UWMP cycle as it compares the interim target to actual water use in 2015. Exhibit 3C presents results of the calculations. Calculations and the technical bases for each calculation are presented in Appendix G. LADWP's baseline per capita water use is 152 gpcd using a ten-year average ending between December 31, 2004 and December 31, 2009 and 145 gpcd using a five-year average ending between December 31, 2007 and December 31, 2009.

LADWP has selected Method 3 to set its 2015 interim and 2020 water use targets. LADWP investigated all four methods and selected Method 3 because it is the most straightforward and reliable calculation method that adequately accounts for the City's past conservation investments.

Method 3 requires setting the 2020 water use target to 95 percent of the applicable State hydrologic region target as provided in the State's Draft 20x2020 Water Conservation Plan. LADWP is within State hydrologic region 4, the South Coast region. LADWP was required to further adjust the calculated 2020 target to achieve a minimum reduction in water use. The gpcd at 95 percent of the hydrologic region was 142 gpcd and using 95 percent of the five-year average base daily per capita water use was equal to 138 gpcd. Therefore, LADWP was required to set its 2020 target at the smaller of the two resultant values. LADWP's interim 2015 target is 145 gpcd and LADWP's 2020 target is 138 gpcd.

### **3.2 Existing Programs, Practices, and Technology to Achieve Water Conservation**

LADWP has developed a number of progressive water conservation programs to address recently enacted State laws and to meet its goal of achieving an additional 50,000 AFY conservation by 2030. LADWP uses multiple programs, practices, and technologies in conjunction with enactment of State and local conservation ordinances and plumbing code modifications to achieve its current water conservation levels throughout its service area and customer classes.

### 3.2.1 State Laws and City Ordinances

---

#### State Laws

In addition to the Water Conservation Act of 2009 multiple legislative bills have been enacted in the past few years requiring water agencies to enact measures to increase water conservation, establishing new plumbing standards, and linking grants and loans to implementation of best management practices (BMPs).

The Water Conservation in Landscaping Act of 2006, Assembly Bill 1881, reduces outdoor water waste through improvements in irrigation efficiency and selection of plants requiring less water. The Act required an update to the existing Model Water Efficient Landscape Ordinance and adoption of this ordinance or an equivalent ordinance by local agencies no later than January 1, 2010. If any agency failed to adopt the ordinance or its equivalent, then the Model Water Efficient Landscape Ordinance was automatically mandated by statute. The ordinance requires development of water budgets for landscaping, reduction of erosion and irrigation related runoff, utilization of recycled water if available, irrigation audits, development of requirements for landscape and irrigation design, and scheduling of irrigation based on localized climate for new construction and redevelopment projects.

In 2009, Assembly Bill 1465, Urban Water Management Planning, was approved to include language in the UWMP Act requiring water suppliers that are members of the California Urban Water Conservation Council (CUWCC) and comply with its "Memorandum of Understanding Regarding Urban Water Conservation in California (MOU)" to describe their water demand management measures in their respective UWMPs. A more detailed discussion of the CUWCC and BMP compliance is provided in Section 3.2.3.

Assembly Bill 1420 links state funding for water management by urban water suppliers to implementation of water conservation measures. Urban water suppliers are required to be in compliance with the CUWCC MOU to be eligible for water management grants or loans. Senate Bill X7-7 further clarifies that the grant funding conditions required by AB 1420 will be repealed as of July 1, 2016 and replaced with eligibility determined by compliance with 20x2020 targets.

In the recent years, there have been numerous regulations approved that increase the water use efficiency requirements of plumbing devices, specifically, Assembly Bill 715 (2007), Senate Bill 407 (2009), and the CALGreen Building Standards. AB 716 requires that all toilet and urinal fixtures sold through retail or installed in existing and new residential and commercial building meet the high efficiency standards by January 1, 2014. SB 407 does not address the sale of plumbing fixtures but adds a requirement that beginning in January 1, 2017 all residential and commercial property sales must disclose all non-efficient plumbing fixtures. CALGreen has an effective date of January 1, 2011 and requires use of water efficient plumbing fixtures for all new construction and renovations of residential and commercial properties.

#### City Ordinances

Los Angeles has utilized ordinances as a tool to reduce water waste since 1988, beginning with the adoption of its first version of a plumbing retrofit ordinance. The ordinance mandated installation of conservation devices in all existing residential and commercial properties and installation of water-efficient landscaping in all new construction. Toilets were required to use less than 3.5 gallons per flush (gpf), urinals less than 1.5 gpf, and showerheads less than 2.5 gallons per minute (gpm). Customers with three acres or more of turf were required to reduce water consumption by 10 percent from 1986 levels or face a 100 percent surcharge on their water bills.

**Exhibit 3D  
Water  
Efficiency  
Requirements  
Ordinance  
Summary**

Device	Requirement
High Efficiency Toilets	1.28 gallons per flush
Urinals	0.125 gallons per flush
Faucets	
Indoor Faucets (Maximum)	2.2 gallons per minute
Private Lavatory Faucets	1.5 gallons per minute
Public Use Lavatory Faucets <sup>1</sup>	0.5 gallons per minute
Pre-rinse Spray Valve	1.6 gallons per minute
Showerheads	2.0 gallons per minute
Dishwashers	
Commercial Dishwashers	varies by type between 0.62 and 1.16 maximum gallons per rack
Domestic Dishwashers	5.8 gallons per cycle
Cooling Towers	5.5 cycles of concentration
Single-Pass Cooling Systems	Prohibited <sup>2</sup>

1. Metering faucets shall not deliver more than 0.25 gallons per cycle.

2. Single pass cooling systems are prohibited unless installed for health and safety purposes that cannot otherwise safely operate.

In 1998 the ordinance was amended, requiring the installation of ULF toilets and water saving showerheads in single-family and multi-family residences prior to the close of escrow. This progressive requirement is implemented with the help of local real estate professionals. LADWP has explored the expansion of the City's Retrofit on Resale Ordinance to include nonresidential properties.

Los Angeles further increased its water efficiency mandates in 2009 with adoption of the Water Efficiency Requirements Ordinance. This ordinance establishes water efficiency requirements for new developments and renovations of existing buildings by requiring installation of high efficiency plumbing fixtures in all residential and commercial buildings. Exhibit 3D summarizes the minimum requirements for new construction and replacement of fixtures in existing buildings.

In an effort to lead by example, LADWP has been retrofitting all its facilities with high efficiency plumbing fixtures since before the effective dates of the ordinance. As of early June 2010, LADWP is 57 percent complete in upgrading its 600 buildings to high efficiency faucets, toilets, urinals, showers, flexible hose connectors, angle valves, as well as correcting leaks and removing existing water damage.

In May 1996, the City's Landscape Ordinance (No. 170,978) became effective with an overarching goal to improve the efficient use of outdoor water. This ordinance was recently amended in 2009 to comply with the previously discussed Water Conservation in Landscaping Act of 2006 and the Model Water Efficient Landscape Ordinance.

LADWP first adopted an Emergency Water Conservation Plan Ordinance in the early 1990's in response to drought conditions. Subsequently in the current water shortage LADWP has adopted two amendments expanding prohibited uses, increasing penalties for violating the ordinance, and modifying water conservation requirements. Five phases of water conservation are incorporated into the plan with prohibitions and water conservation measures steadily increasing by phase. Regardless of water supply availability Phase I conservation requirements are in effect permanently unless a more stringent phase is in effect. In response to the ongoing water shortage conditions, LADWP implemented Phase III restrictions on June 1, 2009, restricting outdoor irrigation to two days per week. Following an ordinance amendment, Phase II implementation began on August 25, 2010 which allows outdoor watering three days per week. Exhibit 3E summarizes the five phases as defined in the latest amendment approved August 25, 2010.

**Exhibit 3E**  
**Emergency Water Conservation Plan Ordinance Restrictions by Phase**

Phase	Restrictions
I	No use of a water hose to wash paved surfaces
	No use of water to clean, fill, or maintain levels in decorative fountains, ponds, lakes or similar structures used for aesthetic purposes unless a recirculating system is used
	No drinking water shall be served unless expressly requested in restaurants, hotels, cafes, cafeterias, or other public places where food is sold, served, or offered for sale
	No leaks from any pipes or fixtures on a customer's premises; failure or refusal to fix leak in a timely manner shall subject the customer penalties for a prohibited use of water
	No washing vehicles with a hose if the hose does not have a self-closing water shut-off device attached or the hose is allowed to run continuously while washing a vehicle
	No irrigation during rain
	No irrigation between 9am and 4pm, except for public and private golf courses and professional sports fields to maintain play areas and event schedules. System testing and repair is allowed if signage is displayed.
	All irrigation of landscape with potable water using spray head and bubblers shall be limited to no more than ten minutes per water day per station. All irrigation of landscape with potable water using standard rotors and multi-stream rotary heads shall be limited to no more than 15 minutes per cycle and up to 2 cycles per water day per station. Exempt from these restrictions are irrigation systems using very low-flow drip-type irrigation when no emitter produces more than 4 gallons of water per hour and micro-sprinklers using less than 14 gallons per hour. This restriction does not apply to Schedule F water customers or water service that has been granted the General Provision M rate adjustment under the City's Water Rate Ordinance, subject to the customer having complied with best management practices for irrigation approved by LADWP.
	No watering or irrigation of any lawn, landscape, or other vegetated area shall occur in a manner that causes or allows excess or continuous water flow or runoff onto an adjoining sidewalk, driveway, street, gutter, or ditch.
	No installation of single-pass cooling systems shall be permitted in buildings requesting new water service.
	No installation of non-recirculating systems shall be permitted in new conveyor car wash and new commercial laundry systems.
	Operators of hotels and motels shall provide guests with the option of choosing not to have towels and linens laundered daily.
No large landscape areas shall have irrigation systems without rain sensors that shut off the irrigation systems.	
II	All prohibited uses in Phase 1 shall apply, except as provided.
	No landscape irrigation shall be permitted on any day other than Monday, Wednesday, or Friday for odd-numbered street address and Tuesday, Thursday, or Sunday for even-numbered street addresses. If a street address ends in 1/2 or any fraction it shall conform to the permitted uses for the last whole number in the address. For non-conserving nozzles (spray head sprinklers and bubblers) watering times shall be limited to no more than 8 minutes per watering day per station for a total of 24 minutes per week. For conserving nozzles (standard rotors and multi-stream rotary heads) watering times shall be limited to no more than 15 minutes per cycle and up to two cycles per watering day per station for a total of 90 minutes per week.
	Irrigation of sports fields may deviate from non-watering days to maintain play areas and accommodate event schedules with written notice from LADWP. However, a customer must reduce overall monthly water use by LADWP's Board of Water and Power Commissioners adopted degree of shortage plus an additional 5% from the customer baseline water usage within 30 days.
	If written notice is received from LADWP, large landscape areas may deviate from the non-watering days if the following requirements are met: 1) approved weather-based irrigation controllers registered with LADWP; 2) Must reduce overall monthly water use by LADWP's Board adopted degree of shortage plus and additional 5% from the customer baseline within 30 days; 3) Must use recycled water if available
	These restrictions do not apply to drip irrigation supplying water to a food source or to hand-held hose watering of vegetation, if the hose is equipped with a self-closing water shut-off device, which is allowed everyday during Phase II, except between the hours of 9am and 4pm.
III	All prohibited uses in Phases I and II shall apply, except as provided.
	No landscape irrigation shall be permitted on any day other than Monday for odd-numbered street address and Tuesday for even-numbered street addresses. If a street address ends in 1/2 or any fraction it shall conform to the permitted use for the last whole number in the address.
	No washing of vehicles allowed except at commercial car washes.
	No filling of residential swimming pools and spas with potable water.
	Irrigation of sports fields may deviate from non-watering days and be granted one additional watering days for a total of two watering days with written notice from LADWP. However, a customer reduce overall monthly water use by LADWP's Board of Water and Power Commissioners adopted degree of shortage plus an additional 10% from the customer baseline water usage within 30 days.
	If written notice is received from LADWP, large landscape areas may deviate from the non-watering days and be granted one extra day of watering for a total of 2 watering days if the following requirements are met: 1) approved weather-based irrigation controllers registered with LADWP; 2) Must reduce overall monthly water use by LADWP's Board adopted degree of shortage plus and additional 10% from the customer baseline within 30 days; 3) Must use recycled water if available
	These restrictions do not apply to drip irrigation supplying water to a food source or to hand-held hose watering of vegetation, if the hose is equipped with a self-closing water shut-off device, which is allowed everyday during Phase III, except between the hours of 9am and 4pm.
IV	All prohibited uses in Phases I, II, and III shall apply, except as provided.
	No landscape irrigation is allowed.
V	All prohibited uses in Phases I, II, III, and IV shall apply, except as provided.
	The LADWP Board of Water and Power Commissioners is authorized to implement additional water prohibitions based on the water supply situation.

Specific procedures for determining the initiation of a phase and termination of a phase are provided in the Emergency Water Conservation Plan Ordinance. Phases are initiated through recommendations provided by LADWP to the Mayor and City Council (Council).

### **3.2.2 Conservation Pricing**

In 1993, Los Angeles restructured its water rates to provide customers with a clear financial signal to use water more efficiently. It was the first time in LADWP's history that an ascending tiered rate structure was used. This conservation-based rate structure remains in use and applies a lower first tier rate for water used within a specified allocation, and a higher second tier rate for every billing unit (748 gallons) that exceeds the first tier allocation. A unique feature of the rate structure is that the first tier allocation considers factors that influence individual residential customer's water use patterns (i.e. lot size, climate zone, and family size).

The goals of LADWP's two-tiered water rate structure are to:

- Use price as a signal to encourage the efficient use of water
- Provide basic water needs at an affordable price
- Provide equity among customers
- Use price to stabilize water use during a shortage
- Generate adequate revenue for maintaining and upgrading the water system

In a period where increasing demands and reductions in water supply are becoming more commonplace, a rate structure that provides appropriate signals to

encourage efficient water use has become a necessity for many areas, including Los Angeles.

The substantial investments required for water quality improvements, security, and supply development have significantly raised the cost of delivering water. As rates increase, water agencies have noticed a change in use patterns. Because there is a known correlation between price and use, agencies use rates to encourage conservation activities and to postpone the need to construct new facilities or purchase even larger quantities of imported water.

LADWP's tiered rate structure, first implemented in 1993 with assistance from a broad-based group of stakeholders, applies a lower tier block rate for responsible water use within an allocated block of water, and a much higher rate for every billing unit above this block. The higher block rate reflects the "marginal cost," or the projected cost for additional water that would be required to meet these needs.

To further emphasize the conservation message, water charges are based solely on water used. This eliminates the inclusion of all fixed charges thereby allowing customers who use no water during a billing cycle to receive a bill that includes no charge for water service. There are automatic adjustments triggered when a water shortage exists. In June 2009, shortage year rates went into effect reducing first tier allocations for all customers by 15 percent (see Appendix C). These adjustments are based on the actual water use patterns that occurred during the 1991 period of mandatory water rationing. The purpose of these adjustments is to use price to encourage additional conservation and to provide LADWP with the revenue necessary to operate the system efficiently during a shortage.

### 3.2.3 CUWCC Best Management Practices

The CUWCC is the voice of urban water conservation in California, and LADWP has been active in the CUWCC since its inception in 1991. Instrumental in the development of the CUWCC MOU, LADWP was also one of the original signatories to this MOU. The MOU identifies BMPs as proven conservation measures as determined by the CUWCC. The most recent amendment to the MOU was adopted on June 9, 2010 updating compliance alternatives with the adopted BMPs. A water agency can now comply with the MOU through one of three methodologies: BMP compliance, accomplishing water conservation through a set of measures equal or greater than the water savings provided by the BMPs (Flex Track Menu), or accomplishing water conservation goals as measured in gpcd. All Group One (water suppliers) signatories to the MOU are committed to implement the BMPs.

Over the last 19 years, LADWP has played a significant role in the governance and policy making at the CUWCC, holding a seat on the Board of Directors, Strategic Planning Committee, By-Laws Committee, Research and Evaluation Committee, CII Committee, co-chair of the Membership Committee, and chair of the Group 1 Representation Selection Committee. LADWP also has been actively involved in all of the revisions that the MOU has undergone to date.

One of the obligations as a signatory to the MOU is to submit a Best Management Practices Retail Water Agency Report to the CUWCC. Previously submitted annually, this report is now submitted biennially and details progress in implementing the foundational and programmatic BMPs as currently specified in the MOU. LADWP actively implements the BMPs and the CUWCC BMP reports are available for review through the internet by accessing CUWCC's website at [www.cuwcc.org](http://www.cuwcc.org).

In the early 1990s, the State Water Resources Control Board identified urban water conservation as a major means for resolving problems in the Bay-Delta. Large water agencies, including LADWP, actively participated in work groups to develop conservation strategies. The result of this effort is in the aforementioned MOU.

The MOU commits signatory water suppliers to develop comprehensive conservation programs using sound economic criteria and to consider water conservation on an equal footing with other water management options. The MOU established the CUWCC to monitor implementation of the BMPs and to maintain the list of BMPs.

A BMP is defined as:

(a) An established and generally accepted practice among water suppliers resulting in more efficient use or conservation of water.

(b) A practice for which sufficient data are available from existing water conservation projects to indicate that significant conservation or conservation-related benefits can be achieved; that the practice is technically and economically reasonable and not environmentally or socially unacceptable; and that the practice is not otherwise unreasonable for most water suppliers to carry out.

LADWP implements all of the BMP requirements in the MOU that are applicable to retail water agencies like LADWP. Foundational BMPs are considered as essential BMPs for any water utility and are ongoing practices not subject to time limitations. Programmatic BMPs are minimal activities required to be completed by each utility within the timeframe of the implementation schedules provide in the MOU. A listing of the BMPs is shown in Exhibit 3F.

### Exhibit 3F CUWCC BMPs and Implementation Status

Category	Sub-category	Practices	Status
<b>Foundational</b>			
Utility Operations	Operations Practices	Maintain the position of a trained conservation coordinator	Implemented
		Prevent water waste – enact, enforce or support legislation, regulations, and ordinances	Implemented
		Wholesale agency assistance programs	Not applicable
	Water Loss Control Metering with Commodity Rates	Conduct Standard Water Audit and Water Balance	Implemented
		Measure performance using AWWA software	Implemented
		Locate and Repair all leaks and breaks	Implemented
		100% of existing unmetered accounts to be metered and billed by volume of use	Implemented
Conservation Pricing	Maintain a water conserving retail rate structure	Implemented	
Education	Public Information Programs	Maintain active public information program to promote and educate customers about water conservation	Implemented
	School Education Programs	Maintain active program to educate students about water conservation and efficient water use	Implemented
<b>Programmatic</b>			
Residential	Residential Assistance – provide leak detection assistance	Implemented	
	Landscape Water Surveys for residential accounts	Implemented	
	High efficiency clothes washer incentive program	Implemented	
	WaterSense Specification (WSS) for toilets	Implemented	
Commercial/ Industrial/ Institutional (CII)	Implement unique conservation programs to meet annual water savings goals for CII customers	Implemented	
Landscape	Implement Large Landscape custom programs	Implemented	
	Offer technical assistance and surveys upon request	Implemented	
	Implement and maintain incentive program(s) for irrigation equipment retrofits	Implemented	

### 3.2.4 LADWP Conservation Programs

LADWP develops cost effective programs to achieve multiple goals of cost-effective demand reduction, customer service, environmental responsibility, and compliance with CUWCC BMPs. Conservation potential is considered in determining program approach and duration. Some types of conservation programs result in savings that are more easily measured than others. LADWP’s programs include traditional demand-side management measures, as well as infrastructure improvement programs that contribute to water waste reductions. Demand-side management programs, like the rebate programs for water-saving toilets and high-efficiency

washing machines, produce results that are measurable. Public information, education, and other general conservation awareness programs are intended to alter customers’ behavioral patterns on water use and thus, are more difficult to quantify. It is such behavioral change in water use, however, that the City can point to as the primary reason for significant reduction in water consumption during water shortage periods. Combined with LADWP’s conservation pricing structure discussed in Section 3.2.2, these programs increase system reliability and efficiency and will provide a secondary benefit of reducing runoff.

LADWP dedicates numerous staff in support of the Water Conservation Programs. Key personnel include the full-time water conservation coordinator



who serves as LADWP's CUWCC representative, oversees conservation policies, and coordinates with other LADWP staff on the implementation of all the LADWP programs to ensure fulfillment with the annual water saving goals and CUWCC BMPs. Additional LADWP staff include the water conservation group that implement the various residential and commercial programs and the water conservation team (formerly known as the drought busters) that educate customers about the prohibited water uses, investigate claims of water waste and issue citations for water waste where warranted.

Specific conservation programs (past and present) associated with the CUWCC BMP categories are broken down in Exhibit 3G, and are fully discussed below. Appendix H contains the latest biennial reports provided to the CUWCC showing that LADWP has met all the BMP requirements.

### **Awareness/Support Measures**

Awareness/support measures can be active or passive. Active components include full metering of water use, assessment of volumetric sewer charges, and a conservation rate structure. Passive components typically include providing educational materials for schools, community and customer presentations, maintaining a conservation hotline, and a wide range of information distributed through customer bills, advertising in public venues, LADWP's website, and direct mail. Passive awareness/support measures provide the foundation for the conservation movement to build upon by raising water use awareness, water conservation program visibility, and encouraging community involvement.

In 2008, LADWP entered into an MOU with the Los Angeles Unified School District to further improve our water conservation outreach program. In FY 2009/10 LADWP budgeted approximately \$500,000 in funding for educational programs within area schools. Programs included:

- Los Angeles Times in Education – Provided newspapers to 50,000 students in grades 4-12 and lesson packages for teachers on supply sources and conservation.
- “Thirsty City” Live Performances – Play presented to more than 4,300 students introducing students to water supply sources, water supply challenges, and conservation.
- Renewable Energy and Conservation Curriculum – 660 teachers were trained in an extensive model conservation program reaching approximately 50,000 6<sup>th</sup> grade students.
- Renewable Energy and Conservation Center – Funding was provided for a science teacher position to set up and establish a Renewable Energy and Conservation Center with students to be bused to center for hands-on lessons focusing on conservation and renewable energy.
- Outdoor Education Multi-Day Environmental Experiences – Approximately 700 students in 20 classes in grades 4-12 attended two or three days of outdoor education experiences focusing on environmental measures, including lessons on energy and water.
- Eastern Sierra Institute – Training of 25 teachers over three days about the environment and geology of the Eastern Sierra.
- Teacher Fellowships – Ten math and science teachers from middle and high schools served in fellowships at LADWP for six weeks during the fall and summer of 2008 working in multiple offices with the intent of developing classroom lessons based on the experiences.
- Infrastructure Academy – 40 students from the Infrastructure Academy completed water conservation audits at 120 schools, including fixture

**Exhibit 3G  
Current  
and Past  
Conservation  
Programs**

CUWCC BMP Category	Conservation Measures	pre 1985	Year in Service
<b>Awareness/Support</b>			
	<b>Pricing</b>		
Utility Operations – Water Waste Prohibition	Retrofit on Resale Ordinance		1998
Utility Operations - Pricing and Operations	Tiered Rate Structure		1993
Utility Operations – Water Waste Prohibition	Drought Buster Program		1990
Utility Operations – Water Waste Prohibition	Emergency Water Conservation Plan Ordinance		1990
Utility Operations –Conservation Coordinator	Full-time dedicated staff to conservation	x	
Utility Operations - Metering	Full Metering and Volumetric Pricing	x	
Utility Operations - Pricing	Sewer Charge using Volumetric Pricing	x	
	<b>Public Information</b>		
	Drought Response Outreach		2008
	Hotel & Restaurant Water Conservation Campaign		2008
	ULFT Customer Satisfaction Survey		1992
	Advertising	x	
	Bill Inserts	x	
	Brochures	x	
	Community Involvement Program	x	
	Exhibits	x	
	Hotline	x	
	Speakers Bureau	x	
	<b>School Education</b>		
	LAUSD MOU		2008
	High School in concert with the Environment - Student Home Water/Energy Survey		1994
	Lower Elementary	x	
	Upper Elementary	x	
	Junior High	x	
<b>Residential</b>			
Residential	Residential Drought Resistant Landscape Incentive Program		2009
Residential	High Efficiency Clothes Washer Incentive Program		1998
Residential	Better Idea/Neighborhood Bill Reduction Service Program --Showerhead installation		1993
Residential	Community-Based Organization Toilet Distribution Centers, Direct Install		1992
Residential	High Efficiency Toilet Rebate		1990
Residential	Home Water Surveys		1990
Residential	Retrofit Kits Distribution		1988
<b>Commercial/Industrial/Government</b>			
Commercial/Industrial/Institutional	Commercial/Industrial Drought Resistant Landscape Incentive Program		2009
Commercial/Industrial/Institutional	Water Efficiency Requirements Ordinance		2009
Commercial/Industrial/Institutional	General Services Dept. MOU to Retrofit Plumbing		2009
Commercial/Industrial/Institutional	Public Agency Plumbing Audit and Training Program		2009
Education - Public Information Programs	Targeted Literature Mailing		1993
Commercial/Industrial/Institutional	Commercial/Industrial Conservation Guidebook		1992
Commercial/Industrial/Institutional	Cooling Tower Manual and Workshops		1992
Commercial/Industrial/Institutional	Commercial Rebate Program		1991
Commercial/Industrial/Institutional	Interior Water Use Audits		1991
Commercial/Industrial/Institutional	Technical Assistance Program (TAP)		1991
Landscape; Commercial/Industrial/Institutional	Typical Audits		1991
<b>Landscape</b>			
Landscape	Recreation and Parks MOU		2007
Landscape	Large Turf Irrigation Controller Pilot Program		2000
Landscape	Protector del Agua -- English and Spanish Language Workshops		1995
Landscape	Improving Irrigation Performance Manual & Workshop		1993
Landscape	Large Turf Audits and Audit Training		1993
Education - Public Information Programs	Lawn Water Guide Direct Mailing (as requested)		1989
Education - Public Information Programs	Demonstration Gardens		1988
Landscape	Ten Percent Large Turf Water Reduction Program		1988
<b>System Maintenance Measures</b>			
Utility Operations - Water Loss Control	Large Meter Replacement Program		2001
Utility Operations - Water Loss Control	Fire Hydrant Shutoffs		1991
Utility Operations - Water Loss Control	Meter Replacement Program		1988
Utility Operations - Water Loss Control	Cement Mortar Lining of Pipelines	x	
Utility Operations - Water Loss Control	Corrosion/Cathodic Protection	x	
Utility Operations - Water Loss Control	Infrastructure Program	x	

counts, analysis of toilet makes and models, and analysis of irrigation controllers and field conditions.

Included within the short-term strategies of the City of Los Angeles' Water Supply Action Plan is a strategy to increase water conservation in the City through an aggressive \$2.3 million conservation education campaign. LADWP Public Affairs Office implemented a media campaign that included radio, TV, and newspaper advertisements, billboards, outreach to Neighborhood Councils; and marketing of City rebates for water-efficiency.

Another aspect of awareness/support is that of advocacy. LADWP has been instrumental in the development of more stringent standards for toilets (e.g. Supplementary Purchase Specification for ULF toilets) that are in use within the City as well as by other water agencies in California and other areas. LADWP also assisted in the adoption of higher residential clothes washer efficiency standards by the California Energy Commission. Recognizing the importance of this activity, LADWP actively participates in advocating local and statewide conservation research and planning.

## Residential Category

Multiple residential conservation programs were first developed and launched by LADWP during the drought of 1987 through 1992. In 1990, the ULF Toilet Rebate Program was initiated, followed two years later by the ULF Toilet Distribution Program. In 2003, a well-received free installation service component was added to the ULF Toilet Distribution Program that included free water-saving showerheads, faucet aerators and replacement toilet flapper valves. Today distribution of free faucet aerators and showerheads continues for all single-family, multi-family, and commercial customers.

In 2008 MWD initiated the region-wide SoCal Water\$mart Program for residential water conservation. This

program replaced previous LADWP rebate programs and rebate programs offered by individual water service providers throughout the MWD service area. This MWD sponsored program sets uniform rebate requirements across the MWD service area and provides a clearinghouse for processing rebates for all MWD member agency customers. Local agencies have the option of supplementing baseline rebate amounts to their customers through the program. LADWP has increased baseline rebates for several of the qualifying products. Eligible customers include residential customers residing in single-family and multi-family homes, even if multi-family residents do not receive a water bill.

Although the SoCal Water\$mart Program has discontinued rebates for high efficiency toilets (HET), LADWP continues to provide local funding for rebates for its customers of \$100 per HET which has proven to be highly successful with over 1,900 units installed in FY 2009/10 which equates to over 80 AFY in water savings.



Prior to initiation of the SoCal Water\$mart Program, LADWP was assisted by community-based organizations (CBOs) to reach the milestone of more than 1.27 million toilets installed through December 31, 2006. CBOs were integral to LADWP's success, reaching into the communities they serve to convey the conservation message and directly undertake conservation activities. Benefits of this approach accrued to community participants through reduced water bills, to CBOs through employment opportunities and revenues earned, and to the City through significant water savings achieved. Prior to its discontinuation, the program was funded at more than \$7 million annually. The toilets replaced through the program continue to produce estimated water savings of more than 44,000 AFY today.

LADWP initiated a High Efficiency Washer Rebate Program in 1998 promoting the purchase and installation of high efficiency washing machines saving both water and energy. As of January 2009, rebates have been paid for more than 66,100 machines purchased and installed throughout the City. The program's minimum efficiency requirements for rebate eligibility were increased in January 1, 2004, resulting in the promotion of higher efficiency models. Initial co-funding of the program was provided by the City's Department of Public Works Bureau of Sanitation and by the Southern California Gas Company.

In February of 2009 the High Efficiency Washer Rebate Program transferred from LADWP to the SoCal Water\$mart Program with co-funding provided by MWD. Since the inception of the SoCal Water\$mart Program and through June 2010, over 11,800 rebates for washing machines were issued to LADWP customers with a total annual savings of 368 AFY. Generally rebates are \$300 per washing machine with a water factor (a measure of efficiency) of 4.0 or less. From April 22, 2010 through December 6, 2010, an additional \$100 rebate was available through the California Cash for

Appliances program for a total rebate of \$400 per washing machine.

A sprinklerhead rotating nozzle retrofit rebate of \$8 per nozzle is available through the SoCal Water\$mart Program for a minimum of 25 nozzles. Replacing standard sprinkler heads with rotating nozzles can use up to 20 percent less water. Rotating nozzles are able to distribute water in a water-efficient manner more uniformly across a landscape than standard sprinklers. Spray from rotating nozzles is less likely to result in misting conditions, misdirection from winds, and reduces runoff onto pervious surfaces thus reducing dry-weather runoff. Between March 2009 and June 2010 2,878 rotating nozzle rebates were issued to LADWP customers saving approximately 12.7 AFY.

Rebates for installation of weather-based irrigation controllers are also available through the SoCal Water \$mart Program. Rebates amounts are \$200 per controller for landscape areas of less than one acre and \$25 per station for landscape areas greater than one acre. Weather-based irrigation controllers provide customized irrigation schedules based on local site conditions and in response to weather changes. These smart controllers receive weather updates to automatically adjust the schedule and amount of water applied. Between March 2009 and June 2010 81 LADWP customers received rebates for installation of the controllers saving approximately 6.2 AFY.

Initially a synthetic turf rebate program was offered through the SoCal Water\$mart Program, but has been discontinued as of June 1, 2010. The program provided rebates of \$1.00 per square foot. Approximately 316,547 square feet of synthetic turf was installed by LADWP customers between February 2009 and June 2010 saving approximately 44.3 AFY.

LADWP through the SoCal Water\$mart program is offering turf removal rebates of \$1 per square foot up to \$2,000

per residence. Not all MWD member agencies are participating in the turf removal program and participating agencies have additional requirements beyond MWD's requirements. Areas targeted for turf removal must currently be turf irrigated with potable water for a minimum of one year. All replacement materials must be permeable and either hand watered or irrigated with drip irrigation. A minimum of 250 square feet must be converted to be eligible for a rebate. No invasive plants are permitted and all exposed soil must be covered with mulch. Synthetic turf is an acceptable replacement if it is not used in right of ways or parkways. Applicants are required to maintain the converted area for ten years. The program commenced in December 2009, and as of FY 2009/10, over 280,000 square feet of turf area has been converted saving over 39 AFY. In conjunction with the turf removal program, LADWP is conducting a drip system pilot program and is offering free residential drip starter kits.

Water-saving showerheads and faucet aerators remain available to LADWP customers, free of charge, upon request. Approximately 12,124 showerheads and 14,792 faucet aerators were distributed between July 2007 and June 2010 saving approximately 241 AFY. During past water shortages, more than 1.5 million water conservation retrofit kits were distributed throughout Los Angeles; the kits included one-gallon toilet displacement bags, low-flow showerheads, and toilet leak detection tablets.

As part of past programs promoting residential water conservation measures, students conducted home water surveys through a resource efficiency education program implemented by LADWP in Los Angeles area high schools. Additionally, local community based organizations visited many Los Angeles residences throughout the year, assessing water conservation opportunities in the home and installing applicable measures to immediately capture water savings.

Another element of LADWP's past efforts was a toilet flapper valve replacement pilot program. Although long-term water savings from ULF toilets are predicated on timely replacement of leaking toilet flapper valves with appropriate replacement units, findings from the pilot program indicate a small incidence of leaking flapper valves in toilets rebated or distributed by LADWP. However, toilet leak testing and flapper valve replacement was added to the past ULF Toilet Distribution Program's installation service component for toilets not replaced through the program.



### **Commercial/Industrial/ Institutional (CII) Category**

This category represents some of the largest volume water users in LADWP's customer base, and represents a great deal of conservation potential. LADWP, in partnership with MWD, developed and has implemented a commercial rebate program entitled the Save Water Save a Buck Program, designed specifically for customers in the CII sector and multi-family residences with five or more units represented by a homeowners association. In the CII sector, the program provides rebates for water saving plumbing fixtures, food service equipment, and landscaping equipment. Within the multi-family sector the program provides rebates for high efficiency washers, high efficiency toilets, and landscape equipment. In addition, packaged water use efficiency solutions are being developed for specific business sectors. Efforts are also underway to better promote the financial incentives

**Exhibit 3H**  
**CII Conservation Programs and Savings July 2007 through June 2010**

Device Type	Rebate Amount	Devices Installed	Estimated Annual Savings (AFY)
	Retrofit		
<b>Save Water Save a Buck Program</b>			
Current Programs			
High Efficiency Toilets (1.28 gpf or less)	\$150 each (\$50 new construction)	58,432	2,408.60
Zero and Ultra Low Water Urinals	\$500 each (\$250 new construction)	6,063	630.9
Cooling Tower pH Conductivity Controller	\$3000 each	41	79.7
Cooling Tower Conductivity Controller	\$625 each	57	36.7
Air Cooled Ice Machine	\$300 each	0	0
Connectionless Food Steamer	\$600 compartment	23	5.8
Dry Vacuum Pump (maximum 2.0 horsepower)	\$125 per 0.5 horsepower	8	0.7
Water Broom	\$150 each	73	11.2
Weather Based Irrigation Controller	\$50 per station	391	127.1
Central Computer Irrigation Controller	\$50 per station	0	0
Rotating Nozzles for Pop-up Spray Heads (25 minimum)	\$8 each	22,534	99.1
High Efficiency Spray Nozzles for Large Rotary Sprinklers	\$13 per head	8,558	308.1
Past Programs			
High Efficiency Coin Clothes Washer	-	1,738	186.8
Pre-Rinse Sprayhead	-	5	0.8
Steam Sterilizer Retrofit	-	6	7.8
X-Ray Processor Recirculation System	-	1	3.2
Synthetic Turf (square feet) <sup>1</sup>	-	15,177	2.1
<b>Subtotal Save a Buck Program</b>	-		<b>3,908.70</b>
<b>LADWP Inhouse Programs</b>			
Commercial Showerheads	-	5,180	85.3
Commercial Faucet Aerators	-	20,844	96.5
Water Brooms	-	262	40.2
CII Landscape Program Turf Removal <sup>2</sup>	-	1,251,043	95.6
Technical Assistance Program <sup>3</sup>	-	-	2358.4
<b>Subtotal LADWP In-house</b>	-		<b>2676</b>
<b>Total CII</b>	-		<b>6584.8</b>

1. Synthetic Turf rebates as of June 1, 2010 are available through LADWPs Technical Assistance Program.

2. Rebate amount varies and is determined during pre-approval process.

3. Rebates for Technical Assistance Program are \$1.75 per 1,000 gallons saved over a two year period with a cap not to exceed the actual cost of the project. Devices installed vary per project.

available that make water conservation retrofits more cost effective for business and industry. LADWP takes full advantage of regional programs offered through MWD for the CII sector and for many product rebates, provides supplemental funding to boost the base rebate provided by MWD.

The Save Water Save a Buck Program was launched in 2001 to provide menu-based rebates for water conserving measures applicable to many types of CII facilities. Categories of products eligible for rebates, rebate amounts, number of rebates for the LADWP service area, and estimated savings are provided in Exhibit 3H for the period July 2007 through June 2010. During this period, an estimated annual savings of 6,585 AFY was achieved, inclusive of LADWP in-house programs and the Technical Assistance Program (TAP). The program design provides for ease of participation and has been well-received by LADWP customers. The program has been so successful that the SoCal WaterSmart Program for residential customers was modeled after it.

LADWP created the Technical Assistance Program (TAP) in 1992 to provide custom-type incentives for retrofitting water-intensive equipment. Different from the Save Water Save a Buck Program, the TAP encourages site-specific projects and TAP incentives are based on a given project's water savings. Financial incentives up to \$250,000 are available for products demonstrating water savings. Incentives are calculated at the rate of \$1.75 per 1,000 gallons saved over a two-year period with a cap not to exceed the actual cost of the installed product. Projects must save a minimum of 150,000 gallons over a two-year period and operate for a minimum of five years. Eligible customers are CII or multi-family residential customers. Past TAP projects include cooling tower controller upgrades and x-ray processor recirculation systems. The estimated unit cost for TAP overall is about \$228 per acre-foot saved with an annual savings of 2,358.4 AFY based on projects installed between July 2007 and programs until June 2010.

Similar to the residential turf removal program, LADWP has a turf removal program for commercial properties. This program started in September 2009 and the rebate is \$1.00 per square foot of turf with the total project rebate amount as defined in the pre-approval letter provided by LADWP. Areas targeted for conversion must have live healthy turf irrigated with potable water (recycled water is ineligible) via automatic sprinkler valves when a project approval letter is provided by LADWP. Converted areas must contain enough plants to create at least 30 percent landscape coverage at maturity. Converted areas may not contain turf or synthetic turf (synthetic turf rebates are available through the TAP). All replacement materials must be permeable and plants must be climate appropriate or California native plants. A minimum of 250 square feet must be converted to be eligible for a rebate. No invasive plants are permitted and all exposed soil must be covered with three inches of mulch. If an irrigation system is used it must be a low flow drip or bubbler system. Applicants are required to maintain the converted area for 15 years.

Water-saving showerheads and faucet aerators are available to LADWP commercial customers, free of charge, upon request. Bathroom faucet aerators are provided in 1.5, 1.0, or 0.5 gallons per minute (gpm), kitchen faucet aerators are provided in 1.5 gpm, and showerheads are provided in 2.0 gpm. Approximately 5,180 showerheads and 20,844 faucet aerators were distributed between July 2007 and June 2010 saving approximately 181.8 AFY combined. LADWP additionally offers an in-house water broom program in addition to the rebates offered through the Save Water Save a Buck Program.

### **Landscape Category**

Recognizing that a substantial amount of water is used outdoors for irrigation, LADWP continues to invest in landscape irrigation efficiency programs and projects. In addition to the previously discussed landscape ordinances (Section 3.21.), LADWP has sponsored free



Drought-tolerant garden outside the LADWP John Ferraro Building.

training courses specifically targeting the City's large turf customers to help these customers comply with the landscape ordinance. To further assist this group, LADWP developed a guidebook, "Improving Irrigation Performance" to demonstrate ways for enhancing existing irrigation systems.

LADWP has also sponsored conservation and garden expos to highlight various aspects of efficient outdoor water use and planting practices, and emphasize native, drought-tolerant plants. Funding was provided for three demonstration gardens to showcase the use of drought-tolerant plants and flowers, including the landmark Lummi Home in Highland Park. Lawn watering guides were mailed to all single-family and duplex residences. Planting guides for native and drought-tolerant plants are also available upon request. Additionally, to demonstrate the beauty and appeal of a water-conserving landscape, LADWP's John Ferraro Building facility (below) has a drought-tolerant garden that is open to visitors year-round.

In addition to the Residential and Commercial Landscape Incentive Programs for turf removal, other types of landscape irrigation improvement projects are also funded through the TAP, with incentives calculated on the basis of a project's water savings. LADWP staff includes certified landscape auditors, and large landscape audits are available upon request.

LADWP is also investigating new programs using data obtained through pilot program efforts. A pilot program was conducted to determine the effectiveness of weather based irrigation controllers in large landscape applications. On the basis of the pilot program results showing water savings, financial incentives are available to LADWP customers for the purchase and installation of weather based irrigation controllers through the SoCal Water\$mart and Save Water Save a Buck Programs. Additional efforts are being undertaken to make available a landscape irrigation education program for homeowner associations and other large landscape customers. This program would focus on common green areas



in multi-unit complexes to improve irrigation efficiency, including irrigation system maintenance and repair, and plant selection.

LADWP has been implementing an internal program to retrofit outdoor landscaping at department-owned facilities to California-friendly and native plantings with efficient irrigation systems. Additionally, a joint effort between the Department of Recreation and Parks and LADWP is targeting public parks through the City Park Irrigation Efficiency Program. City parks with inefficient irrigation systems, leaks, and runoff problems are identified and upgraded with water efficient distribution systems and sprinkler heads, installation of smart irrigation controllers, and planting of California-friendly landscaping. Since the program began in 2007, seven parks have been completed and 4 new weather stations have been installed. An additional benefit of this program is the educational, trade training, and employment opportunity given to the youth of Los Angeles.

There is also potential for the use of non-potable water for irrigation, which can help extend the utility of the City's traditional water supplies. Through increased stormwater capture, groundwater recharge with captured storm and irrigation runoff, and recycled water, imported surface water and local groundwater used for landscape irrigation can be conserved. The potential to use such non-potable water supplies is further discussed in the Recycled Water and Watershed Management chapters (Chapters 4 and 7 respectively).

New Low Impact Development (LID) projects implemented within the City and innovative work by non-profit organizations demonstrate pioneering ways to conserve water for landscapes. As discussed in Chapter 7, LADWP's Watershed Management Group is proactively developing programs in conjunction with other departments to highlight water conservation through LID

and implementing stormwater BMPs. A local non-profit, TreePeople, has partnered with various City departments, including LADWP on a number of stormwater capture projects.

For over a decade, TreePeople has demonstrated that rainwater is a viable local water resource. The Open Charter Elementary School Stormwater Project is one of several sustainable stormwater management systems that TreePeople installed in Los Angeles. Other examples include: the Center for Community Forestry which harvests rainwater from its entire hardscape into a 216,000 gallon underground cistern for landscape irrigation use; a retrofitted single-family residential home in South Los Angeles that captures a 100-year storm event on site; and a 7,600 square foot subsurface stormwater infiltration gallery on the Broadous Elementary School campus in Pacoima. Most recently, TreePeople partnered with the Los Angeles and San Gabriel Rivers Watershed Council, LADWP, and other state and federal agencies to retrofit an entire residential block on Elmer Avenue in Sun Valley. This project now intercepts stormwater from 40 acres upstream and infiltrates it back to the aquifer while also demonstrating effective distributed stormwater BMPs on residential homes.

In partnership with the Los Angeles County Department of Public Works, TreePeople was instrumental in developing the Sun Valley Watershed Management Plan: an alternative stormwater management plan that prioritizes green infrastructure and multi-benefit stormwater capture projects instead of stormdrains. Many projects have been completed, and more are scheduled for construction. These activities create the foundation that will lead to further landscape water conservation and stormwater capture to increase the water use efficiency of the City's limited water supplies.

## CASE STUDY: Los Angeles River Revitalization and the North Atwater Park Project

### **Background**

The Los Angeles (LA) River flows 51 miles through some of the most diverse communities in Southern California—its first 32 miles are within the City of LA. The River has a year-round low flow due to contributions from upstream wastewater treatment plants, urban runoff, groundwater inflow, and natural springs, but can become a torrent of racing flows during the rainy season. The River is almost entirely concrete-lined except for a few reaches. Although the design of the River has served its flood control purpose, the River holds far greater potential to serve as a focal point for environmental restoration, economic growth, community revitalization, and recreation.

Realizing that the River should stand as a symbol of pride for the City of LA and its residents and that it should be a landmark for the public to enjoy and admire, the LA City Council established the Ad Hoc Committee on the River in 2002 and adopted the LA River Revitalization Master Plan (LARRMP) in 2007 ([www.lariver.org](http://www.lariver.org)). Led by the City's Bureau of Engineering and funded by the LA Department of Water and Power, the LARRMP was created through a collaboration of elected officials, city departments and agencies, residents, multi-disciplinary experts, and a wide variety of private and non-profit environmental and recreational groups. The LARRMP is a 25-to-50 year blueprint for transforming the City's stretch of the LA River into an extensive network of parks, walkways, bike paths, and diverse land uses that will ensure the growth and sustainability of healthy communities.

### **Key Features**

In October 2010, the City celebrated the groundbreaking of the North Atwater Park Expansion and Creek Restoration project as the first project to emerge from the LARRMP, which is expected to be open to the public by December 2011. The project was undertaken in connection with the settlement of two Clean Water Act enforcement action, *Santa Monica Baykeeper v. City of Los Angeles and United States*, and *State of California ex. Rel. California Regional Water Quality Control Board, Los Angeles Region v. City of Los Angeles* and also funded in part by Proposition 50 through the California Resources Agency to improve River Parkways and the Integrated Resources Water Management. The project will use both structural and natural solutions to restore a degraded creek that is a tributary of the River while also expanding River-adjacent parkland with multiple recreational, wildlife habitat, and water quality benefits. The project will add nearly 3 acres to an existing 5-acre City park, connecting it to the River, where visitors will enjoy watching a wide variety of bird species that presently live in that soft-bottomed stretch of the River, framed by stunning views of Griffith Park in the distance. Some of the project's highlights include:

### **Outdoor Classroom**

The project will encourage young children to explore nature via an educational gathering space near the LA River. This "outdoor classroom" will feature a nature-based art area for independent and guided activities—designed particularly for local students to learn about nature, native plants, and the opportunities and challenges associated with revitalizing the LA River.

### **Native Demonstration Garden**

The park's central focus will be a demonstration garden, which will contain a variety of native plants that are used throughout the park, with interpretive displays to educate visitors about the plant species' characteristics, care, and relationship to water conservation. The park will only include native plants because they are considered "drought-tolerant" given their abilities to thrive in Southern California's climate, requiring much less water than other plants. The park's landscape design aims to set an example in the use of such plants, but also to educate the public on the merits of embracing native vegetation as an important component of solving the region's water crisis.

### **Creek Restoration**

North Atwater Creek currently conveys polluted runoff to the River from an upstream stormdrain system that receives flow from a 40-acre urban area. The Creek will be restored and landscaped with native plants to prevent erosion and to naturally filter stormwater before it is discharged to the River, featuring a 1000-foot-long meandering streambed sustained by intermittent street runoff flows. Water quality improvements will include installation of a device at the entrance of the creek to intercept and capture trash and bacteria and special treatment of flows from adjacent equestrian facilities.

### **Accommodating Visitors**

While the park's landscape design capitalizes on the opportunity to educate visitors about the many connections between urban life, nature, and water, its structural features do also. For example, the parking lot will be transformed by installing a gravel bioswale along the borders and replacing existing parking spaces with permeable surfaces. These changes will not only address surface water contamination, but also allow stormwater to infiltrate so that it will assist with groundwater augmentation.



## System Maintenance Category

Maintaining system infrastructure reduces water waste and allows for greater water accountability. Infrastructure maintenance is a high priority for LADWP. As discussed in Chapter 2, LADWP non-revenue water has an impressive historical 25-year average of 7 percent of the total water demand. LADWP maintains a 24 hour, 7 days per week leak response operation and repairs major blowouts that impact public safety immediately and typical leaks within 72 hours. Ongoing programs such as pipeline replacement, pipeline corrosion control, and meter replacement preserve the operational integrity of City water facilities, and aims to reduce unaccounted water losses.

In recent years, the LADWP has ramped up its pipeline replacement program from 70,000 linear feet annually to 95,000 linear feet annually. Additionally, the LADWP Water System's Asset Management Group along with the Water Distribution Division are working to develop a predictive model that uses existing data relative to the factors which contribute to water main deterioration to determine a replacement priority for all pipe segments in the system. The results of this model along with criticality assessments and leak history can be used to focus replacement resources on pipe segments that are more likely to fail and disrupt service levels.



LADWP has also made significant progress in replacing and/or retrofitting water meters through its meter replacement program that started in 1988. As a result of extended flow or usage, the moving parts in a water meter can wear down and begin to under-register the actual water consumption. The meter replacement program has been valuable in ensuring the accuracy of the approximately 700,000 meters within the City. Recently, all of the large-sized meters (3-in and larger) in the system were replaced as part of a Large Meter Replacement Program, and the LADWP is also replacing 35,000 small meters annually.

As part of the new requirements of the CUWCC Water Loss Control BMP amended in September 2009, LADWP has completed training in the American Water Works Association water audit method and component analysis process offered by CUWCC. LADWP has also completed the standard water audit and balance using the American Water Works Association Water Loss software to determine the current volume of apparent and real water loss and the cost impact of these losses. As the final BMP condition, LADWP is on target to complete the required component analysis by July 2013. The goal of the component analysis is to identify volumes of water loss, the cause of the water loss and the value of the water loss for each component.



### **3.3 Future Programs, Practices, and Technology to Achieve Water Conservation**

LADWP, on its own and in cooperation with other agencies, continues to investigate future programs, practices, and technology to improve water conservation.

#### **3.3.1 Graywater**

As defined by State regulations, graywater is untreated household wastewater that has not come into contact with toilet waste or unhealthy bodily wastes. It includes

water sources from bathtubs, showers, bathroom wash basins, and water from clothes washing machines and laundry tubs. It specifically excludes water from kitchen sinks and dishwashers. Graywater is a drought-proof source of supply for subsurface landscape irrigation. Graywater regulations do not allow for its application using spray irrigation. Graywater is also not allowed to pond or runoff, discharge to or reach a storm drain system or surface water body, and is not permitted for irrigation of root crops or edible food crops that are directly in contact with the surrounding soil.

The Graywater Systems for Single Family Residences Act of 1992 legally incorporated the use of graywater as part of the California Plumbing Code. In September 1994, the City approved an

ordinance that permitted the installation of graywater systems in residential homes. However, installing graywater systems under this act was costly in terms of both installation and maintenance. To address the current water shortage and reduce water demands, emergency graywater regulations added Chapter 16A (Part I) "Nonpotable Water Reuse Systems" to the 2007 California Plumbing Code. These regulations were approved by California Building Standards Commission in 2009 and became effective on August 4, 2009. Further revisions were made to the regulations and the regulations became permanent on January 12, 2010 with an effective date of January 20, 2010. These new code changes allow the use of certain types of untreated graywater systems as long as specific health requirements are met as defined by the authority having jurisdiction. The ordinance can be acquired from the City of Los Angeles Department of Building and Safety (LADBS) website at the following link.

[http://ladbs.org/LADBSWeb/LADBS\\_Forms/InformationBulletins/IB-P-PC2008-012Graywater.pdf](http://ladbs.org/LADBSWeb/LADBS_Forms/InformationBulletins/IB-P-PC2008-012Graywater.pdf)

Graywater systems in residential buildings are regulated by LADBS. LADBS requires a plumbing permit prior to construction, reconstruction, installation, relocation, or alteration of any graywater systems, treated or untreated. As of FY 2009/10, LADWP does not offer any rebates or incentives for graywater systems, but continues to assess the potential for this water conservation technology. LADWP is also reviewing the concept of assisting in the creation of ad hoc committees to develop a standard for graywater systems.

### **Untreated Graywater Systems**

Untreated graywater systems are systems where graywater is collected from non-toilet and non-kitchen sources and is utilized without treatment, for uses such as landscape irrigation. According to a 1999 study prepared by the Soap

and Detergent Association, the average untreated graywater system in the US uses 6.3 gallons per day. In a 2010 White Paper prepared by Bahman Sheikh, for the WaterReuse Association, Water Environment Federation, and American Water Works Association the potential for graywater generation in 2030, adjusted for conservation devices, is estimated at approximately 75.5 gallons per household per day. Potentially 50 percent of indoor potable water use could be re-used as graywater. Multiple manufacturers have developed untreated graywater systems and many households have installed such systems. However, these systems are not typically monitored, thus health and safety risks associated with the products have not been determined.

Under the recently approved revisions to the graywater system regulation, LADBS does not require a permit for untreated graywater systems supplied by only a clothes washer in a one or two-family dwelling as long as the system does not require modification of existing plumbing. Multiple requirements must be met for a system to be exempt from a permit, including but not limited to:

- Discharge shall be released not less than two inches below the surface of rock, mulch, or soil.
- Designs shall incorporate a means to allow the user to divert flow to the disposal area or the building sewer.
- Design of the system shall not allow contact with humans or pets.
- Water from diapers or other similarly soiled or infectious garments shall be diverted to the building sewer.
- Hazardous chemicals from washing activities, such as soiled rags, shall be diverted to the building sewer.
- An operation and maintenance manual shall be provided and remain with the building.

## CASE STUDY: Single-Family Home Graywater System

As a community environmental leader, Janie Thompson is taking extraordinary steps in efficient use of water and conservation. With the help of her husband, her household has become an excellent example of a rainwater capture residence, catching rain in 18 separate rain barrels with 60 gallons each. To save even more water, the couple is installing an impressive graywater network, distributing water to the furthest extent of their large 14,850 square foot property.



*"In June 2009, when the Mayor announced the ordinance limiting watering to two days per week, we freaked out, and originally thought most of our landscaping would die. With all of our conservation, rainwater capture, and use of graywater, our usage has dropped from 117 hcf to around 54 hcf per month in the summer months. We couldn't be happier. It just goes to show you how much most people in the City over water." – Janie Thompson*

Their existing graywater system currently uses the drainage pump from the clothes washer to pump water slightly up grade to tree and flower areas of the backyard. Upon exiting the washer, a 3-way valve reserves the option to divert washer effluent to the sewer system. The graywater piping travels beneath their raised foundation home, into the subsoil, and onto the areas it serves. Once construction is complete, all piping (left) will be buried with existing soil or mulch.



When the stream is pumped to the highest point of the yard, it is sent to numerous subsoil infiltration chambers, through a distribution system of 1" HDPE (High-density polyethylene) pipe. The infiltration chambers are made from 1 gallon paint buckets turned upside down with holes cut in the bottoms (below). The chambers allow for unobstructed exit flow and appropriate soil surface area for infiltration. In addition, they provide a significant volume for water storage during the surge of a pumped load of laundry. Plant roots are attracted toward these water outlets, essentially feeding on nutrients and organics in the graywater. The tops of the chambers are cutout for frequent access, and covered with mulch or stepping stone. The pipe exits can be checked as necessary to ensure free flow.



The next steps in the construction are connection of the bathtub and bathroom sinks. Effluent from these water sources will enter a surge tank and float switch assembly. A graywater dedicated pump will then automatically push water to existing and newly installed infiltration chambers throughout the yard.

Graywater used from these indoor sources will provide two main benefits. It will displace water used for irrigation and prevent additional water from entering the sewer. This decreases the load on the City sewer system and lowers the overall cost of treatment for the Bureau of Sanitation.

The water savings are approximated in the following table. Please note that the clothes washer is a high-efficiency front loading model. Showers are estimated at 10 minutes long with a showerhead using 2.5 gallons per min.

Yearly Water Savings				
<b>Washer</b>	14 gal/use	10 uses/wk	140 gal/wk	7,280 gal/yr
<b>Bathtub</b>	40 gal/person/day	3 people	840 gal/wk	43,680 gal/yr
<b>Bath Sink</b>	2 gal/person/day	3 people	42 gal/wk	2,184 gal/yr
<b>Total</b>				53,144 gal/yr

### Treated Graywater Systems

Treated graywater systems treat water collected from non-kitchen and non-toilet sources for nonpotable reuse indoors and outdoors. Treated graywater systems for indoor use of graywater are not currently permitted by LADBS as there are no water quality standards nor mean to certify onsite treatment systems. Testing agencies are working to address safety concerns while manufacturers are working to improve the technology gap in the systems. Both manufacturers and testing agencies are working together to address gaps in standards to allow the future use of treated graywater for outdoor surface irrigation and for indoor uses in toilets and urinals.

The National Center for Disease Control and Prevention in conjunction with North Carolina State University is developing a program to examine the public health values and impacts associated with decentralized water reuse at eight project sites across the country. Under this program wastewater from homes

would be treated to Title 22 standards as required by local health regulators. One of the proposed sites is located in Los Angeles County.

On the international level, treated graywater systems are used in both Europe and Australia. However, treated graywater systems in the United States are not common. A lack of accepted standards for graywater systems imposes a financial risk to companies manufacturing graywater systems. The International Association of Plumbing and Mechanical Officials (IAPMO) and NSF International are the two testing agencies working to develop standards for uniform treated graywater systems applicability in the US. LADWP is closely following the development of the NSF Standard 350 and IAPMO standards to ensure that once a set of standards have been approved by model codes and adopted by the Building Standards Commission, the citizens of Los Angeles can safely install treated graywater systems to maximize water reuse without any health and safety risks.



### 3.3.2 Demand Hardening

---

Although LADWP regularly assesses new water conservation opportunities, conservation programs may, at some point in time, diminish a customer's ability to further conserve water, in particular during short-term water supply shortages caused by droughts or other emergencies. This phenomenon is known as "demand hardening." The California Urban Water Agencies defines demand hardening as, "the diminished ability or willingness of a customer to reduce demand during a supply shortage as the result of having implemented long-term conservation measures." Long term conservation measures can include hardware conservation measures, such as the installation of high efficiency toilets and behavioral conservation, such as watering during specified periods of the day.

Demand hardening occurs when options available for reducing water use are limited as the customer base is saturated with hardware conversions causing efficient water usage patterns to prevail. During "dry" years, utility customers who have actively participated in water conservation programs can be disproportionately impacted by water reductions as there is a limited ability for further conservation. The impact of demand hardening would be most prevalent during water supply shortages where customers have already been implementing long-term water conservation measures. Proponents of demand hardening believe that implementation and saturation of new hardware-based conservation devices would generally not occur rapidly enough during a water supply shortage, such as a drought, to reduce short-term water use.

However, it can be argued that hardware-based conservation devices will continue to be developed, piloted and implemented, such as the previously discussed weather based irrigation controllers, thus improving the ability to further conserve in the future. During droughts, consumers will respond to the call for more

conservation by behaviorally adjusting their water use through methods such as not leaving water running and taking shorter showers. Additionally, full saturation of current conservation devices has not occurred. For these reasons, others believe demand hardening is irrelevant and there is a continued need for aggressive conservation programs.

Full implementation of current conservation measures, including reducing leaks, has the potential to reduce per capita water demands even further. Past water conservation efforts have reduced water use within LADWP's service area even though the population has continued to expand as illustrated in Exhibit 3A. It is expected that future water conservation efforts will continue this trend as increased saturation of water saving hardware devices occurs and new hardware devices are developed.

Though not easily quantifiable, saturation of current water saving hardware devices and installation of future water saving hardware devices combined with potential demand hardening have the ability to impact demand forecasts. As a worst case scenario, demand hardening and its effects are considered in LADWP's water demand forecasts to ensure that the appropriate supply of water is planned for. However, LADWP will continue to maintain its aggressive water conservation program discussed within this section. In the future, LADWP's water demand forecasts will continue to be examined and adjusted accordingly to compensate for additional implementation of long-term water conservation measures as saturation increases and new technology results in new hardware devices.

### 3.3.3 Projected Water Conservation Savings

---

To assist in planning future water demands, meeting the Water Supply Action Plan goal, and complying with

### Exhibit 3I Active Conservation Projections by Sector

Sector	Acre-feet per Fiscal Year				
	2014/2015	2019/2020	2024/2025	2029/2030	2034/2035
Single-Family Residential	3,416	5,882	8,349	10,815	12,249
Multi-Family Residential	871	1,504	2,137	2,770	3,150
Commercial/Government	7,969	16,000	24,030	32,061	39,629
Industrial	1,924	3,847	5,824	7,774	9,339
Total Active Conservation Projections	14,180	27,260	40,340	53,420	64,368

20x2020 requirements, LADWP has taken numerous steps to project future water conservation savings by major customer classification for indoor and outdoor use.

Indoor and outdoor active conservation through 2035 has been estimated by major billing sectors as provided in Exhibit 3I. Values presented are cumulative year to year. The bulk of conservation is expected to occur in the indoor portion of the commercial/government sector followed by the industrial sector. Past conservation programs have heavily focused on residential conservation reflecting the smaller residential conservation projections. Residential conservation initially provided the greatest volume saved for the cost. Water use in the CII sector is varied and relatively more expensive to achieve than in the residential sector.

To determine potential conservation savings for indoor water use in the CII sector, LADWP conducted a high-level study to first estimate CII water use for each subsector (e.g. hospitals, refineries, schools, business parks, restaurants, etc.) and indoor end-use (e.g., toilets, showers, kitchen, laundry, food processing, cooling/heating, etc.), and second determine the potential for indoor water savings for each subsector and end-use. This study involved a sample of water use for approximately 150 of LADWP's largest CII customers to estimate total sector water use, along with employment data from Dunn & Bradstreet. Additional data sources listed below were used to determine indoor end-use estimates for each subsector, as well as the potential for water savings.

- *BMP 9: A Handbook for Implementing Commercial Industrial & Institutional Conservation Programs. (2001). California Urban Water Conservation Council.*
- *Commercial and Institutional End Uses of Water. (2000). American Water Works Association Research Foundation.*
- *Waste Not, Want Not: The Potential for Urban Water Conservation in California. (2003). Pacific Institute.*
- *Water Efficiency in the Commercial and Institutional Sector: Considerations for a WaterSense Program. (2009). U.S. Environmental Protection Agency.*
- *Watersmart Guidebook---A Water-Use Efficiency Plan-Review Guide for New Businesses. (2008). East Bay Municipal Utility District.*
- *Santa Clara Valley Water District Commercial Institutional Industrial Water Use & Conservation Baseline Study. (2008). CDM.*
- *Water and Energy Efficiency Program for Commercial, Industrial, and Institutional Customer Classes in Southern California. (2009). U.S. Bureau of Reclamation.*
- *Water Use Efficiency Comprehensive Evaluation. (2006). CALFED Bay-Delta Program.*

The study concluded that by targeting just the top 100 or so largest CII users, approximately 4,600 AFY of water could

be saved (representing about 3 percent of total CII water use). The study also found that the subsectors that use the most water in the City are: health care (18%), education (14%), food services/drinking places (9%), accommodation (5%), fabricated metal product manufacturing (5%), textile mills (5%), amusement (4%), and food manufacturing (4%). The study also concluded that the potential for indoor water conservation was approximately 23,000 AFY or 15 percent of total CII water use. Exhibit 3J presents the breakdown of this potential indoor water conservation for subsectors and end-uses.

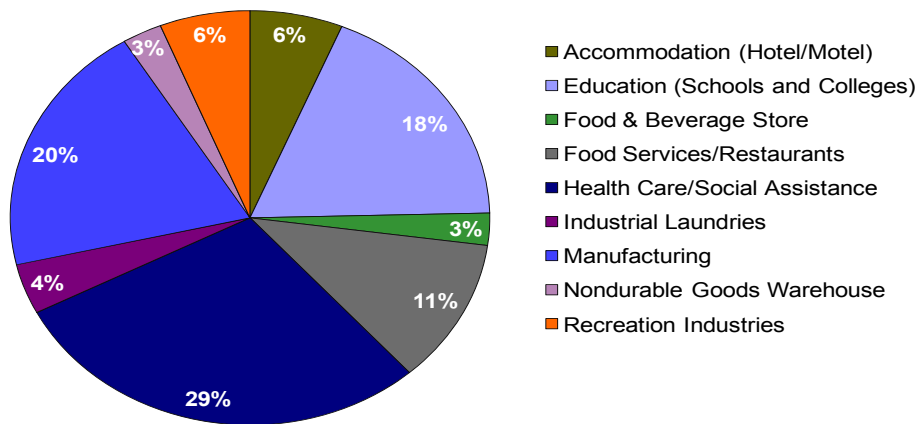
Outdoor water use as a percentage of total water use was approximated using

three methodologies to determine the potential for outdoor water conservation savings. The methodologies and percent outdoor water use determined for each methodology are:

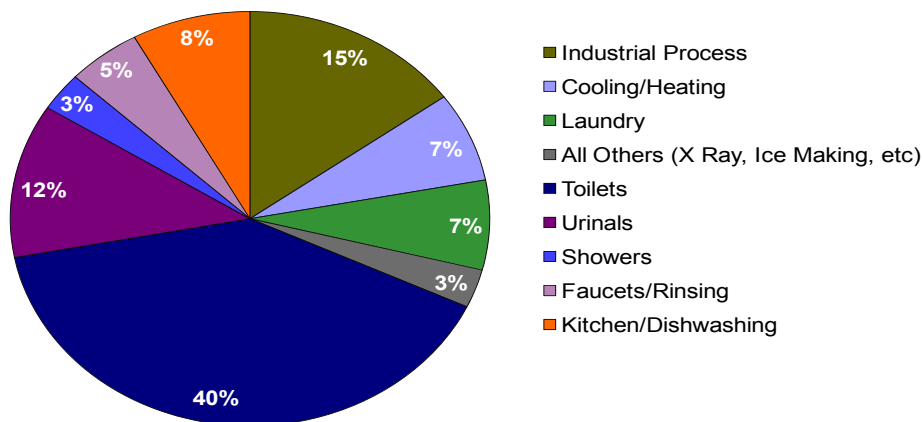
- Minimum-Maximum Methodology (outdoor water use is approximately 39.98 percent) – based on the premise that during wet months outdoor water use is minimal and during dry months outdoor water use is at its peak.
- Wastewater Treatment Plant Influent Methodology (outdoor water use is approximately 38.32 percent) – based on determining the average monthly influent flows to the City’s four wastewater treatment plants during

**Exhibit 3J**  
**Breakdown of Estimated CII Indoor Water Conservation Potential of 23,000 AF**

**Percent Water Saved per Subsector**



**Percent Water Saved per End-Use**





**Exhibit 3K**  
**Potential Outdoor Water Use Savings by Sector**

Customer Sector	Scenario 1	Scenario 2	Scenario 3
	(AFY)		
Single-Family Residential	13,246	42,464	100,901
Multi-family	5,956	19,095	45,371
Commercial	2,573	8,247	19,597
<b>Total</b>	<b>21,774</b>	<b>69,806</b>	<b>165,870</b>

the dry-weather months of June through September and adjusting for contract agency flows and dry-weather stormwater diversions.

- Infrared Analysis Methodology (outdoor water use is 39.67 percent) – based on an infrared analysis of the City to determine tree canopy and landscape coverages for use in estimating applicable water use requirements for greenscapes based on rainfall data, plant factors, evapotranspiration rates, and irrigation efficiencies.

The resultant range between the low and high outdoor water use percentage is approximately 1.35 percent. This narrow range resulting from the three methodologies confirms the methodologies are fairly accurate.

Greenscape areas related to commercial and residential land uses are the most likely areas to be targeted for outdoor water conservation. Rehabilitation of these areas to meet or exceed the evapotranspiration adjustment factor (ETAF) of 0.7 as required in the Model Water Efficient Landscape Ordinance would result in significant savings ranging

from 21,774 to 165,870 AFY. Currently, these savings are not represented in the projected active conservation in Exhibit 3I. Exhibit 3K illustrates the potential savings under three scenarios by customer sectors. Scenario 1 represents an improvement in average irrigation efficiencies and/or installation of less water intensive vegetation to achieve an ETAF of 0.7. Scenario 2 represents an improvement in average irrigation efficiencies and/or replacement of high water use vegetation with less water intensive vegetation in the moderate to low water use range to achieve an ETAF of 0.49. Scenario 3 represents an improvement in average irrigation system efficiency and replacement of all vegetation with very low water use vegetation almost entirely dependent upon effective precipitation to achieve an ETAF of 0.07. This would require incentive programs, such as cash for grass programs. Other large greenscape area, including parks, cemeteries and golf courses, were not considered in the analysis as they would more than likely be preserved as turf or tree canopy areas to retain quality of life benefits. These areas are likely to be targets for recycled water use.

### 3.4 Cost & Funding

The cost range of conservation rebates, incentives, and hardware installation programs ranges from approximately \$75/AF to \$900/AF based on current LADWP conservation programs. More than \$200 million has been invested in water conservation since 1991. Conservation is the cornerstone of LADWP's water demand management activities and ongoing investments will be made in viable programs, subject to funding availability and LADWP's ability to implement such programs. Outside sources of funding are sought to complement the City's resources. A stronger commitment is also being made to acquire outside grant funding for City conservation projects.

Currently, the funding sources for conservation are:

- Water Rates – Water conservation programs are primarily funded through water rates.
- MWD Conservation Credits Program - MWD offers both commercial and residential rebates to member agency customers that install specified conservation devices. The rebates equate to \$195 per AF of water saved, or half the project cost whichever is less. In addition, MWD reimburses the LADWP for pre-approved projects when completed. In 2009 MWD reimbursed the Department \$139,000 for a water broom distribution program. LADWP also expects to be reimbursed in 2011 through the MWD Member Agency Administered funding program for \$968,000. The monies are reimbursement for 22.2 acres of turf reduction projects through the Department's Commercial/Industrial Drought Resistant Landscape Incentive Program.
- Outside Agency Co-Funding - Other agencies realizing benefits from conservation programs are solicited for co-funding of program costs.

- Grant Funding - LADWP has successfully received grant funding from the State under Proposition 13. A grant for \$615,000 supplemented the rebate funding available for commercial ULF toilets and high efficiency clothes washers. LADWP expects to receive a final payment totaling \$128,299 for the Commercial High Efficiency Clothes Washer and Ultra Low Flow Toilet Consolidated Water Use Efficiency grant. LADWP has already received \$164,691 in support of 1,498 commercial high efficiency washer rebates. LADWP was awarded three grants in 2005 under Proposition 50, which are summarized below:

- The Cooling Tower Conductivity Controller Replacement Program: Grant to improve the water efficiency of 100 cooling towers in the city of Los Angeles. Total grant amount up to \$350,000. Expect completion in 2012.
- The Los Angeles City Park Irrigation Efficiency Program: Grant to improve the irrigation efficiency at 15 City of Los Angeles municipal parks by installing Weather Based Irrigation Controllers and by upgrading irrigation piping and rotors. Total grant amount up to \$362,000. Expect completion in 2011.
- The Large Landscape "Smart Irrigation" Program: Grant to replace existing manually-adjusted irrigation controllers with "smart irrigation" Weather Based Irrigation Controllers at 75 large landscape customer sites. Total grant amount \$131,000. Expect completion in 2011.



## Chapter Four Recycled Water

### 4.0 Overview

---

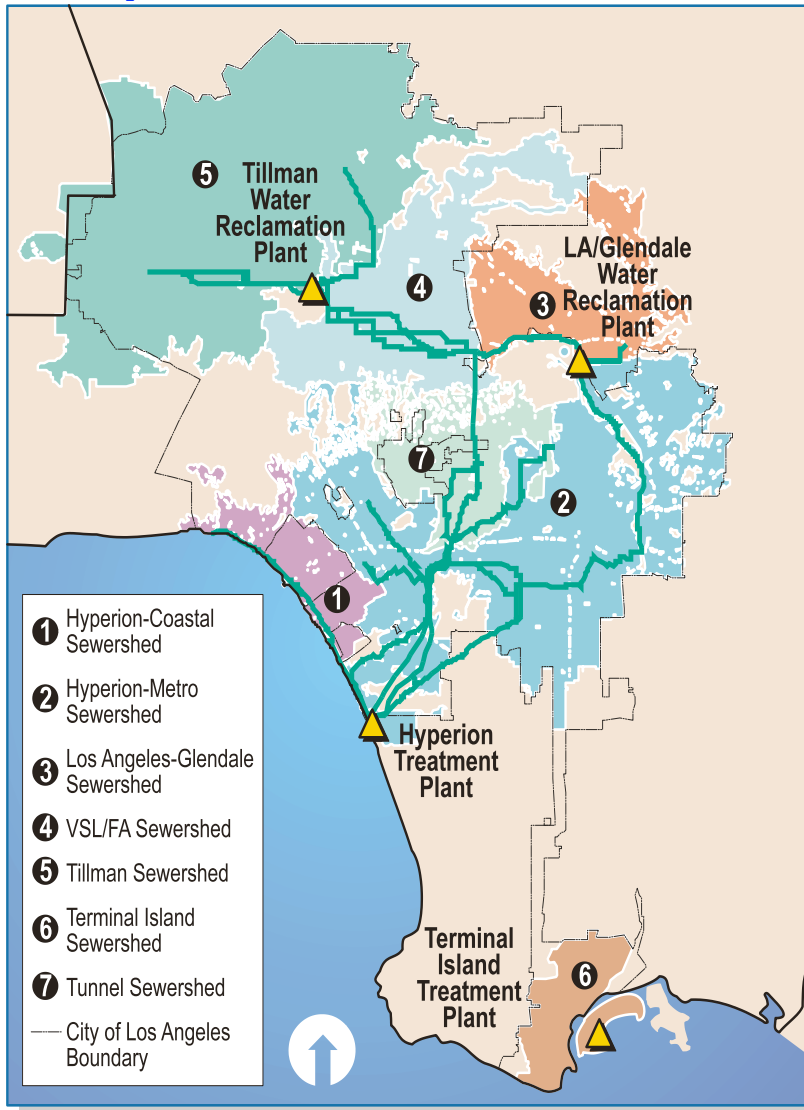
LADWP is committed to significant expansion of recycled water in the City's water supply portfolio. Recognizing the multiple factors that are decreasing the reliability of imported water supplies, LADWP released the City of Los Angeles Water Supply Action Plan (Plan), "Securing L.A.'s Water Supply" in May of 2008. The Plan established the goal of using 50,000 AFY of recycled water to offset demands on potable supplies. In order to meet this goal, LADWP, in conjunction with the Los Angeles Department of Public Works Bureau of Sanitation (BOS), are working together to develop a Recycled Water Master Plan (RWMP). Opportunities to expand the water recycling program are being studied through development of the RWMP. Opportunities include expanding the recycled water distribution system for Non-Potable Reuse (NPR) such as for irrigation and industrial use, and replenishment of groundwater basins with highly purified recycled water. Beyond 50,000 AFY, LADWP expects to increase recycled water use by approximately 1,500 AFY annually, bringing the total to 59,000 AFY by 2035.

LADWP's water recycling program is dependent on the City's wastewater treatment infrastructure. Wastewater in the City of Los Angeles is collected and transported through some 6,500 miles of

major interceptors and mainline sewers, more than 11,000 miles of house sewer connections, 46 pumping plants, and four treatment plants. BOS is responsible for the planning and operation of the wastewater program. The City's wastewater system serves 515 square miles, 420 square miles of which are within the City. Service is also provided to 29 non-City agencies through contract services. Exhibit 4A shows the City's four wastewater treatment plants and seven sewersheds that feed those plants. A portion of the treated effluent from these four wastewater plants is utilized by LADWP to meet recycled water demands.

As early as 1960, the City recognized the potential for water recycling and invested in infrastructure that processed water to tertiary quality, a high treatment standard for wastewater. This resulted in the building of tertiary wastewater treatment plants upstream instead of enlarging the two existing terminus treatment plants. These system enhancements brought about the City's expanded recycled water projects, which now supplement local and imported water supplies. The original policy allowing the use of recycled water was adopted by the State Legislature in 1969.

In 1979, LADWP began delivering recycled water to the Department of Recreation and Parks for irrigation of areas in Griffith Park. This service was later expanded to include Griffith Park's golf courses.



**Exhibit 4A  
City  
Wastewater  
Treatment  
Plants and  
Sewersheds**

In 1984, freeway landscaping adjacent to the park was also irrigated with recycled water. In addition, the Japanese Garden, Balboa Lake and Wildlife Lake in the Sepulveda Basin now utilize recycled water for environmentally beneficial reuse purposes. The Greenbelt Project, which carries recycled water from the Los Angeles-Glendale Water Reclamation Plant to Forest Lawn Memorial Park, Mount Sinai Memorial Park, Lakeside Golf Club of Hollywood and Universal Studios, began operating in 1992, and represents LADWP’s first project to supply recycled water to non-governmental customers. LADWP continues to successfully implement the use of recycled water for various purposes. In 2009, phase 1 of the Playa Vista development began receiving

recycled water. Playa Vista is the first planned development in the City that uses recycled water for all landscape needs. LADWP serves approximately 130 customers with recycled water for irrigation, industrial, and environmental beneficial uses. Future recycled water projects will continue to build on the success of these prior projects so that recycled water becomes a more prominent component of the City’s water supply portfolio.

The City’s water recycling projects seek to displace the use of potable water with recycled water for non-potable uses where infrastructure is available. In compliance with Chapters 7.0 and 7.5 of the California Water Code recycled water meets all of the following conditions:

- The source of recycled water is of adequate quality for these non-potable uses.
- The recycled water may be furnished for these uses at a reasonable cost to the user.
- The use of recycled water from the proposed source will not be detrimental to public health.
- The use of recycled water will not adversely affect downstream water rights or degrade water quality.

In addition, the California Water Code requires public agencies, such as the LADWP, to serve recycled water for non-potable uses if suitable recycled water is available.

LADWP is expanding irrigation and industrial/commercial uses of recycled water, and studying groundwater replenishment (GWR). Demand for recycled water is driven by customer acceptance of recycled water as a viable alternative to traditional potable supplies. Outreach efforts designed to educate the public on the viability of recycled water and its potential uses are an essential part of the process as the City’s recycled water program expands.



## 4.1 Regulatory Requirements

---

Recycled water use is governed by regulations at the State and local levels. These regulations are based on multiple factors including the type of use and water quality. LADWP currently provides recycled water for non-potable reuse and is pursuing indirect potable reuse through GWR using advanced treated recycled water. Requirements for these two categories of recycled water use are different. This section provides a summary of the complex recycled water regulations. A more in-depth description of these regulations will be included as part of the RWMP.

### 4.1.1 Non-Potable Reuse Regulations

---

Non-potable water reuse regulations in the City of Los Angeles are governed by the California Department of Public Health (CDPH), State Water Resources Control Board (SWRCB), Los Angeles Regional Water Quality Control Board (LARWQCB) and the Los Angeles County Department of Public Health (LACDPH).

#### California Department of Public Health

Criteria and guidelines for the production and use of recycled water were established by the CDPH in the California Code of Regulations, Title 22, Division 4, and Chapter 3 (Title 22). Title 22, also known as Water Recycling Criteria, establishes required wastewater treatment levels and recycled water quality levels dependent upon the end use of the recycled water. Title 22 additionally establishes recycled water reliability criteria to protect public health.

Title 22 specifies recycled water use restrictions based on the potential degree

of public exposure to the water and the distance of drinking water wells and edible crops from the area of intended use. Recycled water use applicability also depends on the different levels of treatment. A higher quality water will have a wider variety of applicable uses than a lower quality water. At a minimum, secondary treatment of wastewater is required for recycled water use. In the City of LA, however, all recycled water used is treated, at a minimum, to tertiary levels with additional disinfection. Wastewater treatment levels are discussed in detail in subsection 4.2 of this chapter. Title 22 allows for other treatment methods, subject to CDPH approval. The reliability of the treatment process and the quality of the product water must meet the Title 22 requirements specified for each allowable treatment level. Exhibit 4B provides a summary of the currently approved recycled water uses.

Areas where recycled water is used occur within defined boundaries. Title 22 stipulates use area requirements to protect public health. Use area regulations include requirements addressing recycled water application methods and runoff near domestic water supply wells, drinking fountains, and residential areas. Other requirements include posting signs notifying the public where recycled water is being used, utilization of quick couplers instead of hose bibs, and the prohibition against connecting recycled water systems with potable water systems. Dual-plumbed recycled water systems in buildings are also addressed. These systems must meet additional reporting and testing requirements.

To protect public health, Title 22 requires reliability mechanisms. During the design phase, a Title 22 Engineering Report is required to be submitted to CDPH and the local Regional Water Quality Control Board (RWQCB) for approval. Contents of the report include a description of the system and an explanation regarding how the system will comply with Title 22 requirements. Redundancy in treatment

**Exhibit 4B  
Allowable  
Title 22  
Recycled  
Water Uses**

<b>Irrigation Uses</b>
Food crops where recycled water contacts the edible portion of the crop, including all root crops
Parks and playgrounds
School yards
Residential landscaping
Unrestricted access golf courses
Any other irrigation uses not prohibited by other provisions of the California Code of Regulations
Food crops, surface irrigated, above ground edible portion, and not contacted by recycled water
Cemeteries
Freeway landscaping
Restricted access golf course
Ornamental nursery stock and sod farms with unrestricted public access
Pasture for milk animals for human consumption
Non edible vegetation with access control to prevent use as park, playground or school yard
Orchards with no contact between edible portion and recycled water
Vineyards with no contact between edible portion and recycled water
Non food bearing trees, including Christmas trees not irrigated less than 14 days before harvest
Fodder and fiber crops and pasture for animals not producing milk for human consumption
Seed crops not eaten by humans
Food crops undergoing commercial pathogen destroying processing before consumption by humans
Supply for impoundment
Non restricted recreational impoundments, with supplemental monitoring for pathogenic organisms
Restricted recreational impoundments and publicly accessible fish hatcheries
<b>Supply for Impoundment Uses</b>
Non restricted recreational impoundments, with supplemental monitoring for pathogenic organisms
Restricted recreational impoundments and publicly accessible fish hatcheries
Landscape impoundments without decorative fountains
<b>Supply for cooling or air conditioning</b>
Industrial or commercial cooling or air conditioning involving cooling tower, evaporative condenser, or spraying that creates a mist
Industrial or commercial cooling or air conditioning not involving cooling tower, evaporative condenser, or spraying that creates a mist
<b>Other Uses</b>
Dual plumbing systems (flushing toilets and urinals)
Priming drain traps
Industrial process water that may contact workers
Structural fire fighting
Decorative fountains
Commercial laundries
Consolidation of backfill material around potable water pipelines
Artificial snow making for commercial outdoor uses
Commercial car washes, not heating the water, excluding the general public from washing process
Industrial process water that will not come into contact with workers
Industrial boiler feed
Nonstructural fire fighting
Backfill consolidation around non potable piping
Soil compaction
Mixing concrete
Dust control on road and streets
Cleaning roads, sidewalks and outdoor work areas
Flushing sanitary sewer
Groundwater replenishment



units or other means to treat, store, or dispose of recycled water are required in case the treatment unit is not operating within specified parameters. Alarms for operators are required to indicate treatment plant process failures or power failures. In case of power failures, either back-up power, automatically activated short-term or long-term recycled water storage, or a means of disposal is required. Furthermore, system performance must be monitored by water quality sampling and analyses.

As mentioned previously, cross-connections between the potable and recycled water systems are not permitted. The California Code of Regulations, Title 17, Division 1, Chapter 5, Group 4 prevents cross-connections between potable water supply systems and recycled water supply systems. Title 17 specifies that water suppliers must implement cross-connection control programs and backflow prevention systems.

In addition to Title 22 and Title 17 requirements, CDPH has additional regulations and guidance established in the following documents:

- Guidelines for the Preparation of an Engineering Report for the Production, Distribution, and Use of Recycled Water (2001)
- Guidance Memo No. 2003-02: Guidance for the Separation of Water Mains and Non-Potable Pipelines (2003)
- Treatment Technology Report for Recycled Water (2007)

### **State Water Resources Control Board and Los Angeles Regional Water Quality Control Board**

In May 2009, the SWRCB adopted “Recycled Water Policy” developing uniform standards across all Regional Water Quality Control Boards for interpreting the “Anti-Degradation Policy”. When planning and implementing recycled water projects the following must be taken into consideration:

- Mandate for recycled water use – encourages recycled water use and establishes targets to increase use.
- Salt/nutrient management plans –

requires submittal of salt/nutrient management plans by 2014.

- Landscape irrigation projects' control of incidental runoff and streamlined permitting – addresses controlling incidental runoff and streamlining permit processes for recycled water use in landscape areas.
- Groundwater replenishment – establishes requirements for groundwater replenishment projects.
- Anti-degradation – establishes that salt and nutrient management plans can address groundwater quality impacts.
- Chemicals of emerging concern – establishes a blue-ribbon advisory panel to develop a report on chemicals of emerging concern and update the report every five years.

Water recycling requirements for each of the City's applicable wastewater treatment plants engaged in water recycling are issued by the LARWQCB. These requirements specify end-users of recycled water and enforce treatment and use area requirements.

In July 2009, the SWRCB adopted a general landscape irrigation permit, "General Waste Discharge Requirements for Landscape Irrigation Uses of Municipal Recycled Water" (General Permit). The General Permit streamlines the regulatory approval for landscape irrigation using recycled water. Agencies with existing water recycling requirements, such as the City, are not required to apply for the General Landscape Irrigation Permit.

Earlier in April 2009, the LARWQCB adopted a general region-wide permit, "General Waste Discharge and Water Recycling Requirements for Non-Irrigation Uses over the Groundwater Basins Underlying the Coastal Watersheds of Los Angeles and Ventura Counties" for non-irrigation uses of recycled water. Similar to the General Permit, this permit streamlines the

permitting process and specifies the application process for qualifying projects.

## **Los Angeles County Department of Public Health**

Title 22 and Title 17 water use regulations are enforced by the LACDPH, Environmental Health Division. LACDPH has published "A Guide to Safe Recycled Water Use, Pipeline Construction and Installation" requiring compliance with Title 22, CDPH, and LARWQCB requirements. After CDPH has approved the plans and specifications and the City has an agreement to serve the customer, LACDPH reviews and approves all plans and specifications prior to construction. After construction LACDPH inspects the systems and conducts cross-connection, pressure, and back-flow prevention device tests. Recycled water use must occur in compliance with the Los Angeles County Recycled Water Advisory Committee's "Recycled Water Urban Irrigation User's Manual". Each site must also have a site supervisor responsible for recycled water use.

## **City of Los Angeles**

Recycled water responsibilities of the City of Los Angeles include complying with all LARWQCB permits for the wastewater treatment plants and production of recycled water, approving recycled water use sites, conducting post-construction inspections, and periodically inspecting use areas and site supervisor records.

LADWP customers are permitted to use recycled water when service is available per LADWP Ordinance No. 170435 (subsequently amended by Ordinance No. 178902 in 2008). Users are responsible for the operation and maintenance of their recycled water systems up to the connection point with LADWP. Users are required to use recycled water in accordance with Titles 22 and 17 and the "Recycled Water Urban Irrigation User's Manual."

## 4.1.2 Groundwater Replenishment Regulatory Requirements

The regulations governing recharge of groundwater or groundwater replenishment (GWR) with recycled water are established by the CDPH and LARWQCB. The City's GWR project as described in section 4.4.3 will be subject to these regulations.

For GWR, LADWP will implement advanced treatment that includes reverse osmosis, microfiltration, and advanced oxidation. This level of treatment addresses water quality concerns for the health of the basin along with emerging contaminants of concern.

### California Department of Public Health

Regulatory oversight of GWR projects is provided by the CDPH. CDPH regulates GWR projects under Title 22, making recommendations on a case-by-case basis after a public hearing. Requirements for replenishment are not provided in Title 22. Draft GWR Reuse Criteria, released in August 2008, are used by the CDPH to evaluate projects for approval or denial. The draft regulations are designed to protect public health by:

- Requiring recycled water to meet maximum contaminant levels (MCLs) established for drinking water.
- Establishing the volume of recycled water used based on Total Organic Carbon (TOC), dilution, and treatment levels.
- Requiring recycled water to be retained in a groundwater basin for six months before reaching a well used for drinking water with validation by a tracer study.
- Requiring quarterly monitoring for specified pollutants and chemicals and yearly monitoring of constituents



indicating the presence of wastewater in produced recycled water and in downgradient monitoring wells.

- Implementing a source control program.
- Establishing additional requirements for projects with recycled water contributions greater than 50 percent, including a review by an Independent Advisory Panel.

As also required for non-potable reuse, project proponents must submit a Title 22 Engineering Report to the CDPH and LARWQCB for review. After completion of the report, the CDPH holds a public hearing followed by issuance of Findings of Fact and Conditions for submission to the LARWQCB.

## Los Angeles Regional Water Quality Control Board

Prior to the issuance of a permit, the LARWQCB reviews CDPH's Findings of Fact and Conditions and considers provisions in the adopted Los Angeles Basin Plan (Basin Plan) for the LARWQCB region, applicable State policies (including the SWRCB Recycled Water Policy), and applicable federal regulations if recycled water is discharged to "Waters of the U.S." The Basin Plan establishes water quality objectives for surface water and groundwater to protect beneficial uses. The LARWQCB then holds a public hearing to consider the permit. Ultimately, if approved, permits are issued by the LARWQCB in the form of water reclamation requirements and waste discharge requirements.

### 4.2 Wastewater Treatment Plants

There are four wastewater treatment plants owned and operated by the BOS. City wastewater treatment consists of a series of processes that, at a minimum, remove solids to a level sufficient to meet regulatory water quality standards. During the preliminary, primary,

secondary, and tertiary treatment processes, progressively finer solid particles are removed. Preliminary treatment removes grit and large particles through grit removal basins and screening. Primary treatment relies on sedimentation to remove smaller solids. With most of the grit, large particles, and solids already removed, secondary treatment converts organic matter into harmless by-products and removes more solids through biological treatment and further sedimentation. At the end of secondary treatment, most solids will have been removed from the water. Tertiary treatment follows secondary treatment to eliminate the remaining impurities through filtration and chemical disinfection. At this stage, sodium hypochlorite (the chemical contained in household bleach) provides disinfection. All recycled water used within the City undergoes, at a minimum, tertiary treatment and disinfection. In the Harbor Area, recycled water also undergoes advanced treatment with microfiltration/reverse osmosis (MF/RO) and is injected into the Dominguez Gap Barrier to protect against seawater intrusion. MF/RO is a two-stage process using high-pressure membrane filters to remove microscopic impurities from the source water. Exhibit 4C summarizes the treatment levels, capacity, and average flows at the four plants.

**Exhibit 4C Wastewater Treatment Plants Summary**

Wastewater Treatment Plants	Treatment Level	Capacity (mgd)	Average Flows (mgd) <sup>1</sup>
Donald C. Tillman Water Reclamation Plant (DCT)	Tertiary to Title 22 standards with Nitrification/Denitrification	80	32
Los Angeles - Glendale Water Reclamation Plant (LAG)	Tertiary to Title 22 standards with Nitrification/Denitrification	20	17
Terminal Island Water Reclamation Plant (TIWRP)	Tertiary; Advanced treatment (MF/RO) of 5 mgd	30	16
Hyperion Treatment Plant (HTP)	Full secondary <sup>2</sup>	450	299

1. Average FY 2009/10 flows. Approximately 13 mgd is currently diverted from DCT to HTP.

2. 34 mgd of full secondary treated water delivered to West Basin Water Reclamation Plant operated by West Basin Municipal Water District. Water treated to Title 22 standards for recycled water use.

Source: City of Los Angeles, Bureau of Sanitation, Draft Recycled Water Use FY 2009/10.

### **4.2.1 Donald C. Tillman Water Reclamation Plant**

---

In service since 1985, the Donald C. Tillman Water Reclamation Plant (DCT) has an average dry-weather flow capacity of 80 million gallons per day (mgd) and currently treats about 32 mgd. During wet weather, treatment is limited to 40 mgd to prevent downstream infiltration surcharges on the sewer system while utilizing the remaining capacity for limited wet weather storage. Currently, the Los Angeles Department of Public Works – Bureau of Engineering (BOE) is designing wet-weather storage basins to allow year round operation at 80 mgd. The current level of treatment is Title 22 (tertiary) with nitrogen removal (nitrification/denitrification (NdN)). DCT provides recycled water for the Japanese Garden, Wildlife Lake, Lake Balboa, treatment plant reuse, and irrigation and industrial uses. Irrigation uses in the adjacent areas include golf courses, parks, and a sports complex. Industrial uses include the Valley Generating Station. The remaining tertiary-treated water is discharged into the Los Angeles River. A GWR project is being planned that will purify DCT effluent, utilizing advanced treatment to recharge the San Fernando Groundwater Basin. The project will initially recharge 15,000 AFY with the eventual goal of achieving 30,000 AFY.

### **4.2.2 Los Angeles-Glendale Water Reclamation Plant**

---

The Los Angeles-Glendale Water Reclamation Plant (LAG) is a joint project of the City of Los Angeles and City of Glendale. LAG began treating wastewater in 1976. Its average dry-weather flow design capacity is 20 mgd and it currently treats about 17 mgd. Each city is entitled to 50 percent of the plant's capacity. The City of Pasadena

purchased rights to 60 percent of Glendale's capacity but has not yet exercised these rights. The current level of treatment is Title 22 (tertiary) with nitrogen removal (NdN). Recycled water from the LAG provides landscape irrigation to Griffith Park and the Los Angeles Greenbelt Project, including Forest Lawn Memorial Park, Mount Sinai Memorial Park, Universal Studios, and the Lakeside Golf Course. The City of Glendale retains the right to half of the recycled water produced at the plant and serves a number of customers in their service area. As with the DCT, the remaining tertiary-treated water from LAG is discharged into the Los Angeles River.

### **4.2.3 Terminal Island Water Reclamation Plant**

---

Originally built in 1935, the Terminal Island Water Reclamation Plant (TIWRP) has been providing secondary treatment since the 1970s. Tertiary treatment systems were added in 1996. TIWRP has a current average dry-weather flow capacity of 30 mgd and treats about 16 mgd. The recently completed Advanced Wastewater Treatment Facility adds MF/RO treatment to a portion of the wastewater effluent to produce approximately 3.0 mgd of recycled water. Recycled water is supplied to the Dominguez Gap Seawater Intrusion Barrier to reduce seawater intrusion into drinking water aquifers, and to LADWP's Harbor Generating Station for landscape irrigation. The remaining TIWRP effluent is discharged to the Los Angeles Harbor. Future recycled water production is expected to increase to more fully supply the Dominguez Gap Seawater Intrusion Barrier along with other potential customers in the Harbor Area.

### 4.2.4 Hyperion Treatment Plant

Operating since 1894, the Hyperion Treatment Plant (HTP) is the oldest and largest of the City’s wastewater treatment plants. Its \$1.2 billion construction upgrade, completed in 1999, allows for full secondary treatment. The current average dry-weather flow capacity of HTP is 450 mgd, with an average wastewater flow of 299 mgd. A majority of the treated water is discharged through a 5-mile outfall into the Santa Monica Bay, and the rest, approximately 31 mgd, is delivered to the West Basin Water Reclamation Plant to meet recycled demands in the West Basin Municipal Water District (WBMWD) service area and parts of the City of Los Angeles. As of 2008, approximately 37,000 AFY of water from HTP Plant is sold to WBMWD for additional treatment. A portion of this water is bought back by LADWP to serve to customers in West Los Angeles, and the rest is then used to meet

recycled water demands in WBMWD’s service area. Customers in West Los Angeles include Loyola Marymount University and Playa Vista.

### 4.2.5 Projected Wastewater Volume

Average dry-weather wastewater influent projections for the City’s wastewater treatment plants are expected to increase by approximately 20 percent over the next 25 years. Projections include flows from 29 agencies outside of the City with contracts for wastewater treatment. Wastewater effluent that is not recycled is discharged to either the Pacific Ocean via the Los Angeles River, or to outfalls leading directly to the Pacific Ocean. Wastewater treatment projections of average dry-weather flows through 2035, and associated disposal methods, are provided in Exhibit 4D.

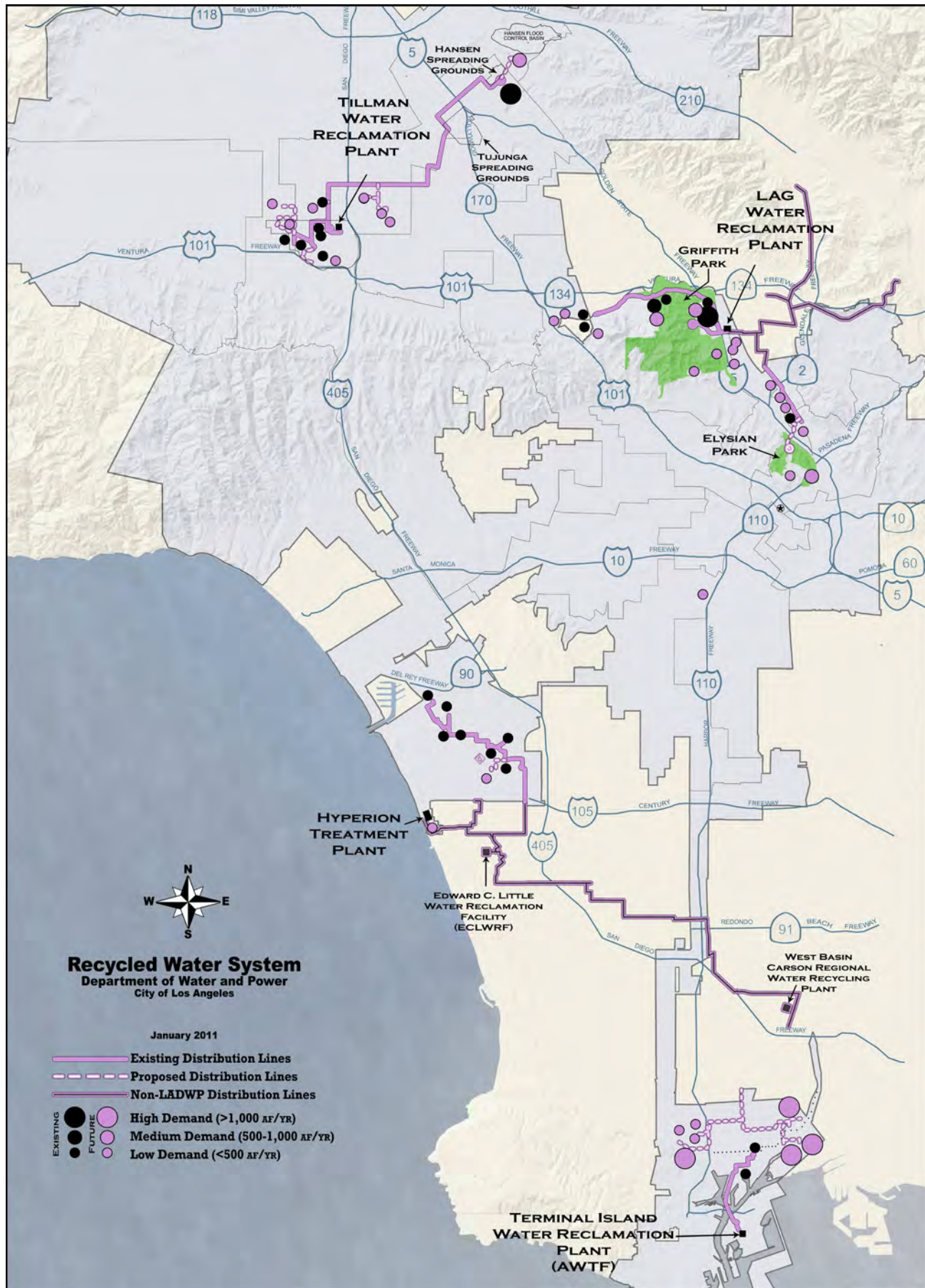
**Exhibit 4D Wastewater Treatment Plant Average Dry-Weather Flows, Reuse and Discharge Method**

Wastewater Treatment Plants	Reuse and Discharge Method	Average Dry-Weather Flow Projections (AFY)					
		Actual 2010	2015	2020	2025	2030	2035
Donald C. Tillman Water Reclamation Plant	Recycling and Pacific Ocean via Los Angeles River	36,000	84,000	86,000	88,000	90,000	93,000
Los Angeles - Glendale Water Reclamation Plant	Recycling and Ocean via Los Angeles River	19,000	25,000	27,000	29,000	32,000	34,000
Terminal Island Water Reclamation Plant	Recycling and Outfall to Ocean	18,000	19,000	19,000	19,000	20,000	20,000
Hyperion Treatment Plant	Conveyance to WBMWD for Recycling and Ocean outfall	335,000	340,000	346,000	352,000	366,000	381,000
Total		408,000	468,000	478,000	488,000	508,000	528,000

Source: City of Los Angeles, Bureau of Sanitation, Draft Recycled Water Use FY 2009/10. 2015 – 2035 projections from Sanitation’s “Project Flow Summary\_consultants” file. Data is generated from “Mike Urban” sewer flow projection model, and represents sewershed flows.



**Exhibit 4E  
Recycled Water System**



### 4.3 Existing Recycled Water Deliveries

The City has several recycled water projects currently providing recycled water for landscape irrigation, industrial, and commercial uses spread throughout four service areas:

- Harbor – located in the southern portion of the City and currently served by TIWRP.
- Central City (Metro) – located in the central/eastern portion of the City and served by LAG.
- San Fernando Valley – located in the northern portion of the City and served by DCT.
- Westside – located in the central/western portion of the City and served by HTP through the WBMWD Edward C. Little Water Recycling Facility (ECLWRF).

Locations of the service areas are depicted in Exhibit 4E. Recycled water service areas

coincide with potable water service areas. Recycled water deliveries for 2009 were 38,000 AFY, inclusive of municipal and industrial, environmental, and in-plant reuse. Estimated annual average demands for online projects were 39,000 AFY.

#### 4.3.1 Harbor Area

Recycled water in the Los Angeles Harbor Area is currently produced at the Advanced Water Treatment Facility (AWTF) located at the TIWRP. The AWTF began operating in 2002 with first deliveries to the Dominguez Gap Seawater Barrier in 2006. This project was developed jointly by LADWP, the Bureau of Sanitation (BOS), and BOE. Operation and maintenance is provided by BOS with funding from LADWP. Recycled water, treated using microfiltration and reverse osmosis, is currently used for landscape irrigation and groundwater injection with current demands of approximately 3,050 AFY. Treatment capacity of the AWTF is approximately 5,600 AFY. Excess recycled water is

#### Exhibit 4F Harbor Recycling

Program	Existing Annual Demand (AFY)
Irrigation	
Harbor Generating Station	50
Seawater Barrier	
Dominguez Gap Barrier (Water Replenishment District)	3,000
<b>Total Harbor Water Recycling Project</b>	<b>3,050</b>

Source: City of Los Angeles Recycled Water Master Plan Technical Memorandum, Draft Existing and Tier 1 Recycled Water Systems TM, December 14, 2009 and LADWP Water Recycling Staff

discharged into the Los Angeles Harbor. Exhibit 4F summarizes typical annual demands in the Harbor Area. Currently two customers are served: LADWP's Harbor Generating Station and the Water Replenishment District (WRD).

### Water Replenishment District

The WRD's recycled water demands are approximately 3,000 AFY for groundwater injection for the Dominguez Gap Seawater Intrusion Barrier. 50 percent recycled water and 50 percent imported water is injected into the barrier to protect the West Coast Groundwater Basin from seawater intrusion.

LADWP is currently expanding recycled water infrastructure in the Harbor Area to serve large industrial and additional irrigation customers. This will increase recycled water usage by at least 9,300 AFY by FY 2014/15.

## 4.3.2 Metro Area

The Metro Recycled Water System has supplied the Metro Service Area with recycled water produced at LAG to irrigation customers since 1979. LAG provides recycled water treated to a tertiary level meeting Title 22 standards with nitrogen removal. As previously stated, recycled water produced at LAG is equally split between the cities of Los Angeles and Glendale. Current recycled

water demands for the Metro Service Area are 1,930 AFY. Unused recycled water is discharged to the Los Angeles River. Exhibit 4G summarizes current demands for Metro Recycled Water System. Currently, eleven customers are served by the Metro Recycled Water System.

### Griffith Park Project

Started in 1979, the Griffith Park project was the City's first recycled water project. Recycled water is used to irrigate two golf courses, parkland, and the Los Angeles Zoo parking lot. Current demands in the Griffith Park Project's service area are 1,120 AFY.

### Greenbelt Project

Dedicated in 1992, the Los Angeles Greenbelt Project was the City's first commercial recycling project. Recycled water is used for landscape irrigation at Forest Lawn Memorial Park-Hollywood Hills, Mount Sinai Memorial Park, Lakeside Golf Course and Universal Studios. Current demands in the Greenbelt Project's service area are 720 AFY.

### Taylor Yard Project

Rio de Los Angeles State Park was connected as the first Taylor Yard project in July 2009. Recycled water is used for landscape irrigation on the park. Current demands in the Taylor Yard Project's service area are 90 AFY.

### Exhibit 4G Metro Recycling

Program	Existing Annual Demand (AFY)
Irrigation	
Greenbelt Project	1120
Griffith Park	720
Taylor Yard Project	90
<b>Total Irrigation</b>	<b>1,930</b>

Source: City of Los Angeles Recycled Water Master Plan Technical Memorandum, Draft Existing and Tier 1 Recycled Water Systems TM, December 14, 2009 and LADWP Water Recycling Staff

## Exhibit 4H Valley Recycling

Program	Existing Annual Demand (AFY)
Irrigation	
Sepulveda Basin Project	1570
Van Nuys Area Project	14
<b>Subtotal Irrigation</b>	1,584
Industrial	
Hansen Area Project	
Valley Generating Station	2,100
DCT Reuse <sup>1</sup>	2,920
<b>Subtotal Industrial</b>	5,020
Environmental Use <sup>2</sup>	
Japanese Garden	4,590
Wildlife Lake	7,700
Balboa Lake	14,700
<b>Subtotal Environmental Use</b>	26,990
<b>Total Valley Recycled Water System</b>	<b>33,594</b>

1. Based on 2006-2008 actual use.

2. Does not include environmental benefits provided to Los Angeles River.

Source: City of Los Angeles Recycled Water Master Plan Technical Memorandum, Draft Existing and Tier 1 Recycled Water Systems TM, December 14, 2009 and LADWP Water Recycling Staff

### 4.3.3 San Fernando Valley Area

The Valley Recycled Water System receives water from DCT to satisfy irrigation, environmental, and industrial demands. Recycled water is treated to a tertiary level meeting Title 22 standards with nitrogen removal. Current estimated recycled water demands for the San Fernando Valley Area are 33,594 AFY. Recycled water produced in excess of demand is discharged to the Los Angeles River providing added environmental benefits. Exhibit 4H summarizes current demands for the Valley Recycled Water System. The East Valley trunkline, a 54-inch-diameter pipeline, was previously constructed as the initial backbone of the Valley Recycled Water System's distribution system to deliver water throughout the San Fernando Valley for irrigation, commercial, and industrial use. Eleven customers are currently served by the Valley Recycled Water System, excluding DCT reuse and environmental use.

#### Sepulveda Basin Project

LADWP began serving recycled water to portions of the Sepulveda Basin area in 2007. The latest project was added in 2010. Current recycled water customers in the Sepulveda Basin recreation area include Woodley Golf Course, Balboa Golf Course, Encino Golf Course, Anthony C. Beilenson Park, Van Nuys Golf Course and the Balboa Sports Complex. Current demands in the recreation area are 1,570 AFY.

#### Van Nuys Area Project

The Van Nuys Area project currently provides recycled water for irrigation purposes to St. Elisabeth's Church, the First Foursquare Church of Van Nuys, Van Nuys High School, and LADWP's Power Distribution Station 81. Current Van Nuys Area Project demands are 14 AFY.

#### Hansen Area Project

The Hansen Area project currently provides recycled water for industrial purposes to LADWP's Valley Generating

Station. Recycled water service began in 2008 and demands are approximately 2,100 AFY. Recycled water is used in a cooling tower for one of the generation units at the power generating facility.

### Donald C. Tillman Water Reclamation Plant Reuse

Recycled water is used at DCT for in-plant purposes. Demands vary from year to year based on needs. Between 2006 and 2008 an average of 2,920 AFY was used.

### Environmental Use

Recycled water from DCT has provided environmental benefits since 1984, commencing with deliveries to the Japanese Garden and followed by deliveries to Balboa Lake in 1990 and Wildlife Lake in 1991. Approximate demands are 26,990 AFY. Overflows from these facilities are discharged to the Los Angeles River to provide additional environmental benefits in conjunction with unused recycled water discharges to the river.

### Japanese Garden

The 6.5-acre Japanese Garden is located at the Sepulveda Dam Recreation Area. The Garden receives more than 10,000 visitors per year. DCT provides about 4,590 AFY of recycled water for the lake and landscaping at the Japanese Garden.

### Wildlife Lake

Located in the Sepulveda Basin, the Wildlife Lake uses about 7,700 AFY of recycled water from DCT for wildlife habitat management.

### Lake Balboa

Lake Balboa is the centerpiece of the Sepulveda Dam Recreation Area and is a popular recreational facility located in Anthony C. Beilenson Park. About 14,700 AF per year of recycled water is provided for this lake from DCT.

## 4.3.4 Westside Area

Recycled water supplied to the Westside Recycled Water System is provided by WBMWD via the Edward C. Little Water Recycling Facility (ECLWRF), located in the City of El Segundo, for irrigation and commercial (toilet flushing) demands. The ECLWRF further treats up to 40 mgd of secondary-treated effluent received from HTP to a tertiary level meeting Title 22 standards. Under an agreement between WBMWD and the City, WBMWD purchases secondary-treated effluent from HTP, and LADWP has a right to purchase up to 25,000 AFY of recycled water from the ECLWRF. Approximately 37,300 AF of secondary-treated effluent was purchased from HTP in 2008, and LADWP purchased 380 AF of recycled water to serve West Los Angeles. Recycled water not purchased by LADWP is sold to users within WBMWD's service area.

Deliveries of recycled water from the Westside Recycled Water System first began in 1996. To increase the use of recycled water in West Los Angeles, LADWP has constructed

### Exhibit 4I Westside Recycled Water System Existing Annual Demand

Program	Existing Annual Demand (AFY)
Playa Vista Phase 1 (95 customers)	205
Coldwell Banker	2
Cal Trans at Playa Vista	5
Los Angeles International Airport	158
Westchester Golf Course	62
Loyola Marymount University	64
Westchester Park	43
Scattergood Generating Station	31
Carl Nelson Youth Park	16
The Parking Spot	1
Street Medians	4
Hyperion Treatment Plant <sup>1</sup>	85
<b>Total Westside Recycled Water System</b>	<b>676</b>

Source: City of Los Angeles Recycled Water Master Plan Technical Memorandum, Draft Existing and Tier 1 Recycled Water Systems TM, December 14, 2009 and LADWP Water Recycling Staff

more than five miles of distribution trunk lines to serve the Westchester, Los Angeles International Airport, and Playa Vista development areas. Current estimated recycled water demands in West Los Angeles are 676 AFY as shown in Exhibit 4I. Currently, 106 customers are served by the system.

### **Playa Vista**

Playa Vista is the first planned development in the City to use recycled water for the irrigation of all of its landscaping and for residential outdoor use. This project began receiving recycled water in 2009. Recycled water is required for outdoor use under the development's mitigation requirements established during the environmental review process. Recycled water is additionally used for toilet flushing in commercial buildings. Annual demands are approximately 200 AFY.

### **Los Angeles International Airport**

Los Angeles International Airport began using recycled water in 1996 for landscape irrigation purposes along its boundaries. Current demands for the airport are 158 AFY.

### **Loyola Marymount University**

Loyola Marymount University has been connected to the Westside system since 1996. Recycled water is used for landscape irrigation on a portion of the campus. Average annual demands are approximately 65 AFY.

### **Westchester Golf Course**

Westchester Golf Course began using recycled water in 2009 for irrigation. Current demands for the golf course are 62 AFY.

### **Westchester Park and Carl Nelsen Youth Park**

Westchester and Carl Nielsen Youth Parks both use recycled water for landscape irrigation. Both parks were connected

to the system in 1996. Westchester Park demands are approximately 43 AFY and Carl Nielsen Youth Park demands are 16 AFY.

### **Scattergood Generating Station**

Scattergood Generating Station operated by LADWP and located in El Segundo receives recycled water to meet irrigation demands. Average annual demand is approximately 31 AFY. The pipeline servicing the facility is oversized to potentially provide cooling water in the future.

### **Street Medians and The Parking Spot**

Street medians on Manchester Avenue and The Parking Spot were connected to the recycled water system in 2008 and 2003, respectively. Recycled water is served to both facilities to meet irrigation demands. The Parking Spot is a commercially operated parking facility near Los Angeles International Airport. Demands for The Parking Spot are approximately 1 AFY and demands for the street medians are approximately 5 AFY.

### **Hyperion Treatment Plant**

HTP uses recycled water for both landscape irrigation and toilet flushing within the administration building. HTP was connected to the system in 1996. About 65 AF of recycled water are provided to HTP per year.

## **4.3.5 Comparison of 2010 Projections Versus Actual Use**

LADWP has made progress in increasing recycled water use in the interim period between completion of the 2005 and 2010 UWMPs. Municipal and industrial recycled water use between 2005 and 2010 increased from 1,500 AFY to 6,703 AFY. The 2005 UWMP projected municipal and industrial recycled water

**Exhibit 4J**  
**2005 UWMP Recycled Water Projections for 2010 versus Actual Use**

Program	2005 Projection for 2010 (AFY)	09/10 Actual Use (AFY)
Municipal & Industrial Purposes <sup>1</sup>	16,950	6,703
Environmental Use <sup>2</sup>	26,990	25,008
<b>Total</b>	<b>43,940</b>	<b>31,711</b>

1. These recycled water supplies offset the demand for imported water within LADWP’s service area, but do not include DCT reuse of 2,920 AFY and deliveries to WBMWD of 34,000 AFY.

2. Typical environmental use is 26,990 AFY, but was not included in 2005 UWMP projection. Water is ultimately discharged into the Los Angeles River, providing additional environmental benefit. 2005 UWMP projections for 2010 are based on average demands.

Sources: City of Los Angeles Recycled Water Master Plan Technical Memorandum, Draft Existing and Tier 1 Recycled Water Systems TM, December 14, 2009; 2005 Urban Water Management Plan for the Los Angeles Department of Water Power, and LADWP Water Recycling Staff

use in 2010 would be approximately 16,950 AF, however actual use was lower than projected, as shown in Exhibit 4J. Environmental use of recycled water fluctuates slightly year to year based on lake levels, but is typically 26,990 AFY. For 2010 actual environmental use was 25,008 AF, or approximately 7 percent less than typical use. Overall total recycled water use in 2010 was approximately 27 percent less than projected.

Although LADWP did not meet the 2010 recycled water projection, program progress has been made, including the completion of multiple projects since 2005 as described in Section 4.3.1 through 4.3.4. Additional projects that are proposed for construction in the near future are described in Section 4.4, Recycled Water Master Planning Documents. Additionally, LADWP in conjunction with the BOS is currently developing the City’s Recycled Water Master Plan (RWMP) to guide future

optimization of this supply source with the goal of increasing municipal and industrial use of recycled water to 50,000 AFY.

**4.4 Recycled Water Master Planning Documents**

LADWP, in partnership with BOS, is developing the RWMP to identify projects to offset 50,000 AFY of potable water supplies with recycled water and to maximize recycled water use into the future. As previously discussed, in the City of Los Angeles’ Water Supply Plan, “Securing LA’s Water Supply”, LADWP established a goal of 50,000 AFY of recycled water use to reduce the need for potable water and diversify LADWP’s available water supply options. Exhibit 4K summarizes LADWP’s timeline to achieve the goal of recycling 50,000 AFY

**Exhibit 4K**  
**Recycled Water Master Planning Documents Implementation Timeline**

Timeline	Reuse Volume <sup>1</sup> (AFY)	Description
Existing as of Fiscal Year 2009/2010	6,700	Existing demands already being served
Recycled Water Use by 2015	20,000	Near-Term projects already identified for implementation by 2015
Groundwater Replenishment by 2021	15,000	New groundwater replenishment opportunities as identified as part of the Groundwater Master Plan task
Non-Potable Reuse Recycled Water by 2029	Up to 15,000	New projects identified between 2015 and FY 2029 to serve existing potable customers as part of the non-potable reuse master plan

1. Volume to offset municipal and industrial potable water demands. Does not include environmental use, in-plant reuse, and sales to WBMWD.

Source: City of Los Angeles Recycled Water Master Plan Technical Memorandum, Draft Existing and Tier 1 Recycled Water Systems TM, December 14, 2009 and LADWP Water Recycling Staff.

by fiscal year (FY) 2029. This goal can be achieved sooner if additional funds are made available, such as State and Federal grants. The RWMP efforts were initiated in 2009 and are forecast for completion by the middle of 2011. To meet Near-Term challenges and plan for long-term recycled water the following major tasks were outlined for inclusion in the RWMP:

- Groundwater Replenishment Report
- Non-Potable Reuse Report
- Groundwater Replenishment Treatment Pilot Study
- Max Reuse Concept Report
- Satellite Feasibility Concept Report
- Existing System Reliability Concept Report

Within these tasks the RWMP will recommend where the recycled water system can be effectively expanded. A cost benefit analysis will be conducted to identify projects and potential customers based on location and projected use. A review of the wastewater treatment plants will be performed to determine how much recycled water can be supplied. The RWMP will also review available

options for maximizing reuse through a combination of alternatives including expansion of non-potable irrigation/ industrial uses, and groundwater replenishment (indirect potable reuse), with advanced treated recycled water.

The RWMP will include Near-Term recycled water projects (projects to be implemented through 2015 to achieve 20,000 AFY of recycled water use), expansion of the non-potable distribution system beyond 20,000 AFY, and groundwater replenishment with advanced treated recycled water. When combined with existing reuse, these options are expected to result in 50,000 AFY of reuse by FY 2029, exclusive of environmental reuse, in-plant reuse, and sales to WBMWD. Exhibit 4K provides a timeline for projects featured in the RWMP.

Recycled water projections in five year increments beginning in 2015 through 2035 are presented in Exhibit 4L. Total recycled water use is estimated to increase by approximately 39,000 AFY or 78 percent over the projection period. Environmental reuse and seawater intrusion barrier requirements are expected to remain constant at 26,990 AFY and 3,000 AFY, respectively. Municipal and industrial use, inclusive of in-plant reuse,

### Exhibit 4L Recycled Water Use Projections

Category	Projected Use (AFY) <sup>1</sup>				
	2015	2020	2025	2030	2035
Municipal and Industrial	20,000	20,400	27,000	29,000	29,000
Indirect Potable Reuse (Groundwater Replenishment)	0	0	15,000	22,500	30,000
<b>Subtotal<sup>2</sup></b>	<b>20,000</b>	<b>20,400</b>	<b>42,000</b>	<b>51,500</b>	<b>59,000</b>
Environmental <sup>3</sup>	26,990	26,990	26,990	26,990	26,990
Seawater Intrusion Barrier (Dominguez Gap Barrier)	3,000	3,000	3,000	3,000	3,000
<b>Total</b>	<b>49,990</b>	<b>50,390</b>	<b>71,990</b>	<b>81,490</b>	<b>88,990</b>

1. Projected use by category is subject to change per completion of Recycled Water Master Plan, but overall total will not change. Does not include deliveries of 34,000 AFY of secondary treated water to WBMWD for further treatment to recycled water standards.

2. To offset potable use and included in supply reliability tables in Chapter 11.

3. Environmental use includes Wildlife Lake, Balboa Lake, and the Japanese Garden. Additional environmental benefits associated with recycled water discharges to the Los Angeles River are not included.



is expected to increase to 29,000 AFY or by approximately 45 percent. Indirect potable reuse (groundwater replenishment (GWR) with advanced treated recycled water is forecast to provide 15,000 AFY of GWR beginning in 2021. Recycled water use up to 2025 is inclusive of the Near-Term options under development in the RWMP. Projections for 2030 and 2035 assume that long-term options being developed as part of the RWMP will increase recycled water use by approximately 1,500 AFY annually beyond FY 2029. Once the alternatives for the RWMP are finalized, the allocation of recycled water use by the municipal, industrial, and GWR categories may change to achieve the RWMP's recycled water goal of 50,000 AFY by FY 2028/29.

Estimates of projected use and implementation timelines in the tables above, as well as the annual demands and service dates for individual customers in the following sections, may be affected by varying usage patterns of potential customers, timelines to reach agreements, potential financial constraints, and changing regulatory requirements.

#### 4.4.1 Near-Term Projects through 2015

"Near-Term" projects are classified in the RWMP as projects that will result in recycled water service between July 1,

2009 and 2015 to achieve approximately 20,000 AFY of recycled water use to displace potable water use. All Near-Term projects are either in the planning, design, or construction stage. Near-Term project target customers have already been identified as potential recycled water users with a total demand of 15,021 AFY. Implementation of Near-Term projects will result in the connection of approximately 40 additional recycled water customers adding to the existing 130 customers. Full implementation of Near-Term projects with existing projects will result in annual recycled water deliveries of approximately 20,000 AFY, exclusive of both environmental use and DCT in-plant use (26,990 and 2,920 AFY, respectively). Near-Term projects fall primarily in the commercial/industrial sector, followed by the irrigation sector.

#### Harbor Area

Two projects are planned to meet Near-Term demands in the Harbor Area: the Harbor Refineries Water Recycling Project and the Port of LA Harry Bridges Development, for an estimated total demand of 9,461 AFY. Uses include industrial, irrigation, and toilet flushing in commercial facilities. Most of the recycled water, approximately 9,520 AFY, will be used for industrial purposes, including cooling towers and boiler make-up water for large industrial customers. Exhibit 4M summarizes Near-Term demands for the Harbor Area.

Meeting demands in the Harbor Area will require construction of additional

#### Exhibit 4M Harbor Area Near-Term Estimated Demands

Type	Estimated Annual Demand (AFY)	Estimated Service Date
Harbor Irrigation	300	2014
Port of LA Irrigation/Commercial/Industrial	220	2015
Harbor Commercial/Industrial	9,000	2014-2015
<b>Total Harbor Area Near-Term Demands</b>	<b>9,520</b>	

Source: City of Los Angeles Recycled Water Master Plan Technical Memorandum, Draft Existing and Near-Term Recycled Water Systems TM, December 14, 2009 and LADWP Water Recycling Staff

infrastructure. Approximately 12 miles of 8- to 30-inch diameter pipeline and a 1 million gallon storage tank are proposed. All infrastructure to serve the Port of LA Harry Bridges Development will be constructed by the Los Angeles Harbor Department.

Through an agreement with WBMWD, LADWP will be supplied nitrified Title 22 water from the WBMWD Juanita Millender-McDonald Water Treatment Plant to supply recycled water to the Harbor Area.

### Metro Area

Nine water recycling projects and three customer connections are planned in the Metro Area to add annual demands of approximately 1,813 AFY. Almost all recycled water customers propose to use recycled water for irrigation. Commercial uses of recycled water include street sweeping, vehicle washing, train washing, and laundry. LAG will continue to meet all recycled water demands in the Metro Area. Exhibit 4N summarizes Near-Term demands for the Metro Area.

#### Exhibit 4N Metro Area Near-Term Estimated Demands

Type	Estimated Annual Demand (AFY)	Estimated Service Date
Irrigation	1,713	2010-2015
Commercial/Industrial	100	2011-2013
<b>Total Metro Area Near-Term Demands</b>	<b>1,813</b>	

Source: City of Los Angeles Recycled Water Master Plan Technical Memorandum, Draft Existing and Near-Term Recycled Water Systems TM, December 14, 2009 and LADWP Water Recycling Staff

Multiple facilities are required in the Metro Area to meet Near-Term demands. Approximately five pump stations ranging in size from 600 to 1,800 gallons per minute are planned for construction. Three water tanks with a combined capacity 4.75 million gallons, including the

conversion of an abandoned potable water tank in Griffith Park into a non-potable water storage tank, are necessary to meet demands. Pipeline construction will consist of 10 additional miles of pipeline ranging from 8- to 30-inch diameters, including conversion of an existing 16-inch pipeline to a 30-inch pipeline beneath Forest Lawn Road.

### Valley Area

In the Valley Area DCT will provide the potential Near-Term annual demands approximating 769 AFY. Almost all Near-Term use, except for 75 AFY, will be for irrigation purposes. These users are all located within close proximity to the existing recycled water system. Exhibit 4O summarizes the potential Near-Term demands for the Valley Area.

#### Exhibit 4O Valley Area Near-Term Estimated Demands

Type	Estimated Annual Demand (AFY)	Estimated Service Date
Irrigation	769	2010-2013
Commercial/Industrial	75	2010-2013
<b>Total Valley Area Near-Term Demands</b>	<b>844</b>	

Source: City of Los Angeles Recycled Water Master Plan Technical Memorandum, Draft Existing and Near-Term Recycled Water Systems TM, December 14, 2009 and LADWP Water Recycling staff

Only minor facilities will be required to connect Near-Term users to the existing system. Approximately 2 miles of pipeline ranging from 16- to 20-inch in diameter are proposed. Additionally, one storage tank between 1 to 1.5 million gallons, and a pump station, will be required to meet demands.

### Westside Area

LADWP will continue to acquire recycled water from WBMWD to serve Near-Term demands of approximately 350 AFY in the Westside Area. Near-Term demands

**Exhibit 4P  
Westside Area Near-Term Estimated Demands**

Project	Estimated Annual Demand (AFY)	Estimated Service Date
Irrigation		
Playa Vista Phase 2	100	2015
Westchester High School	10	2012
<b>Subtotal Irrigation</b>	<b>100</b>	
Commercial/Industrial		
LAX Cooling Towers	240	2015
<b>Subtotal Commercial/Industrial</b>	<b>240</b>	
<b>Total Westside Area Near-Term Demands</b>	<b>350</b>	

Source: City of Los Angeles Recycled Water Master Plan Technical Memorandum, Draft Existing and Near-Term Recycled Water Systems TM, December 14, 2009 and LADWP Water Recycling Staff

include increasing use within the Playa Vista development, at LAX, and by adding five new customers. Approximately two-thirds of the water will be for irrigation purposes and one-third for commercial/industrial uses in cooling towers located at LAX. Exhibit 4P summarizes Near-Term demands for the Westside Area.

Serving Near-Term demands will require limited expansion of the existing recycled water system in the area as additional users connect to the existing system. Connection of the cooling towers at LAX will require construction of an additional 0.7 miles of 12-inch diameter pipeline.

**4.4.2 Non-Potable Reuse Projects to be completed between 2015 - 2029**

Non-potable reuse projects to be completed between 2015 and 2029 are being identified through the development of the RWMP. These projects will make up the balance of recycled water demand up to the 15,650 AFY non-potable reuse goal, which will contribute to achieving the

overall city goal of 50,000 AFY of recycled water displacing potable water uses.

As presented in Exhibit 4Q, the project options would have a total demand of approximately 23,100 AFY, which is larger than the goal of up to 15,650 AFY. Ultimately, an implementation plan will be developed for the recommended project options with a target of beginning operations for all projects included in the implementation plan by FY 2029.

**Exhibit 4Q  
Project Option Demands by Service Area**

Service Area	Total Demand <sup>1</sup> (AFY)
Harbor	3,300
Metro	6,100
Valley	10,100
Westside	3,600
<b>Total</b>	<b>23,100</b>

1. Includes customers with non-potable demand estimates greater than 5 AFY.

Source: City of Los Angeles Recycled Water Master Plan Technical Memorandum, Draft Tier 2 Non-Potable Reuse Project Options, February 26, 2010

## Project Selection

An initial step for evaluating these projects involves identification of potential potable water customers that can utilize recycled water. These customers need to have sufficient demand and a viable use for recycled water. Irrigation-only customers were focused on first as they are generally easier to convert to recycled water use than commercial or industrial users. As described below, during development of the project options, potential additional recycled water customers were identified based on their non-potable water demands and distance from recycled water sources.

Next, recycled water project options were developed to meet the goal of maximizing recycled water use, while promoting cost efficiency, implementability and adaptability. Two primary steps were utilized to develop recycled water project options:

- Identification of project segments to serve each customer with non-potable demands in excess of 50 AFY.
- Identification of project options combining project segments that are linked and have similar unit costs.

The first step in the development of project options was to define general project areas based on customers with non-potable demands in excess of 50 AFY. In the project areas, transmission pipeline alignments (backbone alignments) and laterals were defined to connect customers with demands greater than 50 AFY to existing recycled water infrastructure. Alignments were then redefined to connect demand clusters of less than 50 AFY, but large enough for consideration as a large demand. Finally, distribution pipeline (laterals) alignments were determined to connect customers with demands less than 50 AFY to backbone alignments.

Initial project options and unit costs are being identified in the current phase of the RWMP. Options for non-potable

reuse transmission (purple) pipelines are considered in conjunction with options developed for groundwater replenishment (see section 4.4.3). Additional information on recycled water unit cost is presented in section 4.4.5 – RWMP Cost and Funding.

## Recycled Water Supply Sources

Recycled water availability varies by service area. Additional supplies may be required to meet longer term demands between 2015 – 2029 that may require a combination of expanding existing facilities, service connections to neighboring agencies outside the City, new facilities, and satellite treatment facilities. Satellite treatment facilities are being investigated in the Metro, Valley, and Westside service areas. The RWMP is investigating options to ensure adequate supplies are available for each service area. As part of the RWMP, LADWP met with neighboring agencies in 2009 to explore potential opportunities for regional development of recycled water reuse facilities. These agencies are listed in Exhibit 4T, in section 4.4.6, Stakeholder Process and Agency Coordination.

### 4.4.3 Groundwater Replenishment

---

As part of the RWMP, LADWP is pursuing a Groundwater Replenishment (GWR) Project, also known as indirect potable reuse, using highly purified advanced treated recycled water from DCT for spreading in existing spreading basins in the San Fernando Valley area. An advanced water treatment facility is necessary to further treat tertiary effluent from DCT to produce highly purified recycled water for recharge. A minimum GWR goal of 15,000 AFY by 2021 has been set for recharging the San Fernando Basin, a major potable water supply for LADWP. This project would recharge a minimum of 15,000 AFY of advanced treated water in the existing Hansen Spreading Grounds and possibly the

Pacoima Spreading Basins by allowing the water to percolate into the aquifer. The City anticipates having the ability to eventually deliver greater amounts of water up to 30,000 AFY to the GWR.

The RWMP includes a GWR plan outlining various operational and capital infrastructure improvements required to meet these goals. Infrastructure improvements required to implement the GWR program include an advanced water treatment facility and pipelines to convey the product water to the spreading basins. Pipelines to convey water to the Hansen Spreading Grounds are already in place and were constructed as a part of the previous recycled water initiatives for the East Valley Water Recycling Project. However, if the Pacoima Spreading Basins will also receive water for spreading, then additional pipeline infrastructure will be required.

Native stormwater recharge will continue to occur at the spreading grounds in conjunction with the project. Currently, LADWP and the Los Angeles County Department of Public Works use multiple spreading grounds located in the eastern portion of the San Fernando Basin to recharge the underlying San Fernando Basin with stormwater. A detailed discussion of the San Fernando Basin and existing recharge operations is provided in Chapter 6, Local Groundwater.

Goals for the advanced water treatment plant include as described in the RWMP are:

- Minimum capacity of 15,000 AFY with the potential to expand to 30,000 AFY.
  - Initially in service by 2021.
  - Utilization of proven technologies that have demonstrated effective removal of regulated chemicals, constituents of emerging concern, and microorganisms; additional removal of constituents of wastewater origin of interest to CDPH, including pharmaceuticals, personal care products, and endocrine disrupting compounds.
- Product water shall comply with requirements from the CDPH, RWQCB, and SWRCB and be suitable for indirect potable reuse.

To develop and implement the project expeditiously, the advanced wastewater treatment plant will be based on the recently permitted Orange County Water District Groundwater Replenishment System Project. This system provides product water for indirect potable reuse by recharging a groundwater basin used for potable water and preventing seawater intrusion. Proposed technologies include microfiltration or ultrafiltration, reverse osmosis, advanced oxidation using ultraviolet light with hydrogen peroxide, and post-treatment for product water stabilization. As a by-product of advanced water treatment, brine is created. Multiple brine disposal alternatives are presented in the RWMP, and a final alternative will be selected upon completion of the plan.

LADWP is working closely with BOS and regulatory agencies to expedite completion of the project by 2021. Current ongoing tasks include completion of the RWMP, public outreach, pilot testing of GWR treatment processes, and ongoing participation of an independent advisory panel. Environmental documentation is expected to be initiated in 2011 and completed in 2013. The RWMP also outlines the regulatory approval steps required. Regulatory requirements for GWR are discussed in sub-section 4.1.2, GWR Regulatory Requirements.

### **Independent Advisory Panel**

GWR projects typically have the involvement of an independent third party with scientific and technical expertise to provide expert peer review of key aspects of the project, which can ensure the technical viability of the GWR and facilitate the regulatory process. To accomplish this, LADWP awarded a contract with the National Water Research Institute (NWRI) to form an Independent Advisory Panel (IAP) to provide expert peer review of the technical, scientific, regulatory, and policy aspects of the proposed GWR

project, pilot project testing, and other potential groundwater replenishment projects to maximize reuse as part of the LADWP Recycled Master Planning Documents. The IAP process will provide a consistent, thorough, and transparent review of any proposed GWR projects and pilot testing during their critical formation phase, as well as during the long-term implementation phase.

NWRI has vast experience in the organization and administration of the IAP processes for other agencies such as the Orange County Water District Groundwater Replenishment System Project. NWRI will assist the IAP process by assembling the IAP members, developing a detailed scope and approach for the IAP's review, coordinating and facilitating meetings, and preparing IAP reports.

Some of the immediate activities that have been identified for the IAP to address during the initial participation include, but are not limited to review of the following:

- General approach for Recycled Water Master Planning
- Hydrogeology (in-basin groundwater blending)
- Treatment (barriers to replace the fifty-percent blend criteria)
- Reliability features of the Advanced Water Treatment Facility
- Source Control Evaluation for GWR
- Draft Engineering Report for GWR
- Response to technical concerns raised by regulators and the public

The "Independent Advisory Panel for the City of Los Angeles Groundwater Replenishment Project" consists of 13 members with scientific and/or professional expertise in issues related to the implementation of groundwater replenishment projects. The selection of members with different areas of expertise

was based on the requirements of the California Department of Public Health Draft GWR Reuse Regulations dated August 2008, as well as the composition of panels used by the Orange County Water District and the City of San Diego for the implementation of similar groundwater replenishment projects.

NWRI convened the Independent Advisory Panel for the first time in October 2010 to receive introductory information about the recycled water program and groundwater replenishment project. The Panel is expected to be involved throughout the planning, permitting, design, environmental documentation, and implementation of the groundwater replenishment project.

#### 4.4.4 Efforts Beyond 50,000 AFY

---

As part of the RWMP, LADWP is developing long-term alternatives to maximize recycled water use beyond 50,000 AFY. After 2029 and through 2035 LADWP expects to increase recycled water use by approximately 1,500 AFY annually. To maximize recycled water use LADWP is investigating the following options in its RWMP:

- Recycled water satellite treatment facilities.
- Expansion of recycled water systems.
- Increasing treatment levels at HTP to tertiary and advanced treatment.
- Reviewing opportunities for partnerships with agencies within and outside of the City.
- Treatment plant upgrades at DCT and LAG.
- Methods to increase reliability of the system.

Additionally, the RWMP will identify how the City can maximize recycled water usage into the future beyond the 50,000 AFY goal. The long-term recycled water alternatives analysis, as part of the RWMP, have not been completed. However, LADWP forecasts that in 2035, municipal and industrial recycled water deliveries along with groundwater replenishment will be approximately 59,000 AFY. In addition to this, 26,990 AFY will also be used for environmental beneficial reuse.

#### **4.4.5 RWMP Cost and Funding**

The capital cost of expanding the recycled water system to achieve the initial goal of displacing 50,000 AFY of potable water demand was initially estimated at approximately \$1 billion. This cost is being refined as part of the RWMP and is expected to be updated by mid-August 2011.

##### **Unit Cost**

Non-potable reuse and GWR projects are diverse, and result in a wide range of costs to implement and sustain. Non-potable reuse projects present numerous challenges, including distance from treatment plant and the associated transmission pipeline construction costs. This is weighed against customer size and recycled water adaptability to a particular commercial site or process. Initial findings of the RWMP have determined the approximate range of cost for water recycling projects to be from \$600 to \$1,500 per acre-foot. This approximation includes capital, operation, and maintenance costs.

##### **Funding**

Capital costs for RWMP projects will be covered by the funding sources identified below, as well as other sources as they become available.

- Water Rates – LADWP water rates are the primary funding source for the recycled water program.
- Federal Funding – LADWP will pursue Federal funding as it becomes available. In the past LADWP has received funding for recycled water projects from the Federal Water Project Authorization and Adjustment Act of 1992, Public Law 102-575 (HR429), and the United States Bureau of Reclamation Title XVI Program.
- State Funding – LADWP will pursue State funding as it becomes available, through the SWRCB and DWR for recycled water projects. Propositions 13 and 50 had funds specifically marked for recycled water projects. Funding is available through Proposition 84, Integrated Regional Water Management, for implementation projects, including recycled water projects. Low-interest loans are available through the SWRCB for eligible projects.
- MWD Local Resources Program Incentive – The Local Resources Program provides funding for water recycling and groundwater recovery projects that prevent a new demand on MWD or displace an existing demand on MWD. Financial incentives up to \$250 per acre-foot are available dependent upon MWD water rates and projects costs.

#### **4.4.6 Outreach and Agency Coordination**

Outreach with key stakeholders and the public, and coordination with agencies is necessary for the success of LADWP's recycled water program.

##### **Stakeholder Process**

To encourage input as recycled water strategies are developed over the next few years in conjunction with the RWMP,

LADWP has initiated an extensive outreach process. LADWP has developed two formats for participation of key stakeholders in the Recycled Water Advisory Group (RWAG), and for public participation in the Recycled Water Forums.

The more than 200 stakeholders invited to participate in the RWAG represent broad interests across the City, including community groups, environmental groups, neighborhood councils, homeowners' associations, and others. Approximately 65 stakeholders are participating in the process. The RWAG first met in 2009 and will have approximately five workshops per year over the next few years. Through the RWAG, stakeholders are provided the opportunity to represent their respective organizations, share input with LADWP and BOS, and convey information back to their organizations. Two main roles of the RWAG are:

1. Allow stakeholders to provide input on recycled water options from technical, environmental, financial, and social viewpoints.
2. Consider key project issues and discuss implementation challenges and acceptability.

Recycled Water Forums provide the general public an opportunity to learn

about the LADWP Recycled Water Program and submit comments that will be considered before the RWMP is adopted.

### Agency Coordination

To maximize recycled water use and move forward with RWMP efforts, LADWP closely coordinated with agencies at the local and state levels. Coordination is necessary to ensure adequate funding, identification of end-users, adequate availability of supplies, permitting and regulatory approvals, and regional cooperation. If Federal funding opportunities become available, LADWP will also coordinate with the applicable Federal agencies. Exhibit 4R provides a summary list of agencies LADWP is currently coordinating with to maximize recycled water use.

### Financial Incentives

LADWP also coordinates recycled water end use with potential customers by assisting with facility retrofits and public education. Recycled water is provided to customers at a cost less than potable water. LADWP is also considering implementing a new incentive program designed to assist with onsite retrofits to convert customers to the use of recycled water.

### Exhibit 4R Recycled Water Agency Coordination

Burbank Water and Power <sup>1</sup>	Los Angeles County Department of Public Works <sup>1</sup>
Central Basin Municipal Water District <sup>1</sup>	Metropolitan Water District of Southern California <sup>1</sup>
Glendale Water and Power <sup>1</sup>	Pasadena Water and Power <sup>1</sup>
Los Angeles County Sanitation Districts <sup>1</sup>	Water Replenishment District of Southern California <sup>1</sup>
Long Beach Water Department <sup>1</sup>	West Basin Municipal Water District <sup>1</sup>
Las Virgenes Municipal Water District <sup>1</sup>	Los Angeles Regional Water Quality Control Board
State Water Resources Control Board	Los Angeles County Department of Public Health
City of Los Angeles Department of Public Works, Bureau of Sanitation, Watershed Protection Division	City of Los Angeles Department of Public Works, Bureau of Sanitation
California Department of Public Health	

1. Met with agencies individually to discuss potential regional recycled water use.





#### 4.4.7 Recycled Water Quality

All recycled water provided by LADWP meets, at minimum, Title 22 standards. Title 22, Chapter 4, of the California Code of Regulations establishes water quality standards and treatment reliability criteria for water recycling to ensure public safety as discussed in Section 4.1. Title 22 standards are achieved with tertiary treatment and disinfection.

Advanced wastewater treatment is currently provided for the Dominguez Gap Seawater Barrier at the TIWRP by the AWTF. The AWTF has advanced treatment that includes microfiltration and reverse osmosis, which removes many of the impurities remaining after tertiary treatment and disinfection. This treatment will be implemented for the planned groundwater replenishment project being developed through the RWMP. Purified DCT effluent used to

recharge the San Fernando Basin will undergo additional treatment, including microfiltration, reverse osmosis, and advanced oxidation. Exhibit 4C, located in Section 4.2, summarizes the level of treatment provided by each of the City's water reclamation plants.



# Chapter Five Los Angeles Aqueduct System

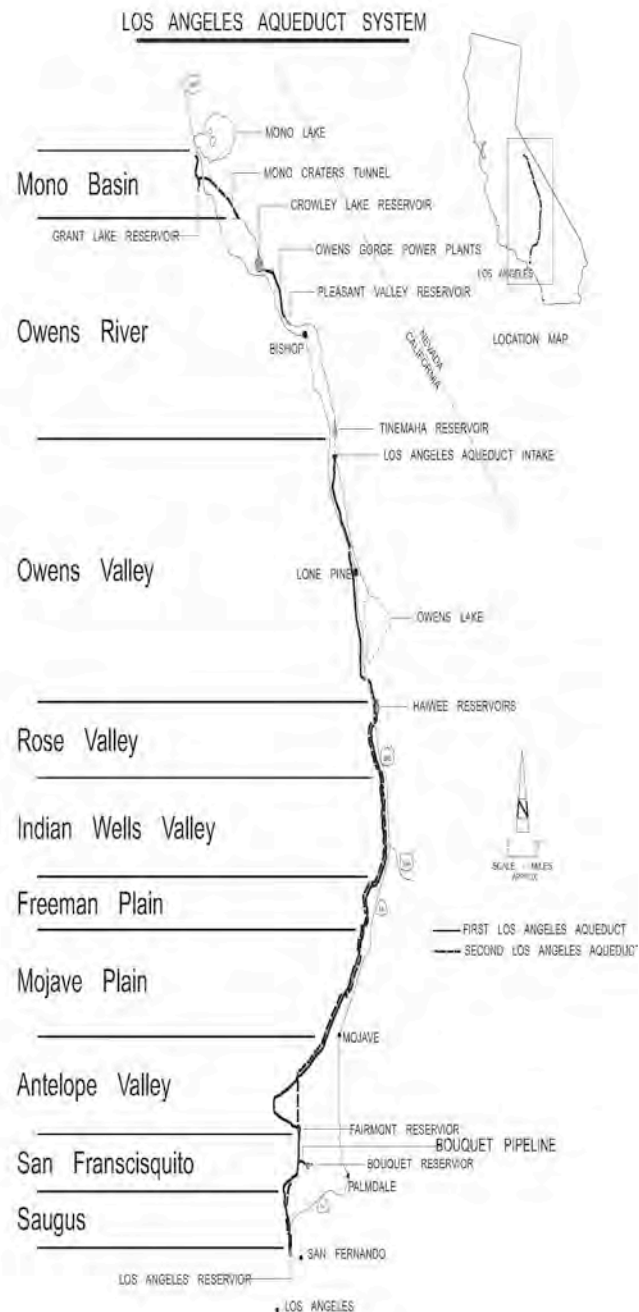
## 5.0 Overview

Water has been an integral part of the City’s history. The City’s population and economy was initially supported through a combination of local surface flows primarily from the Los Angeles River, and groundwater pumping primarily from the San Fernando Basin. When it became apparent that much of the local groundwater supply and local surface flows were fully utilized, the citizens of Los Angeles under the leadership of William Mulholland, then Chief Engineer of the Los Angeles Water Bureau, approved by a 10 to 1 margin a \$23 million bond measure to construct the First Los Angeles Aqueduct in 1913. This investment was equal to 12 percent of the entire City’s assessed valuation at that time. Then in 1940, an additional \$40 million was spent to extend the first aqueduct 40 miles north from the Owens River to streams that were tributaries to Mono Lake, see Exhibit 5A.

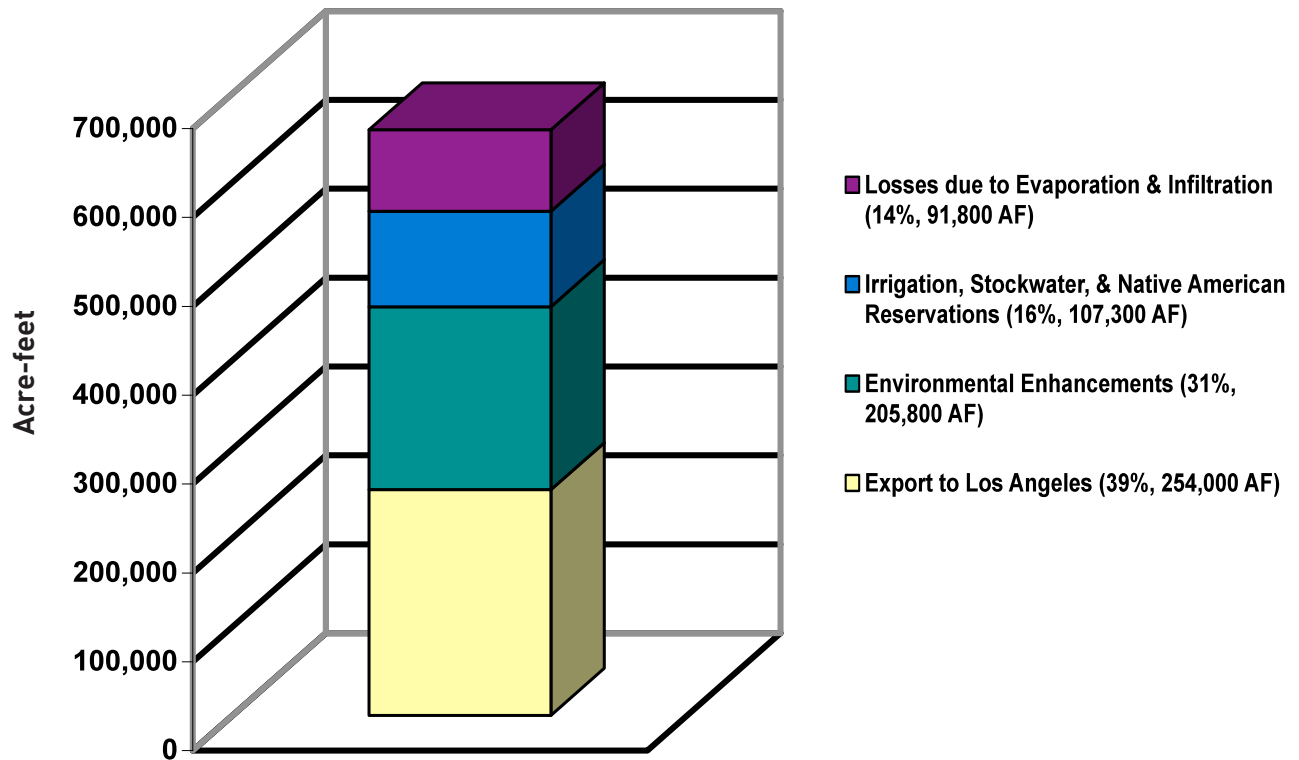
To meet the additional water needs of its population, the City decided to construct the second barrel of the Los Angeles Aqueduct in 1963, later to become known as the Second Los Angeles Aqueduct. Construction of the Second Los Angeles Aqueduct was completed in 1970. The second aqueduct increased the City’s capacity to deliver water from the Mono Basin and the Owens Valley to Los Angeles from 485 cubic feet per second (cfs) to 775 cfs.

The value of the City’s historical investment in the Los Angeles Aqueduct System is substantial. For nearly a century, the City has benefited from the delivery of high-quality, cost-effective water supplies from the eastern Sierra Nevada.

**Exhibit 5A  
Los Angeles Aqueduct System**



**Exhibit 5B  
Mono Basin and Owens Valley Water Use Allocations**



Over time, environmental considerations have required that the City reallocate approximately one-half of the Los Angeles Aqueduct (LAA) water supply to environmental mitigation and enhancement projects. As a result, the City has used approximately 205,800 AF of water supplies for environmental mitigation and enhancement in the Owens Valley and Mono Basin regions in 2010, which is in addition to the almost 107,300 acre-feet per year (AFY) supplied for agricultural, stockwater, and Native American Reservations. Limiting water deliveries to the City from the LAA has directly led to increased dependence on imported water supply from the Metropolitan Water District of Southern California (MWD). LADWP's purchases of supplemental water from MWD in FY 2008/09 hit an all time high.

As indicated in Exhibit 5B, LAA deliveries comprise 39 percent of the total runoff in

the eastern Sierra Nevada in an average year. The vast majority of water collected in the eastern Sierra Nevada stays in the Mono Basin, Owens River, and Owens Valley for ecosystem and other uses.

### 5.1 Historical Deliveries

Annual LAA deliveries are dependent on snowfall in the eastern Sierra Nevada. Years with abundant snowpack result in larger quantities of water deliveries from the LAA, and typically lower supplemental water purchases from MWD. Unfortunately, a given year's snowpack cannot be predicted with certainty, and thus, deliveries from the LAA system are subject to significant hydrologic variability.

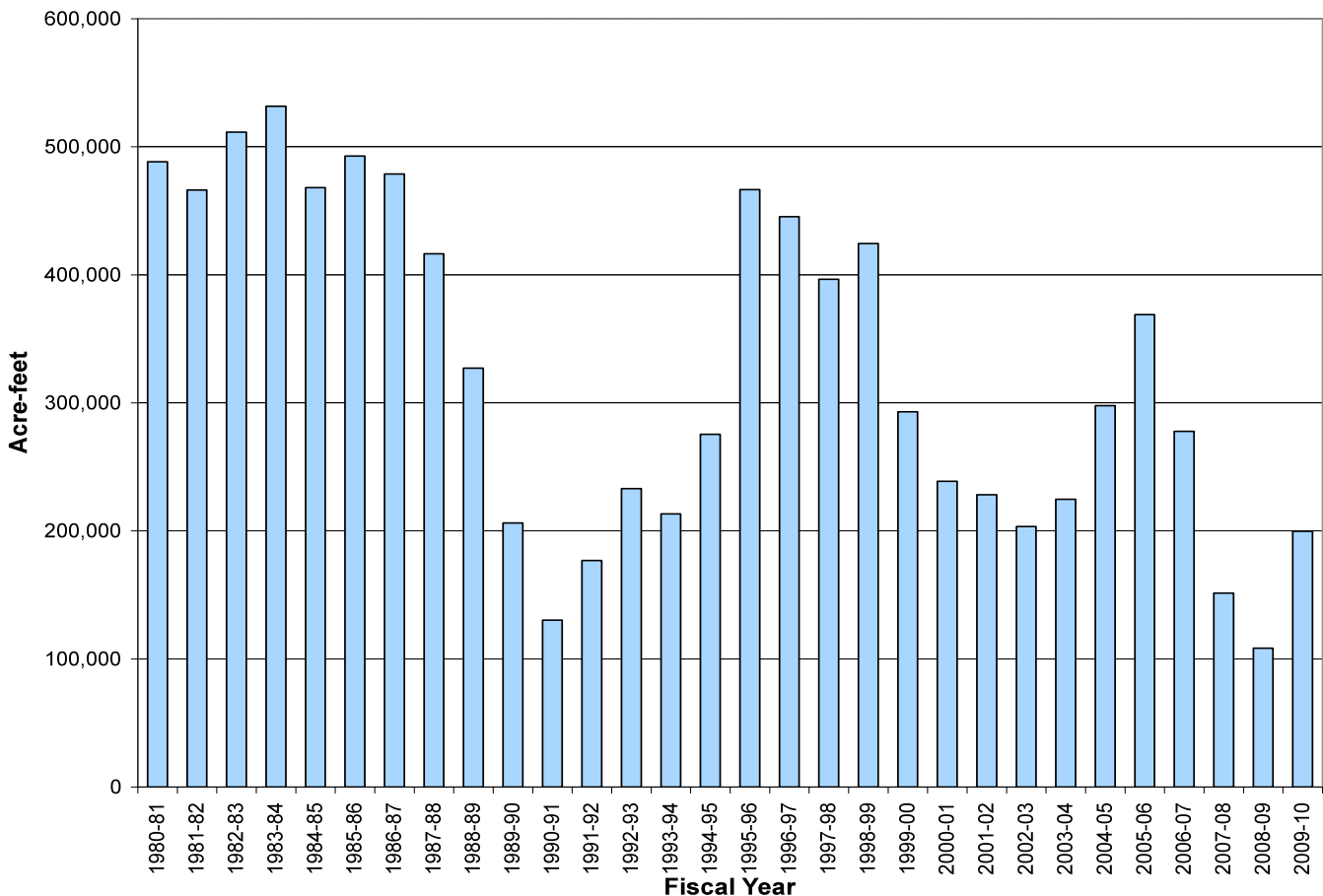
The impact to LAA water supplies due to varying hydrology in the Mono Basin and Owens Valley is amplified by the requirements to release water for environmental restoration efforts in the eastern Sierra Nevada. Since 1989, when City water exports were significantly reduced to restore the Mono Basin's ecosystem, LAA deliveries from the Mono Basin and Owens Valley have ranged from 108,503 AF in FY 2008/09 to 466,584 AF in FY 1995/96. Average LAA deliveries since FY 1989/90 have been approximately 264,799 AF, about 42 percent of the City's total water needs.

The cyclical nature of hydrology is exhibited best by LAA deliveries over the last ten years. This general period was characterized by a series of wet years, followed by a series of dry years. From FY 2000/01 through 2009/10, LAA deliveries supplied an average of 36 percent of the City's water needs. The reliability impact

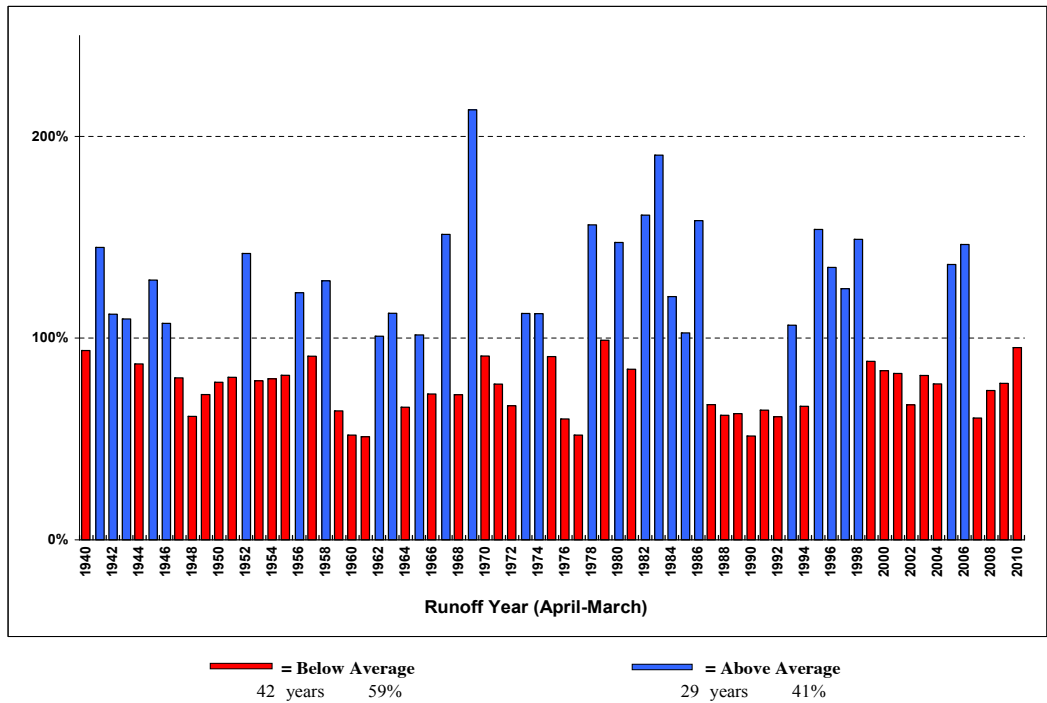
of hydrologic cycles on LAA supplies is evident through historical deliveries. A broader look at how deliveries from the LAA have fluctuated from year to year is shown in Exhibit 5C.

A long term perspective of the general cycle of wet and dry years for the Owens Valley is evident in Exhibit 5D, particularly since the late 1960s. As illustrated, reliance solely on one water supply source is not practical. Therefore, the City relies on the LAA in combination with the Colorado River Aqueduct and the State Water Project as the City's primary imported water sources. These imported sources combined with local groundwater, recycled water, and conservation make up the City's total water supply portfolio. This portfolio of water resources is fundamental to LADWP's ability to deliver a reliable water supply to meet the needs of over 4 million residents of Los Angeles.

**Exhibit 5C**  
**Historical Los Angeles Aqueduct Deliveries**



**Exhibit 5D  
Eastern Sierra  
Nevada Runoff  
Owens Valley  
- Percent of  
Normal**



**5.2 Mono Basin and Owens Valley Supplies**

Surface runoff from snowmelt in the eastern Sierra Nevada Mountains is the primary source of supply for the LAA. The LAA extends approximately 340 miles from the Mono Basin to Los Angeles. Water is conveyed the entire distance by gravity alone. LADWP regulates system output through storage control at seven reservoirs, beginning with Grant Lake Reservoir to the north and ending with Bouquet Reservoir to the south. The total combined reservoir storage capacity of the system is 300,560 AF. Hydroelectric power is also generated from 12 power plants along the LAA. Combined maximum capability of the power generation facilities is 205 megawatts. Water-gathering activities for the LAA have a junior priority to meeting the Owens Valley and Mono Basin water obligations for environmental, domestic, agricultural, and recreational water needs.

The LAA is fed by runoff from the eastern slope of the Sierra Nevada Mountains. Runoff from the eastern slope reaches its maximum in the late spring and summer, after most of the year’s precipitation has already occurred. The snowpack

in the eastern Sierra Nevada provides natural storage for the LAA system. This snowpack storage is necessary in light of the minimal primarily regulatory storage capacity along the LAA system.

**Water Rights**

The City’s export of water from the eastern Sierra Nevada is based on 166 Pre-1914 and 16 Post-1914 water right diversion licenses on various streams in the Mono Basin and Owens Valley. The majority of the City’s water rights were filed prior to 1914 with the Counties of Mono and Inyo Recorder’s Office. All Post-1914 licenses were granted by the State Water Resources Control Board (SWRCB). The most significant basis for export of surface water from the eastern Sierra Nevada is an appropriation claim in 1905 to divert up to 50,000 miner’s inches (1,250 cfs) from the Owens River at a location approximately 15 miles north of the town of Independence into the LAA for transport to Los Angeles. The City has since filed Supplemental Statements of Water Diversion and Use forms with the SWRCB for all LADWP diversions and licenses.

The City’s water right licenses in the Mono Basin were amended by the SWRCB in 1994 through the Mono Lake Basin Water

Right Decision 1631. Currently, water export from the Mono Basin is limited to 16,000 AFY based on a court order to raise the target elevation of Mono Lake and restore four streams that flow to Mono Lake.

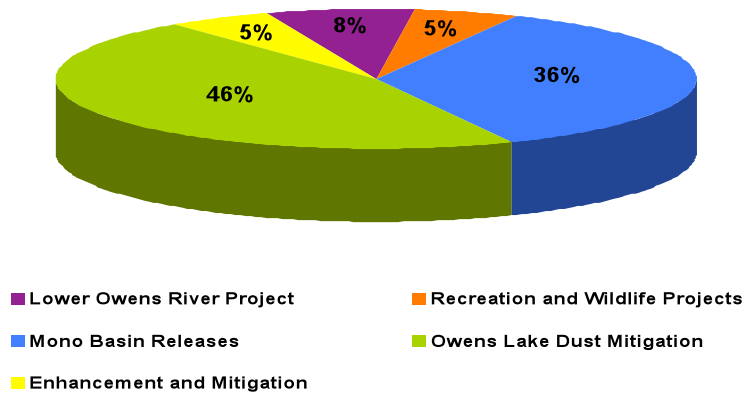
The primary groundwater right through which Los Angeles has developed groundwater resources in the Owens Valley is based on ownership of a majority of the land (approximately 314,000 acres) and associated water rights in the Owens Valley. Management of the groundwater supply in the Owens Valley is according to a 1991 agreement between Inyo County and LADWP. The goal of this agreement is to avoid defined decreases and changes in vegetation, and to cause no significant effect on the environment which cannot be acceptably mitigated, while providing a reliable supply of water for export to Los Angeles and for use in Inyo County.

### 5.3 Environmental Issues and Mitigation

Over time an increasingly larger portion of the LAA water supply has been reallocated to the environment. As a result, the City’s current supply for environmental enhancement in the Owens Valley and Mono Basin is approximately 205,800 AFY. To accommodate LAA delivery reductions due to these environmental enhancements, LADWP has funded conservation and water recycling programs to improve water use efficiency within the City. Exhibit 5E illustrates the breakdown of LAA water supply commitments by category for environmental enhancement and mitigation projects have been implemented as part of the City’s commitment to meet the environmental water needs of the Owens Valley. Among these environmental projects, LADWP is diverting 10,700 AF of water from the LAA for Owens Valley enhancement and mitigation projects, 10,400 AF for recreation and wildlife projects,

and 15,700 AF for the Lower Owens River Project (LORP). These annual environmental project diversions are in addition to water that provides environmental benefits in the Mono Basin and Owens Lake.

**Exhibit 5E**  
**Mono Basin and Owens River Environmental Enhancement Commitments**



Environmental Enhancement Commitments	AFY
Lower Owens River Project	15,700
Recreation and Wildlife Projects	10,400
Mono Basin Releases	74,000
Owens Lake Dust Mitigation	95,000
Enhancement and Mitigation	10,700
<b>Total</b>	<b>205,800</b>

### Mono Basin

Currently, Mono Basin exports will remain at no more than 16,000 AFY until Mono Lake reaches its target elevation of 6,391 feet above mean sea level. Exhibit 5F provides the maximum export levels from the Mono Basin under specified conditions as defined in the SWRCB Decision D1631 that was issued on September 28, 1994. Since the long-term average of Mono Basin exports before 1994 was approximately 90,000 AFY, the net reduction in water exports in the Mono Basin is estimated at 74,000 AFY of water mainly from Grant Lake Reservoir, Lee Vining Creek, Walker Creek, Parker Creek, and Rush Creek. As of January

## Exhibit 5F Mono Lake Elevations and Exports

Mono Lake Elevation (feet)		Exports (AFY)
Transition	< 6,377	0
	6,377 - 6,380	4,500
	6,380 - 6,391	16,000
	> 6,391	export all runoff less minimum stream flow requirements and stream restoration flows
Post-Transition	< 6,388	0
	6,388 - 6,391	10,000
	> 6,391	export all runoff less minimum stream flow requirements and stream restoration flows

## Exhibit 5G Lower Rush Creek Base and Peak Flow Requirements

Hydrologic Condition	Base Flow (cfs)							Peak Flows (cfs)
	Apr	May - Jul	Aug - Sep	Apr - Sep	Oct - Mar	May - Aug	Sep - Mar	
Dry (runoff < 83,665 AF)	N/A	N/A	N/A	31	36	N/A	N/A	None
Dry-Normal I (runoff 83,655 - 91,590 AF)	N/A	N/A	N/A	47	44	N/A	N/A	200 for 7 days
Dry-Normal II (runoff 91,590 - 100,750 AF)	N/A	N/A	N/A	47	44	N/A	N/A	250 for 5 days
Normal (runoff 100,750 - 130,670 AF)	N/A	N/A	N/A	47	44	N/A	N/A	380 for 5 days follows 300 for 7 days
Wet-Normal (130,760 - 166,700 AF)	N/A	N/A	N/A	47	44	N/A	N/A	400 for 5 days followed by 350 for 10 days
Wet (166,700 - 195,400 AF)	N/A	N/A	N/A	68	52	N/A	N/A	450 for 5 days followed by 400 for 10 days
Extreme Wet (runoff > 195,400 AF)	N/A	N/A	N/A	68	52	N/A	N/A	500 for 5 days followed 400 for 10 days

Source: Mono Basin Operations, Guidelines A-G

2011, Mono Lake is at elevation 6,382 feet. Extensive restoration and monitoring programs in the Mono Basin have improved the streams, riparian, fishery, and waterfowl habitats.

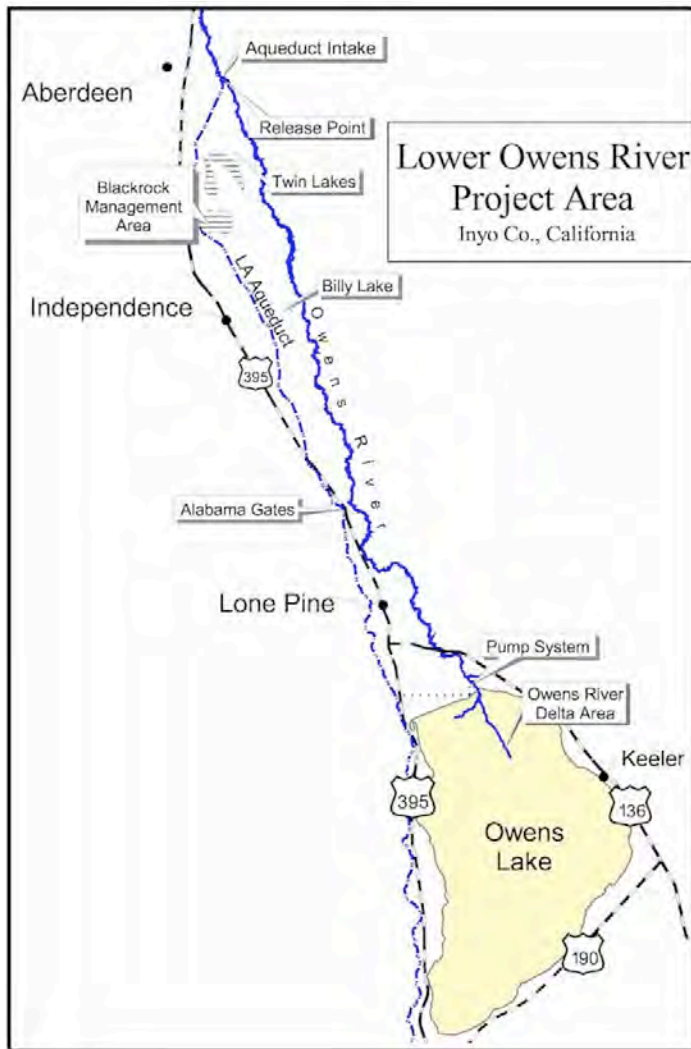
To effectively maintain continuous base and peak water flows to the ecosystem restoration area of Lower Rush Creek in the Mono Basin, LADWP completed construction of the Mono Gate One diversion facility upgrade in November 2009. Exhibit 5G summarizes the base and peak flow requirements for Lower Rush Creek. Base and peak flow requirements vary in relation to seven hydrologic conditions ranging from dry to extreme wet as identified by forecasted runoff for Mono Basin. Mono Gate One was originally constructed to release excess water from the LAA system during high

flows by diverting water into Lower Rush Creek with a system of diversion boards. However, it had no monitoring or flow control capabilities and was not designed for precise flow metering or full-time diversion. Construction completed in the fall of 2009, the new Mono Gate has enabled LADWP to greatly improve measuring and flow capabilities, satisfying one of the operational requirements of the SWRCB.

### Lower Owens River Project

Beginning December 2006, the LORP, depicted in Exhibit 5H, releases water from the LAA to create a warm water fishery along a 62-mile section of the Owens River. Water is released near the LAA intake facility and a pump back station is located downstream to return





**Exhibit 5H**  
**Lower Owens River Project Area**

**Exhibit 5I**  
**Lower Owens River Base and Peak Seasonal Habitat Flow Requirements**

Hydrologic Condition Forecasted <sup>1</sup> (Percent of Average Runoff)	Base Flow (cfs)	Peak Seasonal Habitat Flow <sup>2</sup> (cfs)
50 percent or less	40	Base flow only
70 percent	40	100
100 percent or greater	40	200

1. Runoff forecast determined by LADWP's Runoff Forecast Model for Owens River Basin based on April 1<sup>st</sup> snow survey.

2. Peak season habitat flows are proportionately ramped up from 40 cfs to 200 cfs based on the percent of average runoff forecasted greater than 50 percent and less than 100 percent.

flows to the LAA or to Owens Lake for dust control measures. In accordance with the Memorandum of Understanding between LADWP and Inyo County and the approved Environmental Impact Report, annual monitoring reports are to be prepared to measure project success. The first LORP Annual Monitoring Report was prepared in 2008.

The Memorandum of Understanding prescribes requirements for LORP flows. Both base flows and seasonal habitat peak flows are required for the LORP. A flow schedule is provided in Exhibit 5I. Seasonal habitat peak flows vary between 40 cfs (zero additional flows beyond the base flow requirements) to 200 cfs. For below average runoff years, seasonal habitat flows may be incrementally lowered from the average runoff year

requirements of 200 cfs to 40 cfs (base flow) in proportion to the forecasted runoff flows in the watershed. Base flows are constant at 40 cfs regardless of forecasted runoff flows. It is estimated that the long-term use and transit losses from the project will be approximately 15,700 AFY.

### 5.4 Owens Lake Dust Mitigation

Historically, the Owens River was the main source of water for Owens Lake. Diversion of water from the river, first by farmers in the Owens Valley and then by the City, resulted in the lake being reduced to a small brine pool. The

exposed lakebed became a major source of windblown dust resulting in the United States Environmental Protection Agency (USEPA) classifying the southern Owens Valley as a serious non-attainment area for particulates (dust) also known as PM10 emissions in 1991. The PM standard includes Particulate Matter with a diameter of 10 micrometers or less (0.0004 inches or one-seventh the width of a human hair). USEPA's health-based national air quality standard for PM-10 is 50 microgram per cubic meter (measured as an annual mean) and 150 microgram per cubic meter (measured as a daily concentration).

As a result of PM10 emissions exceeding regulations, the USEPA required California to prepare a State Implementation Plan to bring the region into compliance with Federal air quality standards by 2006. In July 1998, LADWP entered into a Memorandum of Agreement with the Great Basin Unified Air Pollution Control District that: 1) delineated the dust producing areas on the lakebed that needed to be controlled; 2) specified what measures must be used to control the dust; and 3) outlined a timetable for implementation of the control measures. The Memorandum of Agreement was incorporated into a formal air quality control State Implementation Plan by the Great Basin Unified Air Pollution Control District. The plan was approved by the USEPA in October 1999.

LADWP's water use for Owens Lake Dust Mitigation has been gradually increased over the years. Exhibit 5J summarizes yearly water use for the Owens Lake Dust Control Project. Currently, up to 95,000 AF per year of water could be diverted from the LAA for dust mitigation at Owens Lake, greatly exceeding the 55,000 AFY anticipated in the 2005 UWMP. In August 2009, the Board of Water and Power Commissioners of the City of Los Angeles required LADWP to implement water conservation measures on Owens Lake to reduce LAA diversions to below the peak of 95,000 AFY for existing and future dust control projects.

**Exhibit 5J**  
**Yearly Water Use on Owens Lake**  
**(Fiscal Year)**

Fiscal Year	Total AF
2002/03	23,937
2003/04	31,362
2004/05	29,494
2005/06	29,413
2006/07	54,849
2007/08	67,262
2008/09	59,187
2009/10	75,428
2010/11	95,000

\* Fiscal year 2010/11 is projected

Since 2001, LADWP has diverted water from the LAA for the Owens Lake Dust Control Project. A combination of shallow flooding, managed vegetation, and a small amount of gravel are used at various lakebed locations as Best Available Control Measures for dust control mitigation on almost 40 square miles. Exhibit 5K provides a description of the Best Available Control Measures. LADWP has completed 9.2 square miles of shallow flooding, 0.5 square miles of modified shallow flooding, and 0.4 square miles of sand fence as part of the Phase 7 project in accordance with the 2008 State Implementation Plan. However, LADWP had proposed 3.1 square miles of a new waterless dust control measure called Moat and Row which was disallowed by the California State Lands Commission in April 2010. LADWP is working with the District to develop an alternative solution for the areas originally proposed for Moat and Row. LADWP has been ordered to complete an additional 2 square miles of dust control known as the Phase 8 project. LADWP is seeking a lease from the California State Lands Commission to construct Gravel Best Available Control Measures for Phase 8 as it does not require water for operation.

**Exhibit 5K**  
**Dust Control Mitigation Best Available Control Measures**

Dust Control Measures		Description
Shallow Flooding	Sheet Flooding	Releases water from arrays of low-flow water outlets spaced at intervals of between 60 and 100 feet along pipelines laid along lake bed contours. Pipelines are spaced between 500 and 800 feet apart. This arrayed configuration of water delivery creates large, very shallow sheets of braided water channels. Water depths in sheet flooded areas are typically at most a few inches deep. The lower edge of sheet flooded areas has containment berms to capture and pond excess flows. The water slowly flows across the typically very flat lake bed surfaces downhill to tail-water ponds where pumps recirculate the water back to the outlets. To maximize project water use efficiency, flows to sheet flow areas are regulated at the outlets so that only sufficient water is released to keep the soil wet. Any water that does reach the lower end of the control area is collected and recirculated back through the water delivery system.
	Shallow Flooding (Pond Flooding)	Water containment berms that allow ponds to be formed that submerge the emissive lake bed areas. These ponds are up to four feet deep. The containment berms are typically rock-faced to protect them from delivery to the pond area until the pond reaches a size and depth sufficient to submerge the required amount of emissive water. Water delivery then ceases until evaporation reduces the pond size to a set minimum.
Managed Vegetation		Control measure consists of creating a farm-like environment from barren playa. The saline soil must first be reclaimed with the application of relatively fresh water and then planted with salt-tolerant plants that are native to the Owens Lake basin. Thereafter, soil fertility and moisture inputs must be managed to encourage rapid plant development and maintenance. Existing Managed Vegetation areas are irrigated with buried drip irrigation tubing and a complex network of buried drains to capture excess water for reuse on the Managed Vegetation area or in Shallow Flooding areas. Managed Vegetation is sustainable at Owens Lake only if salt from the naturally occurring shallow groundwater is prevented from rising back into the rooting zone.
Gravel Blanket		A four-inch layer of coarse gravel laid on the surface of the Owens Lake playa will prevent emissions by preventing the formation of efflorescent evaporate salt crusts, because the large pore spaces between the gravel particles disrupt the capillary movement of saline water to the surface where it can evaporate and deposit salts. The gravel also creates a surface that has a high threshold wind velocity so that direct movement of the large gravel particles is prevented and the finer particles of the underlying lake bed soils are protected. Gravel Blankets are effective on essentially any type of soil surface.

As part of an Interim Management Plan, LADWP and Inyo County have agreed to conduct a joint study to explore the feasibility of extracting and utilizing brine laden groundwater beneath Owens Lake to supplement the water supply necessary for dust mitigation activities. This feasibility study is scheduled for completion by November 2011. If groundwater pumping is considered feasible and acceptable, LADWP will first need to obtain required approval from Great Basin Unified Air Pollution Control District, California State Lands Commission, California Department of Fish and Game, and Inyo County.

### 5.5 Water Quality

As land owners of much of the Mono Basin and Owens River watersheds, LADWP has placed strict limits on the extent of development impacting the City-owned watersheds. Snowmelt from the eastern Sierra Nevada contains low total organic carbon (TOC), bromide concentrations, and other constituents that can form disinfectant byproducts during the water treatment process. LADWP conducts routine monitoring of all of its water supplies for over 170 constituents and contaminants. Ninety-eight of the constituents and contaminants have enforceable standards.

The LAA supply is the main source of arsenic in LADWP's water supply. Arsenic is collected as the Owens River flows volcanic formations in the vicinity of Hot Creek in Long Valley. Geothermal springs in these areas have arsenic concentrations of around 200 parts per billion (ppb). Concentrations are dramatically reduced as water in the area mixes with snow melt and other pristine water sources. Historic untreated LAA water arsenic concentrations have ranged from 10 to 74 ppb. During the latest 3-year routine compliance monitoring cycle from 2007 to 2009, the highest arsenic concentration after treatment was 8.1 ppb, while the average arsenic concentration within LADWP's water distribution system was 3.3 ppb, both well below the current Federal and State drinking water standard of 50 ppb. In light of potential, more stringent arsenic regulations, LADWP is taking a proactive approach in addressing this issue by investigating and planning enhanced coagulation treatment.

LADWP completed an evaluation and preliminary design report for enhanced coagulation at the Los Angeles Aqueduct Filtration Plant in December 2006 as a means of addressing future water quality regulations faced by LADWP, including arsenic. An enhanced coagulation facility using the process as outlined in the report is planned as part of the treatment process at the Los Angeles Aqueduct Filtration Plant by 2021.

To comply with the Stage 2 Disinfectants and Disinfection Byproducts Rule, another water quality improvement effort being implemented is the conversion from chlorine to chloramine residual disinfectant. This transition, which is expected to be completed by April 2014, will allow LADWP to maintain the same high level of disinfection in its water supply while freeing itself from other potential disinfection issues associated with the use of chlorine. The use of chloramines will provide additional operational flexibility by allowing the blending of purchased MWD water (which is chloraminated) into the LADWP distribution system without the problems

associated with creating a chlorine/chloramines interface when blending the two supplies.

## 5.6 Projected Deliveries

---

Near-term water deliveries are forecasted for the LAA using two models, the Runoff Forecast Model and the Los Angeles Aqueduct Simulation Model (LAASM). These two models used accurately predict the amount of water available from this the LAA.

The Runoff Forecast Model is used to predict total Owens Valley and Mono Basin stream runoff. The model's estimating equations were developed using historic rainfall and snowfall, as well as streamflow data of each year. Model input consists of 6 months of antecedent rainfall and streamflow data, as well as the final snowpack levels on April 1st. The model's output is the forecasted runoff for the Owens Valley and Mono Basin during the twelve month period following April 1st, assuming that median rainfall occurs during those twelve months.

Runoff flows from the Owens Valley to the City of Los Angeles are modeled by the LAASM. LAASM uses the output of the Forecast Model as input, along with estimates of various uses within the Owens Valley. LAASM uses historically derived estimating equations to forecast various losses, including evaporation and infiltration, as well as other inflows such as unmetered springs. The final output from LAASM is the volume of LAA water projected to be delivered to the City of Los Angeles.

Taking the foreseeable factors discussed earlier in this chapter into consideration, the average annual long-term LAA delivery over the next 25 years, using the 50-year average hydrology from FY 1956/57 to 2005/06, is expected to be approximately 254,000 AFY and gradually decline to 244,000 AFY due to climate

change impact. Deliveries for a series of dry years, using FY 1988/89 through 1992/93 hydrology, are expected to range from approximately 48,520 AFY to 105,770 AFY. A single dry year minimum of 48,520 AFY is expected with a repeat of the FY 1990/91 hydrology. Detailed projections of LAA deliveries by year are provided in Chapter 11, Water Service Reliability Assessment.

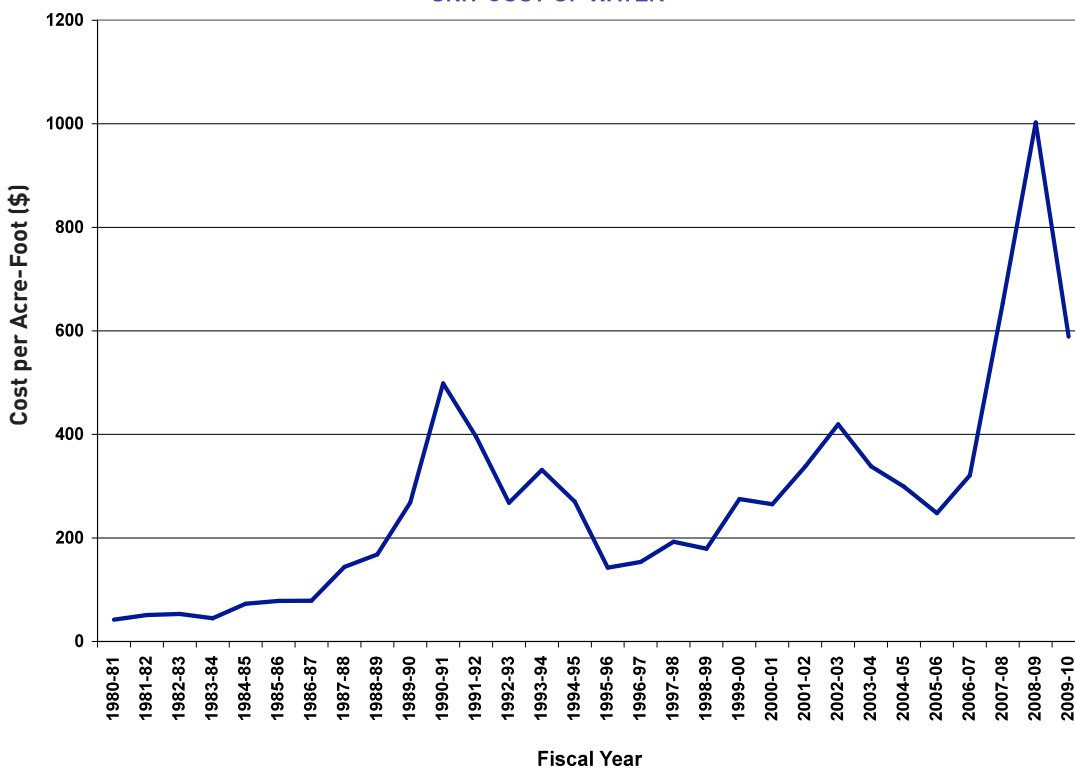
## 5.7 LAA Delivery Cost

The costs associated with the LAA water supply are primarily operation and maintenance costs. Therefore, the unit cost of importing water through the LAA to the City varies mainly with the quantity of water delivered, which is highly

dependent on hydrological conditions. During dry years, the amount of water delivered to the City decreases, which results in an increase to the unit cost. Over the years, eastern Sierra Nevada environmental enhancement project have also contributed to rising overall LAA delivery cost. The Owens Lake Dust Mitigation and Lower Owens River Project are two examples. Exhibit 5L summarizes the historical unit cost of treated water from the LAA. The peaks occurred when LAA deliveries significantly decreased during FY 1990/91, 2002/03, and 2008/09 with the LAA delivering 130,300 AF at \$499/AF; 203,400 AF at \$419/AF; and 108,500 AF at \$1,003/AF respectively.

Exhibit 5M shows the unit cost of LAA treated water from FY 2005/06 to 2009/10. The 5-year average was \$563/AF. The sharp increase in FY 2008/09 was due to LAA deliveries being the lowest on record.

### LOS ANGELES AQUEDUCT TREATED WATER UNIT COST OF WATER



**Exhibit 5L  
Historical  
Cost of LAA  
Treated  
Water**

Fiscal Year	2005/06	2006/07	2007/08	2008/09	2009/10
Unit Cost	\$248	\$321	\$654	\$1,003	\$589

**Exhibit 5M  
Annual Unit  
Cost**



# Chapter Six Local Groundwater

## 6.0 Overview

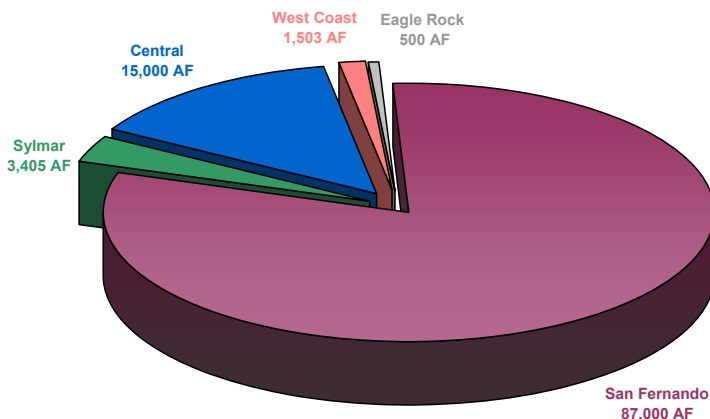
A key resource that the City has relied upon as the major component of its local supply portfolio is local groundwater. Over the last ten years local groundwater has provided approximately 12 percent of the total water supply for Los Angeles, and historically has provided nearly 30 percent of the City’s total supply during droughts when imported supplies become less reliable. In recent years, contamination issues have impacted LADWP’s ability to fully utilize its local groundwater entitlements. Additionally, reduction of natural infiltration due to expanding urban hardscape and channelization of stormwater runoff has resulted in declining groundwater elevations. In response to contamination issues and declining groundwater levels, LADWP is working on treatment for the San Fernando Basin’s (SFB) groundwater and is making investments to recharge local groundwater basins through

stormwater recharge projects, while at the same time replacing or rehabilitating old and deteriorating stormwater capture facilities. LADWP anticipates that groundwater treatment facilities in SFB will be in operation by Fiscal Year Ending (FYE) 2021 which will allow LADWP to pump its full groundwater entitlement. With the addition of utilizing stored water credits in the San Fernando Basin and Sylmar Basin, groundwater pumping will increase up to 111,500 Acre-Feet (AF) starting FYE 2021.

## 6.1 Groundwater Rights

The City owns water rights in the San Fernando, Sylmar, Eagle Rock, Central, and West Coast Basins. All of these basins are adjudicated by decree through Superior Court Judgments (Appendix F). The combined water rights in these

### Exhibit 6A Annual Local Groundwater Entitlement



Total: 107,408 AF per year

basins total approximately 107,408 AFY. Water rights in the Upper Los Angeles River Area (ULARA), which comprises the San Fernando, Sylmar, and Eagle Rock basins, total approximately 90,905 AFY which translates into approximately 87,000 AFY in the SFB, 500 AFY in the Eagle Rock Basin, and 3,405 AFY in the Sylmar Basin. Water rights in the Central and West Coast Basins are 15,000 AFY and 1,503 AFY, respectively. However, LADWP does not exercise its pumping rights in Eagle Rock Basin and West Coast Basin at this time. Exhibit 6A summarizes the City's annual local groundwater entitlements by basin.

### **The ULARA Groundwater Basin Adjudication**

The City's entitlements in the San Fernando, Sylmar, and Eagle Rock Basins were established in a Judgment by the Superior Court of the State of California for the County of Los Angeles in Case No. 650079, The City of Los Angeles, Plaintiff, vs. Cities of San Fernando, et. al., Defendants, dated January 26, 1979 (San Fernando Judgment) and the 1984 Sylmar Basin Stipulation (1984 Stipulation). Appendix F contains the Judgment and 1984 Stipulation. The Judgment was based on maintaining a safe yield operation for the basin, whereby groundwater extractions over the long-term will be maintained in a manner that does not create an overdraft condition in the basin. The Judgment and 1984 Stipulation limit groundwater extraction and establish a court-appointed Watermaster and an Administrative Committee made up of a representative from each of the five water supply agencies overlying the ULARA Basins. The five public agencies are the City of Los Angeles, the City of Glendale, the City of San Fernando, the City of Burbank, and the Crescenta Valley Water District.

The Watermaster assists the Court in administering and enforcing the provisions of the San Fernando Judgment and 1984 Stipulation. Among other duties, the Watermaster monitors

groundwater levels, recharge operations, recycled water use, extractions, water imports and exports, and reports all significant water-related events in the Basin to the Court and to the parties of the Judgments. The activities of the Watermaster are key components for the effective management of the groundwater resources in the ULARA Basins. Key tasks of the Watermaster for the SFB include:

- To monitor radiological and synthetic organic compounds (SOCs) every three years.
- To continue to work with key regulators, such as the Los Angeles Regional Water Quality Control Board (LARWQCB), California Department of Public Health (CDPH), California Department of Toxic Substance Control (CDTSC), and the United States Environmental Protection Agency (USEPA), to expedite clean-up of groundwater at or near known contamination sites.
- To continue to support the ongoing activities of the City of Los Angeles and others to recharge the groundwater basin at existing spreading basins on the east side of the San Fernando Valley.
- To help determine the technical feasibility of using advanced treated recycled water to recharge the groundwater basin.
- To continue to work with the Los Angeles Department of Public Works, Bureau of Sanitation, Watershed Protection Division, to enhance groundwater recharge of local basins via the Standard Urban Stormwater Mitigation Plans (SUSMP) procedures for stormwater infiltration at new development and redevelopment project sites.
- To work with local purveyors in an effort to increase the quantity and quality of the groundwater database for the entire ULARA basin.



**Exhibit 6B**  
**Local Groundwater Basin Supply**  
 Fiscal Year (July through June in AF)

Groundwater Basin	2005/06	2006/07	2007/08	2008/09	2009/10	Average	Percentage
San Fernando	35,486	75,640	57,060	49,106	62,218	55,902	79%
Sylmar	1,844	3,901	4,046	576	2,998	2,673	4%
Central	13,290	13,358	12,207	11,937	11,766	12,512	17%
Total	50,620	92,899	73,313	61,619	76,982	71,087	100%

**Historical Groundwater Production**

On average over the past five years, about 83 percent (58,575 AFY) of the City’s local groundwater supply was extracted from ULARA groundwater basins, while the Central Basin provided 17 percent (12,512 AFY). Exhibit 6B summarizes the City’s local groundwater production by basin over the last five years.

Historically, LADWP operates groundwater production by utilizing conjunctive use of surface water and groundwater to optimize the supply and demand balance. Through conjunctive use, the timing of groundwater extractions can be used to meet varying demands. In the past, LADWP prevented groundwater overdraft during multiple dry years through strategic pumping. When successive dry years occurred, LADWP pumped at greater than average rates for the first few years of the drought, and then pumped at lower rates in subsequent years.

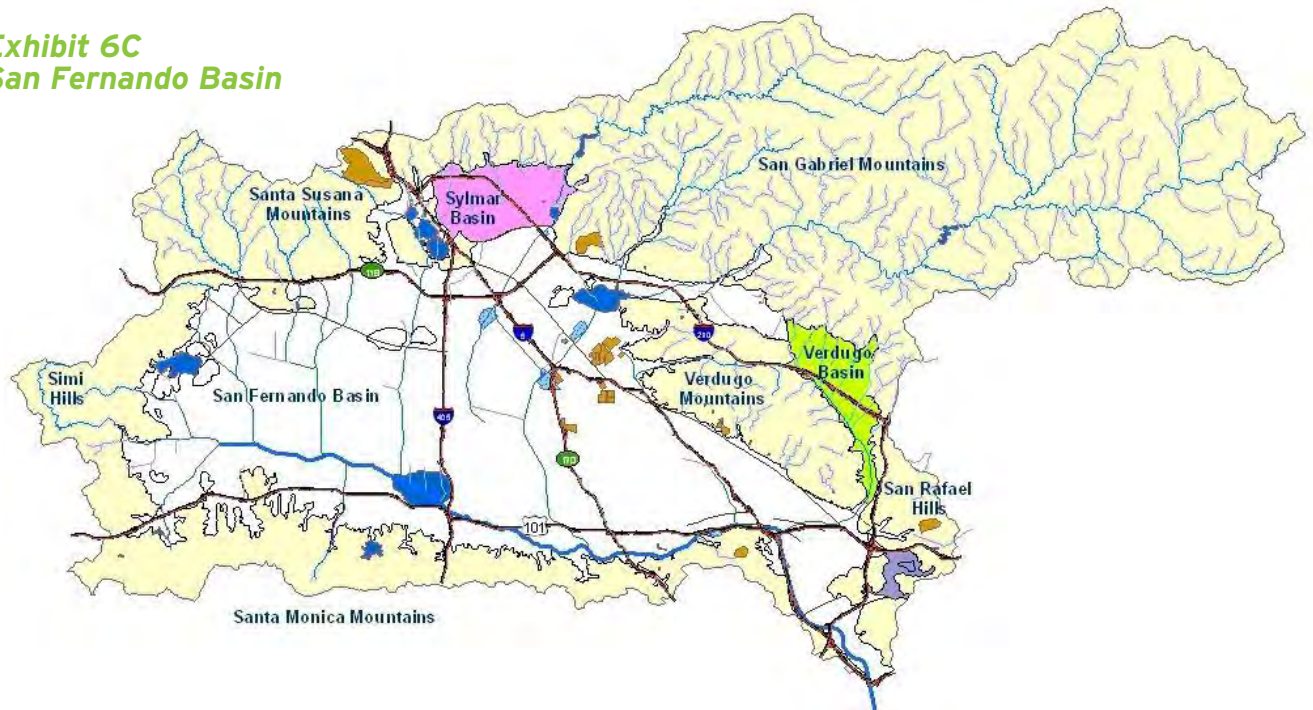
Since 2007, groundwater contamination issues in the SFB have greatly limited LADWP’s ability to pump its full groundwater entitlement. As a result, LADWP has been pumping the maximum amount of water not impacted by contamination and therefore has not been able to utilize conjunctive use strategies for groundwater operations. When the clean-up of the SFB is complete, LADWP will be able to return to these strategic pumping strategies to ensure reliability and protect against groundwater overdraft in dry years.

**6.2 San Fernando Basin**

The primary source of local groundwater for the City is the SFB, which provided over 79 percent of the City’s groundwater supply ranging from 35,486 AFY to 75,640 AFY during the period FY 2005/06 to FY 2009/10. The SFB is the largest of the four ULARA basins. The SFB consists of 112,000 acres and comprises 91.2 percent of the total area in ULARA. It is bounded on the east by the Verdugo Mountains; on the north by the Little Tujunga Syncline and the San Gabriel and Santa Susana Mountains; on west by the Simi Hills; and on the south by the Santa Monica Mountains. A map of the basin is shown in Exhibit 6C. (ULARA Watermaster Service Report, Water Year [October to September] 2008/09)

LADWP has ten major wellfields within the SFB containing 115 wells: the Crystal Springs, Headworks, Tujunga, Rinaldi-Toluca, North Hollywood, Erwin, Verdugo, Whitnall, Pollock, and North Hollywood Operable Unit Wellfields. Of the ten major wellfields, LADWP is currently not pumping only at Headworks. These wells were generally installed over a period spanning from 1924 to 1991, with the most recent installations being the Rinaldi-Toluca Wellfield in 1988 and the Tujunga Wellfield in 1991. Collectively these ten wellfields have the ability to pump and serve approximately 547 cubic feet per second (cfs) of water, of which the recent Rinaldi-Toluca and Tujunga wells comprise about 38 percent or 210 cfs.

## Exhibit 6C San Fernando Basin



### Groundwater Rights

In accordance with the San Fernando Judgment, the City has the right to all native water within the SFB, based on its Pueblo Rights, and has the right to City water that is imported and returns through infiltration into the SFB. With the native safe yield being fixed at 43,660 AFY and the return of imported water averaging approximately 43,000 AFY, the combined total equates to an average SFB entitlement for the City of approximately 87,000 AFY. The return of imported water right for LADWP is based on 20.8 percent of all water delivered within the San Fernando Basin including recycled water. The Judgment provides for storage of water within the basin when the amount pumped is less than the annual entitlement, and a portion of these stored water credits can be pumped in future years to supplement the City's water supply. The direct spreading of both imported and recycled water receives 100 percent stored water credit. Increasing LADWP's groundwater pumping rights due to stormwater capture activities will require an amendment to the San Fernando Judgment based on a demonstrated increase in groundwater levels.

In September 2007, the Cities of Los Angeles, Glendale and Burbank entered

into a ten-year Interim Agreement for the Preservation of the San Fernando Basin Water Supply (Interim Agreement). The Interim Agreement is intended to address the overall long-term decrease in stored groundwater within the basin. The Interim Agreement restricts withdrawal of stored water credits and incorporates basin losses into groundwater basin accounting.

Under the Interim Agreement, stored water credits will be reduced for each party by 1 percent annually to account for outflow from the basin. Additionally as described in the Interim Agreement, a proportion of stored water credits available for use during a water year (Available Credits) will be calculated each year, and that proportion not available for use during a given year (Reserve Credits) will be reserved for later use. As of October 1, 2009, the City had a stored water credit of nearly 406,313 AF in the SFB, however LADWP's Available Credit or maximum allowable withdrawal of stored water credits for the year beginning October 1, 2009 was 108,574 AF. LADWP's Reserve Credits total was 321,316 AF. Reserve Credits (stored water credits minus available stored water credits) will not be available until groundwater levels in the basin recover to a level that will allow for their safe withdrawal. Total Reserve Credits held by all parties in the basin were 376,433 AF as of October 1, 2009.

## Water Quality

During well testing in the SFB, trace levels of the contaminants trichloroethylene (TCE), perchloroethylene (PCE), and other volatile organic compounds (VOCs) were detected in the past. The presence of these contaminants is due to improper chemical disposal practices historically conducted by numerous companies in the San Fernando Valley utilizing such materials. Additionally, in the 1990s, detectable amounts of hexavalent chromium and perchlorate were found in various wells within the SFB. Since the 1990s, SFB wells have also shown a trend of increasing nitrate levels. The source of nitrates is the result of decades of agricultural activity in the San Fernando Valley.

While LADWP is permitted to withdraw its allotted entitlement of 87,000 AFY from the SFB including a portion of its additional stored water, 2007 was the first year LADWP was unable to pump its allotted entitlement due to contamination impacts. LADWP has 115 wells in the SFB of which 57 wells have been inactivated due to contamination. These inactive wells represent a lost pumping capacity of approximately 236 cfs or 44 percent of LADWP's pumping capacity. Of the remaining 58 active wells, with a combined pumping capacity of approximately 304 cfs, 45 have recorded concentrations for various contaminants above the Maximum Contaminant Level (MCL). Most notable among these contaminants of concern are the VOCs (especially TCE, PCE, and carbon tetrachloride), nitrates, and perchlorate. The remaining 13 wells have recorded marginal levels of contamination, mostly due to VOCs. Hexavalent chromium threatens to be a significant future risk to LADWP's wells. Lastly, LADWP's two largest wellfields, Tujunga and Rinaldi-Toluca, which were the most recently-installed wells in an area believed to be outside the known contamination areas, are being significantly impacted by unknown contamination sources.

LADWP has developed programs to accelerate treatment for the SFB groundwater which includes a comprehensive Groundwater System Improvement Study, installing monitoring wells, interim wellhead treatment, and working with regulatory agencies and government officials to identify those responsible for the contamination.

## Agency Cooperation of SFB Remediation

LADWP actively coordinates with the CDPH, LARWQCB, CDTSC, and USEPA to pursue protective and remedial measures for the SFB. The CDPH, LARWQCB, and CDTSC are the three regulatory agencies with enforcement responsibilities within the SFB. The LARWQCB and the CDTSC issue enforcement directives for pollutant sites and guide the development of cleanup workplans and the cleanup of polluted groundwater sites. The CDPH oversees the quality of potable water from groundwater sources.

In 1987, LADWP entered into a Cooperative Agreement with the USEPA to conduct the "Remedial Investigation of Groundwater Contamination in the San Fernando Valley." Under this agreement, LADWP has received funds from the USEPA's Superfund Program to carry out: (1) construction, operation, and maintenance of the North Hollywood Operable Unit, which consists of a groundwater treatment facility and a system of eight production wells (construction completed in 1989); and (2) completion of the Remedial Investigation to characterize the SFB and the nature and extent of its groundwater contamination. The Remedial Investigation included: (a) the installation in 1992 of 88 shallow and clustered monitoring wells that were developed to monitor contamination plumes of TCE, PCE, and nitrates in the SFB; (b) the development of a groundwater flow model (Flow Model) and the preparation of the Remedial Investigation report that was completed for the USEPA in 1992; and (c) on-going monitoring for TCE, PCE, nitrates, and emerging contaminants.

The Flow Model is a three-dimensional computer simulated model of the SFB based on the MODFLOW model program code that was developed by the United States Geological Survey. It consists of four layers that represent the various depth zones of the SFB. Geologic and hydrogeologic data for the basin, which was generated through field investigation, was analyzed to develop the physical site characterization of the basin for the MODFLOW Flow Model. The Flow Model produced simulated groundwater levels, gradients, and their fluctuations as a function of time. Based on field monitoring and Flow Model simulations, groundwater production strategies are reviewed and adjusted monthly to balance the City's water supply need with SFB management.

### **San Fernando Basin Treatment**

In coordination with other agencies, LADWP has completed or is planning various projects to maintain its rights to use the SFB as a reliable local water supply for the City. The following are some of LADWP's completed, current, and planned projects for the SFB. Recharge projects are discussed separately in Chapter 7, Watershed Management.

### **Groundwater System Improvement Study**

LADWP is working on a 6-year, \$19.0-million Groundwater System Improvement Study (GSIS) in the SFB that will provide vital information to assist in developing both short- and long-term projects to maximize the use of the SFB. The \$11.5-million GSIS professional service contract was awarded in February 2009.

The GSIS will aim to cover the following main objectives:

- Provide an independent study to identify, characterize, and evaluate emerging water quality constituents for the San Fernando Basin.

- Provide an independent expert evaluation of LADWP's existing groundwater facilities and its current operational strategies to address current issues on water quality regulations and groundwater treatments. Provide expert advice on the need of refurbishing existing groundwater wells.
- Research and evaluate the need for the installation of new monitoring wells in the SFB to characterize the basin for the constituents of concern.
- Develop a research monitoring program to characterize the nature and extent of the various constituents of concern that may pose a risk to LADWP maximizing the utility of the SFB.
- Provide independent expert recommendations on economically feasible short and long-term capital improvement projects to address all regulatory agency requirements.

Through the GSIS, LADWP has begun developing a conceptual layout for Groundwater Treatment Facilities in the SFB that will include treatment facilities in the vicinity of LADWP's North Hollywood, Rinaldi-Toluca, and Tujunga Well Fields. It is anticipated that construction of the Groundwater Treatment Facilities could begin as early as July 2016. Construction of the Groundwater Treatment Facilities will greatly reduce LADWP's reliance on costly and scarce imported water supplies. The Groundwater Treatment Facilities will also enable LADWP to benefit from its activities to enhance local supplies through groundwater recharge and stormwater projects. An integral part of LADWP's Groundwater Treatment Facilities will be to work closely with the USEPA and the Cities of Burbank and Glendale to ensure that the facilities operations do not adversely affect the on-going cleanup activities being conducted by the aforementioned agencies. Towards this end, LADWP plans to enter into a Groundwater Management Plan with the USEPA.



As of November 2010, the work progress has included: a technical review of USEPA's Focused Feasibility Study for the North Hollywood Operable Unit; preparation of conceptual layouts and renderings for the proposed Groundwater Treatment Facilities in the vicinity of the North Hollywood, Rinaldi-Toluca and Tujunga Well Fields; providing assistance in the planning aspects for the installation of approximately 40 new monitoring wells in the San Fernando Basin; and providing an independent study to identify, characterize and evaluate emerging water constituents.

#### **Tujunga Wellfield Joint Project**

LADWP and MWD have developed a joint project utilizing simple liquid-phase granular activated carbon to recover the use of two of the City's contaminated groundwater production wells in the Tujunga Wellfield. The total estimated cost of this project was approximately \$7.0 million and was completed in November

2009. LADWP received the permit from the CDPH in May 2010 and started to discharge into the distribution system on May 18, 2010.

#### **Tujunga Wellfield Contamination**

The Initial Discovery of the source of contamination at the Tujunga Wellfield by the USEPA and CDTSC is ongoing. Phase I is completed and has not conclusively identified the source of the contamination. The next phase will involve drilling 4 to 7 deep monitoring wells immediately up gradient of the wellfield to determine the direction of the contamination plumes. The well drilling is expected to be completed late 2012. LADWP is intending to construct up to 22 additional monitoring wells near other wellfields south of the Tujunga Wellfield. Water quality data from the new monitoring wells will assist with further characterizing the groundwater contamination in the SFB. Drilling of these additional wells is expected to begin in Fall 2011 and continue until Winter 2013.

### **North Hollywood Operable Unit**

In 1989, the North Hollywood Operable Unit was placed into service with a capacity of 2,000 gallons per minute, or 3,230 AFY. This facility has one aeration tower with vapor-phase granular activated carbon air emissions control system. This technology uses air to remove the VOCs from the groundwater and uses the vapor-phase granular activated carbon to remove the VOCs from the air stream before it exits into the atmosphere. The fifteen year consent decree expired on December 31, 2004, however, the VOC plume has not been completely remediated. In Water Year 2008/2009, 1,038 AF of VOC contaminated groundwater was treated.

The USEPA is expected to start construction of the North Hollywood Operable Unit Second Remedy possibly as soon as 2014 to improve containment of contamination from two sites, the Honeywell and Lockheed sites. The primary plume contains high concentrations of VOCs, chromium, and other contaminants of concern. The USEPA issued the Record of Decision in September of 2009. The first technical meeting with the potentially responsible party was held in July 2010. A consent decree is expected in late 2011. The Record of Decision recommends more than doubling the capacity plus adding liquid phase granular activated carbon (a secondary treatment), construction of up to 37 monitoring wells, three new extraction wells, deepen existing well #1, rehabilitation of existing wells, and treatment of chromium and 1-4 Dioxane. As of 2010, Honeywell is continuing its removal of chromium plume at the source of contamination.

### **Chromium Treatment Research**

A cost-effective treatment technology to remove low levels of hexavalent chromium from water does not exist for large scale applications. In 2001, LADWP, along with the Cities of Burbank, Glendale, and San Fernando, and the National Water Research Institute, entered into a research partnership with the American Water Works Association

Research Foundation to identify and bench-test new technologies that can remove hexavalent chromium to extremely low levels. This research is being conducted in anticipation of a new standard for hexavalent chromium.

### **Pollock Wells Treatment Plant**

In 1999, the Pollock Wells Treatment Plant was constructed and placed in service. This project was funded by LADWP, and it includes a groundwater treatment facility with four liquid-phase granular activated carbon units. Over 3,000 gallons per minute (4,840 AFY) of groundwater is treated by direct adsorption with granular activated carbon to remove VOCs before delivery to customers.

### **Remedial Investigation**

In 1992, the Remedial Investigation to characterize the nature and extent of groundwater contamination in the SFB was completed for the USEPA. The Remedial Investigation activity included the construction of 88 shallow and clustered monitoring wells, which were developed to monitor contamination plumes of TCE, PCE, and nitrates in the SFB. These monitoring wells are also being used to monitor for emerging chemicals.

### **Biological Treatment Pilot Test**

LADWP will be studying the effectiveness of biological treatment on removal of VOCs contaminants from the Tujunga Wellfield groundwater. Biological treatment is a proven technology for removal of perchlorate and nitrate contaminants from groundwater which are also present in the Tujunga Wellfield groundwater. If biological treatment can also effectively remove VOCs from the groundwater, LADWP can significantly reduce the capital as well as future operations and maintenance costs associated with cleanup and removal of contaminants from the Tujunga Wellfield groundwater.

### **Pilot Test of Advance and Emerging Groundwater Treatment Technologies**

LADWP is investigating the utilization of other advance and/or emerging

groundwater treatment technologies for removal of VOCs and perchlorate for possible pilot study(ies) at the Rinaldi-Toluca Wellfield within the next few years.

### 6.3 Sylmar and Eagle Rock Basins

---

The Sylmar Basin has provided slightly over 4 percent of the City's local groundwater ranging from 576 AF to 4,046 AF from FY 2005/06 through FY 2009/10. The Sylmar Basin, in the northern part of ULARA, consists of 5,600 acres and comprises 4.6 percent of the ULARA area. It is bounded on the north and east by the San Gabriel Mountains; on the west by a topographic divide in the valley fill between the Mission Hills and the San Gabriel Mountains; and on the south by the Little Tujunga syncline, which separates it from the SFB. (ULARA Watermaster Service Report, Water Year 2008/09) LADWP originally had a total of 3 production wells installed in the Sylmar Basin between 1961 and 1977. One of these wells was removed from service and is no longer utilized. The remaining wells have the capacity to pump 5 cfs.

The Eagle Rock Basin is the smallest of the four basins. It is located in the extreme southeast corner of ULARA. It consists of 800 acres and comprises 0.6 percent of the total ULARA area. LADWP is not pumping in the Eagle Rock Basin currently. The safe yield of Eagle Rock Basin is derived from imported water delivered by LADWP. There is no measurable native safe yield. LADWP has the right to extract the entire safe yield of the basin. Currently, the groundwater is being pumped by a private party and LADWP is reimbursed for such pumping in accordance with the San Fernando Judgment.

#### Groundwater Rights

In 1996 upon the recommendation of the Watermaster, the ULARA Administrative

Committee approved a temporary safe yield increase for the Sylmar Basin thus temporarily increasing LADWP's rights from 3,105 AFY to 3,255 AFY for a ten-year period. Per the 1984 Stipulation, the safe yield minus private party overlying rights are to be equally split between LADWP and the City of San Fernando. In 2006, a subsequent evaluation of the safe yield was conducted and completed in accordance with Section 8.2.10 of the 1984 Stipulation. Upon recommendation of the parties, the Court approved a new stipulation further increasing the temporary safe yield of the basin and resulting in a temporary increase in LADWP's rights to 3,405 AFY subject to multiple conditions. Conditions imposed on LADWP and the City of San Fernando include installing groundwater monitoring wells to assist in determining basin outflows. This new stipulation became effective on October 1, 2006 and is set to expire on October 1, 2016.

Stored water credits accumulated in the basin are determined by adding the previous years stored water credit and the extraction right for the previous year together and then subtracting the actual extractions for the previous year. As of October 1, 2009, LADWP has accrued 9,423 AF of stored water credits in the Sylmar Basin. In 2006, the Watermaster recommended LADWP to begin pumping these rights due to the large amount of stored water credits. LADWP has proposed the Mission Wells Improvement Project to initiate pumping the credits and to replace the existing wells that have significantly deteriorated. As proposed, the project consists of constructing a water tank, three wells, and other operational facilities at the Mission Wellfield. Phase 1 was completed in February 2009 and involved replacement of the water tank that was beyond its useful life. Phase 2 is in the planning stages and consists of three new wells with operational facilities and is forecast for completion in August 2014. These new facilities will allow LADWP to pump its current entitlement of 3,405 AFY on an annual basis and draw from its existing stored water credits.



## Water Quality

Groundwater quality issues have occurred in the Sylmar Basin related to TCE contamination at one of the two production wells. The effluent from the wellfield is managed in such a way that the groundwater quality meets or surpasses water quality standards. Primary limitations on pumping are related to the deterioration of pumping facilities and not contamination. However, the Mission Wells Improvement Project as previously discussed, will replace the deteriorated wells and increase production capacity to allow LADWP to pump its annual water rights.

## 6.4 Central Basin

From FY 2005/2006 through FY 2009/10, the Central Basin has provided on average approximately 17 percent of LADWP's local groundwater supply ranging from 11,766 AF to 13,358 AF through wells in two major production fields. The Central Basin Watermaster Service area overlies about 227 square miles of the Central

Basin in the southeastern part of the Los Angeles Coastal Plain in Los Angeles County. The Watermaster Service Area is bounded by the Newport-Inglewood Uplift on the southwest, the Los Angeles-Orange County line on the southeast, and an irregular line that approximately follows Stocker Street, Martin Luther King Boulevard, Alameda Street, Olympic Boulevard, the boundary between the City of Los Angeles and unincorporated East Los Angeles, and the foot of the Merced and Puente Hills on the north. Twenty-three incorporated cities and several unincorporated areas are within the Central Basin Watermaster Service Area. Groundwater within the basin provides a large portion of the water supply needed by overlying residents and industries. In FY 2008/09, there were 140 parties with rights to water within the Central Basin (Central Basin Watermaster Service Report, FY 2009/10).

Two LADWP facilities provide groundwater supplies in the Central Basin, the Manhattan Wells and the 99th Street Wells. The active Manhattan Wells were installed between 1928 and 1974 and have a production capacity of 16.9 cfs. Wells at the 99th Street location were installed between 1974 and 2002 and have a production capacity of 7.4 cfs.



While the 99th Street Wells are newer and have relatively little mechanical or other problems, the Manhattan Wells are much older and have experienced maintenance problems and are approaching the end of their useful life. To restore the City's pumping capacity, LADWP is working on plans to install two new production wells, replace two deteriorated wells, and improve other related facilities at the Manhattan Wells site.

## Groundwater Rights

More than 50 years ago, groundwater overdraft and declining water levels in the Central Basin threatened the area's groundwater supply and caused seawater intrusion in the southern part of the Central Basin. However, timely legal action and adjudication of the water rights halted the overdraft and prevented further damage to the Central Basin. Today, groundwater use in the Central Basin is restricted to the allowed pumping allocations by a 1966 Superior Court Judgment and is monitored by a court-appointed Watermaster, the Department of Water Resources (DWR). Annually, the Watermaster prepares a Watermaster Service Report indicating groundwater extractions, replenishment operations, imported water use, recycled water use, finances of Watermaster services, administration of the water exchange pool, and significant water-related events in the Central Basin.

The City's entitlement in the Central Basin of 15,000 AFY was established in a judgment by the Superior Court of the State of California for the County of Los Angeles through the Central Basin Judgment (Case No. 786,656 –second amended judgment). In addition to its annual entitlement, the Central Basin Judgment allows for carryover of unused water rights up to a maximum total cumulative amount of 20 percent of the purveyor's pumping allocation and also allows for over extraction of an additional 20 percent under emergency situations that would be debited against the purveyor's following year entitlement. The City uses its carryover storage right for

operational flexibility and conjunctive use. LADWP has allowable carryover storage of 3,000 AF into FY 2010/11.

The Central Basin or West Coast Basin Judgements do not permit storing water in the basin for later extraction. Through the assistance of a facilitator, multiple parties with groundwater rights have developed a draft framework to allow conjunctive use groundwater storage in the basins and are seeking amendment of the Judgments to allow groundwater storage. Two separate cases are currently in the Superior Court on the storage framework issue.

## Water Quality

Although the Manhattan and 99<sup>th</sup> Street Well fields in the Central Basin are located only approximately 4 miles apart, there is a large difference in water quality between the facilities. One of the Manhattan Wells currently exceeds the MCL of 5 ppb for TCE. The effluent from the wellfield is managed in such a way that the groundwater quality meets or surpasses water quality standards.

Water from 99<sup>th</sup> Street Wellfield complies with the National Primary Drinking Water Regulations, but requires treatment to comply with the National Secondary Drinking Water Regulations for manganese and iron. These contaminants are not considered to present a risk to human health, but at existing concentrations the contaminants may present taste, color, and odor problems. Corrosion control treatment using zinc orthophosphate as a sequestering agent and sodium hypochlorite to oxidize manganese has been in place at the wellfield for twenty years. Hydrogen sulfide is also present but not an imminent threat to the reliability of this well supply when chlorinated. In 2002, two new wells were drilled and placed into operation. During the first several months of operation of the new wells, numerous color complaints were received from customers. Adjustments in the treatment process were made which improved water quality.

## 6.5 West Coast Basin

---

LADWP has not been able to pump its water entitlement from the West Coast Basin since 1980 due to localized groundwater contamination issues and deterioration of the wells at the Lomita Wellfield. The West Coast Basin underlies 160 square miles in the southwestern part of the Los Angeles Coastal Plain in Los Angeles County. The West Coast Basin is bounded on the west by Santa Monica Bay, on the north by Ballona Escarpment, on the east by the Newport-Inglewood Uplift, and on the south by San Pedro Bay and the Palos Verdes Hills. Twenty incorporated cities and several unincorporated areas overlie the West Coast Basin (West Coast Basin Watermaster Service Report, FY 2009/10).

### Groundwater Rights

In 1945, when intrusion of sea water caused by declining water levels threatened the quality of the groundwater supply, legal action was taken to halt the overdraft and prevent further damage to the West Coast Basin. In 1955, the Superior Court of Los Angeles County appointed the DWR as the Watermaster to administer an Interim Agreement, and in 1961, the Court retained the DWR as the Watermaster of the Final West Coast Basin Judgment (Case No. 506,806 –amended judgment). Similar to the Central Coast Basin, an annual Watermaster Service Report is prepared. The West Coast Basin Judgment provided the City with a right to 1,503 AFY of groundwater.

### Water Quality

Groundwater quality problems in the West Coast Basin were previously related to high levels of total dissolved solids and chlorides. LADWP halted operations in the basin in September of 1980 with closure of the Lomita Well Field, and intends to study the feasibility and cost of restoring groundwater pumping.

## 6.6 Unadjudicated Basins

---

The Central and West Los Angeles Areas include the Hollywood Basin and Santa Monica Basin. Both Basins are unadjudicated. In the past, LADWP studied the potential for utilizing these basins for increased groundwater supply. It was determined that developing groundwater was not recommended due to water quality and cost considerations. However, LADWP intends to revisit the potential for increased groundwater production from these two basins. It is anticipated that available supplies remain low and water quality issues remain, but as the cost of imported water increases, it is prudent to reconsider this local water source.

## 6.7 Water Quality Goals and Management

---

The groundwater management efforts that LADWP has undertaken have resulted in all groundwater delivered to customers meeting or exceeding all water quality regulations. As part of its regulatory compliance efforts, LADWP works with the CDPH to perform water quality testing on production and monitoring wells.

### Groundwater Monitoring

LADWP conducts extensive field and laboratory tests throughout the year for hundreds of different chemicals, such as arsenic, chromium, lead, and disinfection by-products, to ensure that they are will within the safe levels before we serve the water to our customers.

Every well that is pumped to supply water to the City is actively monitored by LADWP as required by CDPH. LADWP's groundwater monitoring program is comprised of several distinct components, including monitoring of metals, coliform bacteria, inorganics, volatile organic

## Exhibit 6D Operating Limits of Regulated Compounds

Compound	State of California Limit	LADWP Operational Goals	LADWP Added Safety Margin
Trichloroethylene (TCE)	5 ppb	3 ppb	40%
Perchloroethylene (PCE)	5 ppb	3 ppb	40%
Nitrate (NO <sub>3</sub> )	45 ppm	30 ppm	33%
Perchlorate (ClO <sub>4</sub> )	6 ppb	4 ppb	33%
Total Chromium	50 ppb	30 ppb	40%

compounds (VOCs) and unregulated compounds such as vanadium, boron, and perchlorate. The frequency and level of monitoring (i.e., annually, quarterly, or monthly), depending on the level of contamination found in each well.

Monitoring for all contaminants is performed at entry points into the distribution system in close proximity to where the water is being pumped from the wells. If water quality problems are detected, the well source is immediately isolated and retested.

### Operating Goals

LADWP has established operating goals for TCE, PCE, nitrates, perchlorate, and total chromium that are more stringent than the maximum contaminant levels (MCLs) permitted by Federal or State regulations. These stricter operational goals provide an additional safety margin from these contaminants for City customers. Exhibit 6D summarizes these water quality goals and compares them with the State-regulated requirements, which are generally more stringent than Federal requirements.

TCE and PCE compounds are commonly used in industries requiring metal degreasing. PCE is also used in dry cleaning and automotive repair industries.

Nitrate is a concern because of its acute effect of impeding the uptake of oxygen to the blood. Infants (who are in the earliest stages of development) are most sensitive

to the effects of nitrates. The current standard for nitrate is 45 parts per million (ppm). A single exceedence of the nitrate standard is classified as an acute violation requiring immediate public notification. Treatment for nitrates may eventually become necessary for affected City groundwater supplies.

In October 2007, a MCL was adopted for perchlorate of 6 ppb. Perchlorate is an inorganic compound that is most commonly used in the manufacture of rocket fuels, munitions, and fireworks. In addition to its detection in groundwater, the compound has also been detected in Colorado River Aqueduct water.

### Managing Emerging Contaminants of Concern

LADWP addresses emerging contaminants on many levels: 1) by encouraging the development of standardized testing to enable early detection and supporting the regulatory framework by providing early occurrence data, 2) by advocating good science and a balanced approach to risk assessment, 3) by seeking to gain a risk perspective with other existing contaminants to manage the emerging contaminants in the absence of regulations, 4) by supporting early interpretation of emerging contaminants in collaboration with research and regulatory agencies, and 5) by supporting the research to develop cost-effective treatment for the removal and management of these emerging contaminants.

An example of how LADWP addresses an emerging contaminant is chromium VI (otherwise known as hexavalent chromium). Hexavalent chromium does not have an enforceable drinking water standard at this time. However, hexavalent chromium is included in the State total chromium standard of 50 ppb. CDPH is expected to establish drinking water standards for the compound in the near future. Chromium is a heavy metal that has been used in industry for various purposes including electroplating, leather tanning, and textile manufacturing, as well as controlling biofilm formation in cooling towers. LADWP began low level monitoring of hexavalent chromium long before monitoring was required by regulators. LADWP supported new health-effects research needed to support risk assessment, and advocated a balanced approach to risk management. LADWP funded research to develop new treatment technologies to reduce hexavalent chromium detection levels.

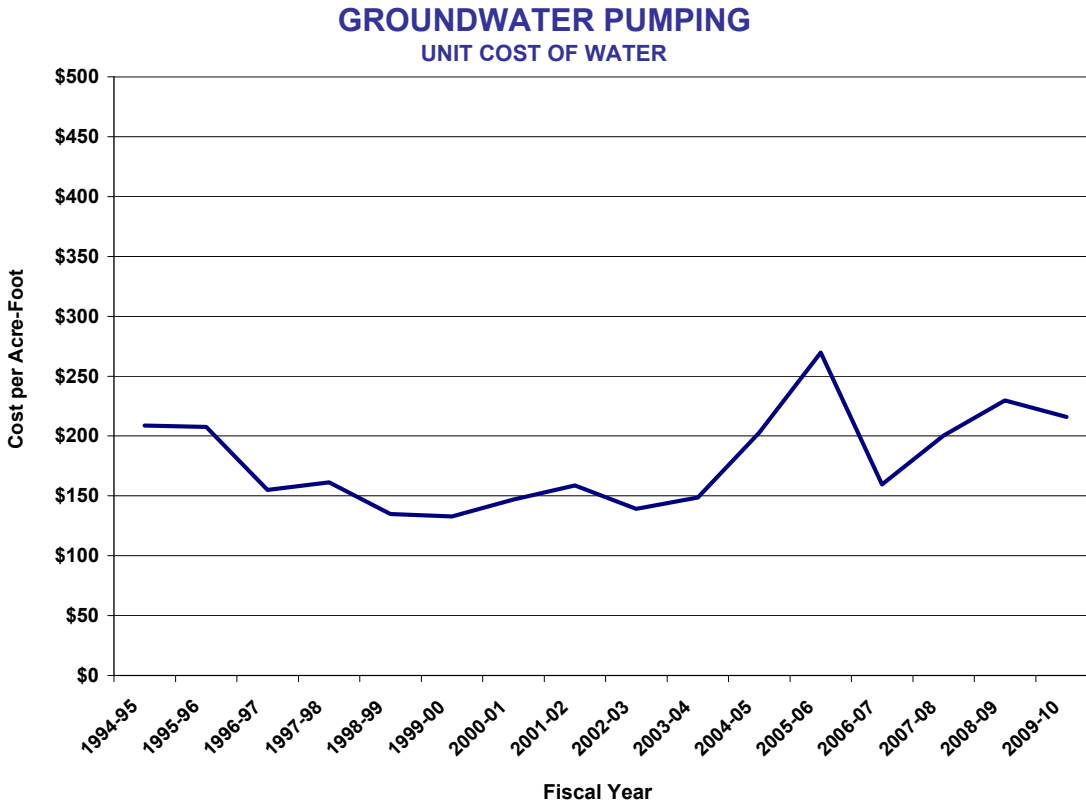
Most recent among emerging contaminants are pharmaceutically active compounds and personal care products that are finding their way into rivers,

lakes, and waterways from urbanized areas. There are concerns about the occurrence and effects of endocrine disruptors, hormone-shifting compounds, and pharmaceuticals. Technology now allows the detection of compounds down to the parts per trillion levels, thus some of these compounds are now being detected. The risk assessment field is finding it difficult to keep pace with advances in analytical detection technology. The question of these contaminants posing a health risk at low levels needs more investigation. LADWP will continue to proactively address emerging contaminants through early monitoring and utilization of a balanced approach to risk management.

LADWP will be incorporating appropriate treatment processes into future groundwater treatment facilities. LADWP has and will continue to solicit input from stakeholders to properly plan and develop processes for removal and treatment of emerging contaminants. LADWP's Recycled Water Advisory Group (RWAG) is an example of ongoing efforts to solicit input.



**Exhibit 6E**  
**Historical Cost of Groundwater Pumping**



**Exhibit 6F**  
**Annual Unit Cost (\$/AF)**

Fiscal Year	2005/06	2006/07	2007/08	2008/09	2009/10
Unit Cost	\$270	\$160	\$200	\$230	\$216

**6.8 Groundwater Pumping Cost**

The costs associated with groundwater pumping are primarily operation and maintenance costs. Therefore, the unit cost of groundwater pumping varies mainly with the quantity of water delivered. Exhibit 6E summarizes the historical unit cost of groundwater pumping.

Exhibit 6F shows the unit cost of groundwater pumping from FY 2005/2006 to FY 2009/2010. The 5-year average was \$215/AF.

**6.9 Groundwater Production Projections**

Historically, with conjunctive use management of groundwater, storing imported water in the groundwater basins during wet and normal years, groundwater production can actually be increased during dry years. LADWP operated its groundwater resources in this manner. On average, LADWP pumped its adjudicated right of approximately 107,000 AFY, but in dry years LADWP could pump larger quantities of groundwater. For the purposes of an average, single-dry, and multi-dry year analysis, after the implementation of groundwater treatment for the SFB and completing the construction of new wells in the Sylmar and Central Basins, 110,405



AFY is assumed to be the City's local groundwater production in 2035. After completion of groundwater treatment for the SFB, if successive dry years occur, LADWP would likely pump at greater-than-average levels for the first few dry years, then start pumping at lower levels in order to prevent groundwater overdraft. LADWP would then replenish the groundwater in wet or normal years following the successive dry period. Exhibit 6G provides groundwater pumping projections by basin between 2010 and 2035 for average, single-dry, and multi-year dry weather conditions in five-year increments.

Not included in the figure below is increased groundwater pumping due to groundwater replenishment of advanced treated wastewater, as well as enhanced stormwater recharge. This Urban Water Management Plan projects increased groundwater pumping through groundwater replenishment of advanced treated wastewater of 15,000 AFY, and increased groundwater pumping through enhanced stormwater recharge of and additional 15,000 AFY, both by 2035.

**Exhibit 6G**  
**Groundwater Production 2010 to 2035 for Average, Single-Dry, and Multi-Year Dry Weather Conditions**

Basin	FY 2009/10	FY 2014/15	FY 2019/20	FY 2024/25	FY 2029/30	FY 2034/35
<b>AFY</b>						
San Fernando	62,218	21,000	76,800	92,000	92,000	92,000
Sylmar	2,998	4,500	4,500	4,500	4,500	3,405
Central	11,766	15,000	15,000	15,000	15,000	15,000
Total	76,982	40,500	96,300	111,500	111,500	110,405

- 2015 San Fernando pumping levels are decreased due to anticipated well contamination from plume migration.
- Assumes existing annual rights to 87,000 AFY in SFB will remain unchanged. The groundwater treatment facilities are expected to be in operation in FY 2020/21. Storage credit of 5,000 AFY will be used to maximize the pumping thereafter.
- Sylmar Basin production temporarily increases to 4,500 AFY to avoid the expiration of stored water credits then return back to the entitlement of 3,405 AFY in FY 2030/31.

## Chapter Seven

# Watershed Management

### 7.0 Overview

---

This Urban Water Management Plan projects that additional stormwater capture projects will provide for increased groundwater pumping rights in the San Fernando Basin of 15,000 AFY. Stormwater capture projects will also provide 10,000 AFY of additional water conservation from capture and reuse solutions such as rain barrels and cisterns, for a total of 25,000 AFY by fiscal year ending 2035. The Stormwater Capture Master Plan (refer to Section 7.3 below) will comprehensively evaluate stormwater capture potential within the City.

Stormwater runoff from urban areas is an underutilized resource. Within the City of Los Angeles, the majority of stormwater runoff is directed to storm drains and ultimately channeled into the ocean. Unused stormwater reaching the ocean carries with it many pollutants that are harmful to marine life. In addition, local groundwater aquifers that should be replenished by stormwater are receiving less recharge than in the past due to increased urbanization. Urbanization has increased the City's hardscape, which has resulted in less infiltration of stormwater and a decline in groundwater elevations.

In addition, development has encroached onto waterway floodplains requiring the channelization of these waterways that once recharged the groundwater aquifers with large volumes of stormwater runoff.

When the floodplains were undergoing rapid development, LADWP and the Los Angeles County Flood Control District (LACFCD) reserved several parcels of land for use as spreading facilities. These facilities are adjacent to some of the largest tributaries of the Los Angeles River, and the Pacoima and Tujunga Washes.

During average and below average years, these spreading facilities are very effective at capturing a large portion of the stormwater flowing down the tributaries. However they are incapable of capturing a significant portion of the flows during wet and extremely wet years. Weather patterns in Los Angeles are highly variable, with many periods of dry years and wet years. Some climate studies predict that these patterns may become more extreme in the future.

Furthermore, a significant portion of the watershed is not located adjacent to large tributaries and therefore, cannot be served by existing spreading facilities. These areas are the urbanized low-lying flatlands that also produce stormwater, therefore a strategy to create and implement distributed stormwater infiltration solutions is needed. These distributed solutions include widespread, smaller projects at the neighborhood scale and landscape changes at the individual parcel scale.

With increased attention being placed on stormwater capture, other challenging conditions beyond imperviousness and climate patterns have been identified.



These include antiquated spreading facilities, landfills adjacent to spreading facilities, floodplain encroachment, substructures, and other man-made conditions that limit the ability to capture stormwater for later use. Some conditions such as the antiquated delivery systems at the spreading facilities can easily be retrofitted with new gates and telemetry. Other conditions such as the presence of large sanitary landfills adjacent to spreading facilities, are more difficult to rectify.

In January 2008, LADWP created the Watershed Management Group which is responsible for developing and managing the water system's involvement in emerging issues associated with local and regional stormwater capture. The Watershed Management Group coordinates activities with other agencies, departments, stakeholders and community groups for the purpose of planning and developing projects and initiatives to improve stormwater

management within the City. The Group's primary goal is to increase stormwater capture by enhancing existing centralized stormwater capture facilities and promoting distributed stormwater infiltration systems to achieve the City's long-term strategy of enhancing local stormwater capture. While working to increase stormwater capture for improving long-term groundwater reliability, other watershed benefits can be achieved including increased water conservation, improved water quality, open space enhancements, and flood control.

Additionally, the City is investigating recharge of the San Fernando Basin (SFB) with advanced treated recycled water. A more in-depth discussion of efforts to maximize groundwater recharge with advanced treated recycled water is provided in Chapter 4, Recycled Water.



## 7.1 Importance of Watershed Management to Groundwater Supplies

Managing native stormwater is a necessary step towards maintaining groundwater elevations in the underlying groundwater basin. Urbanization and its associated increase in impervious surfaces has altered the ability of groundwater basins to naturally replenish pumped groundwater. Stormwater systems in the City were designed primarily for flood control to convey stormwater runoff to the Pacific Ocean as quickly as possible, therefore minimizing the potential for flooding or damage to structures while maximizing land available for development. Within LADWP's service area, the SFB is the most amenable to regional stormwater capture and recharge through spreading basins because of its predominantly sandy soils. However, stormwater that once percolated into the groundwater in the underlying SFB is now being channeled across impervious surfaces then through concrete-lined canals or conduits to areas outside of the San Fernando Valley.

The essential task of watershed management is to retain as much stormwater runoff as possible for groundwater recharge. Groundwater recharge is the process of increasing

an aquifer's water content through percolation of surface water. This occurs in the SFB primarily with captured stormwater but also with imported water. Groundwater recharge is essential to maintain groundwater supplies, address the overall long-term decrease in stored groundwater within the SFB, and ensure the long-term water supply reliability of the SFB. Furthermore, increasing groundwater recharge and improving groundwater levels in the SFB could potentially lead to larger pumping rights for LADWP in the future.

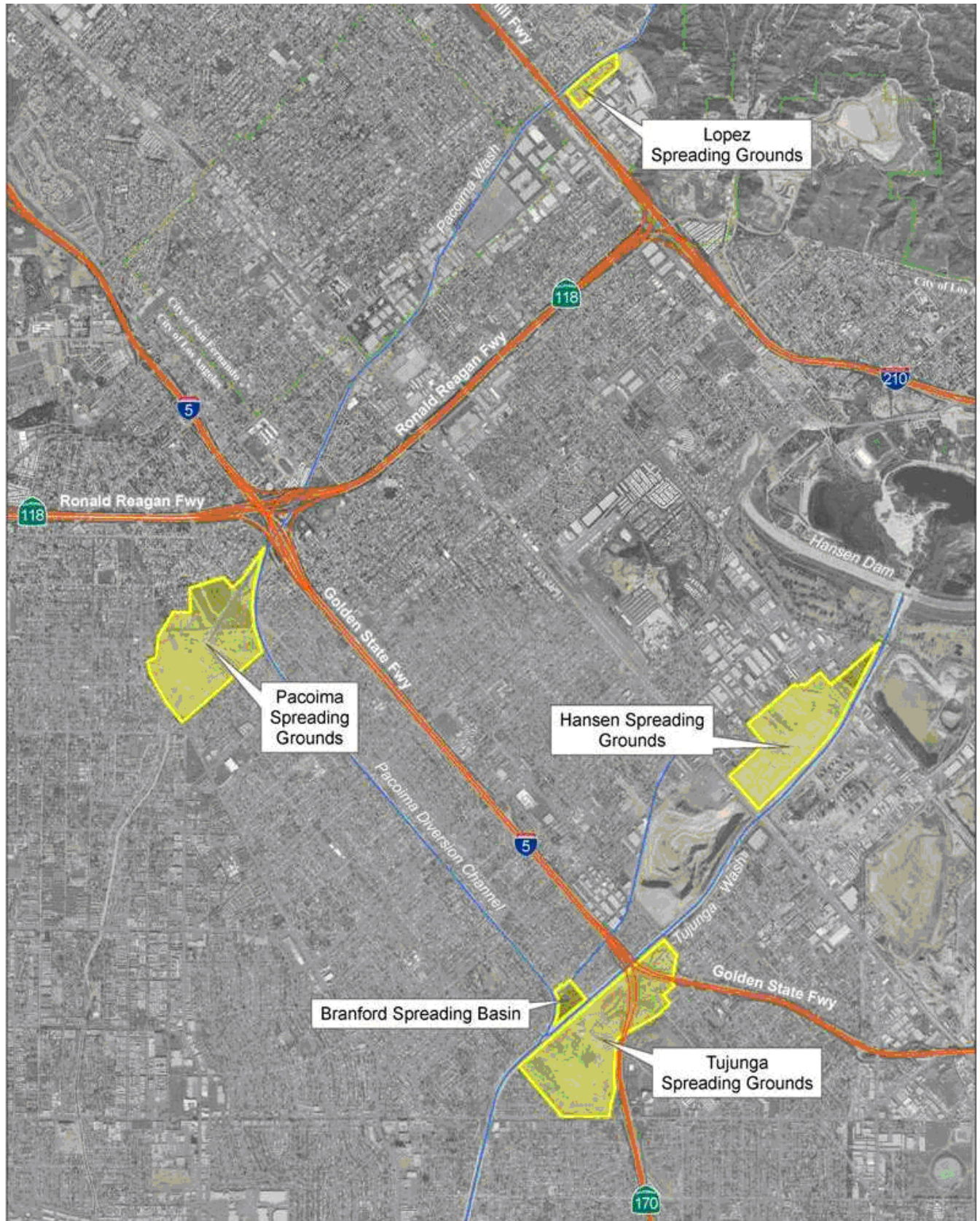
During storm events, large portions of stormwater are captured with existing facilities for spreading purposes. LADWP coordinates these activities with the LACFCD to effectively recharge the SFB through the spreading of native stormwater. Flood control facilities are the primary means to divert native runoff into the spreading ground facilities listed and mapped on Exhibits 7A and 7B. LACFCD oversees operations at the Branford, Hansen, Lopez, and Pacoima Spreading Grounds. The Tujunga Spreading Grounds are operated by LACFCD in partnership with LADWP. LADWP has the ability to spread imported supplies at the Tujunga Spreading Grounds and the Pacoima Spreading Grounds for storage in the SFB, but LADWP has not utilized imported water for groundwater recharge since 1998.

### Exhibit 7A SFB Spreading Grounds Operations Data

Facility	Location	Annual Spreading (AF)	
		Average <sup>1</sup>	Historic High
Branford	Mission Hills, CA	549	2,142
Hansen	Sun Valley, CA	13,834	35,192
Lopez	Lake View Terrace, CA	527	1,735
Pacoima	Pacoima, CA	6,453	22,972
Tujunga	Sun Valley, CA	4,419	21,115
	Total	25,782	83,156

1. Historic average through water year ending September 2009.

**Exhibit 7B**  
**Spreading Ground Facility Locations**



## 7.2 Additional Benefits of Watershed Management

---

Watershed management provides additional important benefits to the City of Los Angeles, including surface water quality improvements, water conservation, open space enhancements, and flood control.

Water quality improvements are necessary because stormwater runoff is a conveyance mechanism that transports pollutants from the watershed into waterways and ultimately the Pacific Ocean. Pollutants include, but are not limited to, bacteria, oils, grease, trash, and heavy metals. The City must also comply with adopted Total Maximum Daily Loads (TMDLs) for pollutants. TMDLs set maximum limits for a specific pollutant that can be discharged to a water body without causing the water body to become impaired or limiting certain uses, such as water body contact during recreation. In 2008, the Los Angeles Board of Public Works adopted the Water Quality Compliance Master Plan for Urban Runoff (WQCMPUR). This 20-year plan provides a strategy for cleaning stormwater and runoff to protect the City's waterways and the Pacific Ocean. Capturing stormwater runoff for groundwater recharge removes a portion of the pollutant conveyance mechanism which reduces downstream pollution and thereby assists the City with water quality compliance and improving the overall health of its waterways.

Water conservation is achieved by enhancing the capture and management of localized runoff for local uses. Centralized and distributed mechanisms that provide for water conservation include spreading grounds, rain barrels, and residential cisterns.

Open space enhancement is an added benefit of groundwater recharge projects, which typically provide additional open space areas that may include passive and/or active recreation, educational opportunities, and habitat restoration.

Most projects involve increasing vegetation and recreational amenities to create opportunities for wildlife habitat and a recreational/educational resource for the local community. Additionally, open space enhancements assist the City in improving the overall quality of life for residents.

Flood control benefits are achieved when additional storage capacity is added to the storm drain system. Groundwater recharge projects reduce potential flooding by diverting a portion of storm flows into recharge areas, thereby increasing the overall capacity of the storm drain system.

## 7.3 Stormwater Capture Master Plan

---

The Stormwater Capture Master Plan (Stormwater Plan) will investigate potential strategies for advancement of stormwater and watershed management in the City. The Stormwater Plan will be used to guide decision makers in the City when making decisions affecting how the City will develop both centralized and distributed stormwater capture goals. The Stormwater Plan will include evaluation of existing stormwater capture facilities and projects, quantify the maximum stormwater capture potential, develop feasible stormwater capture alternatives (i.e., projects, programs, potential policies, etc.), and provide potential strategies to increase stormwater capture. The Stormwater Plan will also evaluate the multi-beneficial aspects of increasing stormwater capture, including potential open space alternatives, improved downstream water quality, and peak flow attenuation in downstream channels, creeks, and streams such as the Los Angeles River.

The Stormwater Plan will recommend stormwater capture projects, programs, policies, and incentives for the City of Los Angeles.

Benefits of the Stormwater Plan include:

- Investigation of stormwater capture models such as the Groundwater Augmentation Model and the Watershed Management Modeling System to identify maximum potential groundwater recharge.
- Increased water conservation.
- Improved water quality .
- Reduced peak flow in the Los Angeles River.
- Project partners and supporters include:
  - City of Los Angeles Department of Water and Power
  - City of Los Angeles Department of Public Works
  - County of Los Angeles Department of Public Works
  - TreePeople, Inc.

A Request for Proposal for the Stormwater Plan was released on February 24, 2011. The contract is anticipated to be awarded by the last quarter of 2011, and completion of the Stormwater Plan will take approximately 24 months.

## **7.4 TreePeople – Memorandum of Agreement**

The Memorandum of Agreement (MOA) with TreePeople has been forged to facilitate a high-level of collaboration between LADWP and TreePeople with the aim of fostering a more sustainable Los Angeles. The partnership it outlines leverages TreePeople’s experience in public education and agency integration to further the long-term sustainability objectives of LADWP. Specifically, LADWP

and TreePeople are working together to research opportunities within LADWP’s facilities and operations for widespread groundwater recharge. This research includes an educational component wherein LADWP and TreePeople learn about each other’s initiatives and core business. Ultimately, this exchange of ideas will help the two partners develop concepts for projects that will increase stormwater capture for groundwater recharge.

LADWP was an early sponsor of the TreePeople Trans-agency Resources for Environmental and Economic Sustainability (T.R.E.E.S.) Project, during which time TreePeople developed best management practices for capturing, cleaning and using stormwater; published the handbook *Second Nature*; created a computerized cost-benefit model; and facilitated a number of design workshops for public agencies. TreePeople has also been integral to the construction and management of three demonstration sites -- a single-family home (Hall House) retrofitted to capture all the rainwater onsite, and two elementary schools (Broadous and Open Charter) that feature strategic landscaping and a cistern or underground infiltrators. LADWP has supported public tours and educational materials for Hall House, and is a key partner in the school projects which were partially funded through the Cool Schools and Sustainable Schools programs.

The overlap between the objectives of LADWP and those of TreePeople is notable in the Tujunga Wash and Sun Valley watersheds, where both have been especially active. Stakeholder processes in which the two have worked successfully to further mutual goals include the City’s Integrated Resources Plan, the Greater Los Angeles County Integrated Regional Water Management Plan, and development of the objectives of the California Urban Water Conservation Council.

## 7.5 Centralized Stormwater Capture Projects

Existing stormwater capture facilities are inadequate for capturing runoff during very wet years. Weather patterns vary dramatically in Los Angeles with very wet years and very dry years. Therefore, new projects are necessary to expand the capability to capture a larger portion of stormwater flows during wet years. LADWP is working proactively in close partnership with LACFCD on multiple stormwater projects, as listed in Exhibit 7C. These projects will increase centralized stormwater recharge capacity by approximately 26,000 AFY in the SFB, raising groundwater levels and ensuring the future water supply

reliability of the SFB. These projects are designed to maximize groundwater recharge into the SFB by increasing the total average recharge to approximately 51,700 AFY.

Multiple opportunities exist to develop new recharge projects and improve existing recharge projects in the SFB. LADWP, in collaboration with LACFCD has supported and contributed resources toward the design, construction, and implementation of a variety of projects to increase groundwater recharge of the SFB. Additionally, multiple agreements between LADWP and LACFCD have been approved to facilitate the preparation of recharge studies, design work, and construction of projects in the SFB for groundwater recharge, flood protection, and other benefits.

### Exhibit 7C Planned Centralized Stormwater Capture Programs

Project	Current Annual Recharge (AFY)	Increased Annual Capture/ Recharge (AFY)	Expected Annual Recharge (AFY)	Estimated Project Completion	Total Project Cost (millions)	LADWP Share (millions)
Sheldon-Arleta Gas Collection System	-	4,000 <sup>(1)</sup>	-	Complete Nov 2009	\$8.20	\$6.30
Big Tujunga Dam Rehabilitation <sup>(3)</sup>	-	4,500	-	July 2011	\$105.70	\$9.00
Hansen Spreading Grounds Upgrade	13,834	1,200	17,284 <sup>(2)</sup>	Dec 2011	\$9.30	\$4.80
Tujunga Spreading Grounds Upgrade	4,419	8,000	18,669 <sup>(4)</sup>	2015	\$24.00	\$24.00
Pacoima Spreading Grounds Upgrade	6,453	2,000	8,453	2015	\$32.00	\$16.00
Lopez Spreading Grounds Upgrade	527	750	1,277	2016	\$8.00	\$4.00
Strathern Wetlands Park	-	900	900 <sup>(5)</sup>	2016	\$46.00	\$4.00
Hansen Dam Water Conservation	-	3,400	3,400	2017	\$5.00	\$2.50
Valley Generating Station Stormwater Capture	-	700	700	2018	\$9.70	\$9.70
Branford Spreading Basin Upgrade	549	500	1,049	2018	\$4.00	\$2.00
<b>Total Estimated Yield</b>	<b>25,782</b>	<b>25,950</b>	<b>51,732</b>		<b>\$251.90</b>	<b>\$82.30</b>
Total Expenditure-to-date						\$18.60
Total Expenditure Remaining						\$63.70

1. This will allow increased collection of 4,000 AFY at Tujunga Spreading Grounds.
2. Includes 1/2 benefits from Big Tujunga Dam Rehabilitation Project.
3. No recharge occurs at the facility. All additional capture has been divided between Hansen & Tujunga Spreading Grounds.
4. Including benefits from Sheldon-Arleta Project and 1/2 benefits from Big Tujunga Dam Rehabilitation Project.
5. To be recharged at Sun Valley Park.



**Sheldon-Arleta Methane Gas Collection Project.** In 1998, a task force comprised of representatives from LADWP, other City departments (Bureau of Sanitation (BOS), Bureau of Engineering, and Environmental Affairs) and the Upper Los Angeles River Area Watermaster was formed to review the issues surrounding the recharge of groundwater through spreading at the Tujunga Spreading Grounds. The objective of this Task Force was to maximize water spreading at the Tujunga Spreading Grounds without causing off-site landfill gas migration. An outcome of the Task Force was the Sheldon-Arleta Methane Gas Collection Project. The project is designed to restore the original Tujunga Spreading Grounds capacity of 250 cubic feet per second (cfs) with the potential for future enhancement by bringing the Tujunga Spreading Basins closest to the Sheldon-Arleta landfill back online. The Tujunga Spreading Grounds are located adjacent to the closed Sheldon-Arleta Landfill. During spreading operations, water displaces air from the ground potentially increasing migration of methane gas generated by the landfill. In the past, elevated levels of methane gas have been detected in the surrounding communities. Therefore, restrictions were enacted curtailing spreading operations to 20 percent of their original capacity. This project is a joint effort between LADWP and BOS to replace the methane gas collection system within the landfill and

thereby contain methane gas onsite. The project is being implemented by LADWP through LABOS's Proposition "O" Clean Water Bond program. Proposition "O" funded approximately \$3 million of the \$9 million cost. Construction began in 2007 and was completed in November 2009.

**Big Tujunga Dam – San Fernando Groundwater Enhancement Project.**

LADWP and LACFCD approved Cooperative Agreement No. 47717 on September 18, 2007 for the Big Tujunga Dam –San Fernando Groundwater Enhancement Project. This Project will increase stormwater capture and provide other benefits including improvements in flood prevention and environmental enhancement through seismically retrofitting the dam and spillway. Annual stormwater capture will increase by 4,500 AFY for a total capture amount of 6,000 AFY. The project is integrated with the following projects in this section: Hansen Spreading Grounds Enhancement Project, Tujunga Spreading Grounds Enhancement Project, and the Sheldon-Arleta Methane Gas Collection Project. Both the Greater Los Angeles County Integrated Regional Watershed Management Plan and the Tujunga/Pacoima Watershed Plan are being incorporated into the Project. LADWP is contributing \$9 million of the \$105 million project cost. Construction of the project is in progress with an anticipated completion date by July 2011.

### **Hansen Spreading Grounds**

**Enhancement Project.** The Hansen Spreading Grounds is a 120 acre parcel located adjacent to the Tujunga Wash Channel downstream from the Hansen Dam. Under Cooperative Agreement No. 47739, the LACFCD and LADWP propose to modernize the facility to increase intake and storage capacity thereby improving groundwater recharge, flood protection and water quality while providing recreational benefits and native habitat improvements. To accomplish the goals of the project, a phased approach is being proposed. Phase 1A will deepen and reconfigure the existing basins; Phase 1B will improve the intake capacity by replacing a radial gate with a new rubber dam and telemetry system; and Phase 2 will develop other compatible uses such as recreational trails and native habitat for the community. Estimated recharge is 17,284 AFY, and estimated cost of this project is \$10 million of which LADWP will fund \$5 million. The Phase 1A reconstruction of the spreading grounds was completed in December 2009 and the Phase 1B intake structure will be completed in December 2011.

### **Tujunga Spreading Grounds**

**Enhancement Project.** The Tujunga Spreading Grounds Enhancement Project is designed to increase average annual stormwater capture by 8,000 AFY through relocating and automating the current intake structure on the Tujunga Wash, installation of an automated intake structure on the Pacoima Wash, and reconfiguration of the Tujunga Spreading Basins. Other multiple benefits include habitat improvements, passive recreation, educational opportunities, flood protection, and water quality improvements. Owned by LADWP, the Tujunga Spreading Grounds are operated by LACFCD in conjunction with other facilities along the Tujunga and Pacoima Wash Channels. Construction is expected to begin in 2012.

### **Valley Generating Station Stormwater**

**Capture Project.** LADWP is leading efforts to capture and infiltrate stormwater from the Valley Generating Station, from adjacent streets, and from the Tujunga Wash Channel. Phase 1 will capture and infiltrate all stormwater from the Valley Generating Station. Phase 2 will divert water mainly from the Hansen



Spreading Grounds for infiltration at the abandoned gravel pit at the generating station. Total stormwater capture is estimated at 700 AFY. Project designs are expected to be completed at the end of 2013.

**Pacoima Spreading Grounds Enhancement Project.** LADWP in conjunction with LACFCD is proposing to upgrade the Pacoima Spreading Grounds by improving the intake and stormwater storage capacity. Annual average stormwater capture is expected to increase by approximately 2,000 AFY with completion of the project. Other project benefits include flood protection, water quality improvements, and passive recreation. The final concept report and design has an expected completion date by the end of 2012.

**Lopez Spreading Grounds Enhancement Project.** The Lopez Spreading Grounds Enhancement Project involves deepening the existing Lopez Spreading Grounds and improving the intake and delivery system. LACFCD is the lead agency for the project. Additional groundwater recharge to the SFB of approximately 750 AFY is expected from the project. Project designs are anticipated to begin in 2013.

**Strathern Wetlands Park Project.** The Strathern Wetlands Park Project involves the conversion of a 45-acre gravel pit into a multipurpose facility for flood protection, stormwater retention, treatment, groundwater recharge, habitat restoration, and recreation. Estimated stormwater capture is approximately 900 AFY. Proposition "O" funding of \$17.8 million has been approved for acquisition of the site. LACFCD purchased the land and project planning is underway. Designs are expected in 2012, and construction is expected to occur in two phases from 2013 to 2016.

**Hansen Dam Water Conservation Project.** In 1999 the U.S. Army Corps of Engineers completed a feasibility study to examine operational changes and facility improvements at the Hansen Dam as part of a cost-shared study with LACFCD.

**Pacoima Dam Reservoir Sediment Removal Project.** The Pacoima Dam Reservoir Sediment Removal Project involves removing sediment from behind Pacoima Dam to increase storage volume. The sediment build-up behind the dam has decreased the capacity to about 3,300 acre-feet. In the fall of 2009 approximately 80 percent of the Pacoima Dam watershed was burned. This damage will likely increase sediment flow into the reservoir above the estimates provided based on 2005 topography. The project will involve excavating 5 million cubic yards of sediment and increasing the storage volume by 3,000 acre-feet. Increased storage would decrease the number of reservoir spill events and increase the available recharge flow for the Pacoima and Lopez Spreading Grounds. The excavation will extend over 7,000 feet upstream of the existing dam. The project will produce an additional annual water recharge benefit of 670 AFY.

**Branford Spreading Basin Upgrade.** The Branford Spreading Basin Project will remove fine silts from the basin and install new pumps to drain the basin. These pumps could be used to drain the existing facility into the Tujunga Spreading Grounds. The expected additional recharge for this project is approximately 500 AFY.

## 7.6 Distributed Stormwater Capture

---

Throughout the City there are opportunities to capture localized dry and wet weather runoff for local reuse. However, Los Angeles' storm drain systems have historically been designed to protect life and property from flood impacts by quickly redirecting rainfall and runoff from impervious surfaces into the City's storm drain system and ultimately the Pacific Ocean without regard to water quality impacts. The September 2, 2002 Municipal Stormwater National Pollutant Discharge Elimination System Permit



(NPDES Permit No. CAS004001) for the Los Angeles region requires all new development or redevelopment projects to develop and comply with a Standard Urban Stormwater Mitigation Plan (SUSMP) to reduce runoff leaving the project site and to improve the project's water quality impacts.

Recently the City has taken initial steps towards promoting distributed capture and infiltration of runoff through development of a suite of distributed runoff demonstration projects. Distributed stormwater capture (also known as decentralized stormwater capture) is defined as any groundwater recharge system capturing less than 500 AF or any direct stormwater capture system capturing less than 10 AF. In addition, the City is close to adopting a Low Impact Development (LID) ordinance requiring retention of stormwater onsite for new and redevelopment projects which extends beyond SUSMP regulations. The Watershed Management Group is working with the Los Angeles and San Gabriel Rivers Watershed Council (LASGRWC), TreePeople, BOS, Department of Building and Safety, Los Angeles County Department of Public Works (LACDPW), The River Project and others to evaluate and study the impacts of localized stormwater capture and source control within the City.

LADWP is providing various resources for projects that would enhance the City's ability to capture additional dry and wet weather runoff for beneficial use. Both dry and wet weather runoff can be beneficially used. Dry weather runoff occurs in the absence of rainfall while wet weather runoff occurs as a direct result of rainfall. Dry weather runoff is typically related to inefficient irrigation systems, overwatering, and other wasteful outdoor water use practices. Wet weather runoff represents a significantly larger volume of water than dry weather runoff. Exhibit 7G summarizes the potential water yield and average unit cost of the different resources available to increase localized capture and infiltration of runoff.

### **7.6.1 Watershed Council – Water Augmentation Study**

---

The Los Angeles Basin Water Augmentation Study is a long-term research project, initiated in 2000, created to determine the benefits of implementing a broad-based approach to stormwater infiltration within the Los Angeles Region. The study was led by the Los Angeles & San Gabriel Rivers Watershed Council in partnership with local, state, and federal agencies and organizations, with major support from the U.S. Bureau of Reclamation. LADWP assisted in the funding and creation of the study report as part of the Technical Advisory Committee.

While centralized strategies such as spreading basins and dams are reliable and effective methods to capture stormwater, increased urbanization, high land costs, and scarcity of imported water for recharge signal the need to pursue additional stormwater capture methods. Furthermore, centralized stormwater infiltration is unable to capture the entire watershed which leaves a large quantity of additional stormwater to be tapped into. The Los Angeles Basin Water Augmentation Study research has concluded that decentralized strategies (distributed stormwater capture such as rainbarrels & cisterns) would provide a local and reliable supply of water that would not negatively impact groundwater quality. Distributed stormwater capture and infiltration system techniques provide a viable means of augmenting groundwater recharge and reducing the overall cost of treating urban runoff. Based on the findings of this study, the Los Angeles Basin Water Augmentation Study partnership moved forward on a demonstration project in a single family residential home neighborhood in northeast San Fernando Valley to validate the study findings.

## CASE STUDY: Elmer Avenue Neighborhood Retrofit Project

### The Background

Initiated in 2000, the Los Angeles Basin Water Augmentation Study (WAS) is a long-term research project led by the Los Angeles & San Gabriel Rivers Watershed Council in partnership with eight local, state, and federal agencies of which LADWP is an active partner. The study is evaluating the practical potential to improve surface water quality and increase local groundwater supplies through infiltration of urban stormwater runoff.

Based on positive findings of the study, the WAS partnership moved forward with a demonstration project to display an integrated and comprehensive approach to water management by retrofitting a neighborhood with strategies to address water conservation, pollution reduction and treatment, flooding, and habitat restoration. The Elmer Avenue Neighborhood Retrofit Project was chosen after an extensive selection process that evaluated neighborhoods based on more than 80 criteria.

### The Project

The Elmer Avenue Neighborhood Retrofit Project commenced in July 2009 and was completed in June 2010 and cost approximately \$2.5 million. Elmer Avenue receives stormwater runoff from approximately 40 acres of upstream residential area causing flooding in most storms. To address this runoff, the project encompasses improvements to both the public right-of-way as well as the private residences. As such, the project required active interaction and cooperation between the WAS partnership and the residents to work together and come up with a solution for the neighborhood.

### **Public Right-of-Way Improvements:**

#### *Infiltration Gallery-*

A large infiltration gallery was installed underneath the street right-of-way which is estimated to infiltrate 16 acre-feet annually. The gallery is a sub-surface groundwater collection system, shallow in depth, constructed with perforated pipes into which runoff water flows and is then allowed to infiltrate into the ground to recharge the local groundwater basin.



#### *Bioswale-*

The newly installed sidewalks include bio-swales in the parkways to capture and treat stormwater runoff from the local sub-watershed mostly from residential land use. The bioswales are open shallow channels with gently sloped sides and bottoms filled with vegetation and rip rap where stormwater runoff is collected. Bioswales help reduce the flow velocity and treat stormwater runoff by filtering it through the vegetation in the channel, through the subsoil matrix, and/or into the underlying soils. In addition, bioswales trap particulate pollutants (suspended solids and trace metals), promote infiltration and serve as part of the whole stormwater drainage system installed for this project.



### ***Private Residence Improvements:***

Numerous improvements were offered to residents who chose to participate to help reduce runoff as well as exercise better outdoor water conservation such as porous pavers, rain gardens, rain barrels, and drought-tolerant and native landscaping.



### **The Benefits**

The finished project incorporates a mixture of strategies to produce multiple levels of benefits (to the neighborhood but also to the local, regional, and national community whom can take this work as an encouraging model):

- Capture stormwater and dry-weather runoff to prevent flooding and decrease pollution of local rivers and oceans
- Reduce impermeable surfaces and increase groundwater recharge
- Improve neighborhood aesthetics through increased green space and public right-of-way improvements
- Increase community awareness of watershed issues
- Encourage community awareness of water and associated environmental issues.

As a result of the success and positive feedback from citizens for the Elmer Avenue Neighborhood Retrofit Project, a second phase is currently underway at Elmer Avenue to retrofit its alleyway. Such small projects aim to spark large change by showing citizens and other communities that they also can make changes and improve their neighborhoods to be more water-efficient and environmentally friendly.



“By turning our yards into rain gardens and our streets into water recharge facilities, we can ensure clean water for the future. In contrast to a typical urban street, Elmer Avenue now reduces flooding and water pollution, improves water quality, replenishes groundwater supplies, and increases native habitat.”

Nancy Steele, Executive Director  
Los Angeles and San Gabriel Rivers Watershed Council

“This project is a prime example of how homeowners and the city can work together on a project that demonstrates smart watershed management through stormwater capture and water conservation measures that are beautiful and effective”

Edward Belden, Water Programs Manager  
Los Angeles and San Gabriel Rivers Watershed Council

## 7.6.2 Integrated Water Resources Plan Analysis

As part of the City’s Integrated Water Resources Plan, further described in Chapter 10, the City investigated the beneficial reuse of urban runoff for both dry and wet weather conditions.

Integrated Water Resources Plan based on the recycled water demands in Los Angeles and the available dry weather runoff. Based on the data, the model determined which of the recycled water demands could be realistically met through treated runoff. The dry weather runoff available for reuse throughout the City is estimated at 97 mgd (approximately 26,000 million gallons per year). Exhibit 7D identifies the amount of this runoff that could, after treatment, be used to meet the recycled water demands.

### 7.6.2.1 Dry Weather Runoff Options

The beneficial use option for dry weather runoff consists of runoff capture, treatment, and reuse. For dry weather flow, most of the runoff could potentially be diverted directly for beneficial use, particularly during the summer months when demands for non-potable water are high (due to the higher irrigation demands in the summertime). The level of treatment of the runoff before beneficial use would be determined by the ultimate use of the water.

A computer modeling analysis was performed during development of the

### 7.6.2.2 Wet Weather Runoff Options

#### Rain Barrels

Rain barrels are distributed stormwater capture devices used to store rainwater collected from roofs via roof rain gutter systems. Harvested water can be used for outdoor irrigation at a later time. Rain barrels vary in size with a typical rain barrel holding approximately 55 gallons that can be readily installed under any residential roof gutter downspout. Installation of rain barrels at residences

### Exhibit 7D Potential Non-Potable Water Demands Met with Dry Weather Treated Runoff

Service Area	Total Demand Served	
	(AF per year)	(million gallon per year)
Aliso Wash	1,400	460
Canoga	3,250	1,050
Reseda	2,900	950
Tujunga / Burbank	9,050	2,950
LA River Reach 3	1,100	360
Dominguez Channel	8,500	2,770
Compton Creek	1,450	470
Ballona	10,850	3,530
Verdugo Wash	100	30
LA River/Arroyo	9,600	3,130
Total	48,200	15,700

Source: City of Los Angeles Integrated Resources Plan, Facilities Plan, Volume 3: Runoff Management

## CASE STUDY: Ballona Creek Watershed Rainwater Harvesting Pilot Program

Funded by the Safe Neighborhood Parks, Clean Water, Clean Air and Coastal Protection Bond Act of 2000 (Prop 12), a partnership between the Santa Monica Bay Restoration Commission and the California Coastal Conservancy, the City of Los Angeles, Department of Public Works, Bureau of Sanitation, Watershed Protection Division (Stormwater Program) began the City's first free Rainwater Harvesting pilot program in July 2009. The goal of this program is to engage as many property owners as possible by installing one downspout and rainbarrel retrofit per property thereby allowing the maximum number of residences engaged.

Liz Herron, Land Use Chair of Mt. Washington Association, supports rainwater harvesting systems: "Rain barrel systems serve environmental purposes by allowing homeowners to collect the rainwater for personal irrigational purposes. It also reduces the amount of rainwater entering into the streets and ocean. These residential systems are successful programs that save water and prevent pollution."

Designed to conserve potable water and reduce the amount of polluted rainwater that runs untreated into the ocean, the \$1-million pilot plan has enough funds to install 490 residential rain barrels, provide consultation on rain gardens, and provide one custom-made commercial planter box for each of ten businesses. It is estimated to save 584,100 gallons of water each year. The City estimates there are roughly 18 rain events in Los Angeles each year filling each barrel at least once each time.



In a typical year, about 9,600 gallons of water is generated on an average 1,000-square foot residential City roof top. If each of the 400,000 residential parcels in the City were to install a single rain barrel, the City estimates that about 400 million gallons of water would be saved, thereby reducing the demand for water. An evaluation of the program is scheduled for completion in Spring 2011.

The 55-gallon capacity rain barrel was chosen because the weight of 200 pounds is relatively manageable. The rain barrels are also made from food-grade plastic, repurposed from containers in case the harvested rainwater is used to grow food. They are equipped with mesh netting to keep out debris and mosquitoes and connected to the downspouts by a trained rain barrel installation specialist.

Planter boxes that businesses are eligible for will be custom-made to fit the layout and dimensions of the property. The City will be working with each business to make sure they are content with the presentation of the planter box.



The program addresses the City's broad problems of water scarcity and stormwater pollution. Currently outdoor water usage accounts for 1/3 of the average family's overall water consumption. The Rainwater Harvesting program helps to meet the City's water conservation goals by reducing the amount of potable water used for irrigation and other outdoor purposes.

throughout Los Angeles could potentially capture 2,400 AFY assuming 400,000 residences, an annual average rainfall of 15.6 inches, one 55-gallon rain barrel installed per residence, and an average roof area of 500 square feet. If overflow infiltration is provided, and/or greater roof area is utilized, annual rainfall volume captured can be significantly greater.

### **Cisterns**

Cisterns are larger than rain barrels and can range from 100 to 10,000 or more gallons. They store diverted runoff from roof areas and other impervious surfaces. This stored runoff can provide a source of untreated water for gardens and compost, free of most sediment and dissolved salts. Because residential irrigation can account for up to 40 percent of domestic water consumption, water conservation measures such as cisterns can be utilized to reduce demands, especially during hot summer months.

An analysis of the effect of installing cisterns in all single family and multi-family residences in the City was conducted as part of the Integrated Water Resources Plan, which was based on

projected household demands, irrigation needs, and historical rainfall data. The results showed that during a storm event of 0.45 inches, the result of installing 1,000-gallon cisterns at all single-family and multi-family residences in the City would be a maximum capture of approximately 440 million gallons. This provides a substantial amount of water conservation and reduction in potable water demands within the City.

The primary beneficial use of dry and wet weather runoff is to meet irrigation demands. These demands are typically non-existent during rain events and low throughout the rainy season. Therefore, the wet weather runoff would need to be stored until the demand exists. This can be done through a regional and/or a localized approach. A regional approach to seasonal storage could include the use of out-of-service reservoirs for seasonal storage. A localized approach would be to construct distributed underground storage facilities in open spaces, parks, schools, etc. throughout the City.

Exhibit 7E demonstrates a modular storage media that holds the runoff in a honeycomb-like box under the ground.

### **Exhibit 7E Construction of Underground Cistern for Stormwater Capture (Photo courtesy of TreePeople)**



## Exhibit 7F Underground Storage Potential throughout the City

Land Use	Acres (acres)	Potential Storage Volume <sup>1</sup> (million gallons)
Open space	6,000	15,000
Schools (assume only ~ 25 percent suitable land)	1,500	4,000
Alleys	900 count	Unknown
Total	7,500	19,000

Note: 1. Maximum storage potential shown assumes 4.22 million gallons of storage per acre of land. Actual usable volume may be less.

Source: City of Los Angeles Integrated Resources Plan, Facilities Plan, Volume 3: Runoff Management

The storage media has approximately 95 percent voids, so almost all of the storage volume would be filled with water. The maximum depth is 8 feet, which translates to approximately 2.44 million gallons per acre of water storage potential. The containers can also be constructed to be impermeable to prohibit infiltration.

According to studies conducted during the development of the Los Angeles Integrated Water Resources Plan, the City currently has an estimated open space area of 6,000 acres, which includes parks, open space, and vacant lots. School sites are also a potential option for installing modular storage media under playgrounds and athletic fields. The total school area in the City is approximately 6,000 acres. Assuming that only 25 percent of this area has no buildings or other structures, this equals approximately 1,500 acres of potentially suitable land. Additionally, there are approximately 900 abandoned or no longer maintained alleys of various unknown dimensions that could potentially be converted to underground storage facilities. Exhibit 7F summarizes the approximate underground storage potential throughout the City.

The City has the potential to store a considerable volume of wet weather runoff in order to meet the potential future surface water quality regulations if the underground storage options were utilized. This stored water could then be drawn down and beneficially used during the dry weather months.

### Rain Gardens

Rain gardens are another simple form of relatively small scale rainwater harvesting. As gardens or depressions, usually constructed sub-grade, they act as small retention/percolations basins for rainwater collection. Not only do they provide for an attractive landscape, but they are effective in treating and infiltrating stormwater for local groundwater recharge.

While extremely functional, these are basically regular gardens and can be designed to fit well into the surrounding landscape. Many cities and states across the country have extensive rain garden programs, and years of research have gone into their design and performance. Acting as a bio-retention systems, rain gardens treat runoff naturally as it seeps underground. In the case of lowered percolation rates or in hillside developments, rain gardens are typically installed with impermeable liners and supplied with under drains.

Unit cost of rain gardens are similar to that of rain barrels, as the mechanism for collecting water is the same. Cost is dependent upon the form and extent of construction and on the type and quantity landscape used, as well as the associated maintenance. Installation of rain gardens at residences throughout Los Angeles, assuming 400,000 residences, could potentially capture 6,400 AFY assuming an annual average rainfall of 15.6 inches, and an average roof area of 500 square

feet. Under these conditions, assuming a 10-15 year lifespan, the cost of rain gardens varies from \$308-\$5,000 / AF.

### **Neighborhood Recharge**

Neighborhood recharge involves installing recharge facilities in portions of vacant urban lots, abandoned alleys, and City parklands, where the soil is highly permeable. This option involves installing underground storage (such as a honeycomb shaped device shown in Exhibit 7F, but without the lining to allow infiltration). This would allow the runoff to be stored underground, while still maintaining a safe area above ground for human activity. The runoff would be pumped or would flow by gravity to the site where it would be collected temporarily until it is able to infiltrate.

The amount of runoff that could be managed by neighborhood recharge was determined as part of the Los Angeles Integrated Water Resources Plan by assuming that only the east San Fernando Valley area has predominantly permeable soils appropriate for infiltration (though there may be other areas within the City that could be usable for recharge with smaller-scale projects). Based on an analysis by the City's Geographical Information System, the maximum total area available for neighborhood recharge facilities is approximately 831 acres, which includes vacant urban lots, abandoned alleys, and 25 percent of City parklands. Assuming an infiltration rate of 2 feet per day, the maximum runoff that could potentially be managed by recharge facilities would be 550 million gallons per day (mgd).

### **7.6.3 Distributed Stormwater Capture Projects**

As an outgrowth of the Los Angeles Integrated Water Resources Plan, neighborhood recharge concept efforts are moving from the conceptual stage visualized in the Los Angeles Integrated Water

Resources Plan to actual identified projects in the City which infiltrate wet weather runoff as close as possible to the point of origin. A few of the identified projects are highlighted here.

**Whitnall Highway Power Line Easement Stormwater Capture Project.** This project involves the capture, treatment, and infiltration of stormwater from streets in the eastern San Fernando Valley using LADWP's Whitnall Power Line Easement in the lower Sun Valley Watershed. Average annual recharge is estimated at 110 AFY. Additional uses of the project site may include open space and recreational enhancements. Designs are anticipated for completion by the end of 2011.

**Elmer Avenue Neighborhood Retrofit Project.** In December of 2008, the City of Los Angeles partnered with TreePeople and the LASGRWC to retrofit an existing neighborhood in the Sun Valley portion of Los Angeles that is prone to flooding during wet weather events. A combination of Best Management Practices such as vegetated swales, infiltration trenches, rain gardens, rain barrels, native and climate appropriate landscaping, roof gutters, street tree plantings, and aligning driveways to drain to vegetated swales are incorporated into this project. This project was designed to capture and infiltrate the equivalent of a 2-year storm in order to increase groundwater recharge. Project funding was provided by the US Bureau of Reclamation, DWR, LACDPW, MWD, Water Replenishment District of Southern California and LADWP. Construction was completed in June 2010.

**Woodman Avenue Multi-Beneficial Stormwater Capture Project.** LADWP in partnership with the BOS Watershed Protection Division and The River Project, a non-profit organization, are developing the Woodman Avenue Median Retrofit Demonstration Project to capture, treat, and infiltrate stormwater runoff along a portion of Woodman Avenue. The Project will replace the existing median with pre-treatment devices, a vegetated swale, and an underground retention system. Project benefits include reductions in localized flooding, open space enhancements,



groundwater recharge, and native habitat enhancement. The CalFed Watershed Program awarded the project a \$1.6 million grant. Construction is expected to be completed by the end of 2012.

**North Hollywood Alley Retrofit BMP Demonstration Project.** The project's goal is to demonstrate the ability to infiltrate stormwater near the point of origin while increasing groundwater recharge, reducing flooding, and improving water quality. Four segments of alleyways in the San Fernando Valley are proposed to be retrofitted with pervious surfaces and diversion of flows from intersecting streets into these alleyways. Construction began in early 2011.

**Laurel Canyon Parkway Infiltration Swale Project.** Construction of the Laurel Canyon Parkway Infiltration Swale Project will involve construction of an infiltration trench and parkway swale between the street curb and sidewalk near the Tujunga Spreading Grounds in the San Fernando Valley. Stormwater will be collected and infiltrated into the groundwater from the local residential neighborhood. The project is currently in the conceptual stage.

## 7.6.4 Low Impact Development and Best Management Practices

---

LADWP, in conjunction with other City departments, is developing programs to highlight water conservation through Low Impact Development (LID) and installation of BMPs. LID is a stormwater management strategy that has been adopted by many localities across the country over the past several years. It is a stormwater management approach that is designed to reduce runoff of water and pollutants from the site(s) at which they are generated.

The past few decades of stormwater management have resulted in the current

convention of control-and-treatment strategies. They are largely engineered, end-of-pipe practices that have been focused on controlling peak flow rate and suspended solids concentrations. Conventional practices, however, fail to address the widespread and cumulative hydrologic modifications within the watershed that increase stormwater volumes and runoff rates and cause excessive erosion and stream channel degradation.

In general, implementing integrated LID practices into new development and retrofit of existing facilities can result in enhanced environmental performance while at the same time reducing development costs when compared to traditional stormwater management approaches.

According to the U.S. Environmental Protection Agency, infrastructure costs associated with LID practices as compared to traditional stormwater treatment practices result in significant cost savings ranging between 15 percent and 80 percent less than traditional practices. BMPs consist of practices designed to infiltrate runoff for groundwater recharge, reduce runoff volume, and capture rainwater for reuse. Programs under development include pilot projects, retrofitting of existing facilities, new development standards, and assistance in ordinance development.

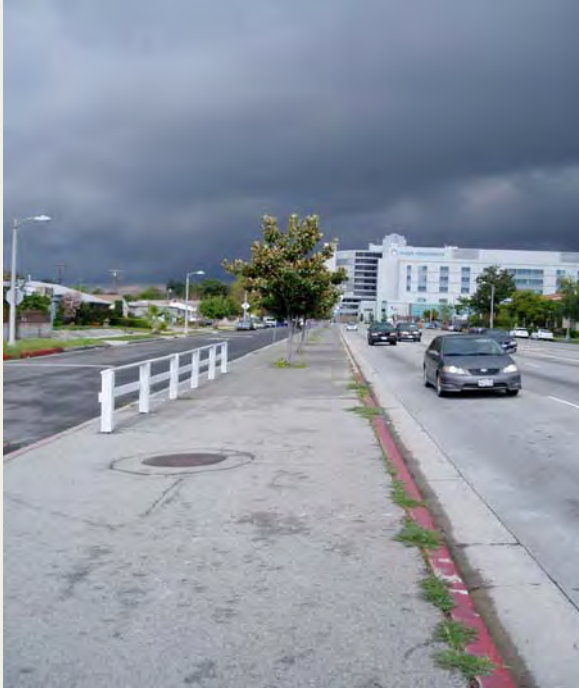
### Retrofit of LADWP Facilities to Meet LID Standards

LADWP is assessing its existing facilities for potential retrofits using LID BMPs. LID BMPs under consideration include pervious pavement, stormwater capture, curb cuts, bioretention cells, and amended soils. Expected benefits include:

- Increased groundwater recharge.
- Decreased outdoor water use.
- Increased compliance with stormwater regulations.

## CASE STUDY: Woodman Avenue Multi-Beneficial Stormwater Capture Project

Originally proposed by the local Panorama City Neighborhood Council for the Tujunga-Pacoima Watershed Plan, the Woodman Avenue project represents an innovative example of stormwater capture, which includes extensive benefits for the environment, the City's groundwater basin, and the surrounding community. The Woodman Avenue median is located along the west side of Woodman Avenue from Lanark Street to Saticoy Street in Panorama City.



The project's construction will be relatively simple but effective. The project will capture surface runoff from approximately 130 acres that currently flows along street gutters to storm drains, through the Tujunga Wash and ultimately down the Los Angeles River and into the Pacific Ocean. Instead flows will now be directed through pre-treatment devices into a vegetated swale and an underground retention system for groundwater basin infiltration. The vegetated swale and underground retention/infiltration system will replace an existing 16-foot wide, 3,500-foot long concrete median. After construction of the project, participants will conduct active monitoring of water flows, water quality, and vegetation for approximately three years. This data should provide valuable information to facilitate the development of future projects, and optimize system processes.

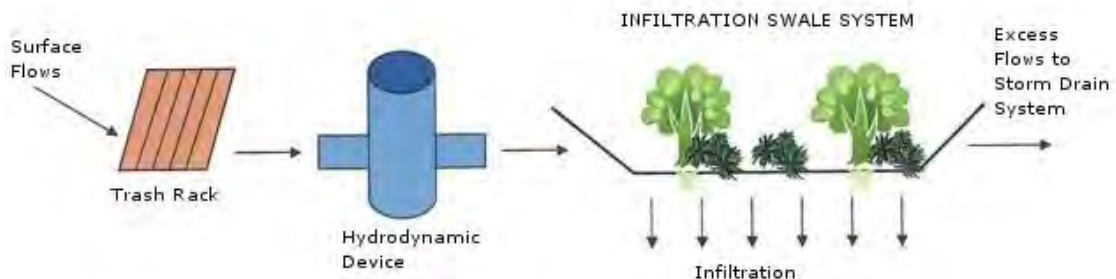
The direct water resource related benefits from this project are three fold. First, the additional water captured will recharge the San Fernando Groundwater Basin with approximately 80 AF per year. This replenishes the City's local groundwater supply, and helps protect pumping rights for City, which ultimately guarantees a more reliable water supply. Secondly, diverted flow alleviates local flooding, particularly during sizable rain events. Finally, the infiltration prevents contaminant carrying runoff and debris from entering local waterways and ultimately coastal areas.

Also recognized are the Community benefits associated with this project. These include creation of open space enhancements such as improved aesthetics and pedestrian access near schools, a walking path, benches, and native vegetation. The River Project will be running an active education program with the local community, including workshops with nearby business owners/residents and the introduction of a curriculum for students at the local elementary school. The organization's goal is to get the students involved in monitoring and maintenance of the project as part of their service learning requirements. Establishing knowledge of sustainable water supplies with the City's youth is an investment in constituent water use practices for generations to come.

Project participants include the Panorama City Neighborhood Council, Council District 6, the Los Angeles Bureau of Sanitation, the Los Angeles Bureau of Street Services, the State of California Water Resources Control Board (SCWRCB), The River Project, and LADWP. This cooperative partnership is anticipating the project's construction to begin in 2012.

State funding used for the project is provided through Proposition 50. SCWRCB has dedicated \$1.6 million through the CALFED Watershed Grant Program, which covers roughly half of the overall project cost.

Melanie Winter from The River Project speaks positively of this stormwater capture project: "The community's involvement in the watershed planning process helped them identify a prime opportunity site that maximizes all the potential benefits. It helps reduce our dependence on imported supplies, addresses peak flows, improves water quality, and re-establishes habitat. It's gratifying to receive State funding to work in a well-rounded partnership to implement this integrated watershed project conceived at the grassroots level."



- Improved environmental conditions for employees and the public.
- Improved public image.
- Increased awareness of LID and provide examples for residents.
- Compliance with Model Water Efficient Landscape Ordinance.

### **New LADWP Facility Development Using LID Standards**

LADWP's Watershed Management Group is developing a framework for implementation of LIDs and BMPs during the new facility development process. Within the framework, LID and BMPs are taken into consideration during the planning, design, implementation, and maintenance processes associated with new LADWP facilities. Benefits include:

- Reductions in costs associated with stormwater infrastructure and landscape maintenance.
- Reduced costs for grading by using natural drainage.
- Reduced sidewalk costs by using narrower sidewalks.
- Increased groundwater recharge.
- Reduced runoff volume and pollutant loading.
- Reductions in long-term maintenance and operation costs by using climate appropriate landscaping.
- Reduction in life cycle costs of replacing or rehabilitating pipe and below ground infrastructure.

### **Assistance in Ordinance Development**

LADWP is represented on the City of Los Angeles Landscape & Stream Protection Ordinances Joint Meeting Committee through the Watershed Management Group. Other committee members include

the Department of Recreation and Parks, the Department of Public Works, the Department of Environmental Affairs, the City Planning Department, and the Department of Building and Safety. The committee is tasked with developing ordinances for city-wide implementation that will reduce water use and improve groundwater recharge among other multiple benefits. Ordinances under review include the:

- Green Building Ordinance using the US Green Building Council's Leadership in Energy and Environmental Design (LEED) Green Building Rating System.
- LID Ordinance to incorporate improvements in stormwater management at the point of origin.
- Stream Protection Ordinance to incorporate methodologies for improving surface and groundwater quality.
- Hillside Ordinance revisions to include modifications in policies regarding front yards, side yards, height, fire protection, street access, lot coverage, off-street parking requirements, and exceptions in relation to the ordinances above.

### **7.6.5 Future Distributed Stormwater Programs**

LADWP continues to investigate the potential for implementation of future distributed stormwater programs. Through its Watershed Management Group, LADWP will continue to develop partnerships and programs to improve utilization of stormwater runoff for outdoor water use and groundwater recharge. Potential programs that could be considered in the future include rain barrel/cistern/rain garden rebates and retrofit incentives for installation of LID BMPs.

## 7.7 Integrated Regional Water Management Plan (IRWMP) Program

---

LADWP is a participating agency in the IRWMP which encompasses 92 cities in the Greater Los Angeles County Region. The IRWMP aims to address the water quality, resource, and supply issues of the region. A final plan was adopted on December 16, 2006.

Highlights of the plan that pertain to watershed issues include:

- Short and long term objectives to comply with water quality regulations (including TMDLs) by improving the quality of urban runoff, stormwater, and wastewater.

- Optimize local water resources to reduce the region's reliance on imported water.
- Long term priority to protect groundwater supplies through stormwater recharge.
- Target goal to reduce and reuse 150,000 AFY (40%) of dry weather urban runoff and capture and treat an additional 170,000 AFY (50%) for a total target of 90%.
- Target goal to reduce and reuse 220,000 AFY (40%) of stormwater runoff from developed areas and capture and treat an additional 270,000 AFY (50%) for a total of 90%.

For more detailed information on the IRWMP, please refer to Chapter 10.



## Exhibit 7G Cost Analysis

Water Source	Water Yield (AFY)	Average Unit Cost (\$/AF)
Centralized Stormwater Capture <sup>1</sup>	25,950	\$60 - \$300
Distributed Stormwater Capture		
Urban Runoff Plants <sup>2</sup>	5,000	\$4,044
Rain Barrels <sup>3</sup>	2,400	\$278 - \$2,778
Cisterns <sup>4</sup>	8,000	\$2,426
Rain Gardens <sup>5</sup>	5,960	\$149 - \$1,781
Neighborhood Recharge <sup>6</sup>	12,000	\$3,351

### Notes:

1. Water Yield and cost are based on LADWP's current planned centralized stormwater capture projects. Additional centralized stormwater capture potential will be identified once the Stormwater Capture Master Plan is complete. Cost assumes 50 year project life.

2. Source: City of Los Angeles Integrated Resources Plan (2004); updated from 2004 to 2009 dollars using annual CPI index for LA-Riverside-Orange County MSA .

3. Source: TreePeople. Assumes 30 year life, one 55 gallon barrel per residence, 15.6 in annual rainfall (LA average) with 18 rain events per year (> ¼ in), and a collection roof area of 500 square feet. Minimum case assumes only material cost of \$75 barrel and infiltration of 50 percent of barrel overflow into a permeable area such as a rain garden. Maximum case assumes \$250 per barrel with installation cost included, and zero infiltration of overflow (worst case). Water yield assumes median between min/max range with 400,000 residences; 2010 dollars

4. Source: City of Los Angeles Integrated Resources Plan (2004); updated from 2004 to 2009 dollars using annual CPI index for LA-Riverside-Orange County MSA; capturing and reusing stormwater on-site for schools and government only.

5. Source: TreePeople. Assumes 30 year life, 15.6 in annual rainfall, an average roof collection area of 500 square feet, \$2.50 - \$25.66 / ft<sup>2</sup> (min/max) for rain garden construction, and 26.6- 31.0 ft<sup>2</sup> (min/max) rain garden size with 5.3% - 6.2% of contributing roof area respectively. Yield is based on 400,000 residences; 2010 dollars

6. Source: City of Los Angeles Integrated Resources Plan (2004); updated from 2004 to 2009 dollars using annual CPI index for LA-Riverside-Orange County MSMSA.

## 7.8 Cost Analysis

Exhibit 7G compares side by side the various watershed management opportunities LADWP is pursuing and/or investigating to add to its water portfolio.

It is important to note that the centralized stormwater capture values are based on the planned projects listed in Section 7.5. LADWP is currently compiling a Stormwater Capture Master Plan (see Section 7.3) which will investigate the maximum potential for stormwater capture within the City (for both centralized and distributed capture). Nevertheless, even with this fraction of the potential, it is clear that centralized stormwater capture is a very cost

effective, plentiful water supply asset to be pursued. Recognizing its great potential, LADWP will proceed with its efforts on the centralized stormwater capture projects listed in Section 7.5, and closely monitor findings of the Stormwater Capture Master Plan to determine future potential centralized stormwater capture projects.

Distributed stormwater capture values are based on the maximum potential achievable by the City. While the cost listed is high, distributed stormwater capture options are highly variable based on a variety of factors such as the magnitude of the overall program, project locations, etc. Furthermore, distributed stormwater capture projects yield additional benefits to the public outside of water supply generation such

as flood control, restored native habitat, community beautification, public right of way improvements, water conservation, as well as private residence safety and aesthetic improvements. LADWP will continue to investigate these options to evaluate the best approach to establish a cost effective program that will help add to LADWP's water portfolio.



## 7.9 Summary

There is a significant potential for increased stormwater capture in the City to create new water supplies. While stormwater capture occurs to replenish the SFB, the majority of stormwater runoff is not captured. Increased urbanization has decreased natural infiltration, thereby contributing to declines in local groundwater levels. Given the significant potential increased stormwater capture can play in a local, reliable water supply, LADWP is developing a Stormwater Capture Master Plan to determine overall stormwater capture targets and strategies to achieve those targets over the next twenty years.

City departments, other governmental agencies, non-profit organizations and numerous stakeholders recognize the necessity for public agencies to coordinate their activities toward improving stormwater capture. Increased stormwater capture can be used to augment local water supplies, improve water quality, restore natural waterways, and enhance neighborhoods.

For water supply benefits, stormwater can be captured in rain barrels or cisterns for reuse; or infiltrated through spreading basins, rain gardens, underground infiltration galleries, permeable surfaces or other green infrastructure and low impact development Best Management Practices.

### **Increased Groundwater Production due to Stormwater Infiltration**

The UWMP projects that by 2035 there will be a minimum of 15,000 AFY of increased groundwater pumping in the SFB due to water supply augmentation through stormwater infiltration. In order to increase groundwater production, it must be determined that not only have groundwater levels recovered to sustain existing safe yield pumping amounts, but documented additional infiltration is occurring that could potentially increase the safe yield. Increasing the safe yield will require concurrence by the Watermaster and the courts to amend the basin judgment. Amending the judgment would be a lengthy process involving all basin pumpers.

Existing managed infiltration by the LACFCD results in an average of 25,782 AFY of recharge (see Exhibit 7A). LADWP has planned projects to double this amount (see Exhibit 7C). However, at this time there is not enough information to determine the quantity of additional stormwater infiltration required to restore groundwater levels required to sustain safe yield pumping, or to justify an increase in the safe yield. More studies must be conducted to determine how much more infiltration must be developed to increase the safe yield and groundwater

production. The Stormwater Capture Master Plan will identify the potential acre-feet per year quantities available for recharge, and develop an implementation plan to augment the groundwater basin through centralized and decentralized infiltration projects and programs.

In addition to the proposed LADWP stormwater infiltration projects identified in Exhibit 7C, initiatives such as the proposed City of Los Angeles Low Impact Development Ordinance will augment stormwater infiltration by requiring stormwater capture for new development.

### Capture and Reuse

By 2035, the UWMP projects 10,000 AFY of additional water conservation through rain barrels and cisterns. There have been some limited programs to distribute rain barrels, but much more remains to be done to achieve these projected stormwater capture amounts. The LADWP Stormwater Capture Master Plan will help identify how to achieve this goal.

Exhibit 7H summarizes existing and projected increased annual average stormwater capture and infiltration capability.

## Exhibit 7H Stormwater Capture Summary

### Existing and Planned Annual Average Centralized Stormwater Capture

Estimated existing annual average centralized stormwater infiltration	25,017 AFY
Planned increase in annual average centralized stormwater infiltration	25,950 AFY
<hr/>	
Total Existing and Planned Annual Average Stormwater Infiltration	50,967 AFY

### Projected Total Increase in Water Supplies from Stormwater Capture

Projected 2035 increased annual groundwater production	15,000 AFY
Projected 2035 distributed stormwater capture and reuse	10,000 AFY
<hr/>	
Total Projected 2035 Increased Water Supplies	25,000 AFY





## Chapter Eight

# Metropolitan Water District Supplies

## 8.0 Overview

---

As a member agency, the City of Los Angeles purchases water from the Metropolitan Water District of Southern California (MWD) to supplement its supplies from local groundwater, Los Angeles Aqueduct (LAA) deliveries, and recycled water. LADWP has historically purchased MWD water to make up the deficit between demand and other City supplies. As a percentage of the City's total water supply, MWD water varies from 4 percent in Fiscal Year (FY) 1983/84 to 71 percent in FY 2008/09 with the 5-year average of 52 percent between FY 2005/06 and FY 2009/10. Exhibit 1F in Chapter 1 illustrates the City's reliance on MWD water during dry years and increasingly in recent years as LAA supply as been cut back for environmental enhancement projects. Although the City plans to reduce its reliance on MWD supply, it has made significant investments in MWD and will continue to rely on the wholesaler to meet its current and future supplemental water needs.

MWD is the largest water wholesaler for domestic and municipal uses in California providing nearly 19 million people with on average 1.7 billion gallons of water per day to a service area of approximately 5,200 square miles. MWD was formed by the MWD Act and exists pursuant to this statute which was enacted by the California Legislature in 1927. MWD's adopted purpose is to develop, store, and distribute water to

Southern California residents. In 1928, MWD was incorporated as a public agency following a vote by residents in 13 cities in Southern California. Operating solely as a wholesaler, MWD owns and operates the Colorado River Aqueduct (CRA), is a contractor for water from the California State Water Project (SWP), manages and owns in-basin surface storage facilities, stores groundwater within the basin via contracts, engages in groundwater storage outside the basin, and conducts water transfers to provide additional supplies for its member agencies. Today, MWD has 26 member agencies consisting of 11 water districts, one county water authority, and 14 cities, including the City of Los Angeles.

This Urban Water Management Plan projects LADWP's reliance on MWD water supplies will be reduced by half from the current five-year average of 52 percent of total demand to 24 percent by FY 2034/35 under average weather conditions.

### 8.0.1 History

---

Initially formed to import water into the Southern California region, MWD's first project was to build the CRA to import water from the Colorado River. The City of Los Angeles provided the capital dollars to initiate and complete land surveys of all proposed alignments for the Aqueduct. Construction was

financed through \$220 million in bond sales during the Great Depression. Ten years after initiating construction, Colorado River water reached Southern California in 1941. To meet further water demands in the southern California region, MWD contracted with the SWP in 1960 for almost half of the SWP's water supplies which are delivered from the San Francisco Bay-Delta region into Southern California via the California Aqueduct. After completion of the California Aqueduct, deliveries of SWP water were first received in 1972.

voting rights are determined by each agency's assessed valuation. The City of Los Angeles has four Directors on MWD's Board and controls 19.44 percent of the vote. MWD's Administrative Code defines various tasks which the Board has delegated to MWD staff. A General Manager oversees MWD staff. The General Manager, General Auditor, General Counsel, and Ethics Officer serve under direction and authority given directly by the Board.

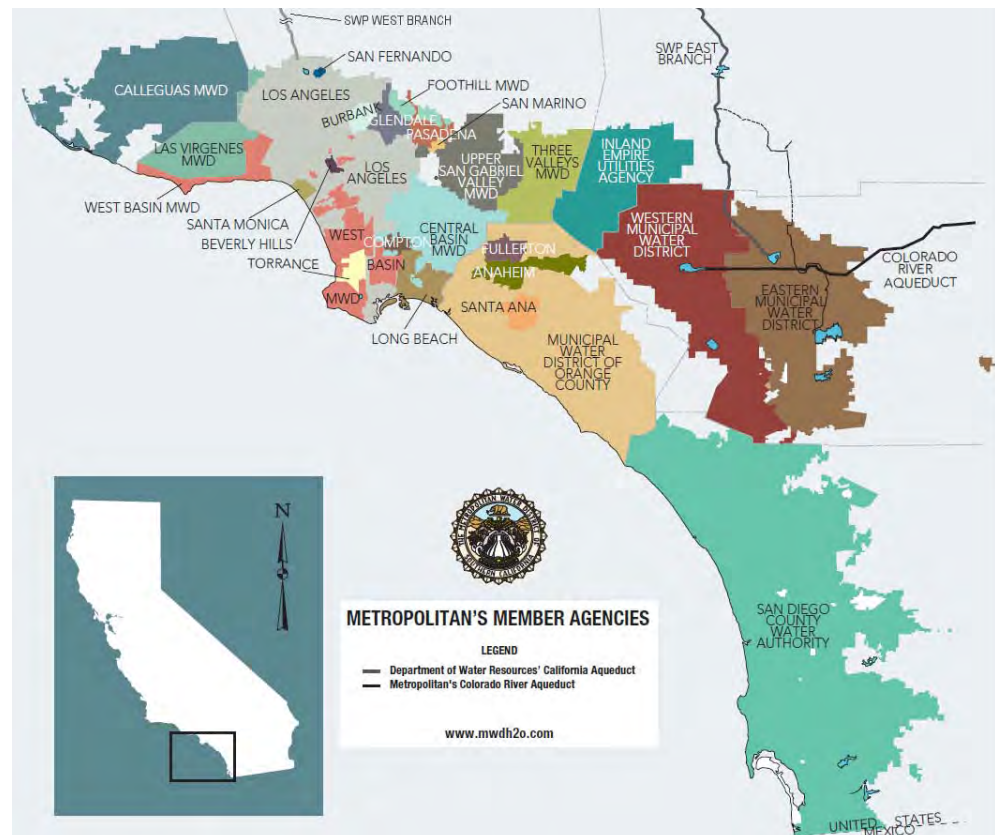
### 8.0.2 Governance

MWD is governed by a Board of Directors composed of 37 individuals with a minimum of one representative from each of MWD's 26 member agencies. The allocation of the directors and

### 8.0.3 Service Area

Originally serving an area of 675 square miles in 1928, MWD's service area has grown to approximately 5,200 square miles serving 19 million people via its 26 member agencies. MWD's service area covers portions of Los Angeles, Ventura, Orange, Riverside, San Bernardino, and

#### Exhibit 8A MWD Service Area



Courtesy of The Metropolitan Water District of Southern California

## Exhibit 8B Major MWD Facilities Summary

San Diego counties as depicted in Exhibit 8A. MWD member agencies serve 152 cities and 89 unincorporated areas. Member agencies provide wholesale, retail, or a combination of wholesale/retail water sales in their individual service territories.

### 8.0.4 Major Infrastructure

MWD delivers approximately 6,000 AF per day of treated and untreated water to its member agencies through its vast infrastructure network. Major facilities include the CRA, pumping plants, pipelines, treatment plants, reservoirs, and hydroelectric recovery power plants. A summary of the major facilities and capacities are provided in Exhibit 8B and Exhibit 8C illustrates the geographic locations of the facilities.

Facility	Units	Capacity
<b>Colorado River Aqueduct</b>		
Aqueduct	242 miles	1.3 million AFY
Pumping Plants	5 plants	1,617 feet of total lift
<b>Pipelines</b>	819 miles	
<b>Water Treatment Plants</b>		
Joseph Jensen		750 mgd
Robert A. Skinner		630 mgd
F.E. Weymouth		520 mgd
Robert B. Diemer		520 mgd
Henry J. Mills		220 mgd
Total Treatment Capacity		2,640 mgd
<b>Reservoirs</b>		
Diamond Valley Lake		810,000 AF
Lake Matthews		182,000 AF
Lake Skinner		44,000 AF
Copper Basin		24,200 AF
Gene Wash		6,300 AF
Live Oak		2,500 AF
Garvey		1,600 AF
Palos Verdes		1,100 AF
Orange County		212 AF
Total Reservoir Capacity		1,071,912 AF
<b>Hydroelectric Recovery Plants</b>	16 plants	122 megawatts

### Exhibit 8C Major MWD Facilities



Courtesy of The Metropolitan Water District of Southern California

## 8.1 Supply Sources

---

Colorado River supplies, State Water Project supplies, In-Basin Storage, Outside-Basin Storage, and Water Transfers together comprise MWD's total system water supply sources. These sources provide supplemental water to meet the demands in Ventura, Los Angeles, Riverside, Orange, San Bernardino and San Diego Counties.

### 8.1.1 Colorado River

---

The Colorado River forms California's border with Arizona to the east. The drainage area in California that contributes water to the Colorado River is relatively small and has an arid climate. Accordingly, California has no major tributaries contributing water to the Colorado River.

The Colorado River Board of California is the California state agency given authority to protect the interests and rights of the state and its citizens in matters pertaining to the Colorado River. The Board is comprised of 10 gubernatorial appointees representing the LADWP, MWD, San Diego County Water Authority, Palo Verde Irrigation District, Coachella Valley Water District, Imperial Irrigation District, Department of Water Resources, Department of Fish and Game, and two public members.

#### 8.1.1.1 The Law of the River

---

The Secretary of the Interior is vested with the responsibility to manage the mainstream waters of the Colorado River pursuant to applicable federal law. This responsibility is carried out consistent with a body of documents referred to as the Law of the River. Water rights to Colorado River water are governed by a complex

collection of federal laws, state laws, a treaty with Mexico, other agreements with Mexico, Supreme Court decrees, contracts with the Secretary, interstate compacts, state, and administrative actions at the federal and state levels. Collectively, these documents and associated interpretations are commonly referred to as the "Law of the River" and govern water rights and operations on the Colorado River.

The following are particularly notable among these documents:

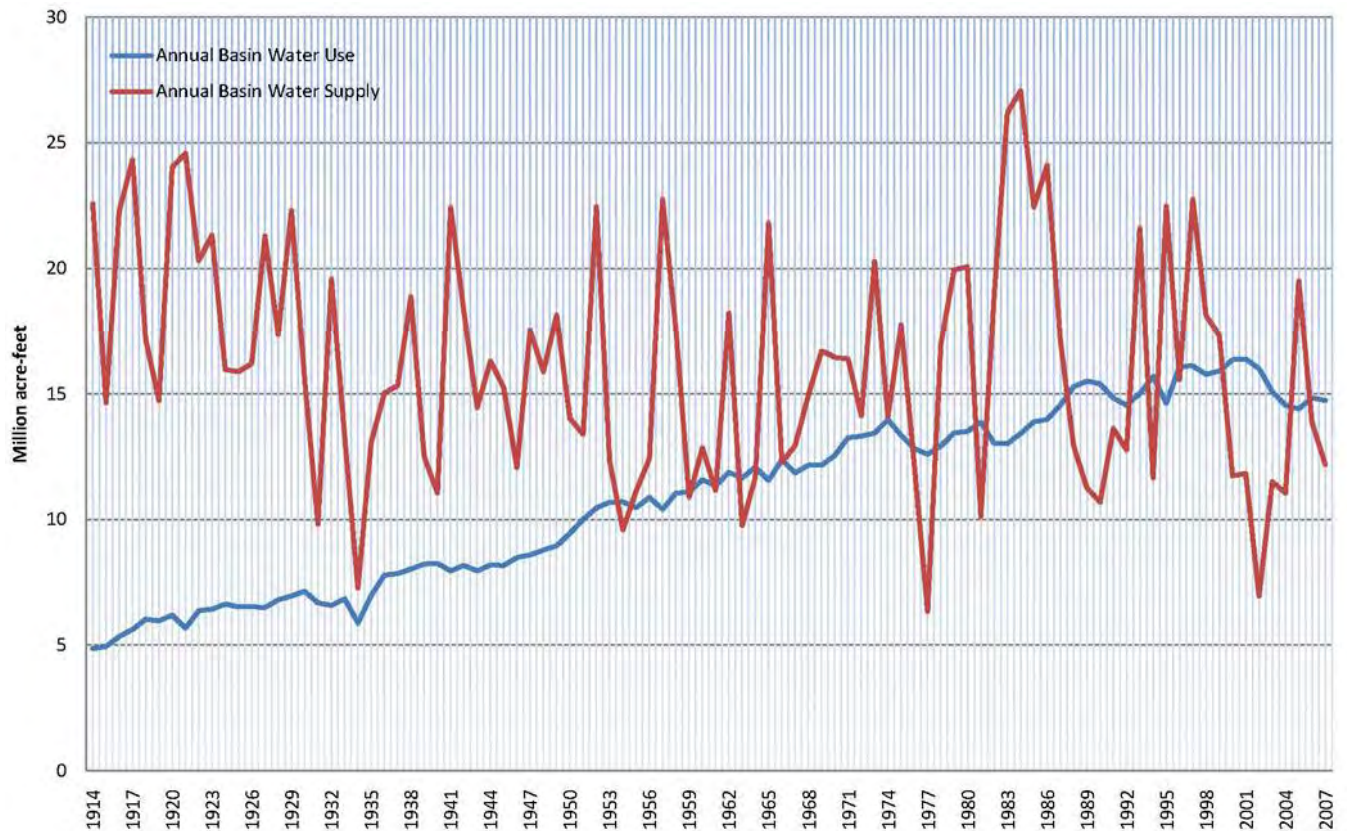
1. The Colorado River Compact of 1922, which apportioned beneficial consumptive use of water between the Colorado River Upper Basin and Lower Basin, and defined the term "States of the Lower Division" to mean the States of Arizona, California, and Nevada. Serving as the basis of the "Law of the River," the Compact apportioned water to each basin in anticipation of a dam on the Colorado River. The Upper Basin is the portion of the Basin upstream of Lee Ferry, Arizona, while the Lower Basin is downstream of this point. Each basin was apportioned 7.5 million acre-feet (MAF) annually, and the Lower Basin received the option to an additional 1 MAF annually based on excess flows. California is within the Lower Basin along with Arizona and Nevada.
2. The Boulder Canyon Project Act (Act) of 1928, enacted by Congress to authorize construction of Hoover Dam and the All-American Canal. The Act required that water users in the Lower Basin have a contract with the Secretary, and established the responsibilities of the Secretary to direct, manage, and coordinate the operation of Colorado River dams and related works in the Lower Basin. The Act stipulated conditions, one of which required California to limit Colorado River water use to 4.4 MAF annually plus one-half of the excess water unapportioned by the Colorado River Compact. To satisfy the condition, the California Legislature enacted the Limitation Act in 1929 limiting its use of Colorado River water to the basic apportionment of 4.4 MAF.

3. The California Seven Party Agreement of 1931. Developed in response to the Limitation Act and through regulations adopted by the Secretary, which established the relative priorities of rights among major users of Colorado River water in California. The Seven Party Agreement apportioned California's share of Colorado River water to California contractors. Within the agreement, priorities were established for each of the four agencies holding contracts for Colorado River water with the U.S. Bureau of Reclamation. These priorities are shown in Exhibit D. Seven priorities were established with the first four priorities satisfying California's allocation of 4.4 MAF annually and the fifth and sixth priorities relating to California's share of excess Colorado River flows. MWD holds the fourth and fifth priorities. The fourth priority allocates 550 thousand acre-feet (TAF) of California's apportionment to MWD and the fifth priority allocates 662 TAF of California's share of excess flows to MWD.
4. The 1944 Treaty (and subsequent minutes of the International Boundary and Water Commission) related to the quantity and quality of Colorado River water delivered to Mexico. The Treaty guaranteed an annual quantity of 1.5 MAF to be delivered in accordance with the provisions of the Treaty.
5. The 1963 United States Supreme Court Decision in *Arizona v. California*, which confirmed the Lower Basin mainstream apportionments of:
  - 2.8 million acre-feet per year (AFY) for use in Arizona,
  - 4.4 million AFY for use in California, and
  - 0.3 million AFY for use in Nevada provided water for Indian reservations and other federal reservations in Arizona, California, and Nevada; and confirmed the significant role of the Secretary in managing the mainstream Colorado River within the Lower Basin.
6. The 1964 United States Supreme Court Decree (Decree) in *Arizona v. California* which implemented the Supreme Court's 1963 decision; allocated 50 percent of the surplus water available for use in California; and allowed the Secretary to release water apportioned to but unused in one state for use in the other two states. The Decree was supplemented over time after its adoption and the Supreme Court entered a Consolidated Decree in 2006 which incorporates all applicable provisions of the earlier-issued Decrees.
7. The Colorado River Basin Project Act of 1968, which authorized construction of a number of water development projects including the Central Arizona Project (CAP); provided existing California, Arizona, and Nevada water contractors a priority over the CAP and other users of the same character in Arizona and Nevada whenever less than 7.5 million AFY is available; and required the Secretary to develop the Long Range Operating Criteria and issue an Annual Operating Plan for mainstream reservoirs.

**Exhibit 8D**  
**Listing of Priorities - Seven Party Agreement**

Priority Number	Agency and Description of Service Area	Beneficial Consumptive Use (Acre-feet/year)
1	Palo Verde Irrigation District - 104,500 acres	3,850,000
2	Yuma Project, California Portion, not exceeding 25,000 acres	
3(a)	Imperial Irrigation District	
3(b)	Palo Verde Irrigation District - 16,000 acres	550,000
4	Metropolitan Water District, City of Los Angeles and/or others on the coastal plain	
5	Metropolitan Water District, City of Los Angeles and/or others on the coastal plain	662,000
6(a)	Imperial Irrigation District	300,000
6(b)	Palo Verde Irrigation District - 16,000 acres of adjoining mesa	
	<b>Total</b>	<b>5,362,000</b>

## Exhibit 8E Historical Annual Colorado River Supply and Use



### 8.1.1.2 Colorado Supply Reliability

Exhibit 8E illustrates the historical annual Colorado River Basin supply and demand beginning 1914 through 2007. The steady increase of demand has caught up with the supply.

Reliability of CRA water for MWD has decreased overtime as a consequence of multiple events. Historically, California had used up to 5.4 million AFY as Arizona and Nevada were not using their normal apportionments of Colorado River water and surplus water was made available by the Secretary. The 1964 Decree and the 2006 Consolidated Decree of the US Supreme Court in *Arizona v. California* confirmed California's allocation was limited to 4.4 MAF annually. As a result, MWD can now only rely on its fourth priority allocation of 550 TAF annually. Prior to this, MWD was able to satisfy its fifth priority allocation with Nevada and Arizona's unused water. However, in 1985

Arizona began increasing deliveries to its Central Arizona Project reducing the availability of unused apportionment to fill MWD's fifth priority.

Because of dry years on the Colorado River system and Arizona and Nevada using their full apportionment, the U.S. Secretary of Interior asserted that California must come up with a plan to live within its 4.4 MAF apportionment. Therefore, users from California have developed California's Colorado River Water Use Plan (California Plan). The users included: MWD, Palo Verde Irrigation District (PVID), Imperial Irrigation District (IID), and Coachella Valley Water District (CVWD). This plan identifies actions that California will take to operate within its 4.4 million acre-foot entitlement. Exhibit 8F and Exhibit 8G illustrate the historical total Colorado River Basin storage and the historical Lake Mead elevation, which show a protracted dry period beginning around 1999.



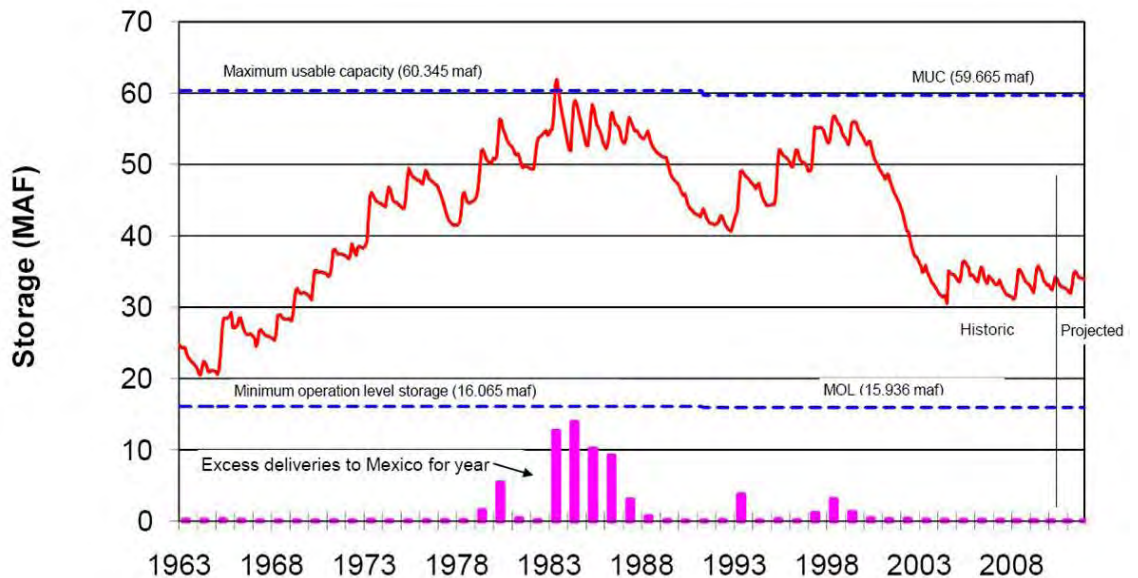
California currently consumes its normal apportionment of 4.4 million AFY. The order of priority is as follows:

1. PVID - gross area of 104,500 acres of land in the Palo Verde Valley.
2. Yuma Project-Reservation Division - not exceeding a gross area of 25,000 acres in California.
- 3(a). IID - lands in the Imperial Valley served by the All-American Canal. Export out of basin, primarily agricultural usage. Also, second 63,000 AF in priority 6(a) and balance of any remaining priority 6(a) and 7 water available.
- 3(b). CVWD - lands in the Coachella Valley served by the Coachella Branch of the All-American Canal. Export out of basin, agricultural usage. Also third 119,000 AF in priority 6(a) and balance of any remaining priority 6(a) and 7 water available.
- 3(c). PVID - 16,000 acres of land on the Lower Palo Verde Mesa, also priority 6(b).
4. MWD - 550,000 AF, also 662,000 AF in priority 5, and first 38,000 AF in 6(a)

A component of the California Plan was completion of the Quantification Settlement Agreement (QSA) in 2003, which established baseline water use for each California party with Colorado River water rights. Key to the agreement is the quantification of IID at 3.1 MAF and CVWD at 330 TAF. Completion of the QSA facilitates the transfer of water from agricultural agencies to urban water suppliers by allowing water conserved on farm land to be made available for urban use. As a result of litigation, the QSA and eleven other agreements were ruled invalid on February 11, 2010. MWD in conjunction with CVWD and the SDCWA have appealed the court's decision. Ultimately, the total impact of the court's decisions on MWD's Colorado River supplies cannot be determined at this time pending the outcome of the appeal. However, MWD's existing conservation, land fallowing, and transfer programs for Colorado River supplies are independent of the QSA and will not be impacted by the QSA lawsuit.

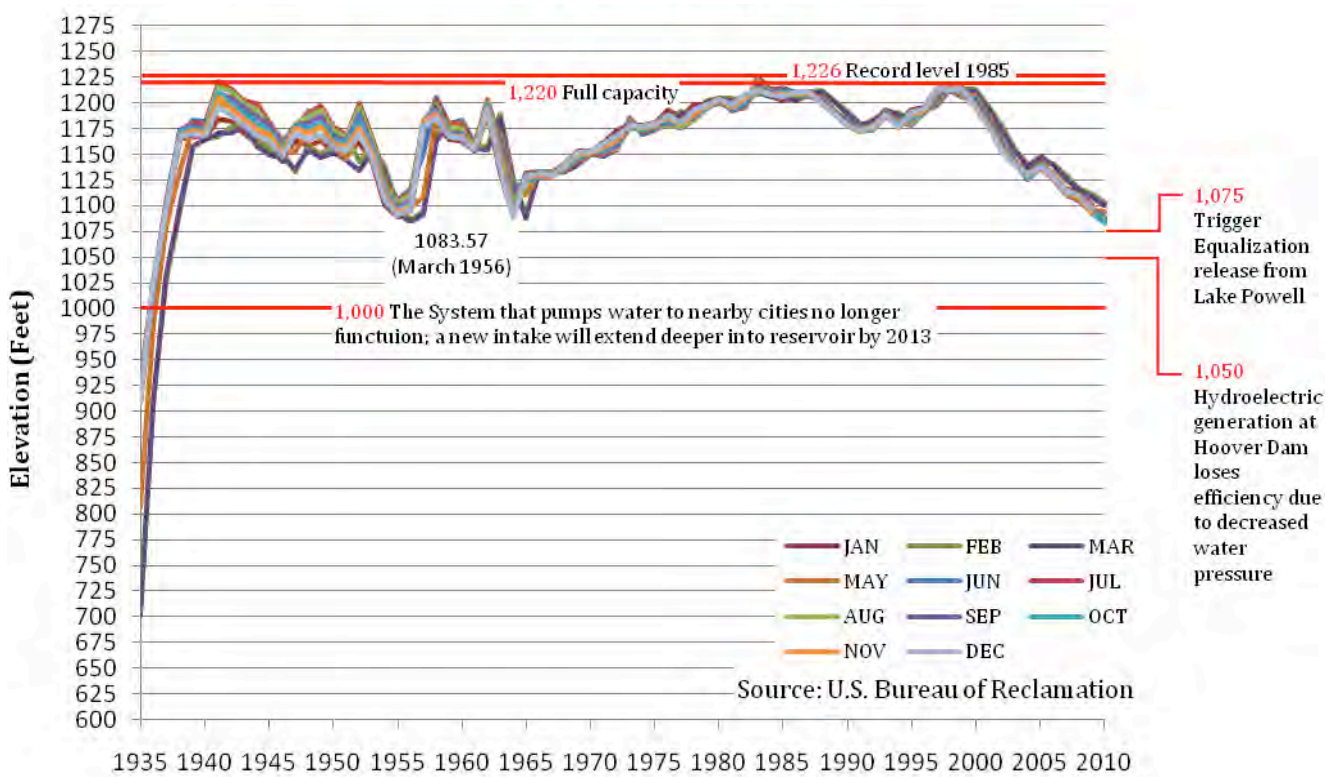
Along with MWD's apportionment, MWD has developed a number of water supply programs to improve reliability of Colorado River supplies, such as agricultural water transfers and storage programs, and has multiple programs under development as listed in Exhibit 8G. Developed programs in conjunction

**Exhibit 8F  
Historical Total Colorado River Basin Storage**





**Exhibit 8G**  
**Historical Lake Mead Elevation**



The bathtub ring at Lake Mead, August 2010, lake elevation 1,087 feet.

**Exhibit 8H**  
**MWD's CRA Forecast Supplies in 2035, Average Year (1922 - 2004 Hydrology)**

Program	Supply (Thousands of AF)/ Year
<b>Current</b>	
Basic Apportionment - Priority 4	550
Imperial Irrigation District/MWD Conservation Program	85
Priority 5 Apportionment (Surplus)	13
Palo Verde Irrigation District Land Management Crop Rotation and Water Supply Program	133
Lower Colorado Water Supply Project	5
Lake Mead Storage Program	400
Quechan Settlement Agreement Supply	7
Forbearance for Present Perfected Rights	-47
Coachella Valley Water District State Water Project/QSA Transfer Obligation	-35
Desert Water Agency and Coachella Valley Water District SWP Table A Obligation	-155
Desert Water Agency and Coachella Valley Water District SWP Table A Transfer Call-back	82
Desert Water Agency and Coachella Valley Water District Advance Delivery Account	73
Drop 2 Reservoir Funding	25
Southern Nevada Water Authority Agreement	0
<b>Subtotal of Current Programs</b>	<b>1,136</b>
<b>Programs Under Development</b>	
Additional Palo Verde Irrigation District Transfers	62
Arizona Programs - Central Arizona Project	50
California Indians/Other Agriculture	10
ICS Exchange	25
Agreements with Coachella Valley Water District	35
Hayfield Groundwater Extraction Project	0
<b>Subtotal of Proposed Programs</b>	<b>182</b>
<b>Additional Non-MWD CRA Supplies</b>	
San Diego County Water Authority/ Imperial Irrigation District Transfer	200
Coachella and All-American Canal Lining	
To San Diego County Water Authority	80
To San Luis Rey Settlement Parties <sup>1</sup>	16
<b>Subtotal of Non-MWD CRA Supplies</b>	<b>296</b>
<b>Maximum CRA Supply Capability<sup>2</sup></b>	<b>1,614</b>
<b>Minus Supply CRA Capacity Constraint of 1.25 MAF Annually</b>	<b>-364</b>
<b>Maximum Forecast CRA Deliveries</b>	<b>1,250</b>
<b>Minus Non-MWD Supplies<sup>3</sup></b>	<b>-296</b>
<b>Maximum MWD Supply Capability<sup>4</sup></b>	<b>954</b>

1. Subject to satisfaction of conditions specified in agreement among MWD, the US, and the San Luis Rey Settlement Parties

2. Total amount of supplies available without taking into consideration of CRA capacity constraint of 1.25 MAF annually.

3. Exchange obligation for San Diego County Water Authority - Imperial Irrigation District transfer and the Coachella and All-American Canal Lining Projects.

4. The amount of CRA water available to MWD after meeting exchange obligations.

Source: 2010 Regional Urban Water Management Plan, Metropolitan Water District of Southern California

with MWD's apportionment will provide MWD with approximately 1.14 MAF in 2035 under an average year (1922 – 2004 hydrology). Proposed programs under development could add another 182 TAF per year. Non-MWD supplies conveyed through the CRA are forecast at 296 TAF for a total CRA supply capability of 1.61 MAF. However, the CRA has a supply capacity constraint of 1.25 MAF. After subtracting MWD's conveyance obligation of non-MWD supplies, MWD's supplies for 2035 under average year, single-dry year (1977 hydrology), and multi-dry year (1990 – 1992 hydrology) scenarios are all forecast at 954 TAF. Exhibit 8H summarizes the CRA supply forecast for 2035 under an average year.

### 8.1.1.3 Water Quality Issues

Water quality issues for Colorado River supplies cover high salinity levels, perchlorate, nutrients, uranium, chromium VI, N-nitrosodimethylamine (NDMA), and pharmaceuticals and personal care products (PPCPs). High salinity levels present the most significant issue and the only foreseeable water quality constraint for the Colorado River supply. MWD expects its source control programs for the CRA to adequately address the other water quality issues. MWD has also bolstered its water security measures across all of its operations since 2001, including an increase in water quality tests. Details of MWD's water quality initiatives are available in MWD's 2010 Regional Urban Water Management Plan (RUWMP).

#### Salinity

Water obtained from the Colorado River has the highest salinity levels of all MWD supply sources averaging 630 mg/L since 1976. Salts are eroded from saline sediments deposited in prehistoric marine environments in the Colorado River Basin (Basin), dissolved by precipitation, and conveyed into the Basin's water courses.

Salinity issues have been recognized in the Basin for over 30 years. The seven basin states formed the Colorado River Basin Salinity Control Forum (Forum) to mutually cooperate on salinity issues in the Basin. The Forum recommended the U.S. Environmental Protection Agency (USEPA) to act upon the Forum's proposal and in response the USEPA approved water quality standards and established numeric criteria for controlling salinity increases. Each Basin State adopted the water quality standards, which are designed to limit the flow-weighted average annual salinity level to 1972 levels or below. An outgrowth of the Forum was the Colorado River Basin Control Program. At the core of the program is the reduction in salts entering the river system by intercepting and controlling non-point sources, wastewater, and saline hot springs. Salinity reduction projects have reduced salinity concentration of Colorado River water by over 100mg/L, which equates to approximately \$264 million per year in avoided damages (2005 dollars).

MWD adopted a Salinity Management Policy in 1999 with the goal of achieving salinity concentrations of less than 500 mg/L at delivery. To reduce salinity levels, Colorado River supplies are blended with SWP water supplies to achieve the salinity target. In some years, the target is not possible to achieve as a result of hydrologic conditions that increase salinity on the Colorado River and decrease SWP water available for blending. Additionally, to maximize the use of recycled water for agriculture, MWD attempts to import lower salinity imported water during the spring/summer months to reduce salinity levels in recycled water supplies.

#### Perchlorate

In 1997 perchlorate was first detected in the Colorado River. It was attributed to an industrial site upstream of the Las Vegas Wash in Nevada which drains to the river. Subsequently, an additional perchlorate plume was found to be migrating from an additional industrial site, but had

not reached the Las Vegas Wash. Since the initial discovery of contamination, remediation efforts have significantly reduced perchlorate loading from the Las Vegas Wash. At Lake Havasu, downstream of the convergence of the Las Vegas Wash and Colorado River, perchlorate levels have decreased from 9 µg/L at their peak in 1998 to less than 6 µg/L in October 2002. Since June 2006, typical levels have been less than 2 µg/L.

## Nutrients

Excessive nutrient levels in water can stimulate algal and aquatic weed growth leading to taste and odor concerns. Nutrients include both phosphorous and nitrogen compounds. Other impacts of algal and aquatic weed growth include reductions in operating efficiencies and potentially provide an additional food source for invasive aquatic species, such as quagga and zebra mussels.

Naturally, the Colorado River system has relatively low concentrations of phosphorous. Additional loading to the system as upstream urbanization increases has the ability to increase phosphorous concentrations and impact MWD's ability to blend low nutrient concentration CRA water with high nutrient concentration SWP water. MWD continues to work with agencies located along the lower Colorado River to improve wastewater management in order to reduce phosphorous loading.

## Uranium

Near Moab, Utah, a 16-million ton pile of uranium tailings located approximately 750 feet from the Colorado River is a potential source of uranium loading to the river. In 1999, the US Department of Energy began remediating the site by removing tailings and treating contaminated groundwater. Complete removal of the pile is expected by 2025 or 2019 if additional funding is secured. MWD is tracking clean-up progress and continues to support rapid clean-up of the site.

To address recent uranium mining claims in the vicinity of the Colorado River and the Grand Canyon Area, MWD has sent letters to the Secretary of Interior to highlight MWD's concern of source water protection and recommended close federal oversight. In 1999, the Department of Interior placed a two-year hold on mining claims for 1 million acres adjacent to the Grand Canyon area to conduct additional analyses and H.R. 644, Grand Canyon Watersheds Protection Act, was introduced in 2009. H.R. 644, if approved, would prohibit new mining activities around the Grand Canyon area.

## Chromium VI

Chromium VI has been detected in a groundwater aquifer in the vicinity of the Colorado River near Topock, Arizona. The source of the contamination is a natural gas compression site operated by Pacific Gas and Electric (PG&E) that previously used chromium VI in its operations. Monitoring upstream and downstream of the site range from non-detect (0.03 µg/L) to 0.06 µg/L which are considered within the background range for the river. MWD is actively involved in the corrective action process through its participation in stakeholder workgroups and partnerships with State and federal regulators, Indian tribes, and other stakeholders. The Final Environmental Impact Report (EIR) for the Topock Chromium VI remediation project is complete and has been certified by California Department of Toxic Substances Control. U.S. Department of Interior has issued a Federal Record of Decision which states that PG&E holds sole responsibility for the substantial threat of the release of Chromium VI near Topock, Arizona. A time-critical removal action is authorized and PG&E's clean-up operations are under the direction and oversight of the Department of Toxic Substances Control.

## NDMA and Pharmaceuticals and Personal Care Products

N-nitrosodimethylamine is a by-product formed by secondary disinfection of some natural waters with chloramines. MWD is



involved with projects to understand the potential sources of NDMA precursors in its source watersheds and to develop treatment strategies to minimize NDMA formation at its water treatment facilities. In 2007, MWD initiated monitoring efforts to measure PPCPs in its source supplies. PPCPs have been detected at very low levels (low ng/L level; parts per trillion) consistent with monitoring results from other utilities. MWD is involved with programs to improve analytical testing methods, characterize PPCP in drinking water sources in California, and effects of PPCPs on groundwater recharge and recycled water use.

### **8.1.2 State Water Project**

MWD began receiving water from the SWP in 1972. MWD is the largest of 29 contractors for water from the SWP, holding a contract for 1.912 MAF per year, or 46 percent of the total contracted amount of the 4.173 MAF ultimate delivery capacity of the project. Variable hydrology, environmental issues, and regulatory restrictions in the San Francisco Bay/Sacramento-San Joaquin River Delta (Bay-Delta) have periodically reduced the quantity of water that the SWP delivers to MWD.

## Exhibit 81 State Water Project Major Facilities



Courtesy of the State of California Department of Water Resources

### 8.1.2.1 Major State Water Project Facilities

---

The SWP is owned by the State of California and operated by the Department of Water Resources (DWR) delivering water to two-thirds of the population of California and 750,000 acres of farmland. The SWP system consists of 701 miles of aqueduct, 34 storage facilities totaling 5.8 MAF of storage, five hydro-electric power plants, four pumping-generating plants, 17 pumping plants, and three pump stations. Exhibit 8I illustrates the location of major SWP facilities. SWP facilities originate in Northern California at Lake Oroville on the Feather River. Water released from Lake Oroville flows into the Feather River, goes downstream to its confluence with the Sacramento River, and then travels into the Bay-Delta. Water is pumped from the Bay-Delta region to contractors in areas north and south of the San Francisco Bay and south of the Bay-Delta. SWP deliveries consist solely of untreated water. In addition to delivering water to its contractors, the SWP is operated to improve water quality in the Bay-Delta region, control flood waters, and provide recreation, power generation, and environmental enhancement.

MWD receives SWP water at three locations: Castaic Lake in Los Angeles County, Devil Canyon Afterbay in San Bernardino County, and Box Spring Turnout at Lake Perris in Riverside County. In addition, MWD has flexible storage rights of 65 TAF at Lake Perris at the terminus of the East Branch of the SWP and 153.95 TAF at Castaic Lake at the terminus of the West Branch.

### 8.1.2.2 Contract Allocations

---

Contract allocations, also known as entitlements, for SWP contractors are provided by DWR in a table commonly

referred to as Table A and shown in Exhibit 8J. Allocations are based on the original projected SWP maximum yield of 4.173 MAF. Table A is a tool used by DWR to allocate fixed and variable SWP costs and yearly water entitlements to the contractors. Table A contract amounts do not reflect actual deliveries a contractor should expect to receive. MWD has a Table A contract amount of 1.912 MAF. MWD's full Table A contract amount was made available to MWD for the first time in 2006.

DWR annually approves the amount of contract allocations SWP contractors will receive. The contract allocation amount received by contractors varies based on contractor demands and projected available water supplies. Variables impacting projected water supplies include snowpack in the Sierra Nevada, capacity available in reservoirs, operational constraints, and demands of other water users. Operational constraints include pumping restrictions related to fish species listed as either threatened or endangered under the federal or state Endangered Species Acts. Contractors' requests for portions of their entitlements cannot always be met. In some years there are shortages and in other years surpluses. In 2008 and 2009, SWP contractors received only 35 percent and 40 percent, respectively, of their SWP contract allocations.

DWR bi-annually prepares the State Water Project Delivery Reliability Report to provide contractors with current and projected water supply availability for SWP. The 2009 draft released in January 2010 indicates expected deliveries for multiple-dry year periods will vary from 32 to 38 percent of maximum Table A amounts and for multiple-year wet periods, 72 to 94 percent of maximum Table A amounts. Overall the report shows increased reductions in water deliveries on average when compared to the previous 2007 report. Factors impacting deliveries include environmental constraints and hydrologic changes as a result of climate change.

**Exhibit 8J  
Table A  
Maximum  
Annual SWP  
Amounts  
(acre-feet)**

**Contractor Maximum SWP Table A**

**North Bay**

Napa County Flood Control and Water Conservation District	29,025
Solano County Water Agency	47,756
<b>Subtotal</b>	<b>76,781</b>

**South Bay**

Alameda County Flood Control and Water Conservation District, Zone 7	80,619
Alameda County Water District	42,000
Santa Clara Valley Water District	100,000
<b>Subtotal</b>	<b>222,619</b>

**San Joaquin Valley**

Oak Flat Water District	5,700
Kings County	9,305
Dudley Ridge Water District	57,343
Empire West Side Irrigation District	3,000
Kern County Water Agency	998,730
Tulare Lake Basin Water Storage District	95,922
<b>Subtotal</b>	<b>1,170,000</b>

**Central Coastal**

San Luis Obispo County Flood Control and Water Conservation District	25,000
Santa Barbara County Flood Control and Water Conservation District	45,486
<b>Subtotal</b>	<b>70,486</b>

**Southern California**

Antelope Valley-East Kern Water Agency	141,400
Castaic Lake Water Agency	95,200
Coachella Valley Water District	121,100
Crestline-Lake Arrowhead Water Agency	5,800
Desert Water Agency	50,000
Littlerock Creek Irrigation District	2,300
Mojave Water Agency	75,800
Metropolitan Water District of Southern California	1,911,500
Palmdale Water District	21,300
San Bernardino Valley MWD	102,600
San Gabriel Valley MWD	28,800
San Geronio Pass Water Agency	17,300
Ventura County Flood Control District	20,000
<b>Subtotal</b>	<b>2,593,100</b>
<b>Delta Delivery Total</b>	<b>4,132,986</b>

**Feather River**

Butte County	27,500
Plumas County Flood Control and Water Conservation District	2,700
Yuba City	9,600
<b>Subtotal</b>	<b>39,800</b>
<b>Total</b>	<b>4,172,786</b>



In addition to MWD's Table A amount, MWD has long term agreements in place to obtain additional SWP supplies through five other programs:

- Article 21
- Turnback Pool
- Yuba River Accord
- San Luis Carryover Storage
- Desert Water Agency and Coachella Valley Water District Table A Transfer

Article 21 is in reference to a provision in the SWP contract with DWR that allows SWP contractors, such as MWD, to take additional water deliveries in addition to Table A amounts. Article 21 water is only available under certain conditions as outlined in Article 21. SWP Article 21 of the contracts permits delivery of water excess to delivery of SWP Table A and some other water types to those contractors requesting it. SWP Article 21 water is apportioned to those contractors requesting it in the same proportion as their SWP Table A.

Turnback Pool (Pool) water allows a contractor that has been allocated Table A annual entitlement that the contractor will not use to sell that water to other SWP contractors through the Pool. If there are more requests from contractors to purchase water from the Pool than the amount in the Pool, the water in the Pool is allocated among those contractors requesting water in proportion to their Table A entitlements. If requests to purchase water from the Pool total are less than the amount of water in the Pool, the sale of water is allocated to the selling contractors in proportion to their respective amounts of water in the Pool.

In 2007, MWD and DWR signed an agreement allowing MWD to participate in the Yuba Dry Year Water Purchase Program. Under this program, transfers are available from the Yuba County Water Agency during dry years up to 2025. MWD

completed purchases of 26.4 TAF and 42.9 TAF in 2008 and 2009, respectively.

As part of the Monterey Amendment, which modified the contractors' long term contracts with DWR, the use of carryover storage by contractors was permitted in the San Luis Reservoir for use during dry years. Carryover storage is curtailed if it impedes with the storage of SWP water for project needs.

MWD entered into a transfer agreement with the DWA and CVWD for their Table A contract amounts in exchange for an equal amount of water from the CRA. Both DWA and CVWD are SWP contractors, but have no physical connections to obtain SWP water. MWD is able to transfer CRA water to both agencies as a result of their locations adjacent to CRA facilities. DWA and CVWD have a combined Table A amount of 1.912 MAF per year. MWD additionally can provide DWA and CVWD with deliveries of MWD's other SWP water supplies and non-SWP supplies utilizing SWP facilities, thus allowing MWD additional flexibility in managing its water supply portfolio.

MWD also engages in short-term transfer agreements using SWP facilities to bolster supplies as opportunities become available as discussed in the Groundwater Storage and Transfers subsection. Historically, MWD has obtained transfers through the Governor's Water Bank, Dry-Year Purchase Programs, and the State Water Contractors Water Transfer Program.

MWD expects to receive 2.046 MAF through its SWP supplies in 2035 under average conditions (1922 – 2004 hydrology). Exhibit 8K summarizes MWD's SWP supplies by program. Current programs are expected to result in 1.441 MAF and programs under development are expected to add an additional 605 TAF. Under multi-year dry conditions (1990 – 1992 hydrology), MWD expects to receive only 956 TAF and 1,003 TAF under a single-dry year (1977 hydrology).

### 8.1.2.3 Water Quality Issues

Water quality issues for SWP supplies include total organic carbon (TOC), bromide, arsenic, nutrients, NDMA, and PPCPs. TOC and bromide in SWP water present the greatest water quality issues and have restricted MWD's ability to use SWP water at various times as the contaminants form disinfection byproducts during water treatment processes. MWD has initiated a process to upgrade its treatment processes to ozone disinfection to reduce formation of disinfection byproducts and lift potential restrictions on SWP water usage. MWD requires low salinity levels of SWP water to meet blending requirements for CRA water, and therefore, any increase in salinity levels in SWP supplies is a concern to MWD.

MWD supported DWR in the establishment of a policy regarding water quality of non-SWP water transported through the SWP system and in the expansion of Municipal Water Quality Investigations Programs to include

additional monitoring and advanced warnings to contractors that may impact water treatment processes.

MWD is utilizing its water supply portfolio options to conduct water quality exchanges to reduce TOC and bromide. MWD has stored SWP water during periods of high water quality in groundwater storage basins for later use when SWP is at a lower water quality. These storage programs were initially designed to provide water during dry SWP conditions, but a few of these programs are now operated for dual-purposes.

TOC and bromide in high concentrations lead to the formation of disinfection byproducts when source water is treated with disinfectants, such as chlorine. Agricultural drainage to the Bay-Delta and seawater comingling with Bay-Delta supplies increases these contaminants. The Bay Delta Conservation Plan (BDCP) has outlined multiple options to improve the water supply reliability and habitat protection, which is being prepared through a collaboration of state, federal, and local water agencies, state and

#### Exhibit 8K MWD Forecast Supplies of SWP Water in 2035, Average Year (1922 - 2004 Hydrology)

Program	Supply (Thousands of AF)
Current	
MWD Table A	1,026
Desert Water Agency and Coachella Valley Water District SWP Table A Transfer	155
San Luis Carryover Storage <sup>1</sup>	208
Article 21 Supplies	52
Yuba River Accord Purchase	0
<b>Subtotal of Current Programs<sup>2</sup></b>	<b>1,441</b>
Programs Under Development	
Delta Conveyance Improvements	605
Integrated Resources Plan SWP Target <sup>3</sup>	0
<b>Subtotal of Proposed Programs<sup>2</sup></b>	<b>605</b>
<b>Maximum SWP Supply Capability<sup>2</sup></b>	<b>2,046</b>

1. Includes carryover water from Desert Water Agency and Coachella Valley Water District.

2. Does not include transfers and water banking associated with SWP.

3. Remaining supply needed to meet Integrated Resources Plan target.

Source: 2010 Regional Urban Water Management Plan, Metropolitan Water District of Southern California

federal fish agencies, environmental organizations, and other interested parties. The overall goal of BDCP is identifying water flow and habitat restoration actions to both improve water supply reliability and recover endangered and sensitive species and their habitats Bay-Delta. MWD is in the process of computing upgrades to its water treatment plants to use ozone as the primary disinfectant. Ozone disinfection is very effective treatment for control of bromate formation and will allow MWD to treat higher quantities of SWP supplies without blending those supplies with CRA water.

## **Arsenic**

SWP supplies not banked in MWD's SWP groundwater storage programs naturally contain low levels of arsenic ranging from non-detect to 4.0 µg/L and do not require additional treatment for arsenic removal. SWP supplies banked in at least one of these groundwater storage programs contain arsenic levels close to or at the regulatory threshold of 10 µg/L requiring additional treatment for arsenic removal. Historically, MWD has at times restricted flows from one groundwater storage program as a result of arsenic levels. One groundwater storage partner has initiated a pilot arsenic removal program, albeit raising the cost of the groundwater storage program. Arsenic can also be removed at water treatment plants by increasing coagulant doses. To handle arsenic removed during water treatment processes, MWD has had to invest in solids handling facilities.

## **Nutrients**

Nutrient levels in SWP water are significantly higher than in Colorado River water. Both phosphorous and nitrogen compounds are a concern in SWP water, but similar to CRA supplies phosphorous is the limiting nutrient. Nutrient sources in SWP water include wastewater discharges, agricultural drainage, and sediments from nutrient rich soils in the Bay-Delta. MWD reservoirs have been temporarily bypassed at times as a result of taste and odor events related

to nutrients leading to short-term supply impacts.

MWD is working with other water agencies also receiving SWP water from the Bay-Delta region to reduce the impact of nutrient loading from wastewater plants discharging to the Bay-Delta. To assist in managing its operations, MWD has implemented an algae monitoring and management program designed to provide warnings in advance of algae and taste and odor issues at its reservoirs allowing adjustments in other system operations.

## **NDMA and Pharmaceuticals and Personal Care Products**

Similar to all of its water supply sources, NDMA and PPCPs are constituents of emerging concern. As described above for Colorado River supplies, MWD is involved with efforts to address both NDMA and PPCPs.

## **Salinity**

Over the long term salinity concentrations in SWP water are significantly lower than in CRA water, but the timing of supply availability and total dissolved solids (TDS) concentrations can vary in response to hydrologic conditions. Additionally, salinity concentrations vary in the short term in response to seasonal and tidal flow patterns. MWD requires lower salinity SWP water to blend with CRA water to meet salinity requirements for its member agencies. MWD's blended salinity objective is 500 mg/L.

Environmental constraints also impact MWD's ability to meet its salinity objective. Since 2007, pumping operations in the Bay-Delta have been limited to prevent environmental harm (as discussed in the Bay-Delta Issues subsection below). MWD must rely on higher salinity CRA water resulting in an exceedance in MWD's salinity objective at times.

SWP salinity concentrations as specified in the SWP Water Service Contract have not been met. Article 19 of SWP Water Service Contract specifies ten-year average

salinity concentrations of 220 mg/L and a monthly maximum of 440 mg/L. MWD is working with DWR and other agencies to reduce salinity in SWP Bay-Delta supplies through multiple programs. These programs include modifying agricultural drainages and completing basin plans on the San Joaquin River, modifying levees around flooded islands in the Bay-Delta, and installing gates to reduce transportation of salts from seawater.

#### 8.1.2.4 Bay-Delta Issues

The Bay-Delta is a major waterway at the confluence of the Sacramento and San Joaquin rivers serving multiple and at times conflicting purposes exacerbated during dry years when water to meet the needs of both people and the environment is in short supply. Approximately two-thirds of Californians receive at least a portion of their water from the Bay-Delta. Almost all water delivered via the SWP to Southern California must pass through the Bay-Delta. Runoff from more than 40 percent of the state is also conveyed through the Bay-Delta forming the eastern edge of the San Francisco bay's estuary. A large portion of the Bay-Delta region lies below sea level and is protected by more than 1,100 miles of levees to prevent flooding. Deterioration of the Bay-Delta ecosystem coupled with infrastructure concerns, hydrologic variability, climate change, litigation, regulatory restrictions, and previously discussed water quality issues have resulted in supply reliability challenges for SWP contractors who depend upon the Bay-Delta for water supplies.

#### Environmental

As an estuarine environment, the Bay-Delta provides habitat for migratory and resident fish and birds, including those placed on the threatened or endangered species list under the federal or California Endangered Species Act (ESA). Five fish species residing in the Bay-Delta were

listed as endangered under the ESA, and one additional species was listed as threatened in 2009 under the California ESA. As a result of a combination of lawsuits regarding the ESA listed species and biological opinions and incidental take permits (permits for inadvertently harming ESA listed species) from the U.S. Fish and Wildlife Service and National Marine Fisheries Service, SWP exports and pumping operations in the Bay-Delta have been significantly curtailed. However, DWR prepared a Water Allocation Analysis in 2010 indicating that MWD could receive 150 to 200 TAF less water than forecast for 2010 under average hydrologic conditions. Ongoing litigation, additional species listing, and regulations could further curtail pumping operations and have an additional adverse impact on MWD's supplies and reserves. MWD has filed a lawsuit in conjunction with other SWP contractors challenging one of the biological opinions. As discussed below under the Delta Plan, the Delta Vision process is designed to develop long term solutions to these issues.

#### Infrastructure

Bay-Delta channels are constrained by a levee system to protect below sea level islands in the Bay-Delta from flooding. Land in the Bay-Delta subsides mainly from ongoing oxidation of aerated peat soils. Some islands are presently twenty feet or more below sea level. Land subsidence is expected to continue which increases the risk of levee failure and island flooding. Many of the levees are old and do not meet modern engineering standards. A catastrophic earthquake could cause widespread levee failure shutting down SWP operations for an extended period of time. Following a levee failure, the flow of water onto an island can pull saline water from the San Francisco Bay into the central Bay-Delta area and, if coupled with pumping in the south Bay-Delta, draw saline water into the south Bay-Delta area. Therefore, pumping in the south Bay-Delta may need to be stopped or slowed down for an extended period, and additional flows may



Photo courtesy of The Metropolitan Water District of Southern California.

need to be released from Lake Oroville to flush saline water out of the Bay-Delta. Any salinity introduced into Bay-Delta may also impact Bay-Delta water quality for an extended period of time.

Recognizing the need for protecting these vulnerable Bay-Delta levees, the Bay-Delta Levees Program was formed to coordinate improvements to and maintenance of the Bay-Delta levees. Over the next few years, the DWR and other agencies will conduct a Comprehensive Program Evaluation. This program will supplement existing risk studies, develop a strategic plan, recommend priorities, and provide estimates for the Bay-Delta Levees Program.

### 8.1.2.5 Delta Plan

Former California Governor Arnold Schwarzenegger established the Delta Vision Process in 2006 to address ongoing Bay-Delta conflicts through long-term solutions. The independent Blue Ribbon Task Force completed their vision for sustainable management of the Bay-Delta in 2008. After delivery of the Delta Vision recommendations and goals, the State Legislature initiated the process to conduct information hearings and draft legislation. Ultimately, the Governor called the Seventh Extraordinary Session to address the Bay-Delta and water issues in the State. Resulting legislation included

the approval of SB 1 X7 addressing Bay-Delta policy reforms and governance of the Bay-Delta.

A key concept of SB 1 X7 is the formation of a Delta Stewardship Council (Council). The Council is an independent State agency tasked to equally further the goals of Delta restoration and water supply reliability. One of the Council's first major tasks is to develop, adopt, and begin implementation of a Delta Plan by January 1, 2012. Key requirements of the plan as summarized in the MWD RUWMP are:

- Further the coequal goals of ecosystem restoration and water supply reliability.
- Attempt to reduce risks to people, property, and State interests.
- Promote Statewide water conservation, water use efficiency, and sustainable use of water to achieve the coequal goals.
- Improvements to water conveyance/ storage and operations of such facilities to achieve the coequal goals.
- Consider including the Bay Delta Conservation Plan (BDCP) into the Delta Plan and allow the BDCP to be eligible for State funding if specific conditions are met.

The BDCP is a joint effort of State and federal fish agencies; State, Federal, and local water agencies; environmental

organizations; and other parties with the goal of providing for both improvements in water reliability through securing long-term permits to operate the SWP and species/habitat protection in the Delta. MWD is a member of the Steering Committee. An outcome of the plan will be the identification of water flow and habitat restoration actions that assist in recovery of ESA listed and sensitive species and their associated habitats in the Bay-Delta. A range of options to accomplish the outcome will be carried forward to the environmental review phase.



Photo courtesy of The Metropolitan Water District of Southern California.

### 8.1.3 In-Basin Storage

In basin-storage facilities play a key role in maintaining MWD's reliability during droughts or other imported water curtailments and emergency outages. In-basin storage facilities consist of surface reservoirs and contracted groundwater basin storage. Conjunctive use of surface reservoirs and groundwater basins was first initiated by MWD in the 1950's. Long term storage goals for in-basin storage facilities were established in MWD's Water Surplus and Drought Management Plan (WSDM). The WSDM plan allows storage for hydrology variances, water quality, and SWP and CRA issues.

MWD has established emergency in-basin storage requirements based on a major earthquake that could potentially cutoff

all supplies for six months from the all aqueducts serving the region, the CRA, both SWP branches, and LADWP's LAA. Under this scenario, MWD would maintain deliveries by suspending interruptible deliveries, implementing mandatory water use reductions of 25 percent of normal-year demands, water would be made available from surface reservoir and groundwater supplies stored as part of MWD's interruptible supply program, and full local groundwater production would occur. MWD's emergency storage requirement is a function of projected demands and varies with time.

#### 8.1.3.1 Surface Reservoirs

MWD owns and operates seven in-basin surface storage reservoirs. Four of the reservoirs, Live Oak, Garvey, Palos Verdes, and Orange County, are used for regulatory purposes and do not provide drought or emergency storage. Additionally, MWD owns and operates two reservoirs, Copper Basin and Gene Wash, along the CRA outside of the basin for system regulation purposes. Outside its basin, MWD has 1.45 MAF storage rights in Lake Mead on the Colorado River pursuant to its intentionally created surplus agreement with the U.S. Bureau of Reclamation. MWD also has storage rights in DWR's SWP terminal reservoirs, Lake Perris and Castaic Lake, as previously discussed. The total capacity of all in-basin surface reservoirs, inclusive of the rights in the terminal reservoirs, is 1.26 MAF, as listed in Exhibit 8L.

MWD operates its three main storage reservoirs, Diamond Valley Lake, Lake Skinner and Lake Matthews, for dry-year, emergency, and seasonal storage. MWD has identified a dry-year storage capacity goal of 620 TAF by 2020. To date, this goal has been met and will be sustained with storage at Diamond Valley Lake and the two terminal reservoirs. Under an average year scenario for 2035 (1922-1994 hydrology), 576 TAF per year

## Exhibit 8L MWD's In-Basin Surface Reservoir Capacity

Reservoir	Capacity (AF)
<i>Dry Year/Emergency/Seasonal Storage Purposes</i>	
Diamond Valley Lake	810,000
Lake Matthews	182,000
Lake Skinner	44,000
Lake Perris (Storage Rights) <sup>1</sup>	65,000
Castaic Lake (Storage Rights) <sup>1</sup>	153,940
Subtotal	1,254,940
<i>Regulatory Purposes</i>	
Live Oak	2,500
Garvey	1,600
Palos Verdes	1,100
Orange County	212
Subtotal	5,412
<b>Total Reservoir Capacity</b>	<b>1,260,352</b>

1. MWD holds storage rights for flexible use in DWR terminal storage facilities, Lake Perris and Castaic Lake. In addition, MWD has emergency storage of 334 TAF in DWR's reservoirs.

of in-basin surface storage is projected to be available, exclusive of emergency supplies, as summarized in Exhibit 8M.

MWD reserves a portion of its in-basin surface reservoir storage capacity for emergencies. MWD's emergency surface reservoir storage portfolio is split between storage in its three main reservoirs and DWR reservoirs. MWD's emergency storage capacity, based on demands for 2030, is forecast to be approximately 610 TAF. Approximately 276 TAF is projected to be stored in MWD's facilities and the balance of 334 TAF in DWR's facilities. The balance of available storage capacity, 975 TAF, is for dry-year and seasonal storage.

Any additional reservoir capacity is used for seasonal storage and system operations. Seasonal storage is required to meet peak demands. MWD incorporates reserves of 5 percent into reservoir operations to account for imported water transmission infrastructure maintenance that would restrict or temporarily halt imported water flows.

## Exhibit 8M MWD Forecast Supplies of In-Basin Surface Storage Supplies in 2035, Average Year (1922 - 2004 Hydrology)

Program	Supply (Thousands of AF)/Year
In-Basin Surface Storage (Diamond Valley Lake, Lake Skinner, Lake Matthews)	444
Lake Perris and Castaic Lake MWD Storage Rights	132
<b>Maximum MWD Supply Capability</b>	<b>576</b>

Source: 2010 Regional Urban Water Management Plan, Metropolitan Water District of Southern California

## 8.1.3.2 Contracted Groundwater Basin Storage

To improve reliability, MWD engages in contracted groundwater basin storage within the basin area. By 2020, MWD aims to develop an annual dry supply of 300 TAF. To meet this goal, MWD has worked with local water agencies to increase groundwater storage. Groundwater storage occurs using the following methods:

- Direct delivery – Water is delivered directly by MWD to local groundwater storage facilities through the use of injection wells and spreading basins.
- In-lieu delivery – Water is delivered directly to a member agency's distribution system and the member agency uses the delivered water and forgoes pumping allowing water to remain in storage.

MWD engages in three main types of storage programs: replenishment,

cyclical, and conjunctive use. These programs are designed to deliver water to agencies prior to the actual need for the demands, allowing MWD to store supplies for use in dry years. Since 2007, MWD has used these programs to address SWP shortages. MWD provides financial incentives and funding to assist agencies to assist with developing storage programs.

Replenishment programs provide water to agencies at a discounted cost and can be withdrawn by the recipient after one year. Cyclic storage contracts allow surplus imported water to be delivered for recharge in advance of the actual water purchase. The delivered water is in excess of an agency's planned and budgeted deliveries. The agency purchases the water at a later time when it has a need for groundwater replenishment deliveries.

Conjunctive use contracts allow MWD to request an agency to withdraw previously stored MWD water from storage during dry periods or emergencies. Agencies

must pay MWD the current water rate when they are requested to withdraw water from storage. Water withdrawn from storage allows MWD to temporarily curtail deliveries by an equal amount. MWD currently has ten conjunctive use programs with a combined storage capacity of 421.9 TAF and a dry-year yield of 117.3 TAF per year as summarized in Exhibit 8N.

MWD prepared a Groundwater Assessment Study in 2007 in conjunction with local agencies and groundwater basin managers. As indicated in the report, there is substantial groundwater storage available in the basin, but there are multiple challenges that must be met to utilize the identified storage. Challenges include infrastructure limitations, contamination, legal issues, and funding.

To further increase the availability of in-basin groundwater storage, MWD has identified nine potential storage programs in the basin and an additional two

### Exhibit 8N In-Basin Conjunctive Use Programs

Program	Storage Capacity (Thousands of AF)	Dry-Year Yield (Thousands of AF/Year)	Balance 12/31/09 (Thousands of AF)
Los Angeles County			
Long Beach Conjunctive Use Project	13	4.3	6.4
Foothill Area GW Storage Project	9	3	0.6
Long Beach Conjunctive Use Project: Expansion in Lakewood	4	1.2	0
City of Compton Conjunctive Use Program	2	0.8	0
Upper Claremont Heights Conjunctive Use	3	1	0
Orange County			
Orange County GW Conjunctive Use Program	66	22	8.6
San Bernardino County			
Chino Basin Programs	100	33	23
Live Oak Basin Conjunctive Use Project	3	1	0.7
Riverside County			
Elsinore Groundwater Storage Program	12	4	0
Ventura County			
North Las Posas Groundwater Storage Program	210	47	43.5
<b>Total</b>	<b>421.9</b>	<b>117.3</b>	<b>84.6</b>

Source: 2010 Regional Urban Water Management Plan, Metropolitan Water District of Southern California



**Exhibit 80**  
**MWD Forecast Supplies of In-Basin Groundwater Storage in 2035,**  
**Average Year (1922 - 2004 Hydrology)**

<b>Program</b>	<b>Supply (Thousands of AF/Year)</b>
Current	
Conjunctive Use	115
Cyclic Storage	139
LADWP Tujunga Well Field Groundwater Recovery Project	12
Subtotal of Current Programs	266
Programs Under Development	
Raymond Basin Conjunctive Use	22
Subtotal of Programs Under Development	22
<b>Maximum MWD Supply Capability</b>	<b>288</b>

Source: 2010 Regional Urban Water Management Plan, Metropolitan Water District of Southern California

programs are under development. The Raymond Basin Conjunctive Use Program and the LADWP Groundwater Recovery Project are expected to add an additional 34 TAF per year in 2035 under an average year (1922 – 2004 hydrology).

In 2009, a reconnaissance-level analysis was prepared for analyzing the potential for using recycled water as a supply source for a conjunctive use program. The study concluded up to 100 TAF of groundwater storage and production could be potentially developed in four major groundwater basins using Los Angeles County Department of Sanitation supplies. MWD initiated a formal study in 2010 to further study. This concept along with the potential to use City of Los Angeles recycled water supplies from the Hyperion Wastewater Treatment Plant as an additional source.

Exhibit 80 provides a summary of forecast groundwater storage supplies available in 2035 under an average year (1922 -2004 hydrology). Approximately 289 TAF per year are forecast to be available.

### 8.1.4 Groundwater Storage and Water Transfers

MWD engages in groundwater storage outside of the basin and water transfers to increase the reliability of SWP dry-year supplies. Groundwater storage and water transfers were initiated by MWD in response to concerns that MWD’s supply reliability objectives could not be met by the SWP. Groundwater storage and transfer programs were developed to allow MWD to reach its SWP reliability goal. All groundwater storage and water transfer programs designed to bolster SWP reliability are located within the vicinity of the SWP or Central Valley Project (CVP) facilities to facilitate the ultimate deliver of water to MWD. Groundwater storage programs involve agreements allowing MWD to store its SWP contract Table A water in excess of MWD demands and to purchase water for storage. MWD calls for delivery of the stored water during dry years. Transfers involve purchases by MWD from willing sellers during dry years when necessary.

**Exhibit 8P**  
**MWD Forecast Supplies of Groundwater Storage and Transfers in 2035, Average Year (1922 - 2004 Hydrology)**

Program	Supply (Thousands of AF/Year)
Current	
San Bernardino Valley MWD Minimum Purchase	20
San Bernardino Valley MWD Option Purchase	29
Central Valley Storage and Transfers	
Semitropic Water Banking and Exchange Program	69
Arvin-Edison Water Management Program	75
San Bernardino Valley MWD Program	50
Kern Delta Water Management Program	50
<b>Subtotal of Current Programs</b>	<b>293</b>
Programs Under Development	
Mojave Groundwater Storage Program	43
North of Delta/In-Delta Transfers	33
San Bernardino Valley MWD Central Feeder	5
Shasta Return	18
Semitropic Agricultural Water Reuse	11
<b>Subtotal of Proposed Programs</b>	<b>110</b>
<b>Maximum Supply Capability</b>	<b>403</b>

Source: 2010 Regional Urban Water Management Plan, Metropolitan Water District of Southern California

Exhibit 8P summarizes MWD's out of basin groundwater storage and transfer programs supplies in 2035, under an average year (1922 – 2004 hydrology). Current programs are expected to deliver 293 TAF in 2035. Five programs under development are forecasted to deliver an additional 110 TAF for a total of 403 TAF in 2035.

### 8.1.4.1 Groundwater Storage

MWD has four Central Valley groundwater storage programs with a fifth program under development as described below.

The Semitropic Water Banking and Exchange Program is a partnership formed in 1994 between Semitropic Water Storage District (SWSD), MWD, and five other banking partners. The bank has a total storage capacity of 650 TAF, of which MWD has 350 TAF of storage

volume. During years of excess SWP deliveries, beyond MWD's demands, a portion of MWD's SWP entitlement water is stored for withdrawal during dry years. Deliveries for storage are transferred via SWP facilities for direct use by agricultural users that in turn forgo pumping an equal volume of water. In dry years, water is pumped from storage to SWP facilities for delivery to MWD or entitlements are exchanged. MWD's average annual supply capability for a dry year (1977 hydrology) is 125 TAF and for multiple dry years (1990 – 1992 hydrology) is 107 TAF. By the end of 2009, MWD had 45 TAF in storage.

Since 1997, MWD has had an agreement with Arvin-Edison Water Storage District to use 350 TAF of storage in its groundwater basins. The agreement was amended in 2008 to include the South Canal Improvement project to deliver higher quality water to MWD. During wet years, MWD delivers SWP water in excess of its demands for storage and receives return water in dry years in a similar

manner as the Semitropic program, except a combination of SWP and CVP facilities are used to transfer the water and water can be stored by a combination of direct spreading or in lieu use by agricultural users. MWD's average supply capability is 75 TAF for either a single dry year (1977 hydrology) or multiple dry years (1990 – 1992 hydrology). In 2009, MWF had 95 TAF in storage.

The San Bernardino Municipal Water District Program (SBMWD) allows for the purchase and storage of SWP water on behalf of MWD. MWD has a minimum purchase agreement with SBMWD of 20 TAF per year of SBMWD's SWP Table A amount. Additionally, MWD has the option to purchase SBMWD's additional SWP allocation when available and the first right-of-refusal to purchase additional SWP supplies available to SBMWD beyond the minimum and option agreements. If MWD does not require the minimum purchase amount for operations, MWD can store up to 50 AF for future use in dry years within SBMWD's groundwater basins. Water is delivered to MWD via SWP facilities and groundwater pumping conveyed through local connections to MWD's service area. MWD's average annual supply capability for a dry year (1977 hydrology) is 70 TAF and for multiple dry years (1990 – 1992 hydrology) is 37 TAF. By the end of 2009, MWD had no water in storage and deliveries have been suspended upon a mutual agreement between MWD and SBMWD.

MWD entered into an agreement with the Kern Delta Water District (Kern-Delta) for the Kern-Delta Water Management Plan in 2001 to allow up to 250 TAF of groundwater storage. During wet years MWD delivers SWP water in excess of its demands for storage and receives return water in a similar manner as the Semitropic program, except the water can be stored by direct recharge or in lieu use by agricultural users. Per terms of the agreement, MWD can potentially store beyond 250 TAF. In dry years, water is pumped from storage to SWP facilities for delivery to MWD or entitlements are exchanged. When the project is completed

50 TAF per year of dry year supply can be withdrawn. At the close of 2009, MWD had 10 TAF in storage and expects to fully withdraw the amount in 2010.

The Mojave Groundwater Storage Program is currently a demonstration project between MWD and Mojave Water Agency. Similar to the other groundwater storage programs, MWD's excess SWP water will be stored during wet years for withdrawal during dry years. When fully operational, the program is expected to have a dry year yield of 35 TAF.

### 8.1.4.2 Transfers

MWD utilizes Central Valley water transfers to obtain additional supplies originally destined for agricultural users on an as needed basis. Past transfer agreements have used both spot markets and option contracts. Spot markets occur when there are willing sellers and buyers. Option contracts lock-in MWD's ability to have the option to purchase supplies if needed. Additionally, MWD has multiple long-term transfer programs under

#### Exhibit 8Q MWD Historic Central Valley Water Transfers

Program	Purchases by MWD <sup>1</sup> (AF/Year)
1991 Governor's Water Bank	215,000
1992 Governor's Water Bank	10,000
1994 Governor's Water Bank	100
2001 Dry Year Purchase Program	80,000
2003 MWD Transfer Program	126,230
2005 State Water Contractors Water Transfer Program <sup>2</sup>	0
2008 State Water Contractors Water Transfer Program	26,621
2009 Governor's Water Bank	36,900

1. Transfers requiring use of Bay-Delta result in a water loss of 20 percent. Transfers requiring the California Aqueduct for delivery to MWD's service area result in a 3 percent water loss.

2. 127,275 in options were secured, but not needed.

Source: 2010 Regional Urban Water Management Plan, Metropolitan Water District of Southern California

development. MWD's ability to conduct transfers and the amount of water to be transferred using SWP facilities are a function of hydrologic conditions, market conditions, and pumping restrictions in the Bay-Delta region. Transfers may require the use of the Bay-Delta for conveyance dependent upon the origin of the water. Historic transfers, as listed in Exhibit 8Q, indicate MWD is capable of negotiating contracts with agricultural districts and the State's Drought Water Bank to obtain transfers. MWD also has demonstrated it can work with DWR and

the U.S. Bureau of Reclamation (USBR). Cooperation of both agencies is required as transfers use a combination of DWR's SWP and USBR's CVP facilities. Transfers from north of the Bay-Delta result in the loss of 20 percent of the water during conveyance while transfers via the California Aqueduct to MWD's service area result in the loss of 3 percent water during conveyance. During dry years and when pumping capacity in the Bay-Delta is available, MWD expects to be able to transfer 125 TAF through SWP facilities.

### Exhibit 8R MWD System Forecast Supplies and Demands, Average Year (1922 - 2004 Hydrology)

Forecast year	Supply (Thousands of AF per Year)				
	2015	2020	2025	2030	2035
Current Programs					
In-Basin Surface Reservoir and Groundwater Storage	685	931	1,076	964	830
State Water Project <sup>1</sup>	1,550	1,629	1,763	1,733	1,734
Colorado River Aqueduct					
Colorado River Aqueduct Supply <sup>2</sup>	1,507	1,529	1,472	1,432	1,429
Aqueduct Capacity Limit <sup>3</sup>	1,250	1,250	1,250	1,250	1,250
Colorado Aqueduct Capability	1,250	1,250	1,250	1,250	1,250
<b>Capability of Current Programs</b>	<b>3,485</b>	<b>3,810</b>	<b>4,089</b>	<b>3,947</b>	<b>3,814</b>
Demands					
Firm Demands on MWD	1,826	1,660	1,705	1,769	1,826
Imperial Irrigation District - San Diego County Water Authority Transfers and Canal Linings <sup>4</sup>	180	273	280	280	280
<b>Total Demands on MWD</b>	<b>2,006</b>	<b>1,933</b>	<b>1,985</b>	<b>2,049</b>	<b>2,106</b>
<b>Surplus</b>	<b>1,479</b>	<b>1,877</b>	<b>2,104</b>	<b>1,898</b>	<b>1,708</b>
Programs Under Development					
In-Basin Surface Reservoir and Groundwater Storage	206	306	336	336	336
State Water Project <sup>1</sup>	382	383	715	715	715
Colorado River Aqueduct					
Colorado River Aqueduct Supply	187	187	187	182	182
Aqueduct Capacity Limit <sup>2</sup>	0	0	0	0	0
Colorado Aqueduct Capability	0	0	0	0	0
<b>Capability of Programs Under Development</b>	<b>775</b>	<b>876</b>	<b>1,238</b>	<b>1,233</b>	<b>1,233</b>
<b>Maximum MWD Supply Capability</b>	<b>4,260</b>	<b>4,686</b>	<b>5,327</b>	<b>5,180</b>	<b>5,047</b>
<b>Potential Surplus</b>	<b>2,254</b>	<b>2,753</b>	<b>3,342</b>	<b>3,131</b>	<b>2,941</b>

1. Includes water transfers and groundwater banking associated with SWP.

2. Includes 296 TAF of non-MWD supplies conveyed in CRA for Imperial Irrigation District - San Diego County Water Authority Transfers and Canal Linings.

3. CRA has a capacity constraint of 1.25 MAF per year.

4. Does not include 16 TAF subject to satisfaction of conditions specified in agreement among MWD, the US, and the San Luis Rey Settlement

Source: 2010 Regional Urban Water Management Plan, Metropolitan Water District of Southern California

## 8.2 MWD Supply Reliability and Projected LADWP Purchases

---

MWD's 2010 Integrated Water Resources Plan (IRP) update serves as the foundation for supply forecasts discussed in the RUMWP and continues to ensure system reliability for its member agencies. The 2010 IRP update concluded that the resource targets identified in previous updates, taking into consideration changed conditions identified since that time, will continue to provide for 100 percent reliability through 2030. MWD's subsequent evaluation to extend the resource targets by an additional five years through their 2010 draft RUMWP also concluded the same full reliability during average (1922 – 2004 hydrology), single dry (1977 hydrology), and multiple dry years (1990 – 1992 hydrology). For each of the scenarios, there is a surplus in every forecast year. Exhibit 8R summarizes MWD's reliability in five year increments extending to 2035.

The City purchases MWD water to make up the deficit between demand and other City supplies. Whether LADWP can provide reliable water services to the residents of Los Angeles is highly dependent on MWD's assurance on supply reliability. However, the recent water supply shortage caused by dry weather and pumping restrictions in the Bay-Delta prompted the City to develop a more sustainable water supply portfolio with emphasis on local water supplies such as recycled water, groundwater cleanup, stormwater capture, and conservation. LADWP's reliance on MWD water supply is projected to be cut in half from the current five-year average of 52 percent of the total demand to 24 percent by 2034-35 under average weather conditions.

The reliability of MWD's water supply is more fully discussed in Chapter 10, Integrated Resources Planning. The projected LADWP water purchase is further discussed in Chapter 11, Water Service Reliability Assessment under various weather scenarios.

## 8.3 MWD Rate Structure and LADWP's Purchased Water Costs

---

### 8.3.1 MWD Rate Structure

---

MWD's rates are structured on a tier-based system with two tiers and a surplus category. Nine major elements determine the actual price a member agency will pay for deliveries. All of the elements are volumetric based except for two fixed rates, the Readiness-to Serve Charge and the Capacity Charge.

Tier 1 rates are reflective of actual costs of existing supplies and are designed to recover most of the supply costs. Member agencies are allocated a specified volume of Tier 1 water that can be purchased within a given year. In 2011, LADWP's Tier 1 limit is 304,970 AF. Any purchases above this are charged at the Tier 2 rate. MWD has instituted a temporary Bay-Delta surcharge to recover costs associated with lower SWP deliveries related to pumping restrictions. The surcharge will remain in effect until SWP yields improve.

Tier 2 rates send a price signal associated with MWD's costs of developing additional long-term firm supply options. Member agencies with growing demands on MWD will have a higher proportion of deliveries within the Tier 2 range.

Surplus water is water in excess of consumptive municipal and industrial demands. Surplus water is available at two discounted levels dependent upon the end use. Replenishment Program water is discounted for replenishing local agency supplies. The program has been suspended as a result of dry conditions and uncertain future supplies. The Interim Agricultural Water Program (IAWP) provides discounted water for agricultural use. This program is being phased out and will terminate beginning in 2013.

## Exhibit 8S MWD Rates and Charges

Rates and Charges	Effective Rate January 1		
	2010	2011	2012
Tier 1 Supply Rate (\$/AF)	101	104	106
Delta Supply Surcharge (\$/AF)	69	51	58
Tier 2 Supply Rate (\$/AF)	280	280	290
System Access Rate (\$/AF)	154	204	217
Water Stewardship Rate (\$/AF)	41	41	43
System Power Rate (\$/AF)	119	127	136
Full Service Untreated Volumetric Cost (\$/AF)			
Tier 1	484	527	560
Tier 2	594	652	686
Replenishment Water Untreated (\$/AF)	366	409	442
Interim Agricultural Water Untreated (\$/AF)	416	482	537
Treatment Surcharge (\$/AF)	217	217	234
Full Service Treated Volumetric Cost (\$/AF)			
Tier 1	701	744	794
Tier 2	811	869	920
Treated Replenishment Water (\$/AF)	558	601	651
Treated Interim Agricultural Water Program (\$/AF)	615	687	765
Readiness-to-Serve Charge (\$/M)	114	125	146
Capacity Charge (\$/cfs)	7,200	7,200	7,400

Source: 2010 Regional Urban Water Management Plan, Metropolitan Water District of Southern California

Exhibit 8S summarizes the rates and charges for member agencies effective on January 1 of 2010, 2011, and 2012.

### 8.3.2 LADWP's Purchased Water Costs

MWD's water rates vary from \$484 per AF of tier 1 untreated water to \$811 per AF of tier 2 treated water in 2010. The average unit cost of MWD water supply depends on the proportions of treated water and untreated water, tier 1 water, and tier 2 water purchased in a given period. From 2003 to 2009, LADWP purchased 88 percent tier 1 water and 12 percent tier 2 water, and 70 percent untreated water and 30 percent treated water on average. The tier 2 water purchase varied

from no purchase in 2005 and 2006 to 29 percent in 2007 and 2008. The treated water purchase varied from 20 percent in 2007 to 46 percent in 2005. Exhibit 8T illustrates the various combinations.

The Readiness-to-Serve Charge and Capacity Charge are predetermined fixed charges for each member agency and not affected by the quantity of MWD water purchased. However, they add on to the unit cost of the City's MWD water purchase. The City's current share of the Readiness-to-Serve Charge is 15.12 percent or \$17.24 million in 2010. The Capacity Charge is calculated based on the summer daily peak flow from the previous three years. The City's 2010 Capacity Charge is \$5.9 million based on the daily peak flow of 822 cfs in 2008 summer. Both charges added an additional \$110 per AF to the unit cost of LADWP's MWD water purchase in 2010.

**Exhibit 8T**  
**Percentage of LADWP's Purchased Water in Various MWD Rate Categories**

MWD Deliveries Calender Year	Tier 1		Tier 2		Total Tier 1	Total Tier 2	Total Untreated	Total Treated
	Untreated	Treated	Untreated	Treated				
	%	%	%	%	%	%	%	%
<b>2003</b>	73	22	4	2	95	5	76	24
<b>2004</b>	71	25	3	1	96	4	74	26
<b>2005</b>	54	46	0	0	100	0	54	46
<b>2006</b>	58	42	0	0	100	0	58	42
<b>2007</b>	56	15	25	5	71	29	80	20
<b>2008</b>	48	23	23	6	71	29	71	29
<b>2009</b>	67	20	10	3	87	13	77	23
<b>2010</b>	62	38	0	0	100	0	62	38
<b>Average</b>	61	29	8	2	90	10	69	31





## 9.0 Overview

---

LADWP continually investigates other feasible water supplies to ensure the sustainability of water supply for the City of Los Angeles. In recent years, LADWP has actively pursued and investigated various supply options including water transfers and banking and seawater desalination. Evaluating the viability of these and other water resource options is a key element to ensuring the City's future water supply reliability. Such options, with proper planning, can contribute toward fulfilling future demand under various conditions. Future water resource challenges, which include increased demand that must be met without increasing imported supply, warrant thoughtful consideration of these and other feasible water supply resources.

Following is a discussion of other water resource options as mentioned above, highlighting LADWP's progress in developing each alternative source of water. Factors that affect feasibility and influence potential implementation are also discussed, as well as advances that facilitate development of the resource option. Of the water supplies discussed in this chapter, LADWP is planning to pursue water transfers of up to 40,000 Acre-Feet (AF) by Fiscal Year 2014/15.

## 9.1 Water Transfers and Banking

---

Water transfers involve the lease or sale of water or water rights between consenting parties. Water Code Section 470 (The Costa-Isenberg Water Transfer Act of 1986) states that voluntary water transfers between water users can result in a more efficient use of water, benefiting both the buyer and the seller. The State Legislature further declared that transfers of surplus water on an intermittent basis can help alleviate water shortages, save capital outlay development costs, and conserve water and energy. This section of the Water Code also obligates the California Department of Water Resources (DWR) to facilitate voluntary exchanges and transfers of water.

DWR is required to establish an ongoing program to facilitate the voluntary exchange or transfer of water and implement the various State laws that pertain to water transfers. In response to this mandate, DWR established an internal office dedicated specifically to water transfers in June 2001 and has developed various definitions and policies for transfers. Of particular importance are the rules protecting existing water rights. Water rights cannot be lost when they are transferred to another user if the transferor has an underlying right to the

transferred water. DWR also developed three fundamental rules specifically regarding water transfers:

- There can be no injury to any legal user of water.
- There can be no unreasonable effect on fish and wildlife.
- There can be no unreasonable economic effects to the economy in the county of origin.

Water banking, a form of conjunctive use, is the storage of water in groundwater basins for future use. Typically, during wet periods water is stored or banked within groundwater basins for potential extraction during dry periods. Water banking sets up accounts to track the volumes of water recharged and extracted per terms of contract agreements between water agencies. Water banking may occur outside of a water agency's service area. If the water agency's own conveyance facilities are not directly adjacent to the water bank, stored water can be extracted and transferred through wheeling and exchange via other conveyance and storage facilities. Such movements of water involve institutional transfer agreements among water users and agencies.

### 9.1.1 LADWP Opportunities

LADWP plans on acquiring water through transfers to replace a portion of LAA water used for environmental enhancements in the eastern Sierra Nevada. The City would purchase water when available and economically beneficial for storage or delivery to LADWP's transmission and distribution system. The City is seeking non-State Water Project (SWP) water to replace the reallocation of LAA water supply for environmental enhancements. MWD holds an exclusive contractual right to deliver SWP entitlement water into its

service territory, which includes the City of Los Angeles. Purchasing only non-SWP supplies will ensure the City's compliance with MWD's SWP contract.

To facilitate water transfers, LADWP is constructing an interconnection between the LAA and the SWP's California Aqueduct, located where the two aqueducts intersect in the Antelope Valley (see photo below). This interconnection, the Neenach Pumping Station will allow for water transfers from the East Branch of the SWP to the LAA system, as well as provide operational flexibility in the event of a disruption of flows along the LAA System. Construction of the Neenach Pumping Station required a four-way agreement between DWR, MWD, LADWP, and the Antelope Valley-East Kern Water Agency (AVEK). When completed, the Neenach Pumping Station facility will be owned by DWR but will be designated as an AVEK interconnection. The Neenach Pumping Station will be operated on behalf of the LADWP. MWD is involved in the agreement to provide consent for the transferred water to enter its service territory.

LADWP's current goal is to transfer up to 40,000 AFY once the Neenach Pumping Station facilities are in place. This will provide LADWP with the ability to replace some LAA supplies that have been reallocated to environmental enhancement projects in the Mono Basin and Owens Valley. This will also provide increased operational flexibility and cost savings for LADWP customers.

A demonstration study will be performed during the Neenach Pumping Station's first two years of operations. This study will include an evaluation of the operational and water quality impacts of the Neenach Pumping Station.

To supplement water transfers, LADWP also investigated the feasibility of water banking. A request for proposal (RFP) was issued in 2008 and five proposals were received for evaluation to identify the most mutually beneficial water banking program. However, after this evaluation

Neenach Temporary Pumping Station, construction site, looking northerly, taken September 16, 2010, by Aqueduct Aerial Patrol.



process, LADWP decided to not pursue full scale water banking projects at this time.

The City supports statewide water transfer legislation that will ensure the efficient use of the State’s limited water resources and provide safeguards for the environment, public facilities, water conservation efforts and local economies. LADWP will continue to develop a responsible water transfer program that can assist in replacing City supplies that have been reallocated to the environment in the Eastern Sierra Nevada.

### 9.1.2 MWD Opportunities

Regionally, MWD has been active with water transfers and banking, seeking and implementing agreements and cooperative arrangement opportunities to supplement Southern California’s water supply. MWD’s water transfer activities are classified as *spot transfers*, *option transfers*, *core transfers*, *storage transfers*, or *exchanges*. Each activity is described briefly below.

- *Spot transfers* make water available through a contract entered into the same year that the water is delivered.
- *Option transfers*, through multi-year or single-year contracts, allow MWD to obtain water on an “as-needed” basis.
- *Core transfers* make water available through multi-year contracts that convey specific water entitlement to MWD each year.

- *Storage transfers* allow MWD to store and later recover available water that can then be transported immediately to Southern California.
- *Exchange agreements* involve the transfer to MWD of another agency's entitlements in exchange for water entitled to MWD from another source.

MWD is in the process of developing and implementing transfer/storage projects in the Central Valley, and off-stream banking and dry year supplies of Colorado River water. Water transfers, including the programs highlighted below, are an important element of California's plan to live within its 4.4 million acre-feet per year entitlement to Colorado River water. These programs have also helped MWD adjust to regulatory restrictions on State Water Project pumping from the San Francisco Bay-Delta. Current and potential MWD transfer, storage, and exchange agreements/activities include:

- Semitropic Water Storage Program
- Kern Delta Water District Water Management Program
- Arvin-Edison Water Transfer and Storage Program, Kern County
- San Bernardino Valley Transfer and Storage Program
- Desert Water Agency/Coachella Valley Water District Exchange Program
- Palo Verde Land Management, Crop Rotation, and Water Supply Program
- Hayfield Groundwater Storage Project (under development)
- Southern Nevada Water Authority and Metropolitan Storage and Interstate Release Agreement
- Central Valley Water Transfers
- Yuba Accord Dry Year Purchase Program
- Lower Colorado Water Supply Project
- Lake Mead Water Storage Program
- Drop 2 Reservoir Funding
- Arizona Exchange (under development)
- Yuma Desalter Exchange (under development)
- California Indians Exchange (under development)
- Expansion of Southern Nevada Water Authority Agreement (under development)
- ICS Exchange Program (under development)
- Expansion of Palo Verde Land Management, Crop Rotation, and Water Supply Program (under development)
- Mojave Water Agency Exchange Demonstration Program (under development)
- North of Delta/In Delta Transfers (under development)
- North Kern/Desert Water Agency Exchange (under development)
- Shasta Return Project
- Semitropic Agricultural Water Reuse Demonstration Project (under development)
- San Bernardino Valley MWD Central Feeder Project (under development)
- Chuckwalla Groundwater Storage Program (under development)
- Coachella Valley Water District Agreement (under development)

MWD's water rate structure is designed to allow water transfers using MWD infrastructure by establishing a water wheeling rate, which is a combination of the System Access Rate, Water

Stewardship Rate, System Power Rate, and if treated water is delivered, a Treatment Surcharge. This wheeling rate applies to all water conveyed through MWD's infrastructure, regardless of the agency using the system. MWD's unbundled rate structure and its associated wheeling rate encourage development of water markets by providing for competition at the supply level; MWD's member agencies can purchase supplies from any source and pay MWD's wheeling rate to transmit the water. MWD's current water rate structure establishes charges for each component on a per acre-foot basis for all water moving through MWD's system. As of January 1, 2011, current wheeling rate charges are:

- System Access Rate: \$204/AF
- Water Stewardship Rate: \$41/AF
- System Power Rate: \$127/AF
- Treatment Surcharge: \$217/AF

The System Access Rate recovers costs associated with conveyance and distribution capacity to meet average annual demands. The Water Stewardship Rate recovers the cost associated with providing financial incentives for investments in local water resources, such as water conservation and recycled water programs. The System Power Rate recovers the cost of power required to move water through MWD's system. The Treatment Surcharge applies to all water that is treated at one of MWD's five treatment plants.

MWD's water rate structure also incorporates a tiered supply rate format. The first tier price applies to a fixed base quantity of water as defined by each MWD member agency's purchase order contract. The second tier price reflects the incremental cost for MWD to acquire additional supplies that are above the first tier contract base amount.

## 9.2 Seawater Desalination

Seawater desalination, the process of removing salts and other impurities from seawater, has reached an all-time high in terms of worldwide production capacity. According to the International Desalination Association, between 2007 and 2009, worldwide seawater desalination capacity increased by approximately thirty percent to a total capacity of 9.5 billion gallons per day. This is partly driven by the fact that the cost to desalinate water has decreased significantly due to technological and process advancements. Of the more than 14,000 seawater and groundwater desalination plants in operation worldwide, the majority are located in the Middle East, where energy costs are relatively low. The world's largest seawater desalination plant in Saudi Arabia produces 232 mgd of desalted water. In contrast, the largest facility in the United States, located in Tampa Bay, FL, produces 25 mgd.

LADWP's current water resource strategy does not include seawater desalination as a water supply. There are concerns with cost and the environmental impacts associated with the implementation of desalination. LADWP is primarily focused on enhancing recycling and conservation. While desalination may be explored further in the future, it currently represents only a supply alternative.

### 9.2.1 Desalination Technology

Technology to desalt seawater to produce potable water which meets or exceeds drinking water standards has been available for some time, but has not been widely implemented primarily due to its high cost. Although the cost to desalinate seawater is still more expensive than obtaining water from conventional sources, continued research and development, as well as large scale

projects are being implemented in the United States and other parts of the world to improve technology and further drive costs down. Additionally, increasing costs associated with new water supplies and existing supplies is reducing the cost differential between desalinated water and other water sources improving the viability of desalinated water as a part of an overall water supply portfolio.

The two basic seawater desalination processes are: 1) use of the distillation process to evaporate water from salts; and 2) use of semi-permeable membranes to filter the water while straining out the salts. While distillation has been the dominant seawater desalination technology (primarily in the Middle East), current worldwide desalination development is rapidly migrating toward membrane technology. Facilities using distillation are still prevalent in the Middle East. However, new plant installations are increasingly taking advantage of technological advancements (higher yield and lower energy requirements) in membrane-based process technology. Today, membrane filtration accounts for over half of the world's desalting capacity.

### 9.2.2 DWR Desalination Efforts

Recognizing the potential of seawater as a water resource, the DWR through a legislative mandate, convened a California Water Desalination Task Force in 2002. The task force was responsible for making recommendations to the State Legislature on potential opportunities, impediments, and the State's role in furthering desalination technology.

The task force was effective in providing a forum in which stakeholders could convene and discuss critical issues related to desalination. Key seawater desalination issues that have been raised

through the task force fall into six general categories: environmental, economic, permitting, engineering, planning, and coordination.

To assist in addressing these issues, the California Water Desalination Task Force has developed draft guidelines for developing environmentally and economically acceptable desalination projects. These include the following:

- Each project should be considered on its own merits.
- Sponsoring agencies should be determined early in the planning process.
- Public and permitting agencies should be engaged early in the planning process.
- Collaborative processes should be used to enhance support for project implementation.
- A feedback loop should be incorporated to allow for continuously revisiting and revising the project at each step of the planning process.
- Key decision points (e.g., costs, environmental acceptability) should be identified to test the general feasibility of the project as early in the planning process as possible.

After establishment of the task force, desalination was added to the California State Water Plan as an alternative for consideration in regional water supplies. Furthermore, in 2008, DWR published the *California Desalination Planning Handbook*, building upon the task force's efforts. The handbook provides guidance on determining appropriate conditions for desalination plants, addressing concerns, and building public trust.

Proposition 50, Chapter 6, has provided funding for desalination research, feasibility studies, pilot projects, and construction of new facilities. Over \$45 million was distributed under this

proposition in two rounds of funding for both seawater and groundwater desalination. Fund recipients included LADWP.

With increasing demand for water and limited new supply options, the future value of seawater desalination as a part of California's water supply portfolio has become apparent. Within Southern California, a range of 270,000 AFY to 422,000 AFY of desalinated seawater could be potentially produced based on current efforts (see Exhibit 9A). While this production represents less than five percent of the region's total water supplies, it is nonetheless considered by water planners as an important part of the region's water supply portfolio.

### **9.2.3 MWD Desalination Efforts**

---

MWD first incorporated desalinated seawater as a potential new water supply source in its 2003 Integrated Resources Plan Update. Subsequently in 2009, MWD's Board of Directors created a special committee on Desalination and Recycling to study MWD's role in regional efforts to develop desalination facilities.

In response to a proposal solicitation in 2001, MWD received proposals by five member agencies to provide up to 142,000 AFY of potable water. To provide an incentive for the development of desalinated seawater, MWD is offering subsidies of up to \$250 for each acre-foot (326,000 gallons) of desalinated seawater produced. LADWP, Long Beach Water Department (LBWD), West Basin Municipal Water District (WBMWD), Municipal Water District of Orange County, and San Diego County Water Authority (SDCWA) submitted detailed proposals that qualified for the MWD's Seawater Desalination Program. Exhibit 9A summarizes the status of the desalination efforts in MWD's service area, including projects not in the Seawater Desalination Program. Each of

these agencies serves coastal areas, and is looking to desalination as a means to further diversify its water supply portfolio.

### **9.2.4 LADWP Seawater Desalination Efforts**

---

#### **Scattergood Generating Station Seawater Desalination Plant**

LADWP initiated efforts in 2002 to evaluate seawater desalination as a potential water supply source with the goals of improving reliability and increasing diversity in its water supply portfolio. These efforts led to the selection of Scattergood Generating Station as a potential site for a seawater desalination plant. For the City, seawater desalination is a potential resource that could also offset supplies that had been committed from the LAA for environmental restoration in the eastern Sierra Nevada. As an identified project in MWD's Seawater Desalination Program, the proposed full-scale project would have qualified for MWD's grant of \$250 per AF of water produced. However, in May 2008, LADWP decided to focus on water conservation and water recycling as the primary strategies in creating a sustainable water supply for the City.

While seawater desalination is not a potential water supply strategy at this time, studies performed to date have provided beneficial data that in the future can assist LADWP with any future evaluations of seawater desalination. Completed studies include the LADWP Proposed Seawater Desalination Plant Site Selection Fatal Flaw Analysis (2002), LADWP Seawater Desalination Facility Feasibility Study for the Scattergood Generating Station in Playa Del Rey (2004), Brine Dilution Study for the LADWP Desalination Project at Scattergood Generating Station (2005), and Scattergood Seawater Desalination Pilot Project Preliminary Evaluation Report (2008).

**Exhibit 9A**  
**Desalination Efforts in MWD Service Area**

Project Name	Member Agency	Capacity (AFY)	Status
<b>MWD Seawater Desalination Program</b>			
Long Beach Seawater Desalination	Long Beach	10,000	Pilot Study <sup>1</sup>
Los Angeles Seawater Desalination	LADWP	28,000	On-hold
South Coast Coastal Ocean Desalination	Municipal Water District of Orange County	16,000 - 28,000	Pilot Study
Carlsbad Seawater Desalination	San Diego County Water Authority	56,000	Permitting Complete
West Basin Seawater Desalination	West Basin Municipal Water District	20,000	Pilot Study <sup>1</sup>
Subtotal		130,000 - 142,000	
<b>Other Potential Projects in MWD Service Area</b>			
Huntington Beach Seawater Desalination	Municipal Water District of Orange County	56,000	Initiating Permitting
Camp Pendleton Seawater Desalination	San Diego County Water Authority	56,000 - 168,000	Planning
Rosarito Beach Seawater Desalination	San Diego County Water Authority	28,000 - 56,000	Feasibility Study
Subtotal		140,000 - 280,000	
Total		270,000 - 422,000	

1. Full scale feasibility studies in progress.

Source: Annual Progress Report to the State Legislature, Achievements in Conservation, Recycling, and Groundwater Recharge, February 2010.



To determine the proper site location for a City desalination plant, LADWP conducted the LADWP Proposed Seawater Desalination Plant Site Selection Fatal Flaw Analysis evaluating three City-owned coastal power generating plants. Based on the findings from this analysis, LADWP initially decided to investigate development of a 12 to 25 mgd desalination facility at the Scattergood Generating Station.

Optimum capacity of a future desalting facility at the Scattergood Generating Station was evaluated in the LADWP Seawater Desalination Facility Feasibility Study. Results of the study indicated a 25 mgd facility would be the most economical. Estimated capital costs for a 25 mgd facility were approximately \$148.5 million in 2004 dollars with an annual operations and maintenance cost of \$28.9 million (2004 dollars) resulting in a total water cost of approximately \$1,257 per AF. The study also identified the five-mile Hyperion Treatment Plant Outfall, which is adjacent to the Scattergood Generating Station, as the most environmentally advantageous method to dispose of the brine concentrate produced from the desalting process.

In an effort to develop an environmentally compatible project, LADWP evaluated the feasibility of discharging the desalted concentrate into Hyperion Wastewater Treatment Plant's 5-mile outfall. The Brine Dilution Study for the LADWP Desalination Project at Scattergood Generating Station performed by the Scripps Institute of Oceanography found that there are potential environmental benefits to the Santa Monica Bay's marine biology due to improved salt balance if the effluent discharged by the Hyperion Wastewater Treatment Plant were to include brine from a desalination facility.

In March 2008 the Preliminary Evaluation Report of the Scattergood Generation Station Seawater Desalination Pilot Project was completed. This was the first task of multiple tasks that was to ultimately result in the operation of a pilot plant. Co-funded by the US Bureau

of Reclamation and DWR through Proposition 50 funding the overall goal was to further investigate the viability of seawater desalination for LADWP. Recommendations on site specific technologies and processes were provided for carry over to the pilot plant design stage. Items for further study included subsurface intake evaluation, cooling alternatives for warm water, second pass reverse osmosis, post treatment stabilization, and finished water blending strategy.

After completion of the first task, the other tasks were not initiated reflecting the City's new primary strategies of conservation and recycled water to create a sustainable water supply for the City. Studies completed to date and LADWP's other seawater desalination efforts discussed below have provided important data that could assist LADWP if the decision is made to move forward with seawater desalination in the future.

### **Other LADWP Seawater Desalination Efforts**

LADWP historically engaged in multiple partnerships to advance seawater desalination in Southern California. Seawater desalination is hindered by multiple challenges including, but not limited to, capital costs, operating costs, environmental considerations, water quality, and public acceptance. To overcome these challenges, LADWP has supported efforts to lower the capital and operating costs of producing desalinated ocean water. LADWP also participated with California stakeholders through multiple venues, such as the MWD and the California Water Desalination Task Force to develop desalination study projects within Southern California.

LADWP, LBWD, and the United States Bureau of Reclamation partnered in the construction of a 300,000 gpd prototype seawater desalination facility to complete testing of LBWD's proprietary two-stage nanofiltration process (using membranes that require lower operating pressures and thus, the potential for lower operating

costs). LBWD successfully performed a 9,000-gpd bench-scale testing of this technology and began testing on a larger scale in October 2006 at LADWP’s Haynes Generating Station in Long Beach. In March 2010, LBWD completed its testing and subsequently prepared the final report.

LADWP also partnered with the WBMWD and other agencies in the American Water Works Association Research Foundation Tailored Collaboration project, “Water Quality Implications for Large-Scale Applications of MF/RO Treatment for Seawater Desalination.” A 30,000-gpd pilot facility operating off the coast of El Segundo, California, from 2002 to 2008, was tested for membrane performance, water quality, and operational cost.

In a joint study by LADWP, LBWD, and WBMWD, preliminary sampling of raw seawater quality was initiated at three potential seawater desalination sites - Scattergood Generating Station in Playa Del Rey, Haynes Generating Station in Long Beach, and El Segundo Power Generating Station. Water quality analysis on the seawater was

performed at various times of the year to analyze seawater quality variations during storm events when city surface runoffs drain into the ocean. The next step would be to collaborate with the California Department of Health Services on developing guidelines to ensure that product water from future desalting facilities will meet all State and Federal water quality regulations.

### 9.3 Other Water Supplies Yield and Cost

The range of water supplies, the unit cost, risks, and other benefits besides reductions in water demands for water transfer and seawater desalination are presented in Exhibit 9B. LADWP recognizes the value of these water supplies in offsetting unanticipated changes to supply or demand. Strategic water planning necessarily includes continuous monitoring of existing and future alternative water resources.

#### Exhibit 9B Other Water Supplies

Other Water Supplies				
Water Supply Alternatives	Potential Water Yield (AFY)	Average Unit Cost (\$/AF)	Implementation Risks	Additional Benefits
Seawater Desalination <sup>1</sup>	25,000	\$1,300-\$2,000	Environmental permitting may be difficult.	Replaces water committed to the environment. Hedges against climate change.
Water Transfer	40,000	\$440-\$540 <sup>2</sup>	Wheeling and other institutional issues must be addressed.	Replaces water committed to the environment.

For Comparison Purposes:
Local Groundwater Pumping Unit Cost = \$230/AF
MWD Treated Tier 2 Water Supply Unit Cost = \$811/AF

**Notes:**

1. Source: Metropolitan Water District of Southern California Integrated Water Resources Plan 2010 Update – Report No. 1373. While the ocean is a virtually unlimited supply, yield shown here is the maximum given available land, outfall capacity, and other constraints.
2. Cost includes cost of water and wheeling fees. Treatment costs not included.

# Chapter Ten Integrated Resources Planning

## 10.0 Overview

---

Integrated resources planning is a process used by many water and wastewater providers to meet their future needs in the most effective way possible, and with the greatest public support. The integrated planning process incorporates:

- Public stakeholders in an open, participatory process.
- Multiple objectives such as reliability, cost, water quality, environmental stewardship, and quality of life.
- Risk and uncertainty.
- Partnerships with other agencies, institutions, and non-governmental organizations.

LADWP has been actively involved in integrated resources planning since 1993, when the Metropolitan Water District of Southern California (MWD) initiated the region's first Integrated Resources Plan (IRP). LADWP was an active member of the technical workgroup that oversaw the development of alternatives and recommendations from MWD's IRP. In 1999, the City embarked on its first IRP for wastewater, stormwater and water supply. LADWP was a partner in this effort, working with the City's Bureau of Sanitation (BOS). In 2006, the Greater Los Angeles County IRWMP was approved. LADWP is a member of the IRWMP

Leadership Committee and serves as the chair of the of the Upper Los Angeles River Watersheds sub-region for the IRWMP region.

## 10.1 City of Los Angeles Integrated Water Resources Plan

---

### 10.1.1 Description and Purpose

---

The City's Integrated Water Resources Plan (IRP) is a unique approach of technical integration and community involvement to guide policy decisions and water resources facilities planning. As part of the IRP development, an Environmental Impact Report (EIR) was prepared identifying the recommended alternatives for implementing the City's wastewater, runoff, and recycled water programs to meet its 2020 needs. On November 14, 2006, the City Council unanimously adopted the IRP recommendations and implementation strategy and certified the final EIR. The IRP development was a seven year stakeholder-driven process and was an innovative approach to guide the City's

policy decisions and facilities planning. The IRP recognizes the interrelationship of water, wastewater, and runoff management in forming a future vision for the City's water resources activities and functions. In the past, the City traditionally utilized single-purpose planning efforts for each agency, such as one plan for wastewater and a separate plan for water supply. With the IRP, the City can meet its 2020 needs in a more cost-effective and sustainable way by addressing and integrating all its water resources. Additionally, the IRP was designed to meet multiple objectives, including evaluation of innovative supply opportunities that were once thought of as being too expensive. The City's LADWP and BOS are partners in this effort, joined by public stakeholders and other agencies.

The objectives for the IRP were developed by the City and public stakeholders, and represent the major reasons why the plan was developed. These objectives are:

- Protect public health and safety
- Effectively manage system capacity
- Protect the environment
- Enhance cost efficiency
- Protect quality of life
- Promote education

The IRP was developed in three phases. The first phase set policy guidelines for managing the City's water resources for the next 20 years. The second phase had three main deliverables: (1) detailed facility plans for wastewater, stormwater, and recycled water; (2) comprehensive financial plans for wastewater and stormwater; and (3) a certified Environmental Impact Report (EIR). The third phase of the IRP, which is now underway, represents implementation of the facility plans and more detailed studies to support implementation.

### 10.1.2 Integrated Watershed Approach

---

By taking an integrated watershed approach, the IRP identified opportunities that would normally not have been identified if water, wastewater, and stormwater were planned separately. The IRP recognized that all of the City's water resources are linked from a technical, social, and institutional aspect.

The City's IRP has also assisted in identifying partnerships between City agencies for project implementation potentially leading to increases in outside funding from grants and low-interest loans.

An example is the potential three-way partnership between the City's Department of Recreation and Parks, BOS, and LADWP. Land reclamation of blighted industrial and warehouse uses allows the City to create more parks and recreational areas while simultaneously allowing for underground storage of wet weather runoff for subsequent beneficial reuse. With this integrated approach, the City can potentially obtain more parkland, assist BOS in reducing wet weather runoff to improve water quality, and assist LADWP in increasing water supplies. The integrated approach also allows the City to better position itself for grants and loans that typically prioritize projects that demonstrate multiple benefits (e.g., water quality, water supply and recreation).

### 10.1.3 Stakeholder Involvement

---

A key element of the IRP was involvement of stakeholders throughout the entire IRP process. Stakeholders represented a wide range of the City's interests including, but not limited to, community, business, and environmental organizations. Stakeholders were

instrumental in development of the guiding principles and identification of innovative water resource opportunities.

During Phase 2, stakeholders participated in a Steering Group. Steering Group members regularly attended scheduled workshops and provided on going input on the technical, environmental, and financial development of the IRP. Members provided necessary feedback to keep the facilities planning efforts aligned with the decision-making process. The Steering Group also considered key project issues in regards to the development of alternatives, such as facilities siting, implementation risks, and acceptability of costs associated with projects.

### 10.1.4 IRP Alternatives

---

The IRP evaluated a broad range of integrated alternatives. Each alternative represented different combinations of wastewater treatment options, wastewater collection system options, recycled water options, conservation options, and dry and wet weather urban runoff management options.

Twenty-one (21) preliminary alternatives were created with different focuses, allowing stakeholders and decision-makers to see trade-offs in key planning objectives. Based on the evaluation of the preliminary alternatives, nine (9) hybrid alternatives were created that incorporated the best elements from the preliminary alternatives in order to improve overall performance. City staff recommended the top-scoring four (4) hybrid alternatives to be carried through to the EIR process. Public stakeholders concurred with staff recommendations.

In November 2006, City Council approved the staff-recommended alternative, which consists of “Go-Projects”, “Go-If-Triggered Projects” and “Go-Policy Directions”. “Go-Projects” are projects recommended for immediate

implementation because the flow and regulatory triggers have already been met. “Go-If-Triggered Projects” will only be implemented if or when additional information or circumstances, such as regulatory requirements, population growth, or increases in sewage flow, materialize. “Go-Policy Directions” are specific directions to City staff on further studies and evaluations necessary to progress on programmatic elements.

### 10.1.5 IRP Implementation Status

---

LADWP, in partnership with the City’s Department of Public Works, has been working collaboratively along with other City departments on coordinating and implementing the various IRP recommendations. As part of the IRP implementation phase, the City has worked on keeping IRP stakeholders engaged through annual stakeholder meetings. Through these meetings, the City has provided updates on the IRP implementation and has obtained valuable input from stakeholders on IRP related issues. In addition, the Board of Water and Power Commissioners and the Board of Public Works have held three public joint meetings to review the IRP progress and provide directions on policy issues. Since the adoption of the IRP by the City Council in November 2006, a number of initiatives have been undertaken by the City which fulfill the IRP goals, including the Green Streets and Green Alleys Committee, the development of a Low Impact Development Ordinance, Conservation Initiatives (Chapter 3), the Recycled Water Master Plan (Chapter 4), and Watershed Management (Chapter 7). Projects and policies in the IRP implementation strategy are detailed below. Some projects are currently being implemented, while others continue to be monitored for triggers or policy direction:



## Go Projects

- Construct wastewater storage facilities at Donald C. Tillman Water Reclamation Plant (DCT).
- Construct wastewater storage facilities at Los Angeles-Glendale Water Reclamation Plant (LAG).
- Construct recycled water storage facilities at LAG.
- Construct solids handling and truck loading facility at Hyperion Treatment Plant (HTP).
- Construct two new sewer lines, Glendale Burbank Interceptor Sewer and Northeast Interceptor Sewer Phase II.

## Go-If-Triggered Projects

- Potential upgrades at DCT to advanced treatment at current capacity (if triggered by regulations and/or decision to reuse DCT effluent for groundwater replenishment).
- Potential expansion and upgrade of DCT to 100 mgd (if triggered by an increase in population, regulations, and/or groundwater replenishment decision). In the unlikely event that the overall framework for recycled water changes to disallow its use, then HTP would be potentially expanded to 500 mgd instead.
- Potential upgrades at LAG to advanced treatment at current capacity (if triggered by regulations and/or availability of downstream sewer capacity).
- Design and construction of additional secondary clarifiers at HTP to provide 450 mgd operational performance.
- Design and construction of up to 12 solids digesters at HTP (if triggered by increased biosolids production in the service area).

- Design and construction of Valley Spring Interceptor Sewer.

Of the “Go-Policy Directions” which provide specific directions to City staff on further studies and evaluations necessary to progress on programmatic elements., those applicable to or with the potential to impact LADWP operations include:

## Recycled Water – Non-Potable Uses

- Direct LADWP and the Department of Public Works to work together to maximize recycled water use and identify recycled water for non-potable uses in the TIWRP service area, west side, and LAG service areas. LADWP is to conduct additional Tier 1 and 2 customer analyses to verify potential demands and feasibility and develop a long-range marketing strategy for recycled water that includes a plan for recruiting and retaining new customers.
- Direct the Department of Building and Safety to evaluate and develop ordinances to require installation, where feasible, of dual plumbing for new multi-family, commercial and industrial development, schools, and government properties in the vicinity of existing or planned recycled water distribution systems in coordination with the Los Angeles River (LA River) Revitalization Master Plan. Proximity and demand will be considered when determining feasibility. The dual plumbing will consist of separate plumbing and piping systems, one for potable water and the second for recycled water for non-potable uses, such as irrigation and industrial use.
- Direct the Department of Public Works and LADWP to continue to coordinate, where feasible, the design/construction of recycled water distribution piping (purple pipe) with other major public works projects, including street widening, and LA River Revitalization Master Plan project areas. Also coordinate with other agencies, including the Metropolitan Transit Authority and Caltrans, on major transportation projects.

### **Recycled Water – Indirect Potable Uses (Groundwater Replenishment)**

- Direct LADWP to develop a public outreach program to explore the feasibility of implementing groundwater replenishment with advanced treated recycled water.

### **Recycled Water – Environmental Uses**

- Direct LADWP and the Department of Public Works to continue to provide water from DCT to Lake Balboa, Wildlife Lake, and the Japanese Garden at Sepulveda Basin, and the LA River to meet baseline needs for habitat.

### **Water Conservation**

- Direct LADWP to continue conservation efforts, including programs to reduce outdoor water usage through the use of smart irrigation devices on City properties, schools, and large developments (those with 50 dwelling units or 50,000 gross square feet or larger), and to increase incentives to residential properties.
- Direct LADWP to work with the Department of Building and Safety in continued conservation efforts by evaluating and considering new water conservation technologies, including no-flush urinal technology.
- Direct LADWP to continue to work with the Department of Building and Safety on conservation efforts by evaluating and developing a policy that requires developers to implement individual water meters for all new apartment buildings.
- Direct LADWP to continue conservation awareness efforts, including increasing education programs on the benefits of using climate-appropriate plants with an emphasis on California friendly plants for landscaping or landscaped areas developed in coordination with the LA River Revitalization Master

Plan, and to develop a program of incentives for implementation.

- Direct the City Planning Department to consider development of a City directive to require use of California friendly plants in all City projects where feasible and not in conflict with other facilities usage.

### **Runoff Management – Wet Weather Runoff**

- Direct the Department of Public Works to review SUSMP (Standard Urban Stormwater Management Plan) requirements to determine ways to require, where feasible, on-site filtration and/or treatment/reuse, rather than treatment and discharge, including in-lieu fees for projects where infiltration is infeasible.
- Direct the Department of Building and Safety to evaluate and modify applicable codes to encourage the installation of all feasible Best Management Practices (BMPs), including the use of porous pavement to maximize on-site capture and retention and/or infiltration of stormwater instead of discharge to the street and storm drain.
- Direct the Department of Public Works and the City Planning Department to evaluate the possibility of requiring porous pavement in all new public facilities in coordination with the LA River Revitalization Master Plan, and developments larger than one acre. Program feasibility should consider slope and soil conditions.
- Direct the City Planning Department to evaluate ordinances that would need to be changed to reduce the area of on private properties that can be paved with non-permeable pavement.
- Direct the Department of Public Works to evaluate and implement integration of porous pavements into sidewalks and street programs where feasible.



- Direct the Department of Public Works, LADWP, and the Department of Recreation and Parks to prepare a concept report and determine the feasibility of developing a powerline easement demonstration project for greening, public access, stormwater management, and groundwater replenishment.
- Direct the Department of Public Works and LADWP to work with the Los Angeles Unified School District to determine the feasibility of developing projects for both new and retrofitted schools, as well as for government/ City-owned facilities, to implement stormwater management BMPs (cisterns to store runoff for irrigation, reduce paving and hardscapes, add infiltration basins).
- Direct the Department of Public Works, the General Services Department, and the Department of Recreation and Parks, to identify sites that can provide on-site percolation of wet-weather runoff in surplus properties, vacant lots, parks/ open spaces, abandoned alleys in the East Valley area, and along the LA River in the East San Fernando Valley where feasible. Program feasibility should consider slope and soil conditions.
- Direct the Department of Public Works, the General Services Department, and the Department of Transportation to maximize unpaved open space in City-owned properties and parking medians by using all feasible BMPs and by removing all unnecessary pavement.
- In the context of developing Total Maximum Daily Load (TMDL) implementation plans, direct the Department of Public Works to consider diversion of dry weather runoff from Ballona Creek to constructed wetlands, wastewater system, or urban runoff plants for treatment and/or beneficial use. For inland creeks and storm drains tributary to the LA River, direct the Department of Public Works to consider diversion of dry weather runoff to the wastewater system or constructed

wetlands or treatment/retention/ infiltration basins.

- Direct the General Services Department, in coordination with the City Planning Department and the Department of Public Works, to evaluate feasibility of all City properties identified as surplus for potential development of multi-benefit projects to improve stormwater management, water quality, and groundwater recharge.

## Los Angeles River

The IRP planning effort included the Los Angeles River (LA River). The LA River is a valuable resource to the City providing habitat as well as recreational and economic opportunities. Since the City's water reclamation plants were built, recycled water has been released to the LA River resulting in the development of significant environmental benefits from riparian habitat in the unlined portions of the LA River near Glendale, to regionally significant migratory shore bird habitat in Long Beach. As a result, many efforts have been developed to protect existing habitat and promote interest in habitat restoration and river revitalization.

The IRP established that treated wastewater is needed for the operation of Lake Balboa, the Japanese Gardens, and the Wildlife Lake in the Sepulveda Basin. Treated wastewater flows through these features and ultimately is released to the LA River from DCT. The remainder of the treated wastewater produced by the City's water reclamation plants is available for recycled water use and distribution to LADWP customers.

Shortly after work on the IRP began, the Los Angeles City Council's Ad Hoc Committee on the LA River (Ad Hoc Committee) was formed to address LA River revitalization. LADWP staff routinely attends Ad Hoc Committee meetings and functions and monitors LA River-related activities.

LADWP also funded the preparation of a Los Angeles River Revitalization Master

Plan which was approved in 2007. This plan addresses economic development opportunities, water quality, water resources, flood control, and recreation along the Los Angeles River. The plan also discusses opportunities to improve access to the Los Angeles River and increase community awareness.

In addition, LADWP staff also actively participates on the City's LA River Task Force, which was formed in response to instructions by the Ad Hoc Committee to:

- Inventory all current and future City department projects, studies, and programs along the LA River.
- Assess opportunities for future funding, projects, and studies.
- Coordinate LA River related activities of City departments and other agencies.
- Partner with the U.S. Army Corps of Engineers for a Habitat Restoration Project Study.

LADWP recognizes the importance of the Los Angeles River as a resource that provides multiple benefits to the City.

### **10.1.6 Agency Coordination**

---

LADWP was a partner with BOS in developing the IRP along with public stakeholders and other agencies. As with any integrated plan that extends beyond traditional departmental boundaries and government jurisdictions, close coordination is required with multiple City, state, and federal agencies including but not limited to, the Cities of Burbank and Glendale, County of Los Angeles, Caltrans, U.S. Army Corps of Engineers, U.S. Bureau of Reclamation, and the City Department of Recreation and Parks. Since approval of the IRP, ongoing project implementation and "Go-Policy Directions" continue to require close coordination with City departments and with the agencies listed above.

### **10.1.7 IRP Implications for City's Urban Water Management Plan**

---

One of the primary purposes for developing the IRP was to explicitly consider the relationship between wastewater facility planning and other water resources issues, such as water supply and urban runoff. Implementation of the IRP has and will continue to result in increased beneficial reuse of water, water conservation, and groundwater supplies. IRP alternatives examined ways to decrease potable water needs by expanding the City's recycled water program; increase water efficiency by installing smart irrigation and other water efficient devices that reduce irrigation and indoor water demands; and increase groundwater resources by using wet weather runoff to recharge the aquifer. All of these options will have to be tested from a technical, institutional, and public acceptance perspective. Ongoing work on programmatic elements identified in the "Go-Policy Directions" applicable to LADWP will continue to investigate means of increasing local water supplies, water conservation, and groundwater recharge opportunities in an integrated manner. The IRP has demonstrated that by integrating water resources planning for the City, more opportunities for water supply development can be identified.

## **10.2 Greater Los Angeles County Integrated Regional Water Management Plan (IRWMP)**

---

### **10.2.1 Description and Purpose**

---

The Los Angeles County Department of Public Works led efforts to develop an

Integrated Regional Water Management Plan for the Greater Los Angeles County Region. Water quality, resource, and supply issues within the region are complex and managed by a myriad of government agencies subjected to a plethora of regulations. Exponential growth over the last century has required water managers to develop creative solutions to meet growing demands. Previously, projects addressing water issues were designed to appease single-focused visions and solutions of organizations operating independently. At the core of the plan, a clear vision and direction for the sustainable management of water resources within the region for the next twenty years was formulated. Over 1,600 projects were collected and synthesized for inclusion in the plan bringing together hundreds of local government agencies to cooperatively develop cost-effective, sensible, and economically feasible solutions to address regional water issues. New partnerships were forged between potential funding partners from within and outside the region. An innovative partnership between agencies was formed to create a new model of integrated regional planning to address competing water demands, water supply reliability, and project financing.

An Interim Draft of the IRWMP was adopted by the Leadership Committee on June 28, 2006 with a final plan adopted on December 16, 2006. To date the IRWMP has received \$25 million from the Department of Water Resources (DWR) under Proposition 50, Chapter 8, for implementation of fourteen priority projects identified in the plan and \$1.5 million from DWR for development of the IRWMP. Since completion of the document a revised Memorandum of Understanding (MOU) was executed by each of the sixteen agencies serving on the Leadership Committee for the purpose of developing, administering, updating, and implementing the IRWMP.

## Region

The IRWMP region encompasses 92 cities, portions of four counties, and hundreds of

government agencies and districts spread over 2,058 square miles. Approximately 10.2 million residents, or equivalent to roughly 28 percent of the population of California, reside within the region. To facilitate input, variations in geographic and water management strategies, and effective planning the region was further subdivided into five sub-regions:

- Lower San Gabriel and Los Angeles River Watersheds
- North Santa Monica Bay Watersheds
- South Bay Watersheds
- Upper Los Angeles River Watersheds
- Upper San Gabriel River and Rio Hondo Watersheds

## Mission and Purpose

A collaborative process resulted in the following mission statement of the IRWMP: "To address the water resources needs of the Region in an integrated and collaborative manner." The IRWMP recognizes that in order to meet future needs water supply planning must be integrated with other resource strategies. Additionally, in a region with significant urban challenges, including population growth, densification, traffic congestion, poor air quality, and quality of life issues, it is imperative to consider water resources management in conjunction with other urban planning issues. The IRWMP's purpose is to proactively:

- Improve water supplies
- Enhance water supply reliability
- Improve surface water quality
- Preserve flood protection
- Conserve habitat
- Expand recreational access

## 10.2.2 Stakeholder Involvement

---

Over 1,400 invitations to participate in the IRWMP process were sent out to cities, counties, agencies, districts, disadvantaged communities, and community organizations. Stakeholders participated in workshops, project identification, and development of the IRWMP. Stakeholders were involved in the development of the IRWMP through participation in regional workshops, subregional workshops, and the Leadership Committee. Stakeholders assisted in the following:

- Development of the IRWMP mission and objectives.
- Refinement of procedures for incorporation of projects into the IRWMP.
- Identification of implementation strategies.
- Recommendation of stakeholder workshop improvements.

## 10.2.3 Recommended Projects

---

Over 1,600 projects were submitted and analyzed for inclusion in the IRWMP. This list was narrowed down to fourteen priority projects that met the objectives and priorities established by the IRWMP process and assisted in meeting the targets established for the planning region. Objectives and priorities were established to guide the project selection process. The IRWMP is a living document and will be updated as needed. Projects can continuously be submitted as they are identified by stakeholders.

## Objectives and Priorities

Six objectives and six long-term priorities were developed through the stakeholder process to guide project selection based on stakeholder input and previously completed documents, including UWMPs, MWD's IRP, Common Ground (San Gabriel & Los Angeles Rivers and Mountains Conservancy Plan), Santa Monica Bay Restoration Plan, and watershed plans for the major tributaries in the region.

The objectives of the IRWMP are to:

- Optimize local water resources to reduce the Region's reliance on imported water.
- Comply with water quality regulations (including TMDLs) by improving the quality of urban runoff, runoff, stormwater, and wastewater.
- Protect and improve groundwater and drinking water quality.
- Protect, restore, and enhance natural processes and habitats.
- Increase watershed friendly recreational space for all communities.
- Maintain and enhance public infrastructure related to flood protection, water resources, and water quality.
- Long term regional priorities are to:
  - Maintain a regional and sub-regional structure to oversee plan implementation and ensure continued stakeholder input.
  - Optimize use of recycled water, groundwater, desalination, and stormwater to enhance water supply reliability.
  - Reduce demand on imported water sources.
  - Protect groundwater supplies.

- Improve surface water quality to meet applicable water quality regulations, including TMDLs.
- Preserve open space, conserve and restore functional habitats, and protect special-status species.

## Targets

Targets for the region were developed to assist in prioritizing projects. Targets include:

- Increase water supply reliability by providing 800,000 AFY of additional water supply and demand reduction through conservation, including infiltration or reuse of 130,000 AFY of reclaimed water.
- Reduce and reuse 150,000 AFY (40%) of dry weather urban runoff and capture and treat an additional 170,000 AFY (50%) for a total target of 90 percent.
- Reduce and reuse 220,000 AFY (40%) of stormwater runoff from developed areas and capture and treat an additional 270,000 AFY (50%) for a total of 90 percent.
- Treat 91,000 AFY of contaminated groundwater.
- Restore 100+ linear miles of functional riparian habitat and associated buffer habitat.
- Restore 1,400 acres of functional wetland habitat.
- Develop 30,000 acres of recreational open space focused in under-served communities.
- Repair/replace 40 percent of aging water resources infrastructure.

## Projects

Fourteen priority projects were developed for the Greater Los Angeles County region. As a regional plan encompassing an area larger than LADWP's service area, many

of the IRWMP projects do not directly benefit LADWP's service area, but rather provide benefits towards improving water resources in the region as a whole. However, LADWP can utilize the results of these projects and apply the knowledge to potentially develop similar programs within the service area. Brief descriptions of the priority projects are provided below.

### ***Southeast Water Reliability Project***

The Southeast Water Reliability Project consists of an 11.4 mile recycled water transmission pipeline from the City of Pico Rivera to the City of Vernon to complete Central Basin Municipal Water District's recycled water transmission system. Recycled water will be mainly provided by the County Sanitation Districts of Los Angeles County via the San Jose Creek Water Reclamation Plant.

### ***Joint Water Pollution Control Plant Marshland Enhancement***

The Joint Water Pollution Control Plant Marshland Enhancement Project is designed to improve and maintain plant and wildlife habitat at the seventeen acre freshwater marshland located at the Joint Water Pollution Control Plant (JWPCP) in Carson. As proposed, the project will serve as a mitigation measure for upgrading the JWPCP to full secondary wastewater treatment. The JWPCP is operated by the County Sanitation Districts of Los Angeles County.

### ***Large Landscape Water Conservation, Runoff Reduction, and Educational Program (Central Basin)***

The Large Landscape Water Conservation, Runoff Reduction, and Education Program is an end-use water management program to reduce runoff and address water/energy management associated with large landscapes, residential land uses, and street medians within the Central Basin Municipal Water District's service area. Weather-based irrigation controllers coupled with Geographic Information Systems (GIS) to monitor runoff and two-way communication technologies

will provide necessary information to address emergency, drought, and end-use management challenges.

### ***Large Landscape Water Conservation, Runoff Reduction, and Educational Program (West Basin)***

West Basin Municipal Water District's (WBMWD) Large Landscape Water Conservation, Runoff Reduction, and Educational Program is a four-component project. The first component targets large landscape sites of 1 acre or more by providing centralized weather-based irrigation controllers with the goal of conserving 1 AFY per acre of land. The second component provides 1,350 rebates for the purchase of smart irrigation controllers for the top residential water users. A third component consists of developing and offering classes on residential landscaping for residences and businesses. The last component involves installing ten "Ocean Friendly" demonstration gardens throughout watersheds in the service area.

### ***Las Virgenes Creek Restoration Project***

The City of Calabasas is initiating the Las Virgenes Creek Restoration Project to restore 450 linear feet of a concrete-lined section of the creek to a natural function. Native vegetation will be planted in place of the concrete liner to establish connectivity between riparian habitat north and south of the existing liner.



### ***Malibu Creek Watershed Urban Water Conservation and Runoff Reduction Project***

As proposed, the Malibu Creek Watershed Urban Water Conservation and Runoff Reduction Project seeks to conserve water and reduce runoff in the City of Westlake Village and within the Las Virgenes Municipal Water District's (LVMWD) service area. Irrigation controllers on city-owned land in Westlake Village will be replaced with weather-based irrigation controllers. Within the LVMWD service area, indoor conservation will be addressed by continuing rebates for residential and multi-family customers to install water saving devices. This project will also continue existing efforts to reduce urban runoff and outdoor conservation in the LVMWD service area by targeting customers with persistent and substantial irrigation runoff in the vicinity of storm drains. These customers are offered water-efficient equipment rebates and free on-site assistance to upgrade irrigation systems to eliminate runoff.

### ***Morris Dam Water Supply Enhancement Project***

The Morris Dam Water Supply Enhancement Project would allow the capture of additional local runoff (5,720 AF) for groundwater recharge and extraction in the San Gabriel River watershed. This project would reduce the minimum pool required by the Los Angeles County Flood Control District (LACFCD) to prevent sediment damage to the outlet works of the dam by modifying the dam valves and control systems.

### ***Pacoima Wash Greenway Project***

The Pacoima Wash Greenway will treat storm runoff from neighborhoods adjacent to the wash in a series of parks incorporating stormwater treatment BMPs along the wash. Project development will be a joint effort between the City of San Fernando and the Mountains Recreation and Conservation Authority.

### ***San Gabriel Valley Riparian Habitat Arundo Removal Project***

Arundo donax, a non-native plant classified federally and by California as noxious weed, will be removed from approximately 30 acres of riparian habitat in the San Gabriel Watershed. Removal will increase surface water flows to the Rio Hondo percolation basins and improve native habitat.

### ***Solstice Creek Restoration Project***

The Solstice Creek Restoration Project will restore side drainages of Solstice Creek and areas negatively impacting riparian habitat through sediment and invasive species introduction. This project is part of an overall larger project to restore Solstice Creek.

### ***South Los Angeles Wetlands Park***

The South Los Angeles Wetlands Park project will involve purchasing a 9 acre parcel in Los Angeles on Avalon Boulevard for conversion to a wetlands park. As proposed, the wetlands park will treat urban runoff from a 520 acre area through installation of a series of BMPs. Park vegetation will consist of plants not requiring supplemental irrigation.

### ***Whittier Narrows Water Reclamation Plant Ultraviolet (UV) Disinfection***

The Whittier Narrows Water Reclamation Plant UV Disinfection project will convert current disinfection processes at the 15 mgd plant to a UV disinfection process. Currently, tertiary-treated water is disinfected to Title 22 recycled water standards using chloramination resulting in the production of NDMA byproducts.

### ***Wilmington Drain Restoration Multiuse***

As proposed, the Wilmington Drain Restoration Multiuse Project involves restoration of the Wilmington Drain. Restoration will involve creation of a public park, improved public access, native revegetation, stormwater treatment, and educational signage. The

drain is within the City on an easement held by the LACFCD.

### ***North Atwater Creek Restoration***

As a component of the overall Los Angeles River Revitalization Plan, the North Atwater Creek Restoration Project will restore North Atwater Creek at North Atwater Park by providing stormwater runoff capture and treatment and the provision of habitat linkage to the Los Angeles River. Additionally, the project will provide an educational component and includes BMP implementation at adjacent horse stables and riding trails.



## **10.2.4 Implications of IRWMP for LADWP's Urban Water Management Plan**

LADWP is a member of the IRWMP Leadership Committee and additionally serves as the chair of the of the Upper Los Angeles River Watersheds sub-region for the IRWMP region. As member of the Leadership Committee, LADWP is a signatory to the MOU for the IRWMP approved by the Board of Water and Power Commissioners on July 15, 2008.

Participating agencies in the IRWMP coordinate and share information concerning water resources management planning programs and projects, share grant funding information, and improve and maintain overall communication among the participants. Coordination and information sharing assists LADWP and other agencies in achieving their respective missions and contribute to overall IRWMP goals.

## 10.3 MWD's 2010 Integrated Resources Plan

Approved by the Board on October 12, 2010, the updated IRP is MWD's strategic plan for water reliability through the year 2035. The plan was developed through a collaborative process which incorporated input from water districts, local governments, stakeholder groups and the public. The earliest version of the IRP, which dates back to 1996, sets a regional reliability goal of meeting "full-service demands at the retail level under all foreseeable hydrologic conditions." The 2010 IRP maintains this reliability goal by seeking to stabilize MWD's traditional imported water supplies and establish water reserves to withstand California's inevitable dry cycles and growth in water demand.

The 2010 IRP update has three main objectives: (1) develop an Emergency Response Plan for hydrologic, regulatory,

and other types of uncertainties in the Bay-Delta; (2) identify energy-efficient and cost-effective energy management initiatives; and (3) evaluate the reliability of the IRP Preferred Resource Mix through 2035, adjust targets as needed to reflect changed conditions, and extend resource targets through 2035.

The 2010 IRP manages regional resource needs utilizing three baseline components. It begins with baseline efforts – or core resource strategies – designed to maintain reliable water supplies. Its second component – the uncertainty buffer – activates buffer actions to mitigate short-term changes. If changed conditions become more pronounced, there is a final component – foundational actions – which are strategies for securing additional water resources.

Additionally, the 2010 IRP takes additional steps to promote water use efficiency to further ensure reliability. It spells out a strategy to buffer the region from

### Exhibit 10A MWD's IRP Resource Targets

IRP Resource Targets	2004 IRP Update 2025	2010 IRP Update 2025	Change	2010 IRP Update 2035
Conservation	1,107,000	1,412,000	305,000	1,538,000
Local Projects*	750,000	905,000	155,000	928,000
Colorado River Aqueduct **	1,250,000	1,250,000	0	1,250,000
State Water Project	650,000	713,000	63,000	713,000
Groundwater Conjunctive Use	300,000	300,000	0	300,000
Central Valley/ State Water Project Storage and Transfers	550,000	1,070,000	520,000	1,092,000
MWD Surface Water Storage***	620,000	620,000	0	620,000

\* Includes recycled water, brackish groundwater desalination, and seawater desalination

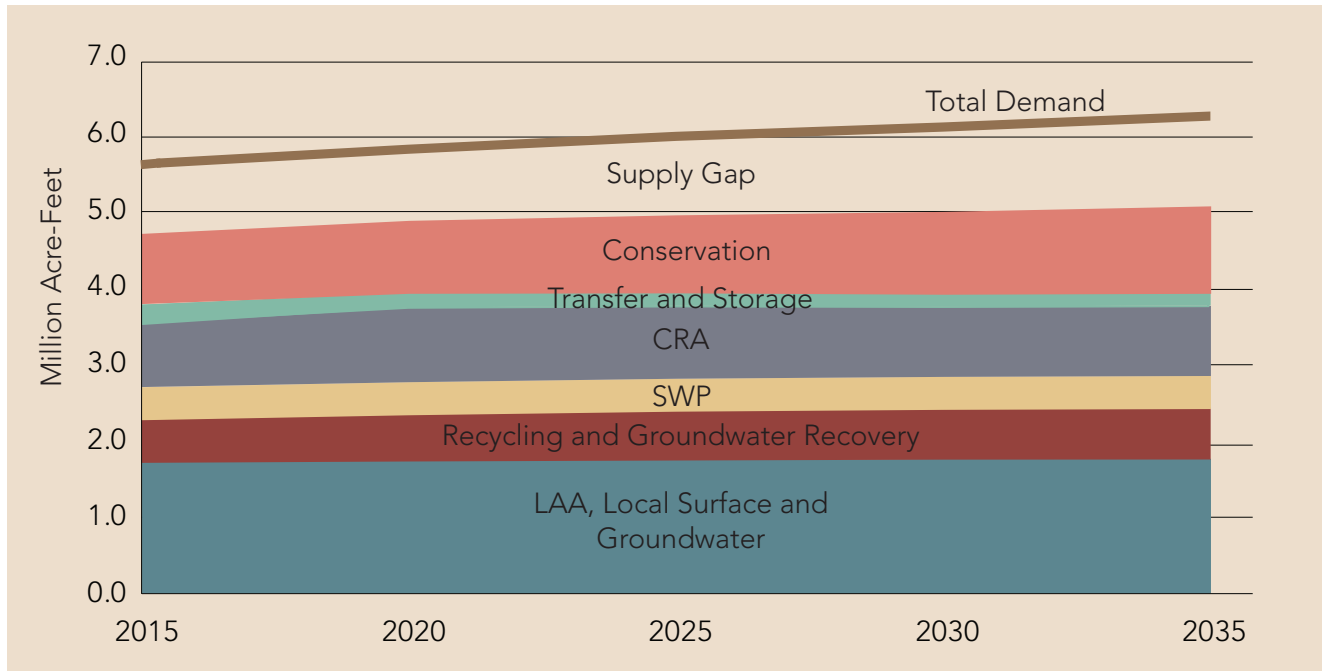
\*\* Target for specific year types, the CRA is not intended to be full at all times

\*\*\* Represents the total amount that can be withdrawn from surface reservoirs

Source: MWD (2010)



**Exhibit 10B**  
**Meeting Regional Water Needs Through MWD's IRP**



future changing circumstances through accelerated conservation and local supply development. And it advances long-term planning for potential future contingency resources, such as stormwater capture, large-scale seawater desalination, and local resource development through an adaptive management approach which will allow MWD, for the first time, to make direct equity investments and/or enter into partnerships for the development of local supply projects.

A summary of the 2004 IRP update and 2010 update targets are shown in Exhibit 10A.

Exhibit 10B shows regional water demands without conservation from 2015 to 2035 under dry weather. The graph also depicts the supply sources and water conservation identified in MWD's 2010 IRP update.

Exhibit 10B shows regional water demands without conservation from 2015 to 2035 under dry weather. The graph also depicts the supply sources and water conservation identified in MWD's 2010 IRP Update.

**10.3.1 Stakeholder Participation**

Like the preparation of previous IRPs, the crafting of the 2010 IRP was a collaborative effort. MWD sought input from its 26 public member agencies, retail water agencies, the public and other stakeholders including water and wastewater managers, environmental interests, and the business community. In preparation of MWD's IRP, all member agencies were closely involved, including LADWP. Additionally, LADWP was an active member of the technical workgroup.

To provide more direct involvement by MWD's Board in the 2010 IRP preparation, the IRP Steering Committee was created. This committee met on a regular basis to be briefed by MWD staff, review proposed resource strategies and provide recommended policy options. A Strategic Policy Review was conducted through a series of board workshops and managed public forums to help Metropolitan evaluate its future role for the region.



The managed public forums were regional assemblies held at critical milestones during the IRP development that provided a platform to collectively discuss strategic direction and regional water solutions. Participants in these assemblies included elected officials, board members, water agency managers, local retail water providers, groundwater basin managers, and public stakeholders from the business community, environmental groups, agricultural interests, and the general public.

- **Water Use Efficiency** – costs for water supply will increase from the current \$892/AF in 2015 to \$1,608/AF in 2035.
- **Capital Expenditures** – costs for water supply will increase from \$919/AF in 2015 to \$1,844/AF in 2035.
- **Demand Management & Local Projects** – costs from water supply will increase from \$953/AF to \$2,021/AF in 2035.

### 10.3.2 Funding MWD's IRP

In accordance with the MWD Board's adoption of the IRP update, a revised Long-Range Finance Plan (LRP) was also developed and approved by the MWD Board. The LRP (2010) identifies MWD's planned capital improvement program (CIP) and operating expenses from 2015 to 2035.

The following summarizes MWD's CIP and operating expenses needed to implement the IRP:

- **Core Resources** (Fixed costs to maintain Bay-Delta habitat conservation and conveyance program, LRP contracts, CRA programs, and conservations funding) – costs for water supply will increase from the current \$853/AF in 2015 to \$1,484/AF in 2035.

### 10.3.3 IRP Implications for City's Urban Water Management Plan

As LADWP evaluates its water supply options, it is important to understand the significance of a reliable and cost-effective water supply from MWD. The City's water supply reliability is directly linked to MWD's reliability, and LADWP's local supply development uses the cost of MWD water as one of the benchmarks for feasibility evaluation. Through its 2010 IRP update, MWD has shown that it will be able to meet the supplemental needs of all its member agencies reliably through 2035, even during prolonged drought events. MWD has also developed a plan to implement and finance the approved IRP targets.

## Chapter Eleven

# Water Supply Reliability and Financial Integrity

## 11.0 Overview

---

Providing a reliable water supply in a semiarid climate with high variability in weather is challenging. And because LADWP currently imports a substantial portion of its surface water from the Los Angeles Aqueduct (LAA) and Metropolitan Water District of Southern California (MWD), it is even more challenging. Imported surface supplies are highly variable due to climate and hydrology, and they are also subject to environmental restrictions. To diversify its water supply portfolio, LADWP has made and will continue to make significant investments in groundwater, recycled water, stormwater capture and water conservation. These local water supplies tend to be more reliable than imported water because they have less variability due to climate, weather, and environmental restrictions. And by investing in these local supplies, the City's urban environment is protected and enhanced.

## 11.1 Unit Cost and Funding of Supplies

---

### 11.1.1 Unit Cost Summary of Supplies

---

Unit costs play an important role in planning future water supply development and determining where supply investments provide the greatest benefits to LADWP. Unit costs of production vary dramatically by water supply source. Exhibit 11A summarizes the unit cost for each water supply source.

Among LA's existing and planned water supplies, costs per acre-foot ranged from a high of \$1,500 for certain recycled water projects to a low of \$215 for locally produced groundwater. LAA supply requires operation and maintenance costs regardless of water availability. Therefore, hydrology and increased water for environmental commitments in the Eastern Sierras result in LAA unit cost fluctuations from year to year. Local groundwater supply is the least expensive source. However, its production is limited by contamination. Unit costs for MWD purchased water vary based on tier allocations. MWD's water rates vary from \$527 per AF of Tier 1 untreated water to \$869 per AF of Tier 2 treated water in 2011. LADWP has a Tier 1 allocation of 304,970 AF. Any purchases above this amount will be at the Tier 2 rates. Conservation is relatively inexpensive and offsets water supplies that may

otherwise be required to meet demand. Conservation unit costs are based on costs of conservation rebate and incentive programs and their potential water use reduction. Recycled water costs are project specific and vary widely depending on the infrastructure requirements of each project. Water transfers using a future connection between the LAA and the California Aqueduct are planned. Water transfer costs will include the purchase price of water and conveyance fees.

Unit costs for potential water supplies such as stormwater reuse and increased groundwater production from stormwater recharge are highly variable based on a variety of factors including the size of the overall program, project locations, etc. Centralized stormwater capture unit

costs are based on LADWP's current planned centralized stormwater capture projects, and distributed stormwater capture unit costs are based on various sources as referenced in Chapter 7, Watershed Management. Stormwater projects are joint efforts among agencies, City departments, stakeholders and community groups and yield additional benefits beyond water supply.

Seawater desalination unit costs are based on estimates from MWD's 2010 IRP. Seawater desalination was a planned supply identified in the 2005 UWMP but is excluded from this 2010 UWMP. Its impacts to marine habitats and high energy consumption make seawater desalination less desirable compared to options such as recycled water, conservation, and stormwater capture.

### Exhibit 11A Unit Costs of Supplies

Water Source	Chapter Reference	Average Unit Cost (\$/AF)
Los Angeles Aqueduct <sup>1</sup>	Chapter 5 - Los Angeles Aqueduct System	\$563
Groundwater <sup>1</sup>	Chapter 6 - Local Groundwater	\$215
Metropolitan Water District <sup>2</sup>	Chapter 8 - Metropolitan Water District Supplies	\$527 - \$869
Conservation	Chapter 3 - Conservation	\$75 - \$900
Recycled Water	Chapter 4 - Recycled Water	\$600 - \$1,500
Water Transfer	Chapter 9 - Other Potential Supplies	\$440 - \$540
Stormwater Capture	Chapter 7 - Watershed Management	
- Centralized Stormwater Capture		\$60 - \$300
- Distributed Stormwater Capture		
Urban Runoff Plants		\$4,044
Rain Barrels		\$278 - \$2,778
Cisterns		\$2,426
Rain Gardens		\$149 - \$1,781
Neighborhood Recharge		\$3,351
Seawater Desalination	Chapter 9 - Other Potential Supplies	\$1,300 - \$2,000

<sup>1</sup> Los Angeles Aqueduct supply and groundwater supply are based on FY2005/06 to FY2009/10 five-year average.

<sup>2</sup> MWD Water Rates effective on January 1, 2011.

## 11.1.2 Funding of Supplies

---

Funding for water resource programs and projects are primarily provided through LADWP water rates, with supplemental funding provided by the MWD, and state and federal grants. Funding for water conservation, water recycling, and stormwater capture projects has increased significantly in recent years. Currently, approximately \$100 million is collected annually through water rates for the LADWP's water resource programs. The current level of annual expenditures is believed to be sufficient to achieve projected goals for conservation, water recycling, and stormwater capture. However, achieving the goals for contaminated groundwater treatment in the San Fernando Basin will require water rate increases. LADWP will also seek reimbursement from potential responsible parties to assist with groundwater treatment program costs.

The timeframe for achieving water resource goals as outlined in the 2008 document Securing L.A.'s Water Supply was based on the assumption that there would be additional increases in water rates to achieve the stated goals. With the exception of groundwater treatment, the 2010 UWMP assumes existing amounts of revenue.

### Water Resource Project Funding

- **Water Rates** – An existing component of water rates currently provides approximately \$100 million annually for water conservation, water recycling, and stormwater capture programs.
- **MWD** – Currently provides funding up to \$250 per AF for water recycling through their Local Resources Program. MWD also provides some water conservation incentive funding through rebates equal to \$195 per AF of water saved or half the product cost whichever is less.
- **State Funds** – Funds for recycling, conservation, and stormwater capture have been available on a competitive

basis though voter approved initiatives, such as Propositions 50 and 84. The proposed 2012 Water Bond also includes potential funding for groundwater cleanup. Occasionally low or zero-interest loans are also available through State Revolving Fund programs.

- **Federal Funds** – Federal funding for recycling is available through the U.S. Army Corps of Engineers, via periodic Water Resource Development Act legislation, and the U.S. Bureau of Reclamation's Title XVI program.
- **Potentially Responsible Parties** – LADWP may be able to recover some costs for groundwater cleanup from potentially responsible parties.

Receipt of state or federal funding will allow water resource goals to be achieved sooner than projected, or allow for increased local supply development.

## 11.2 Reliability Assessment Under Different Hydrologic Conditions

---

### 11.2.1 Los Angeles Aqueducts

---

Water supply from the LAA can vary substantially from year to year due to hydrology. In very wet years, LAA supply can exceed 500,000 AFY. During average year weather conditions (50-year average hydrology from Fiscal Year 1956/57 to 2005/06) LAA supply is projected to gradually decrease from 254,000 AFY to 244,000 AFY by 2035 due to climate change impact. Critical dry year (defined as a repeat of a 1990/91 drought) supplies can be as low as 48,520 AFY.

In the last decade environmental considerations have required the City

to reallocate approximately one-half of the LAA water supply to environmental mitigation and enhancement projects. Reducing water deliveries to the City from the LAA has resulted in less water independence, and therefore, increased dependence on imported water supply from MWD.

### 11.2.2 Groundwater

---

Groundwater is also affected by local hydrology. However, with conjunctive use management of groundwater—storing imported water in the groundwater basins during wet and average years - groundwater production can actually be increased during dry years. During average weather conditions, LADWP projects it will pump approximately between 40,500 AFY and 111,500 AFY of groundwater during the projection period to Fiscal Year (FY) 2034/35. These projections are based on LADWP's planned Groundwater Treatment Facilities being operational in FY 2020/21 and groundwater storage credits of 5,000 AFY being used to maximize production thereafter. Although in dry years LADWP can pump larger quantities of groundwater, a more conservative approach was adopted by assuming the same level of projected groundwater production for both single dry year and multi-dry year analysis.

Groundwater is vulnerable to contamination. The clean-up of the contamination in San Fernando Basin will facilitate the plan of storing additional recycled water and stormwater for future extraction and is critical to ensuring the reliability of the City's groundwater supplies. The Groundwater Treatment Facilities will address this issue and restore LADWP's ability to fully utilize its local groundwater entitlements and will facilitate additional storage and extraction programs.

### 11.2.3 Conservation

---

LADWP has developed conservation goals to decrease water use in the City and to comply with the new State 20 percent by 2020 requirements. Multiple actions will be taken to increase water conservation including public education, targeting the CII sector, reducing outdoor water use, and continuing participation in MWD's rebate programs. LADWP is planning to increase water conservation levels by over 60,000 AFY between 2010 and 2035, assuming average weather conditions.

Conservation can be seen as both a demand control measure and/or a source of supply. Of the local supplies being pursued, additional planned conservation is the biggest contributor toward reducing MWD purchases and increasing local supply reliability through 2035 and is therefore a crucial supply asset for LADWP.

### 11.2.4 Recycled Water

---

Recycled water is based on wastewater effluent flows, which do not vary significantly due to hydrology. Therefore, recycled water use is mainly limited by system capacities and demands. These facts make recycled water a more reliable supply than imported water. As outlined in Chapter 4 on Recycled Water, LADWP is planning extensive expansion of its recycled water system not only to include expansion of irrigation and industrial uses, but also to include groundwater replenishment. Under average weather conditions, recycled water supply for irrigation and industrial purposes is projected to increase from 20,000 AFY in 2015 to 29,000 AFY in 2035. Groundwater replenishment with recycled water is projected to be 30,000 AFY in 2035. For a critical dry year available recycled water supplies would not change.

## 11.2.5 Water Transfers

---

Water transfers are being developed to replace a portion of the City's Los Angeles Aqueduct water that has been dedicated for environmental enhancement uses in the Eastern Sierra Nevada. Water acquired through transfers helps increase water supply reliability for the City. The Los Angeles Aqueduct and California Aqueduct interconnection is under construction and estimated to be completed after May 2013. LADWP is expected to enter into agreements to obtain 40,000 AF per year under average weather conditions beginning in FY 2014/15 and continuing through 2035.

## 11.2.6 MWD Imported Supplies

---

LADWP has historically purchased MWD water to make up the deficit between in-City demand and local supplies. The City relies on MWD water to a greater extent in dry years and has been increasing its dependence in recent years as LAA supplies have been reduced due to increased environmental mitigation and enhancement demands.

Historically, water from MWD (like supplies from the LAA) has been subject to severe variability due to water shortages (i.e., 1976/77, 1987-1992, and 2007-2010). This is a result of MWD's core sources of water supply being the Colorado River and SWP, both of which are highly affected by hydrology. More recently, restrictions to protect threatened fish species have further decreased pumping from the Bay-Delta, and limited SWP supplies available to MWD. After the 1987-1992 water shortage, MWD started to diversify its water supply portfolio. Partnering with its member agencies, MWD launched its first Integrated Resource Plan (IRP) in 1993 and most recently updated it in 2010. As a result of the resource targets

in the IRP, MWD implemented a variety of projects and programs designed to reduce its dependency on imported water during water shortages and environmental triggering of SWP pumping restrictions. Efforts have included: (1) providing financial incentives for local projects and conservation; (2) increasing surface storage via Diamond Valley Lake, Lake Mead, and the use of SWP terminal reservoirs; (3) groundwater storage programs in the Central Valley, Imperial Valley, and Coachella Valley; (4) short- and long-term water transfers; and (5) contracted groundwater storage programs with participating member agencies.

In the 2010 IRP Update, MWD developed a three-part adaptive resource strategy that includes: (1) meeting demands by building on existing core resources to provide reliability under foreseen conditions; (2) implementing a supply buffer of 10 percent of retail demand through multiple actions to adapt to short-term uncertainty; and (3) implementing adaptive management through low-regret foundation actions, monitoring key vulnerabilities and bringing adaptive resources online, if required, and (4) using a comprehensive approach to meet specific needs and degrees of shortages. The 2010 IRP adaptive management concept seeks to mitigate against supply uncertainty to further increase reliability.

MWD's 2010 IRP Update concluded that the resource targets identified in previous IRP updates, taking into consideration changed conditions identified since that time, will continue to provide for 100 percent reliability through 2035 for all its member agencies. MWD's 2010 Regional Urban Water Management Plan also concluded the same full reliability through 2035 during average (1922 – 2004 hydrology), single dry (1977 hydrology), and multiple dry years (1990 - 1992 hydrology). For each of these scenarios there is a projected surplus of supply in every forecast year (see Exhibit 11B). The projected surpluses are based on the capability of current supplies and range from 1 percent to 106 percent. When

**Exhibit 11B**  
**MWD Supply Capability and Projected Demands (in AFY)**

<b>Single Dry-Year MWD Supply Capability and Projected Demands</b>					
Fiscal Year	2015	2020	2025	2030	2035
Capability of Current Supplies	2,457,000	2,782,000	2,977,000	2,823,000	2,690,000
Projected Demands	2,171,000	2,162,000	2,201,000	2,254,000	2,319,000
Projected Surplus	286,000	620,000	776,000	569,000	371,000
Projected Surplus % (Proj. Surplus/Proj. Demands)	13%	29%	35%	25%	16%
Supplies under Development	762,000	862,000	1,036,000	1,036,000	1,036,000
Potential Surplus	1,048,000	1,482,000	1,812,000	1,605,000	1,407,000
Potential Surplus % (Potential Surplus/Proj. Demands)	48%	69%	82%	71%	61%
<b>Multiple Dry-Year MWD Supply Capability and Projected Demands</b>					
Fiscal Year	2015	2020	2025	2030	2035
Capability of Current Supplies	2,248,000	2,417,000	2,520,000	2,459,000	2,415,000
Projected Demands	2,236,000	2,188,000	2,283,000	2,339,000	2,399,000
Projected Surplus	12,000	229,000	237,000	120,000	16,000
Projected Surplus % (Proj. Surplus/Proj. Demands)	1%	10%	10%	5%	1%
Supplies under Development	404,000	553,000	733,000	755,000	755,000
Potential Surplus	416,000	782,000	970,000	875,000	771,000
Potential Surplus % (Potential Surplus/Proj. Demands)	19%	36%	42%	37%	32%
<b>Average Year MWD Supply Capability and Projected Demands</b>					
Fiscal Year	2015	2020	2025	2030	2035
Capability of Current Supplies	3,485,000	3,810,000	4,089,000	3,947,000	3,814,000
Projected Demands	2,006,000	1,933,000	1,985,000	2,049,000	2,106,000
Projected Surplus	1,479,000	1,877,000	2,104,000	1,898,000	1,708,000
Projected Surplus % (Proj. Surplus/Proj. Demands)	74%	97%	106%	93%	81%
Supplies under Development	588,000	689,000	1,051,000	1,051,000	1,051,000
Potential Surplus	2,067,000	2,566,000	3,155,000	2,949,000	2,759,000
Potential Surplus % (Potential Surplus/Proj. Demands)	103%	133%	159%	144%	131%

Source: MWD 2010 Regional Urban Water Management Plan Tables 2-9 to 2-11.

including supplies under development, the potential surplus increases to between 19 percent and 159 percent of projected demand.

As part of the implementation of MWD's IRP, MWD and its member agencies worked together to develop MWD's Water Surplus and Drought Management Plan (WSDM Plan) in 1999. The WSDM Plan established broad water resource management strategies to ensure MWD's ability to meet full service demands at all

times and provides principles for supply allocation if the need should ever arise. The WSDM Plan splits MWD's resource actions into two major categories: Surplus Actions and Shortage Actions. The Shortage Actions of the WSDM Plan are split into three sub-categories: Shortage, Severe Shortage, and Extreme Shortage. Under Shortage conditions, MWD will make withdrawals from storage and interrupt long-term groundwater basin replenishment deliveries. Under Severe Shortage conditions, MWD will call for



extraordinary drought conservation in the form of voluntary savings from retail customers, interrupt 30 percent of deliveries to Agricultural Water Program users, call on its option transfer water, and purchase water on the spot market. The overall objective of MWD's IRP and WSDM Plan is to ensure that shortage allocations of MWD water supplies are not required.

Under Extreme Shortage conditions, MWD allocates supplies to its member agencies in accordance with its Water Supply Allocation Plan (WSAP). If shortage allocations are required, MWD will rely on the calculations established in its WSAP adopted in 2008. The plan equitably allocates shortages among its member agencies based on need with adjustments for growth, local investments, changes in supply conditions, demand hardening, and water conservation programs.

### **11.2.7 Potential Supplies**

---

Other planned and potential water supplies that LADWP is exploring include capturing stormwater for reuse and infiltration leading to increased groundwater production (see Chapter 7). The beneficial reuse of stormwater presents significant opportunity and the development of these supplies will offset the need to import additional supplemental supplies from MWD. The City must also reduce pollutants in impaired receiving waters (rivers, creeks, and beaches in the Santa Monica and Los Angeles watersheds) as required by the Clean Water Act. By managing urban runoff during dry and wet periods, this pollution will be reduced.

Traditional ways of managing urban runoff would be to divert the runoff into existing wastewater treatment plants and/or build satellite treatment plants specifically designed to treat

urban runoff. During the City's IRP process, stakeholders expressed the desire to examine other ways to manage runoff that would reduce pollution and provide for other benefits such as water supply and open space. These methods involve local and regional storage of wet weather runoff for groundwater infiltration, on-site storage and recovery of wet weather runoff for irrigation using cisterns and other devices, and reuse of treated dry weather effluent for irrigation (much like recycled water). As an outgrowth of the City's IRP, neighborhood recharge concept efforts are moving from the conceptual stage visualized in the IRP to actual projects in the City to infiltrate wet weather runoff as close as possible to the point of origin with multiple projects either complete, under construction, or in final design.

Under average weather conditions LADWP is projecting stormwater capture and reuse in 2015 could reach 2,000 AFY and increase to 10,000 AFY by 2035. Additionally, increased groundwater production from stormwater infiltration will potentially be 15,000 AFY in 2035. This increased groundwater production potential is contingent on modifying the court judgment which governs extractions from the San Fernando Groundwater Basin. If these resources reach fruition, LADWP will be able to reduce imported supplies purchased from MWD by 25,000 AFY in 2035 under average weather conditions.

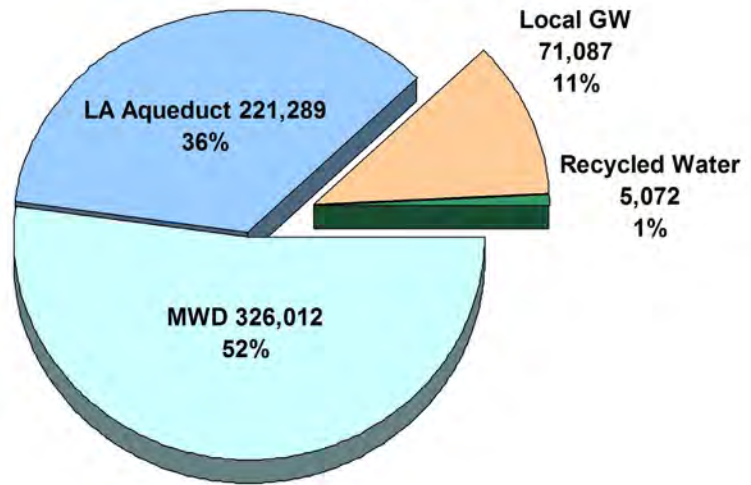
### **11.2.8 Service Area Reliability Assessment**

---

To determine the overall service area reliability, LADWP defined three hydrologic conditions: average year (50-year average hydrology from FY 1956/57 to 2005/06 ); single dry year (such as a repeat of the FY 1990/91 drought); and multi-dry year period (such as a repeat of FY1988/89 to FY1992/93). The average

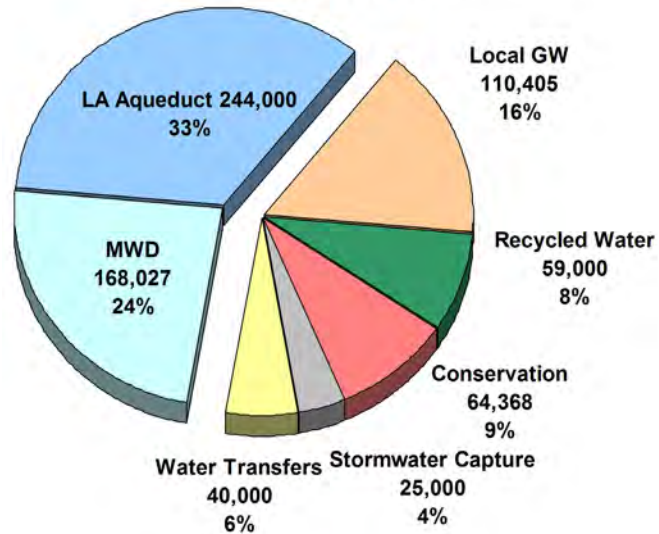
**Exhibit 11C**  
**LADWP Supply Reliability FYE 2006-2010 Average**

**FYE 2006 - 2010 Average**  
**Total - 621,700 AFY**



**Exhibit 11D**  
**LADWP Supply Reliability Under Average Weather**  
**Conditions in Fiscal Year 2034-35**

**Fiscal Year 2034 - 35**  
**Total - 710,800 AFY**



Note: Charts do not reflect approximately 100,000 AF of existing conservation

year demand is based on the forecasted median demand as shown in Exhibit 2J. Weather patterns and water demands were further studied to determine single dry year demand and multi-dry year demands. The single dry year demand is estimated to be 6 percent higher than the forecasted median demand. The multi-dry year demands are increased above the forecasted median demands

by the following percentages: 1st year – 4 percent, 2nd year – 5 percent, 3rd year – 6 percent, 4th year – 0 percent, and 5th year – 2 percent.

The water supply reliability summaries are shown in Exhibit 11C for the 5-year average from FY 2005/06 to FY 2009/10 and in Exhibit 11 D for FY 2034/35 under average weather conditions, with new

water conservation shown as a supply source. The exhibits show that the City's reliance on MWD supply will decrease from 52 percent to 24 percent by FY 2034/35 while the combined imported supplies of LAA and MWD water will decrease from 88 percent to 57 percent by FY 2034/35. The locally-developed supplies will increase from 12 percent to 43 percent by FY 2034/35.

Exhibits 11E and 11F tabulate the service reliability assessment for normal and

single dry year conditions, respectively. Exhibits 11G through 11K show reliability assessments in five year increments from 2010 to 2035 with each five year period assuming that a multiple dry year condition occurs. For these reliability tables, existing water conservation has been already subtracted from projected demands, but new water conservation is included as a supply source. Demands are met by the available supplies under all scenarios.

**Exhibit 11E**  
**Service Area Reliability Assessment for Average Weather Year**

Demand and Supply Projections (in acre-feet)	FY2009-10 Actual	Average Weather Conditions (FY 1956/57 to 2005/06) Fiscal Year Ending on June 30				
		2015	2020	2025	2030	2035
<b>Total Demand</b>	<b>555,477</b>	<b>614,800</b>	<b>652,000</b>	<b>675,600</b>	<b>701,200</b>	<b>710,800</b>
<b>Existing / Planned Supplies</b>						
Los Angeles Aqueduct <sup>1</sup>	199,739	252,000	250,000	248,000	246,000	244,000
Groundwater <sup>2</sup>	76,982	40,500	96,300	111,500	111,500	110,405
Conservation	8,178	14,180	27,260	40,340	53,419	64,368
Recycled Water						
- Irrigation and Industrial Use	6,703	20,000	20,400	27,000	29,000	29,000
- Groundwater Replenishment	0	0	0	15,000	22,500	30,000
Water Transfers	0	40,000	40,000	40,000	40,000	40,000
Subtotal	291,602	366,680	433,960	481,840	502,419	517,773
<b>MWD Water Purchases</b> With Existing/Planned Supplies	263,875	248,120	218,040	193,760	198,781	193,027
<b>Total Supplies</b>	<b>555,477</b>	<b>614,800</b>	<b>652,000</b>	<b>675,600</b>	<b>701,200</b>	<b>710,800</b>
<b>Potential Supplies</b>						
Stormwater Capture						
- Capture and Reuse (Harvesting)	0	2,000	4,000	6,000	8,000	10,000
- Increased Groundwater Production (Recharge)	0	0	2,000	4,000	8,000	15,000
Subtotal	0	2,000	6,000	10,000	16,000	25,000
<b>MWD Water Purchases</b> With Existing/Planned/Potential Supplies	263,875	246,120	212,040	183,760	182,781	168,027
<b>Total Supplies</b>	<b>555,477</b>	<b>614,800</b>	<b>652,000</b>	<b>675,600</b>	<b>701,200</b>	<b>710,800</b>

<sup>1</sup> Los Angeles Aqueduct supply is estimated to decrease 0.1652% per year due to climate change impacts.

<sup>2</sup> North Hollywood/Rinaldi-Toluca Treatment Complex is expected to be in operation in FY 2019-20. Tujunga Groundwater Treatment Plant is expected to be in operation in 2020-21. Storage credit of 5,000 afy will be used to maximize the pumping in FY 2020-21 and thereafter. Sylmar Basin production was increased to 4,500 AFY from FY 2014-15 to FY 2029-30 to avoid the expiration of stored water credits, then go back to its entitlement of 3,405 AFY in FY 2030-31.

**Exhibit 11F**  
**Service Area Reliability Assessment for Single Dry Year**

Demand and Supply Projections (in acre-feet)	FY2009-10 Actual	Single Dry Year (FY1990-91) Fiscal Year Ending on June 30				
		2015	2020	2025	2030	2035
<b>Total Demand</b>	<b>555,477</b>	<b>651,700</b>	<b>691,100</b>	<b>716,100</b>	<b>743,200</b>	<b>753,400</b>
<b>Existing / Planned Supplies</b>						
Los Angeles Aqueduct <sup>1</sup>	199,739	48,520	48,120	47,720	47,330	46,940
Groundwater <sup>2</sup>	76,982	40,500	96,300	111,500	111,500	110,405
Conservation	8,178	14,180	27,260	40,340	53,419	64,368
Recycled Water						
- Irrigation and Industrial Use	6,703	20,000	20,400	27,000	29,000	29,000
- Groundwater Replenishment	0	0	0	15,000	22,500	30,000
Water Transfers	0	40,000	40,000	40,000	40,000	<u>40,000</u>
Subtotal	291,602	163,200	232,080	281,560	303,749	320,713
<b>MWD Water Purchases With Existing/Planned Supplies</b>	263,875	488,500	459,020	434,540	439,451	432,687
<b>Total Supplies</b>	<b>555,477</b>	<b>651,700</b>	<b>691,100</b>	<b>716,100</b>	<b>743,200</b>	<b>753,400</b>
<b>Potential Supplies</b>						
Stormwater Capture						
- Capture and Reuse (Harvesting)	0	2,000	4,000	6,000	8,000	10,000
- Increased Groundwater Production (Recharge)	0	0	2,000	4,000	8,000	<u>15,000</u>
Subtotal	0	2,000	6,000	10,000	16,000	25,000
<b>MWD Water Purchases With Existing/Planned/Potential Supplies</b>	263,875	486,500	453,020	424,540	423,451	407,687
<b>Total Supplies</b>	<b>555,477</b>	<b>651,700</b>	<b>691,100</b>	<b>716,100</b>	<b>743,200</b>	<b>753,400</b>

<sup>1</sup> Los Angeles Aqueduct supply is estimated to decrease 0.1652% per year due to climate change impacts.

<sup>2</sup> North Hollywood/Rinaldi-Toluca Treatment Complex is expected to be in operation in FY 2019-20. Tujunga Groundwater Treatment Plant is expected to be in operation in 2020-21. Storage credit of 5,000 afy will be used to maximize the pumping in FY 2020-21 and thereafter. Sylmar Basin production was increased to 4,500 AFY from FY 2014-15 to FY 2029-30 to avoid the expiration of stored water credits, then go back to its entitlement of 3,405 AFY in FY 2030-31.

**Exhibit 11G**  
**Service Area Reliability Assessment for Multi-Dry Years (2011-2015)**

Demand and Supply Projections (in acre-feet)	FY2009-10 Actual	Multiple Dry Years (FY1988-89 to FY1992-93) Fiscal Year Ending on June 30				
		2011	2012	2013	2014	2015
<b>Total Demand</b>	<b>555,477</b>	<b>590,000</b>	<b>608,200</b>	<b>626,500</b>	<b>602,900</b>	<b>627,100</b>
<b>Existing / Planned Supplies</b>						
Los Angeles Aqueduct <sup>1</sup>	199,739	86,330	98,560	48,520	94,360	105,770
Groundwater <sup>2</sup>	76,982	61,090	53,660	46,260	47,300	40,500
Conservation	8,178	9,380	10,580	11,780	12,980	14,180
Recycled Water						0
- Irrigation and Industrial Use	6,703	7,500	8,300	9,000	15,500	20,000
- Groundwater Replenishment	0	0	0	0	0	0
Water Transfers	0	0	0	0	0	40,000
Subtotal	291,602	164,300	171,100	115,560	170,140	220,450
<b>MWD Water Purchases With Existing/Planned Supplies</b>	263,875	425,700	437,100	510,940	432,760	406,650
<b>Total Supplies</b>	<b>555,477</b>	<b>590,000</b>	<b>608,200</b>	<b>626,500</b>	<b>602,900</b>	<b>627,100</b>
<b>Potential Supplies</b>						
Stormwater Capture						
- Capture and Reuse (Harvesting)	0	0	0	0	0	2,000
- Increased Groundwater Production (Recharge)	0	0	0	0	0	0
Subtotal	0	0	0	0	0	2,000
<b>MWD Water Purchases With Existing/Planned/Potential Supplies</b>	263,875	425,700	437,100	510,940	432,760	404,650
<b>Total Supplies</b>	<b>555,477</b>	<b>590,000</b>	<b>608,200</b>	<b>626,500</b>	<b>602,900</b>	<b>627,100</b>

<sup>1</sup> Los Angeles Aqueduct supply is estimated to decrease 0.1652% per year due to climate change impacts.

<sup>2</sup> North Hollywood/Rinaldi-Toluca Treatment Complex is expected to be in operation in FY 2019-20. Tujunga Groundwater Treatment Plant is expected to be in operation in 2020-21. Storage credit of 5,000 afy will be used to maximize the pumping in FY 2020-21 and thereafter. Sylmar Basin production was increased to 4,500 AFY from FY 2014-15 to FY 2029-30 to avoid the expiration of stored water credits, then go back to its entitlement of 3,405 AFY in FY 2030-31.

**Exhibit 11H**  
**Service Area Reliability Assessment for Multi-Dry Years (2016-2020)**

Demand and Supply Projections (in acre-feet)	Multiple Dry Years (FY1988-89 to FY1992-93) Fiscal Year Ending on June 30				
	2016	2017	2018	2019	2020
<b>Total Demand</b>	<b>647,100</b>	<b>661,200</b>	<b>675,400</b>	<b>644,600</b>	<b>665,100</b>
<b>Existing / Planned Supplies</b>					
Los Angeles Aqueduct <sup>1</sup>	86,330	98,560	48,520	94,360	105,770
Groundwater <sup>2</sup>	37,350	37,350	37,350	42,280	96,300
Conservation	16,800	19,410	22,030	24,640	27,260
Recycled Water					0
- Irrigation and Industrial Use	20,000	20,200	20,300	20,400	20,400
- Groundwater Replenishment	0	0	0	0	0
Water Transfers	40,000	<u>40,000</u>	<u>40,000</u>	<u>40,000</u>	<u>40,000</u>
Subtotal	200,480	215,520	168,200	221,680	289,730
<b>MWD Water Purchases</b> With Existing/Planned Supplies	446,620	445,680	507,200	422,920	375,370
<b>Total Supplies</b>	<b>647,100</b>	<b>661,200</b>	<b>675,400</b>	<b>644,600</b>	<b>665,100</b>
<b>Potential Supplies</b>					
Stormwater Capture					
- Capture and Reuse (Harvesting)	2,400	2,800	3,200	3,600	4,000
- Increased Groundwater Production (Recharge)	<u>400</u>	<u>800</u>	<u>1,200</u>	<u>1,600</u>	<u>2,000</u>
Subtotal	2,800	3,600	4,400	5,200	6,000
<b>MWD Water Purchases</b> With Existing/Planned/Potential Supplies	443,820	442,080	502,800	417,720	369,370
<b>Total Supplies</b>	<b>647,100</b>	<b>661,200</b>	<b>675,400</b>	<b>644,600</b>	<b>665,100</b>

<sup>1</sup> Los Angeles Aqueduct supply is estimated to decrease 0.1652% per year due to climate change impacts.

<sup>2</sup> North Hollywood/Rinaldi-Toluca Treatment Complex is expected to be in operation in FY 2019-20. Tujunga Groundwater Treatment Plant is expected to be in operation in 2020-21. Storage credit of 5,000 afy will be used to maximize the pumping in FY 2020-21 and thereafter. Sylmar Basin production was increased to 4,500 AFY from FY 2014-15 to FY 2029-30 to avoid the expiration of stored water credits, then go back to its entitlement of 3,405 AFY in FY 2030-31.

**Exhibit 11I**  
**Service Area Reliability Assessment for Multi-Dry Years (2021-2025)**

Demand and Supply Projections (in acre-feet)	Multiple Dry Years (FY1988-89 to FY1992-93) Fiscal Year Ending on June 30				
	2021	2022	2023	2024	2025
<b>Total Demand</b>	<b>683,000</b>	<b>694,500</b>	<b>706,100</b>	<b>670,900</b>	<b>689,100</b>
<b>Existing / Planned Supplies</b>					
Los Angeles Aqueduct <sup>1</sup>	86,330	98,560	48,520	94,360	105,770
Groundwater <sup>2</sup>	111,500	111,500	111,500	111,500	111,500
Conservation	29,880	32,490	35,110	37,720	40,340
Recycled Water					0
- Irrigation and Industrial Use	20,400	21,000	23,000	25,000	27,000
- Groundwater Replenishment		15,000	15,000	15,000	15,000
Water Transfers	40,000	<u>40,000</u>	<u>40,000</u>	<u>40,000</u>	<u>40,000</u>
Subtotal	288,110	318,550	273,130	323,580	339,610
<b>MWD Water Purchases</b> With Existing/Planned Supplies	394,890	375,950	432,970	347,320	349,490
<b>Total Supplies</b>	<b>683,000</b>	<b>694,500</b>	<b>706,100</b>	<b>670,900</b>	<b>689,100</b>
<b>Potential Supplies</b>					
Stormwater Capture					
- Capture and Reuse (Harvesting)	4,400	4,800	5,200	5,600	6,000
- Increased Groundwater Production (Recharge)	<u>2,400</u>	<u>2,800</u>	<u>3,200</u>	<u>3,600</u>	<u>4,000</u>
Subtotal	6,800	7,600	8,400	9,200	10,000
<b>MWD Water Purchases</b> With Existing/Planned/Potential Supplies	388,090	368,350	424,570	338,120	339,490
<b>Total Supplies</b>	<b>683,000</b>	<b>694,500</b>	<b>706,100</b>	<b>670,900</b>	<b>689,100</b>

<sup>1</sup> Los Angeles Aqueduct supply is estimated to decrease 0.1652% per year due to climate change impacts.

<sup>2</sup> North Hollywood/Rinaldi-Toluca Treatment Complex is expected to be in operation in FY 2019-20. Tujunga Groundwater Treatment Plant is expected to be in operation in 2020-21. Storage credit of 5,000 afy will be used to maximize the pumping in FY 2020-21 and thereafter. Sylmar Basin production was increased to 4,500 AFY from FY 2014-15 to FY 2029-30 to avoid the expiration of stored water credits, then go back to its entitlement of 3,405 AFY in FY 2030-31.

**Exhibit 11J**  
**Service Area Reliability Assessment for Multi-Dry Years (2026-2030)**

Demand and Supply Projections (in acre-feet)	Multiple Dry Years (FY1988-89 to FY1992-93) Fiscal Year Ending on June 30				
	2026	2027	2028	2029	2030
<b>Total Demand</b>	<b>707,900</b>	<b>720,100</b>	<b>732,400</b>	<b>696,100</b>	<b>715,200</b>
<b>Existing / Planned Supplies</b>					
Los Angeles Aqueduct <sup>1</sup>	86,330	98,560	48,520	94,360	105,770
Groundwater <sup>2</sup>	111,500	111,500	111,500	111,500	111,500
Conservation	42,960	45,570	48,190	50,800	53,420
Recycled Water					0
- Irrigation and Industrial Use	27,500	28,000	28,500	29,000	29,000
- Groundwater Replenishment	16,500	18,000	19,500	21,000	22,500
Water Transfers	40,000	40,000	40,000	40,000	40,000
Subtotal	324,790	341,630	296,210	346,660	362,190
<b>MWD Water Purchases With Existing/Planned Supplies</b>	383,110	378,470	436,190	349,440	353,010
<b>Total Supplies</b>	<b>707,900</b>	<b>720,100</b>	<b>732,400</b>	<b>696,100</b>	<b>715,200</b>
<b>Potential Supplies</b>					
Stormwater Capture					
- Capture and Reuse (Harvesting)	6,400	6,800	7,200	7,600	8,000
- Increased Groundwater Production (Recharge)	4,800	5,600	6,400	7,200	8,000
Subtotal	11,200	12,400	13,600	14,800	16,000
<b>MWD Water Purchases With Existing/Planned/Potential Supplies</b>	371,910	366,070	422,590	334,640	337,010
<b>Total Supplies</b>	<b>707,900</b>	<b>720,100</b>	<b>732,400</b>	<b>696,100</b>	<b>715,200</b>

<sup>1</sup> Los Angeles Aqueduct supply is estimated to decrease 0.1652% per year due to climate change impacts.

<sup>2</sup> North Hollywood/Rinaldi-Toluca Treatment Complex is expected to be in operation in FY 2019-20. Tujunga Groundwater Treatment Plant is expected to be in operation in 2020-21. Storage credit of 5,000 afy will be used to maximize the pumping in FY 2020-21 and thereafter. Sylmar Basin production was increased to 4,500 AFY from FY 2014-15 to FY 2029-30 to avoid the expiration of stored water credits, then go back to its entitlement of 3,405 AFY in FY 2030-31.



**Exhibit 11K**  
**Service Area Reliability Assessment for Multi-Dry Years (2031-2035)**

Demand and Supply Projections (in acre-feet)	Multiple Dry Years (FY1988-89 to FY1992-93) Fiscal Year Ending on June 30				
	2031	2032	2033	2034	2035
<b>Total Demand</b>	<b>731,200</b>	<b>740,300</b>	<b>749,300</b>	<b>708,800</b>	<b>725,000</b>
Existing / Planned Supplies					
Los Angeles Aqueduct <sup>1</sup>	86,330	98,560	48,520	94,360	105,770
Groundwater <sup>2</sup>	110,405	110,405	110,405	110,405	110,405
Conservation	55,600	57,800	60,000	62,200	64,368
Recycled Water					0
- Irrigation and Industrial Use	29,000	29,000	29,000	29,000	29,000
- Groundwater Replenishment	24,000	25,500	27,000	28,500	30,000
Water Transfers	40,000	<u>40,000</u>	<u>40,000</u>	<u>40,000</u>	<u>40,000</u>
Subtotal	345,335	361,265	314,925	364,465	379,543
<b>MWD Water Purchases</b> With Existing/Planned Supplies	385,865	379,035	434,375	344,335	345,457
<b>Total Supplies</b>	<b>731,200</b>	<b>740,300</b>	<b>749,300</b>	<b>708,800</b>	<b>725,000</b>
<b>Potential Supplies</b>					
Stormwater Capture					
- Capture and Reuse (Harvesting)	8,400	8,800	9,200	9,600	10,000
- Increased Groundwater Production (Recharge)	<u>9,400</u>	<u>10,800</u>	<u>12,200</u>	<u>13,600</u>	<u>15,000</u>
Subtotal	17,800	19,600	21,400	23,200	25,000
<b>MWD Water Purchases</b> With Existing/Planned/Potential Supplies	368,065	359,435	412,975	321,135	320,457
<b>Total Supplies</b>	<b>731,200</b>	<b>740,300</b>	<b>749,300</b>	<b>708,800</b>	<b>725,000</b>

<sup>1</sup> Los Angeles Aqueduct supply is estimated to decrease 0.1652% per year due to climate change impacts.

<sup>2</sup> North Hollywood/Rinaldi-Toluca Treatment Complex is expected to be in operation in FY 2019-20. Tujunga Groundwater Treatment Plant is expected to be in operation in 2020-21. Storage credit of 5,000 afy will be used to maximize the pumping in FY 2020-21 and thereafter. Sylmar Basin production was increased to 4,500 AFY from FY 2014-15 to FY 2029-30 to avoid the expiration of stored water credits, then go back to its entitlement of 3,405 AFY in FY 2030-31.

## 11.3 Water Shortage Contingency Plan

---

The Los Angeles City Municipal Code Chapter XII, Article I, Emergency Water Conservation Plan is the City's water shortage contingency plan (see Appendix I). It was developed to provide for a sufficient and continuous supply of water in case of a water supply shortage in the service area. There are two scenarios that can cause a water shortage: 1) a severe hydrologic dry period affecting surface and groundwater supplies and 2) a catastrophic event that severs major conveyance and/or distribution pipelines serving water to the City. The following discusses LADWP's compliance with the UWMP Act as outlined in Section 10632 (a) (1) through (9) of the California Water Code.

### 11.3.1 Stages of Action – 10632 (a) (1)

---

As set forth in the Emergency Water Conservation Plan, the City has conservation phases or stages of action that can be undertaken in response to water supply shortages. Although there are no specific percentages of water shortage levels assigned to each phase, LADWP continually monitors water supplies and demands. As necessary, LADWP's Board of Water and Power Commissioners makes recommendations to the Mayor and City Council on the suggested conservation phase to address the water shortage conditions. The implementation of progressive conservation phases will cope with up to a 50 percent reduction in water supplies and roughly correspond to the water shortage percentages described below:

#### **No Shortage, Phase I (0 percent)**

Phase I prohibited uses of water are in effect at all times within the City. These

prohibited uses, defined in article 10632 (a) (4) (see section 11.3.4), are intended to eliminate waste and increase public awareness of the need to conserve water. There are further stages of compounding actions in addition to the Phase I prohibited uses that might be imposed. Phase II to Phase V progressively responds to different severities of shortage and implement additional prohibited uses of water.

#### **Moderate Shortage, Phase II (roughly corresponding to >0 to 15 percent)**

1. Should Phase II be implemented, uses applicable to Phase I shall continue to be applicable, except as specifically provided herein.
2. No landscape irrigation shall be permitted on any day other than Monday, Wednesday, or Friday for odd-numbered street addresses and Tuesday, Thursday, or Sunday for even-numbered street addresses. Street addresses ending in ½ or any fraction shall conform to the permitted uses for the last whole number in the address. Watering times shall be limited to: (a) Non-conserving nozzles (spray head sprinklers and bubblers) – no more than eight minutes per watering day per station for a total of 24 minutes per week; (b) Conserving nozzles (standard rotors and multi-stream rotary heads) – no more than 15 minutes per cycle and up to two cycles per watering day per station for a total of 90 minutes per week.
3. Upon written notice to LADWP, irrigation of sports fields may deviate from non-watering days to maintain play areas and accommodate event schedules; however, to be eligible for this means of compliance, a customer must reduce his overall monthly water use by LADWP's Board of Water and Power Commissioners' adopted degree of shortage plus an additional 5 percent from the customer baseline water usage within 30 days.

4. Upon written notice to LADWP, large landscape areas may deviate from the non-watering days by meeting the following requirements (1) must have approved weather-based irrigation controllers registered with LADWP (eligible weather-based irrigation controllers are those approved by MWD or the Irrigation Association Smart Water Application Technologies (SWAT) initiative (2) must reduce overall monthly water use by LADWP's Board of Water and Power Commissioners' adopted degree of shortage plus an additional 5 percent from the customer baseline water usage within 30 days; and (3) must use recycled water if it is available from LADWP.
5. These provisions do not apply to drip irrigation supplying water to a food source or to hand-held hose watering of vegetation, if the hose is equipped with a self-closing water shut-off device, which is allowed everyday during Phase II except between the hours of 9:00 am and 4:00 pm.

**Severe Shortage, Phase III (roughly corresponding to 15 to 20 percent shortage)**

1. Should Phase III be implemented, uses applicable to Phases I and II shall continue to be applicable, except as specifically provided herein.
2. No landscape irrigation shall be permitted on any day other than Monday for odd-numbered street addresses and Tuesday for even-numbered street addresses. Street addresses ending in ½ or any fraction shall conform to the permitted uses for the last whole number in the address.
3. No washing of vehicles allowed except at commercial car wash facilities.
4. No filling of residential swimming pools and spas with potable water.
5. Upon written notice to LADWP,

irrigation of sports fields may deviate from the specific non-watering days and be granted one additional water day (for a total of two watering days allowed). To be eligible for this means of compliance, a customer must reduce his overall monthly water use by LADWP's Board of Water and Power Commissioners' adopted degree of shortage plus an additional 10 percent from the customer baseline water usage within 30 days.

6. Upon written notice to LADWP, large landscape areas may deviate from the specific non-watering days and be granted one additional watering day (for a total of two watering days allowed) by meeting the following requirements (1) must have approved weather-based irrigation controllers registered with LADWP (eligible weather-based irrigation controllers are those approved by MWD or the Irrigation Association Smart Water Application Technologies (SWAT) initiative (2) must reduce overall monthly water use by LADWP's Board of Water and Power Commissioners' adopted degree of shortage plus an additional 10 percent from the customer baseline water usage within 30 days; and (3) must use recycled water if it is available from LADWP.
7. These provisions do not apply to drip irrigation supplying water to a food source or to hand-held hose watering of vegetation, if the hose is equipped with a self-closing water shut-off device, which is allowed everyday during Phase III except between the hours of 9:00 am and 4:00 pm.

**Critical Shortage, Phase IV (roughly corresponding to 20 to 35 percent shortage)**

1. Should Phase IV be implemented, uses applicable to Phases I, II, and III shall continue to be applicable, except as specifically provided herein.
2. No landscape irrigation allowed.

**Super Critical Shortage, Phase V  
(roughly corresponding to 35 to 50  
percent shortage)**

1. Phase I, II, III, and IV shall continue to remain in effect.
2. The Board of Water and Power Commissioners is hereby authorized to implement additional prohibited uses of water based on the water supply situation. Any additional prohibitions shall be published at least once in a daily newspaper of general circulation and shall become effective immediately upon such publication and shall remain in effect until cancelled.

**11.3.2 Driest Three-Year  
Supply – 10632 (a) (2)**

In the event that three consecutive dry-years curtailing the City’s LAA System deliveries should follow the 2010 water supply conditions, LADWP will rely on increased groundwater pumping and purchases from MWD to meet City water demands. This particular sequence is quantified in Exhibit 11L, including relevant assumptions.

During such severe drought periods, the City’s supplemental water supplier MWD will use its WSAP in conjunction with the framework developed in its WSDM Plan. Developed by MWD with substantial input from its member agencies, the WSDM

**Exhibit 11L  
Driest Three-Year Water Supply Sequence**

Demand and Supply Projections (in acre-feet)	FY2009-10 Actual	Followed by Repeat of Driest Three Consecutive Years FY1958/59 to 1960/61 Hydrology Fiscal Year Ending on June 30		
		2011	2012	2013
<b>Total Demand</b>	<b>555,447</b>	<b>590,000</b>	<b>608,200</b>	<b>626,500</b>
<b>Existing / Planned Supplies</b>				
Los Angeles Aqueduct	199,739	104,530	50,849	59,382
Groundwater	76,982	61,090	53,660	46,260
Conservation	8,178	9,380	10,580	11,780
Recycled Water				
- Irrigation and Industrial Use	6,703	7,500	8,300	9,000
- Groundwater Replenishment	0	0	0	0
Water Transfers	0	0	0	0
Subtotal	291,602	182,500	123,389	126,422
<b>MWD Water Purchases With Existing/Planned Supplies</b>	263,845	407,500	484,811	500,078
<b>Total Supplies</b>	<b>555,447</b>	<b>590,000</b>	<b>608,200</b>	<b>626,500</b>

Assumptions

1. Driest three consecutive years on record in LAA watershed (FY1958-59 to FY1960-61) averaged 28 percent of normal runoff.
2. LAA deliveries reflect increased releases for environmental restoration in the Owens Valley and Mono Basin.
3. Dry year demands are 5 percent greater than normal year demands
4. MWD’s Water Surplus and Drought Management Plan actions are sufficient to meet LADWP demands.

Plan provides for the WSAP's needs-based allocation strategy, and establishes priorities for the use of MWD's water supplies to achieve retail reliability.

The following are actions that could be taken by MWD, in accordance with their WSDM Plan, to augment its water supplies prior to implementation of any WSAP drought allocation action:

1. Draw on Diamond Valley Lake storage.
2. Draw on out-of-region storage in Semitropic and Arvin-Edison Groundwater Banks.
3. Reduce/suspend local groundwater replenishment deliveries.
4. Draw on contractual groundwater storage programs in MWD's service area.
5. Draw on State Water Project terminal reservoir storage (per Monterey Agreement).
6. Call for voluntary conservation and public education.
7. Reduce deliveries from MWD's Interim Agricultural Water Program.
8. Call on water transfer options contracts.
9. Purchase transfers on the spot market.
10. Allocate imported water in accordance with the WSAP if necessary.

In 2008 MWD adopted the WSAP which is designed to allocate supplies among its member agencies in a fair and efficient manner. The WSAP establishes the formula for calculating member agency allocations if MWD cannot meet firm demands in a given year.

### 11.3.3 Catastrophic Supply Interruption Plan – 10632 (a) (3)

---

#### Seismic Assessment of Major Imported Supplies

MWD performed a seismic risk assessment of its water distribution network to evaluate the impacts of seismic activity in the greater Southern California area. For MWD, there are three sources of imported water to the region: the Colorado River Aqueduct (CRA), the East SWP branch, and the West SWP branch. Each source was evaluated for the potential of failure during a seismic event. The SWP East branch is considered more vulnerable because the California Aqueduct's alignment follows the San Andreas fault-line and crosses over the San Andreas Fault at multiple locations. The SWP West branch and CRA are somewhat less vulnerable due to their proximity to the San Andreas fault-line, although the San Andreas Fault crosses all aqueducts entering the Southern California region. It crosses the SWP East branch three times, the SWP West branch once, the CRA once, and the LAA once.

LADWP investigated the ability of MWD to deliver Colorado River water into the west San Fernando Valley in the event that SWP supplies and LAA supplies are interrupted. This investigation included the two MWD service areas adjacent to the West San Fernando Valley, the Calleguas and Las Virgenes Municipal Water Districts. If imported supply from the SWP and LAA are severed, MWD has prolonged emergency storage in Castaic and Pyramid Lakes. Given the proximity of MWD infrastructure to seismic activity on the San Andreas Fault, MWD staff predicts that if Castaic and Pyramid Lakes become disconnected from the City emergency repairs can be made to ensure that supply is not interrupted for an extended period of time. In a worst case scenario, if these sources are cut off from the City, 50 cubic feet per second of CRA water could be moved through

MWD's system to serve the west San Fernando Valley, Calleguas MWD, and Las Virgines MWD until repairs to the MWD facilities could be made. On-call contractors working around the clock could be deployed to repair seismic damage in as short as a two-week time period depending on the severity and location of the break(s). Due to these risks MWD's current storage policy is to maintain maximum emergency storage in both Pyramid and Castaic Lakes.

### **Emergency Response Plan**

LADWP has Emergency Response Plans (ERPs revised January 2011) in place to restore water service for essential use in the City if a disaster, such as earthquakes and power outages, should result in the temporary interruption of water supply. Department personnel responsible for water transportation, distribution, and treatment have established ERPs to guide the assessment, prioritization, and repair of City facilities that have incurred damage during a disaster.

An Emergency Operations Center (EOC) serves as a centralized point for citywide management of information about disasters and for coordination of all available resources. The EOC supports the City's Emergency Operations Organization to achieve its mission of saving lives, protecting property, and returning the City to normal operations in the event of a disaster. LADWP coordinates its efforts with the EOC and will utilize the EOC to resume water supply service after a catastrophic event.

#### **Earthquakes**

In the event of a major earthquake, LADWP has a Disaster Response Plan dedicated for the LAA in addition to its overall Emergency Response Plan. The Disaster Response Plan details procedures for operating the LAA following an earthquake in order to prevent further damage of the LAA. If the LAA is severed by seismic activity on the San Andreas fault and is temporarily unable to provide water to the City, LADWP will be able to use its water

storage in the Bouquet Reservoir to provide water supply to the City while repairs are made. In addition to this resource, if the California Aqueduct is intact south of the Neenach Pump Station (First Los Angeles Aqueduct – State Water Project Connection), arrangements may be made to transfer LAA water through this connection into the California Aqueduct for delivery to MWD. Arrangements can then be made to deliver water to the City through one of MWD's connections.

#### **Power Outages**

Most of LADWP's major pump stations have backup generators in the event a major power outage disrupts the primary energy system. Backup generators are either powered by a separate electric source or have independent diesel power. The diesel powered backup supplies are capable of running for at least 24 hours. In the event of a major power outage, all pump stations are designed to automatically switch to their backup generators to prevent disruption of water service. In addition, LADWP keeps an adequate storage supply which is able to keep the water distribution system operable until power is restored.

### **11.3.4 Mandatory Water Use Prohibitions – 10632 (a) (4)**

---

Phase I prohibited uses of the Emergency Water Conservation Plan contain 13 wasteful water use practices that are permanently prohibited for all City of Los Angeles customers. These prohibited uses are intended to eliminate waste and increase public awareness of the need to conserve water. During times of shortage, education and enforcement of the following provisions will be increased:

1. No customer shall use a water hose to wash any paved surfaces including, but not limited to, sidewalks, walkways, driveways, and parking areas, except to alleviate immediate

safety or sanitation hazards. This section shall not apply to LADWP approved water conserving spray cleaning devices. Use of water pressure devices for graffiti removal is exempt. A simple spray nozzle does not qualify as a water conserving spray cleaning device.

2. No customer shall use water to clean, fill, or maintain levels in decorative fountains, ponds, lakes, or similar structures used for aesthetic purposes unless such water is part of a recirculating system.
3. No restaurant, hotel, cafe, cafeteria, or other public place where food is sold, served, or offered for sale shall serve drinking water to any person unless expressly requested.
4. No customer shall permit water to leak from any pipe or fixture on the customer's premises; failure or refusal to affect a timely repair of any leak of which the customer knows or has reason to know shall subject said customer to all penalties for a prohibited use of water.
5. No customer shall wash a vehicle with a hose if the hose does not have a self-closing water shut-off device or device attached to it, or otherwise to allow a hose to run continuously while washing a vehicle.
6. No customer shall irrigate during periods of rain.
7. No customer shall water or irrigate lawn, landscape, or other vegetated areas between the hours of 9:00 a.m. and 4:00 p.m. During these hours, public and private golf courses greens and tees and professional sports fields may be irrigated in order to maintain play areas and accommodate event schedules. Supervised testing or repairing of irrigation systems is allowed anytime with proper signage.
8. All irrigating of landscape with potable water using spray head

sprinklers and bubblers shall be limited to no more than ten minutes per watering station per day. All irrigating of landscape with potable water using standard rotors and multi-stream rotary heads shall be limited to no more than fifteen minutes per cycle and up to two cycles per watering day per station. Exempt from these irrigation restrictions are irrigation systems using very low drip type irrigation when no emitter produces more than four gallons of water per hour and micro-sprinklers using less than fourteen gallons per hour. This provision does not apply to Schedule F water customers or water service water service that has been granted the General Provision M rate adjustment under the City's Water Rates Ordinance, subject to the Customer having complied with best management practices for irrigation approved by the Department. The 9:00 a.m. to 4:00 p.m. irrigation restriction shall apply unless specifically exempt as stated in subsection 7 of the Emergency Water Conservation Ordinance.

9. No customer shall water or irrigate any lawn, landscape, or other vegetated area in a manner that causes or allows excess or continuous flow or runoff onto an adjoining sidewalk, driveway, street, gutter, or ditch.
10. No installation of single pass cooling systems shall be permitted in buildings requesting new water service.

11. No installation of non-recirculating systems shall be permitted in new conveyor car wash and new commercial laundry systems.
12. Operators of hotels and motels shall provide guests with the option of choosing not to have towels and linens laundered daily. The hotel or motel shall prominently display notice of this option in each bathroom using clear and easily understood language. LADWP shall make suitable displays available.
13. No large landscape areas shall have irrigation systems without rain sensors that shut-off the irrigation systems. Large landscape areas with approved weather-based irrigation controllers registered with LADWP are in compliance with this requirement.

only during the high season (June 1 through October 31). Details of LADWP's water rate structure are provided in Appendix C – Water Rate Ordinance.

To provide immediate demand reductions and increase public awareness of the need to conserve water, additional measures can be phased in as the dry period continues. Included among these measures are water conservation public service announcements (through television and/or radio), billboard ads, flyer distributions, and conservation workshops. LADWP also actively participates in public exhibits to disseminate water conservation information within its service area. Conservation is a permanent and long-term ethic adopted by the City to counter the potentially adverse impacts of water supply shortages.

State law further regulates distribution of water in extreme water shortage conditions. Section 350-354 of the California Water Code states that when a governing body of a distributor of a public water supply declares a water shortage emergency within its service area, water will be allocated to meet needs for domestic use, sanitation, fire protection, and other priorities. This will be done equitably and without discrimination between customers using water for the same purpose(s).

### 11.3.5 Consumption Reduction Methods During Most Restrictive Stages – 10632 (a) (5)

---

#### Short-Term Actions

During a water shortage or emergency condition, LADWP utilizes its Emergency Water Conservation Plan (11.3.1) to decrease water use as needed based on the severity of the shortage. The Emergency Water Conservation Plan is capable of reducing water use by up to 50 percent.

In addition, LADWP's existing rate structure (enacted in 1993) serves as a basis for further reducing consumption. First tier water allotments are reduced during shortages by the degree of the shortage. For single-family residential users, the adjusted first tier allotments apply for the entire year. For other users, the adjusted first tier allotments apply

#### Long-Term Actions

LADWP's long-range water conservation program is driven by the need to continuously increase water use efficiency. This will reduce demand, extend supply, and therefore, provide greater reliability. Dry cycle experiences, public trust responsibilities, and regulatory mandates have raised the level of awareness within the City of Los Angeles of the need to approach demand reduction from a permanent and long-term perspective.

LADWP will continue to maintain and increase its existing conservation programs and pursue the development of



new and innovative programs as outlined in Chapter 3, Water Conservation with the goal of reducing potable water demands by 60,000 AFY by 2035. Emphasis continues to be placed on structural conservation for the residential and CII sectors (HETs, high-efficiency washing machine rebates, etc.) which result in permanent per capita water use reduction. Substantial efforts are also being placed on landscape water use efficiency and CII conservation opportunities. It should, however, be recognized that the ability to achieve water reduction during shortages by requesting additional voluntary measures is likely to be more difficult in the future. As customers adjust to a conservation ethic and adopt permanent measures to reduce water use, their water demands harden and become less susceptible to voluntary conservation.

### 11.3.6 Penalties for Excessive Use (Non-Compliance to Prohibited Use) – 10632 (a) (6)

---

The Emergency Water Conservation Plan sets penalties for violations of prohibited uses outlined in Sections 10632 (a) (1) and (a) (4). The penalties vary by water meter size. For water meters smaller than two inches the following penalties shall apply:

1. The first violation consists of a written warning.
2. The second violation within the preceding 12 month period will result in a surcharge in the amount of \$100 added to the customer’s water bill.
3. The third violation within the preceding 12 month period will result in a surcharge in the amount of \$200 added to the customer’s water bill.

4. The fourth violation within the preceding 12 month period will result in a surcharge in the amount of \$300 added to the customer’s water bill.
5. After a fifth violation or subsequent violation within the preceding 12 month period, LADWP may install a flow-restricting device of 1 gpm capacity for services up to 1 ½ inches in size and comparatively sized restrictors for larger services or terminate a customer’s service, in addition to the aforementioned financial surcharges. Such action shall only be taken after a hearing held by LADWP.

For water meters two inches and larger the following penalties shall apply:

1. The first violation consists of a written warning.
2. The second violation within the preceding 12 month period will result in a surcharge in the amount of \$200 added to the customer’s water bill.
3. The third violation within the preceding 12 month period will result in a surcharge in the amount of \$400 added to the customer’s water bill.
4. The fourth violation within the preceding 12 month period will result in a surcharge in the amount of \$600 added to the customer’s water bill.
5. After a fifth violation or subsequent violation within the preceding 12 month period, LADWP may install a flow-restricting device or terminate a customer’s service, in addition to the aforementioned financial surcharges. Such action shall only be taken after a hearing held by LADWP.

### 11.3.7 Analysis and Effects on Revenues and Expenditures of Reduced Sales during Shortages – 10632 (a) (7)

---

The City's Water Rate Ordinance, adopted in June 1995 and last amended in June 2008, provides a remedy to the impact of reduced water sales on revenues in the form of a Water Revenue Adjustment Factor (Adjustment). The Adjustment recovers any shortage in revenue due to variation in water sales. It is intended to support a fiscal year revenue target that is deemed sufficient to cover LADWP's essential expenses. The formula takes into account target and actual revenues as well as projected water sales to determine the appropriate Adjustment.

The Adjustment is currently limited to \$.18 per hundred-cubic-foot (one billing unit). It cannot exceed this limit unless the Board of Water and Power Commissioners determines that a surcharge in excess of \$0.18 per hundred-cubic-foot is financially required and approval from the Los Angeles City Council is obtained. The Board of Water and Power Commissioners also has the authority to reduce the factor to less than the formula-calculated amount.

A billing factor is calculated annually on January 1 and is added to the standard commodity charge. The factor is set to zero if a negative value is calculated. A Water Revenue Adjustment Account is maintained and updated each month by LADWP. This account is adjusted annually on July 1.

The City's Water Revenue Adjustment Factor ensures that resources are available to fund LADWP activities aimed at providing continuous water service to Los Angeles water users, even during periods of low water sales.

### 11.3.8 Water Shortage Contingency Resolution or Ordinance – 10632 (a) (8)

---

A draft water shortage contingency declaration resolution is shown in Exhibit 11M. Moreover, the City's Emergency Water Conservation Plan Section 121.07.B has the following conservation phase implementation procedures:

"The Department (LADWP) shall monitor and evaluate the projected supply and demand for water by its Customers monthly, and shall recommend to the Mayor and Council by concurrent written notice the extent of the conservation required by the Customers of the Department in order for the Department to prudently plan for and supply water to its Customers. The Mayor shall, in turn, independently evaluate such recommendation and notify the Council of the Mayor's determination as to the particular phase of water conservation, Phase I through Phase V, that should be implemented. Thereafter, the Mayor may, with the concurrence of the Council, order that the appropriate phase of water conservation be implemented in accordance with the applicable provisions of this Article. Said order shall be made by public proclamation and shall be published one time only in a daily newspaper of general circulation and shall become effective immediately upon such publication. The prohibited water uses for each phase shall take effect with the first full billing period commencing on or after the effective date of the public proclamation by the Mayor. In the event the Mayor independently recommends to the Council a phase of conservation different from that recommended by the Department, the Mayor shall include detailed supporting data and the reasons for the independent recommendation in the notification to the Council of the Mayor's determination as to the appropriate phase of conservation to be implemented."

The City's Water Rate Ordinance No. 170435 also has specific provisions for LADWP's Board of Water and Power Commissioners, through a resolution, to determine the degree of shortage and apply corresponding commodity charges in case of a water shortage (see Section 11.3.5 and Appendix C – Water Rate Ordinance). If a water shortage is declared, certified copies of the resolution will be transmitted to the offices of the Mayor and of the Los Angeles City Clerk, and the Los Angeles City Council for final approval. This particular water shortage act is included under Section 3 – General Provisions, Article R – Shortage Year Rates of the City's Water Rate Ordinance.

### **11.3.9 Methodology to Determine Actual Water Use Reductions during Shortages – 10632 (a) (9)**

Water use is monitored closely by LADWP throughout its service area regardless of the supply conditions. With 100 percent of its over 700,000 service connections metered, there is a high degree of accountability on the quantity of water used within the LADWP service area. Information from meter reads is collected for billing and accounting purposes, with reports prepared on a monthly basis from the data compiled. The actual

#### **Exhibit 11M Draft Water Shortage Contingency Declaration Resolution**

BE IT RESOLVED that the Board of Water and Power Commissioners (Board) recognizes that a Water Shortage Contingency Plan has been prepared and incorporated into the City of Los Angeles 2010 Urban Water Management Plan pursuant to the Urban Water Management Planning Act; the Urban Water Management Plan is on file with the Secretary of the Board; this Board has reviewed and considered the information and recommendations contained in this document, and makes the following findings and determinations:

- 1.The water supply available to the City of Los Angeles is insufficient to meet the City's normal water supply needs; and
- 2.The Department of Water and Power has developed a Water Shortage Contingency Plan for the City of Los Angeles that complies with all the requirements of the Urban Water Management Planning Act; and
- 3.The Urban Water Management Plan has been developed, adopted, and implemented pursuant to Article 3, Sections 10640 through 10645 of the Urban Water Management Planning Act; and
- 4.The Water Shortage Contingency Plan includes stages of action that can be taken in response to water supply shortages, including up to a 50 percent reduction in water supply, a driest three-year water supply scenario, mandatory water use prohibitions, and penalties for non-compliance; and
- 5.The Water Shortage Contingency Plan identifies both short-term and long-term actions to maximize water use efficiency and minimize the effects of the current water shortage as well as future water supply shortages.

BE IT FURTHER RESOLVED that this Board has adopted the Water Shortage Contingency Plan as incorporated in the Urban Water Management Plan, and declares the provisions of the Water Shortage Contingency Plan in full force and effect during the duration of this period of water shortage.

I HEREBY CERTIFY that the foregoing is a full, true, and correct copy of the resolution adopted by the Board of Water and Power Commissioners of the City of Los Angeles at its meeting held

water reductions are determined by comparing the metered water use to the normal water use under average weather condition when no mandatory water conservation is imposed. Based on these criteria, the water use level of FY 2006/07 was selected as the base year or the normal year to determine the effectiveness of water reduction measures during the recent water supply shortage.

LADWP also used a conservation model to establish a weather-normalized demand to estimate conservation efforts within the City since the early 1990s. The model estimated City water demand without conservation efforts using population and weather variables. A new conservation model was developed in 2010 to account for additional factors such as economic recession and drought conservation. This model is discussed in Chapter 2, Water Demand. The City's conservation effort is derived by comparing estimated pre-conservation demand with actual demand. Conservation efforts derived from this model are shown in Chapter 3, Water Conservation.

## 11.4 Water Supply Assessments

---

### Background

In 1994, the California Legislature enacted Water Code Section 10910 (Senate Bill 901), which requires cities and counties, as part of California Environmental Quality Act (CEQA) review, to request the applicable public water system to assess whether the system's projected water supplies were sufficient to meet a proposed development's anticipated water demand. The intent was to link the land use and water supply planning processes to ensure that developers and water supply agencies communicate early in the planning process. However, a study of projects approved by local planning agencies revealed that numerous projects

were exempted due to loopholes in the statute, and that the intent of the legislation had largely gone unfulfilled.

Subsequently, California Senate Bill (SB) 610 and SB 221, modeled after SB 901, amended State law effective January 1, 2002, to ensure that the original intent of the legislation is fulfilled. SB 610 and 221 are companion measures which seek to promote more collaborative planning between local water suppliers and cities and counties. These bills improve the link between information on water supply availability and certain land use decisions made by cities and counties. Both statutes require detailed information regarding water availability to be provided to the city and county decision-makers prior to approval of specified large development projects. Both statutes also require this detailed information be included in the administrative record that serves as the evidentiary basis for an approval action by the city or county on such projects. Both measures recognize local control and decision making regarding the availability of water for projects and the approval of projects.

Under SB 610, a water supply assessment (WSA) must be furnished to local governments for inclusion in any environmental documentation for specified types of development projects subject to CEQA. Specifically, SB 610 requires that for certain projects, the CEQA lead agency must identify a public water system that may supply water to the proposed project and request the public water system to determine the water demand associated with the project and whether such demand is included as part of the public water system's most recently adopted UWMP. If the projected water demand associated with the proposed project is accounted for in the most recently adopted UWMP, the public water system may incorporate the supporting information from the UWMP in preparing the elements of the assessment. If the proposed project's water demand is not accounted for in the most recently adopted UWMP, the WSA for the project shall include a discussion with regard to



whether the public water system's total projected water supplies available in normal, single dry, and multiple dry water years during a 20-year projection will meet the proposed project's water demand.

Per Section 10912 of the California Water Code, a project which is subject to the requirements of SB 610 includes: (1) a proposed residential development of more than 500 dwelling units; (2) a proposed shopping center or business establishment employing more than 1,000 persons or having more than 500,000 square feet of floor space; (3) a proposed commercial office building employing more than 1,000 persons or having more than 250,000 square feet of floor space; (4) a proposed hotel or motel, or both, having more than 500 rooms; (5) a proposed industrial, manufacturing, or processing plant, or industrial park planned to house more than 1,000 persons, occupying more than 40 acres of land, or having more than 650,000 square feet of floor area; (6) a mixed-use project that includes one

or more of the projects specified in this subdivision; or (7) a project that would demand an amount of water equivalent to, or greater than, the amount of water required by a 500 dwelling unit project.

The assessment would include an identification of existing water supply entitlements, water rights, or water service contracts relevant to the identified water supply for the proposed project and water received in prior years pursuant to those entitlements, rights, and contracts. If the assessment concludes that water supplies will be insufficient, plans for acquiring additional water supplies would need to be presented.

Under SB 221, approval by a city or county of new large development projects requires an affirmative written verification of sufficient water supply; which is a "fail safe" mechanism to ensure that collaboration on finding the needed water supplies to serve a new large development occurs before construction begins.

## Methodology

During the years from 2005 to 2010, LADWP has received requests to develop over 40 WSAs. Each WSA performed by LADWP is carefully evaluated within the context of the current adopted UWMP and current conditions, such as restrictions on SWP pumping from the Sacramento-San Joaquin Delta imposed by a Federal court. MWD, from whom the City purchases its SWP and Colorado River water supplies, has also been actively developing plans and making efforts to provide additional water supply reliability for the entire Southern California region. LADWP coordinates closely with MWD to ensure implementation of MWD's water resource development plans and supplemental water reliability report prepared by MWD.

LADWP's UWMP uses a service area-wide method in developing City water demand projections. This methodology does not rely on individual development demands to determine area-wide growth. Rather, the growth in water use for the entire service area was considered in developing long-term water projections for the City to the year 2035. The driving factors for this growth are demographics, weather, and conservation. LADWP used anticipated growth in the various customer class sectors as provided by MWD who reallocated projected demographic data from the Southern California Association of Governments (SCAG) into member agencies' service areas. The data used was based on SCAG's 2008 Regional Transportation Plan Forecast.

As governed by City Charter Sections 673 and 677, LADWP can serve surplus water supplies to areas outside of the City boundaries. There are approximately 4,500 services for customers outside of the City, with a combined annual water use less than 1 percent of all water delivered. Water served outside of the City includes a surcharge to account for the increased MWD purchased water.

The water demand forecast model in the UWMP was developed using LADWP total water use, including the water served

by LADWP for use outside of the City. The service area reliability assessment was performed for three hydrologic conditions: average year, single dry year, and multiple-dry years; and a Shortage Contingency Plan was developed to provide for a sufficient and continuous supply in LADWP's service area. This Shortage Contingency Plan included water provided for use outside of the City.

An important part of the water planning process is for LADWP to work collaboratively with MWD to ensure that anticipated water demands are incorporated into MWD's long-term water resources development plan and water supply allocation plan. The City's allotment of MWD water supplies under MWD's Water Supply Allocation Plan is based on the City's total water demand which includes services to areas outside the City. The ongoing collaboration between LADWP and MWD is critical in ensuring that the City's anticipated water demands are incorporated into the development of MWD's long-term Integrated Resources Plan (IRP). MWD's IRP directs a continuous regional effort to develop regional water resources involving all of MWD's member agencies. Successful implementation of MWD's IRP has resulted in reliable supplemental water supplies for the City from MWD.

In summary, the WSAs are performed to ensure that adequate water supplies would be available to meet the estimated water demands of the proposed developments during normal, single-dry, and multiple-dry water years, as well as existing and planned future uses of the City's water system. LADWP will continue to perform WSAs as part of its long-term water supply planning efforts for its service area.

## WSA Procedure

The CEQA lead agency, such as the City Planning Department or the Community Redevelopment Agency of the City of Los Angeles, evaluates the proposed project against the requirements for a WSA in accordance with the Water Code.

If the proposed project falls within the requirements for a WSA, a formal request is submitted to LADWP to perform a WSA.

In evaluating a proposed project's water demand, LADWP applies the Sewer Generation Factors (published by City of Los Angeles Bureau of Sanitation) to the development's project description for calculating indoor water use. Outdoor landscape water demand is calculated by using computer software which takes into account various factors such as landscape area square footage, location, and plant types. Historical billing records are used to establish existing baseline water demand on the property.

LADWP also encourages all projects to implement additional water conservation measures above and beyond the current water conservation ordinance requirements. As an example, if the proposed development is near an existing or future recycled water pipeline system, commitment to use recycled water for irrigation, toilet flushing and cooling towers is highly recommended as part of the additional conservation measures for the proposed development.

The net increase/decrease in water demand, which is the projected additional water demand of the development, is calculated by subtracting the existing baseline water demand and water saving amount from the total proposed water demand. If the land use of the proposed development is consistent with the City's General Plan, the projected water demand of the development is considered to be accounted for in the most recently adopted UWMP. The City incorporates the projected demographic data from the SCAG in its General Plan. MWD utilizes a land use based planning tool that allocates SCAG's projected demographic data into water service areas for their member agencies, which was adopted for water demand projection in the UWMP.

If the proposed land use is not consistent with the City's General Plan, the WSA will further evaluate if the projected supplies from the UWMP are able to accommodate

the proposed project's water demand, which may include other resource options to offset the projected water demand.

All WSAs are subject to approval by the Board of Water and Power Commissioners. Upon approval, the CEQA lead agency is responsible for enforcing the requirements of the WSA as part of the approval for the project.





## Chapter Twelve

# Climate Change

### 12.0 Overview

---

LADWP is considering the impacts of climate change on its water resources as an integral part of its long-term water supply planning. Climate change is a global-scale concern, but is particularly important in the western United States where potential impacts on water supplies can be significant for water agencies. Climate change can impact surface supplies from the Los Angeles Aqueduct (LAA), imported supplies from Metropolitan Water District (MWD), and local demands. As part of this impact analysis, LADWP completed a study to analyze the operational and water supply impacts of potential shifts in the timing and quantity of runoff along the LAA system due to climate change in the 21st Century. Such potential shifts may require LADWP to modify both the management of local water resources and LAA supplies. Projected changes in climate are expected to alter hydrologic patterns in the LAA's eastern Sierra Nevada Watershed through changes in precipitation, snowmelt, relative ratios of rain and snow, winter storm patterns, and evapotranspiration.

To understand some of the key issues surrounding climate change impacts, it is important to put it into the context of LADWP's water supplies. California lies within multiple climate zones. Therefore, each region will experience unique impacts due to climate change. Because LADWP relies on both local and imported water sources, it is necessary to consider the potential impacts climate change could have on the local watershed as well as the western and eastern Sierra Nevada watersheds. The western Sierra Nevada is where a portion of MWD's imported water originates and the eastern Sierra

Nevada is where LAA supplies originate. It is also necessary to consider impact in the Colorado River Basin where Colorado River Aqueduct supplies originate.

Generally speaking, any water supplies that are dependent on natural hydrology are vulnerable to climate change, especially if the water source originates from mountain snowpack. For LADWP, the most vulnerable water sources subject to climate change impacts are imported water supplies from MWD and the LAA. However, local sources can expect to see some changes in the future as well. In addition to water supply impacts, changes in local temperature and precipitation are expected to alter water demand patterns. However, there is still general uncertainty within the scientific community regarding the potential impacts of climate change within the City of Los Angeles. LADWP will continue to stay abreast of developments in climate change to better understand its potential implications for the City's local and imported water supplies and in-city demands.

### 12.1 Potential Impacts of Climate Change on Water Service Reliability

---

Scientists predict future climate change scenarios using highly complex computer global climate models (GCMs) to simulate climate systems. Although most of the scientific community agrees that climate change is occurring and, as a result, mean temperatures for the planet will increase, the specific degree of this temperature increase cannot be accurately predicted. Predictions of changes in precipitation

are even more speculative, with some scenarios showing precipitation increasing in the future and others showing the opposite.

It is important to acknowledge that the predictions of the GCMs lack the desired precision due to the presence of uncertainties inherent in the analyses. The uncertainty relating to future emissions of greenhouse gases (GHG) and the chaotic nature of the climate system leads to uncertainty in regard to the response of the global climate system to increases in GHG. In addition, the science of climate change still lacks a complete understanding of regional manifestations resulting from global changes, thus restraining the projecting ability of these models. However, these model's projections are consistent with the state of science today, and they help predict the manner in which hydrologic variables are likely to respond to a range of possible future climate conditions, and thus they provide invaluable insight for water managers in their decisions pertaining to water supply reliability.

The regional areas of interest in assessing climate change impacts to LADWP include the local service area and sources of origination for imported water supplies in northern California, eastern Sierra Nevada Mountains, and the Colorado River Basin. Data regarding climate change impacts for the various regions of interest is provided in this section.

### 12.1.1 Local Impacts

Most scientific experts believe that because of the uncertainty involved with each model, several models should be used to test the potential impact of climate change. To downsize the global coarse-scale climate projections to a regional level incorporating local weather and topography, the GCMs are "downscaled". For the City of Los Angeles, future

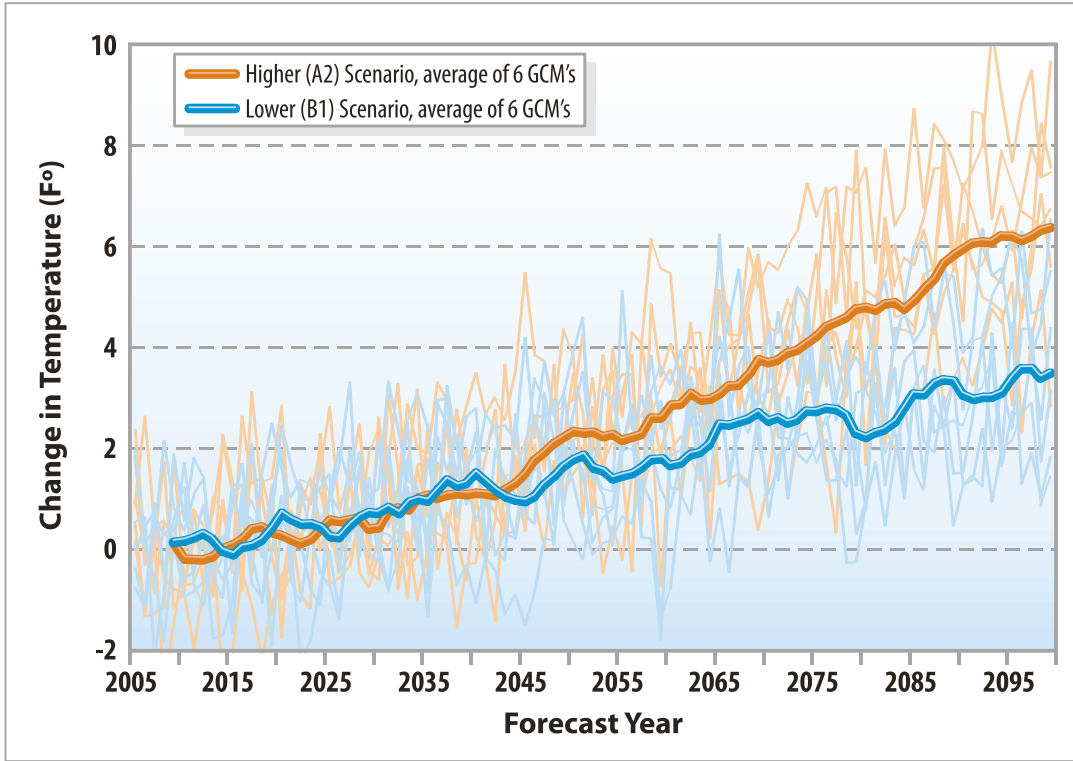
projections of precipitation and temperature were obtained for six GCMs under two GHG emission scenarios (A2 - higher and B1 - lower) . Exhibits 12A and 12B plot the changes in projected average annual mean temperature and precipitation, respectively for the model scenarios. The bold line represents the running average of all six models for each emission scenario. These six models were also used in preparation of the California Energy Commission – Public Interest Energy Research Program's study entitled *Climate Change Scenarios and Sea Level Rise Estimates for the 2008 California Climate Change Scenarios Assessment*, which investigated possible future climate changes throughout California.

Local climate changes within the vicinity of the LADWP service area are expected to include:

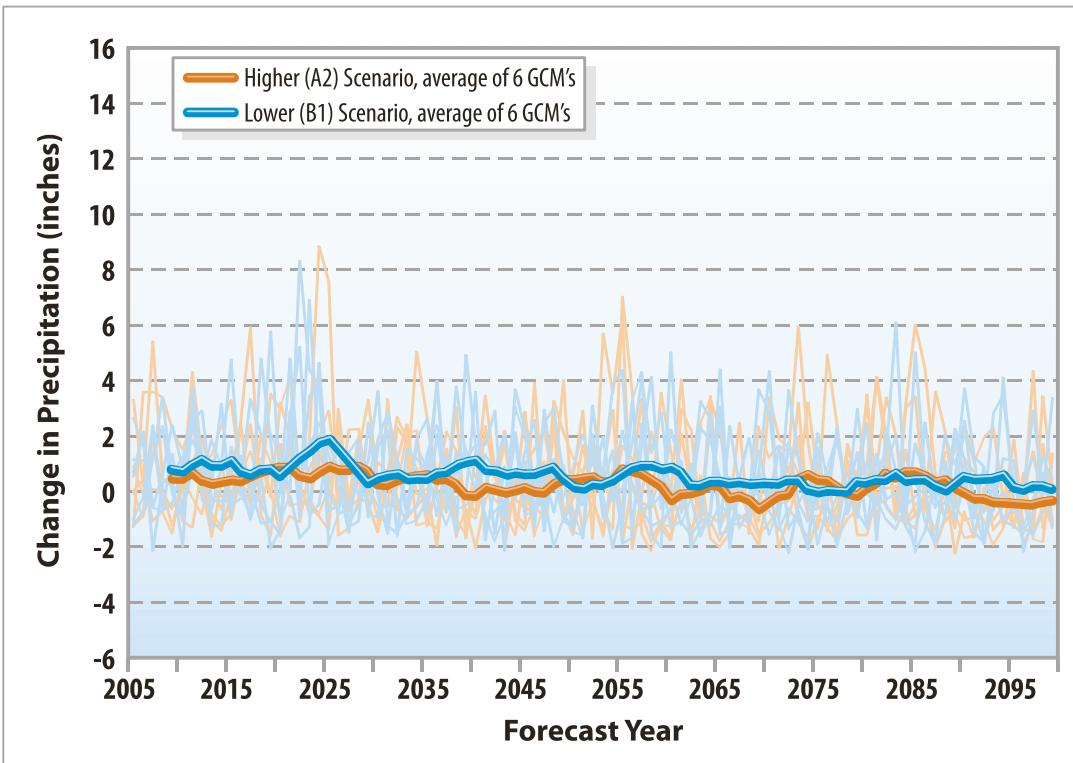
- An increase in average temperatures that will be more pronounced in the summer than in the winter with annual mean temperatures in year 2100 increasing greater than 3°F when lower GHG emission scenarios are used and may exceed 6°F when high higher emissions scenarios are used dependent upon the GCM employed.
- An increase in extreme temperatures.
- An increase in heat waves and dry periods that will extend for a longer duration.
- A slight decrease in precipitation coupled with increases in temperature will result in greater evapotranspiration.
- An increase in short-duration/high volume intense storm events during the winter.

The impact of these climate effects will likely be increased water demands for irrigation and cooling purposes earlier in the year and for longer periods coupled with decreased local surface runoff available to recharge groundwater basins. Other impacts might include an increase

**Exhibit 12A**  
**Climate Change Impacts to Local Temperatures for Los Angeles**



**Exhibit 12B**  
**Climate Change Impacts to Local Precipitation for Los Angeles**



Dan Cayan and Mary Tyree (University of California, San Diego, Scripps Institute of Oceanography) provided downscaled data for the City of Los Angeles under two emissions scenarios from six climate models: CNRM CM3, GFDL CM2.1, Miroc3.2 (medium resolution), MPI ECHAM5, NCAR CCSM3, NCAR PCM1.

Note: These scenarios do not bracket the highest and lowest emission futures possible, but represent a status quo approach (A2) and a pro-active mitigation (B1) approach to reduce carbon emissions

in fire events impacting water quality and sedimentation, a decrease in groundwater recharge due to lower soil moisture, and sea level rise increasing seawater intrusion into coastal groundwater basins.

### 12.1.2 Los Angeles Aqueduct Impacts

The LAA is one of the major imported water sources delivering a reliable water supply to the City of Los Angeles. The LAA originates approximately 340 miles away gathering snowmelt runoff in the eastern Sierra Nevada; hence the LAA is subject to hydrologic variability which will be impacted by climate change. Since the majority of precipitation occurs during winter in the eastern Sierra Nevada watershed, water is stored in natural reservoirs in the form of snowpack, and is gradually released into streams that feed into the LAA during spring and summer. More detailed information regarding the LAA is presented in Chapter 5, Los Angeles Aqueduct Systems.

Higher concentrations of GHG in the atmosphere are often indications of pending climate change. These changes

threaten the hydrologic stability of the eastern Sierra Nevada watershed through alterations in precipitation, snowmelt, relative ratios of rain and snow, winter storm patterns, and evapotranspiration, all of which have major potential impacts on the LAA water supply and deliveries.

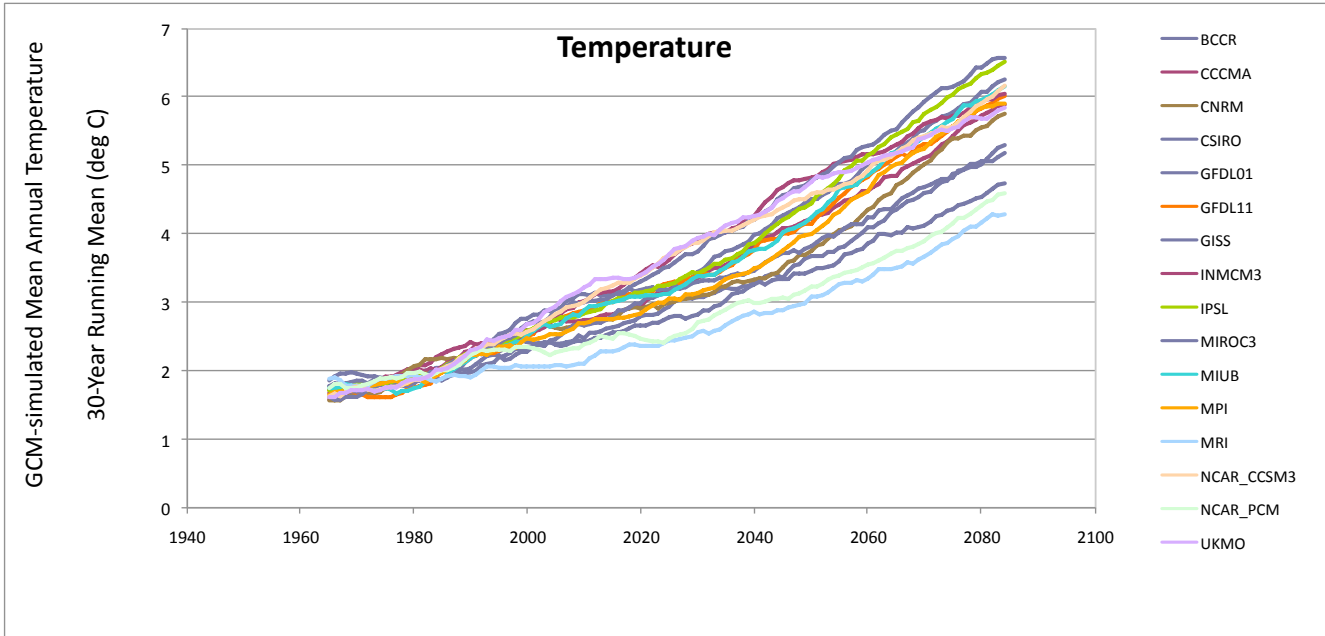
To address the possible challenges posed by climate change on the LAA, LADWP completed a climate change study. The study evaluated the potential impacts of climate change on the eastern Sierra Nevada watershed and on LAA water supply and deliveries. It also investigated opportunities to improve the LAA system as a result of potential impacts in the 21st century. In this study, future climate conditions are predicted using a set of sixteen GCMs and two GHG emission scenarios.

The impacts of these climate change scenarios and the associated hydrology on the LAA's eastern Sierra Watershed includes an analysis of historical temperature, precipitation, water quality, and runoff records. Hydrologic modeling was performed to estimate runoff changes from current conditions and to determine the impact of these runoff changes on the performance of the LAA infrastructure with regards to storage and conveyance to Los Angeles. As part of the evaluation of potential adaptation measures if existing infrastructure proves to be inadequate, recommendations were provided on how to modify the LAA infrastructure and operations to accommodate these impacts.

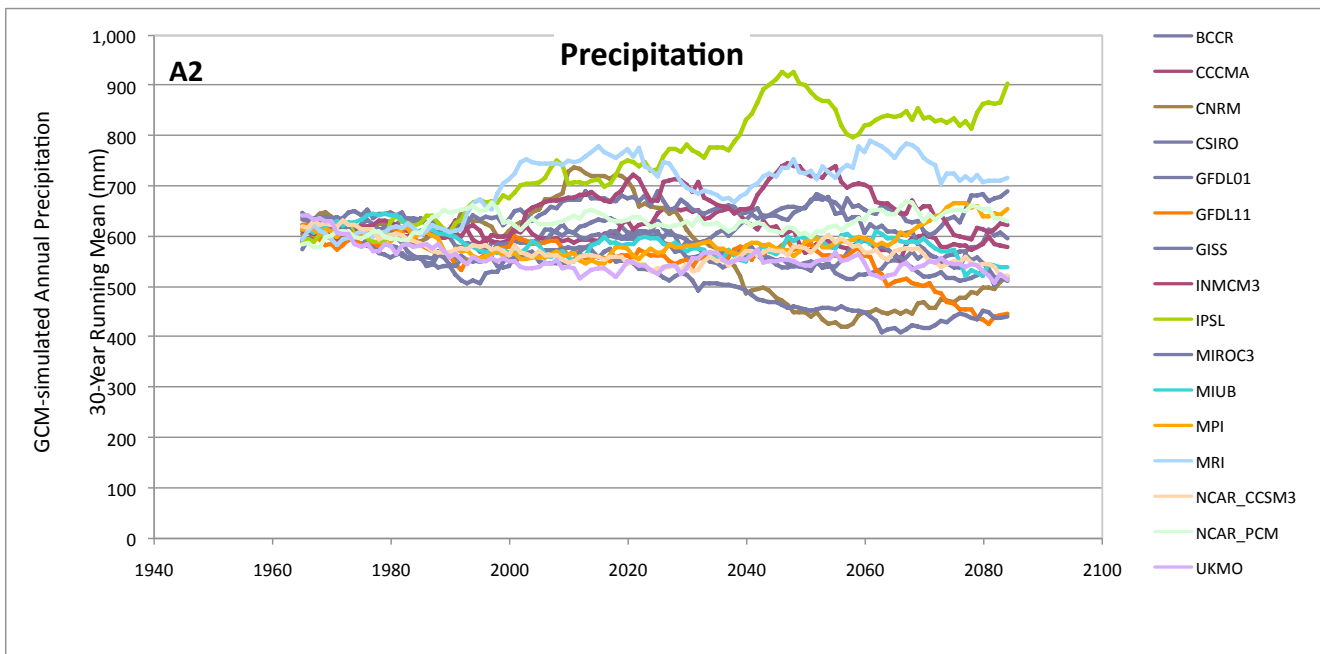
Results of the study show steady temperature increases throughout the 21st century and are consistent with other prior studies performed in the scientific community. Exhibit 12C displays the time series of 30-year running means of the projected temperature for the A2 GHG emission scenario (higher GHG emissions) averaged over the simulation area for each of the sixteen GCM models. All GCMs project temperature increases throughout the 21st century.



**Exhibit 12C**  
**30-Year Time Series Projected Temperature Means for Eastern Sierra Nevada Watershed**



**Exhibit 12D**  
**30-Year Time Series Projected Precipitation Means for Eastern Sierra Nevada Watershed**



On the other hand, forecasts for precipitation differ greatly between the GCMs. Some GCMs projected increases, but the majority of the model outputs projected decreases in precipitation over the study period. Exhibit 12D displays the time series of 30-year running means of the projected precipitation using the A2 GHG emission scenario (higher GHG

emissions) averaged over the simulation area for each of the sixteen GCM models.

Temperature is the main climate variable that is projected to rise significantly in the coming years and decades. The rise in temperature directly affects several variables including:

- Whether precipitation falls as snow or rain.
- The ground-level temperature that determines the timing and rate of snowmelt.
- The temperature profile in the canopy that determines the rate of evapotranspiration.

Results have shown that future predictions for the early-21st century suggest a warming trend of 0.9 to 2.7°F and almost no change in average precipitation. Mid-21st century projections suggest a warming trend of 3.6 to 5.4°F and a small average decrease in precipitation, approximately 5 percent. This warming trend is expected to increase by the end of the 21st century, as the results indicate further warming of 4.5 to 8.1 °F and a decrease in precipitation of approximately 10 percent. In addition, results indicate an increase in the frequency and length of droughts in the end-of-century period.

Projected changes in temperature (warmer winters) will change precipitation patterns from snowfall to rainfall with a larger percentage coming as rain than historically encountered. Consequently, peak Snow Water Equivalent (SWE) and runoff are projected to undergo a shift in timing to earlier dates.

With a long term-shift in mean temperature of 3.6°F, the snowpack of the eastern Sierras, at elevations of up to about 9,800 feet, is susceptible to earlier melt and less accumulation. On average, mean temperature rises are in

the range of 3.6 to 10.8 °F resulting in about a 17 to 50 percent loss in snowpack storage, respectively. This vulnerability shows up in average to warm winters and will directly affect stream levels and stream discharge. This raises potential operational concerns for LADWP regarding adequate storage, especially the capacity of the LAA system to store the earlier runoff in surface reservoirs.

The projected temperature and precipitation dataset form the basis of the hydrologic model projections for runoff, SWE, and rain-to-snow ratio. To compare the future projections of these variables, the trends that dominated the second half of the 20th century are considered baselines for future trends. The baseline values for runoff, SWE, and rain-to-snow ratio are 0.6 million acre-feet (MAF), 15 inches, and 0.2, respectively. By early 21st century (2010 – 2039), results illustrate runoff is projected to undergo increases and decreases averaging between 0.5 to 0.85 MAF, the SWE is projected to undergo decreases and increases ranging between 10.6 to 19.0 inches, and the rain-to-snow ratio is projected to increase between 0.24 to 0.33. By mid-century (2040 – 2069), the same trends are expected to dominate, with runoff ranging between 0.34 to 0.9 MAF, the SWE ranging between 7.0 to 19.7 inches, and the rain-to-snow ratio increasing between 0.25 to 0.43. These trends are expected to govern until the end-of-century (2070 -2099) with runoff ranging between 0.35 to 1.1 MAF, the SWE ranging between 5.0 to 16.0 inches, and the rain-to-snow ratio increasing between 0.28 to 0.54. Exhibit 12E summarizes the projections for runoff, SWE, and rain-to-snow ratio for the 21st century.

**Exhibit 12E**  
**Projected Runoff, Snow-Water Equivalent, and Rain-to-Snow Ratio for Eastern Sierra Nevada Watershed**

	Runoff (MAF)	April 1 SWE (Inches)	Rain/Snow Ratio
<b>Baseline (Second Half of 20<sup>th</sup> Century)</b>	<b>0.6</b>	<b>15.0</b>	<b>0.2</b>
<b>Early 21st-century (2010-2039)</b>	0.5 - 0.85	10.6 - 19.0	0.24 - 0.33
<b>Mid-century (2040-2069)</b>	0.34 - 0.9	7.0 - 19.7	0.25 - 0.43
<b>End-of-century (2070-2099)</b>	0.35 - 1.1	5.0 - 16.0	0.28 - 0.54

**Exhibit 12F**  
**Projected Rain to Precipitation Ratio Based on Projected Precipitation and Temperature**

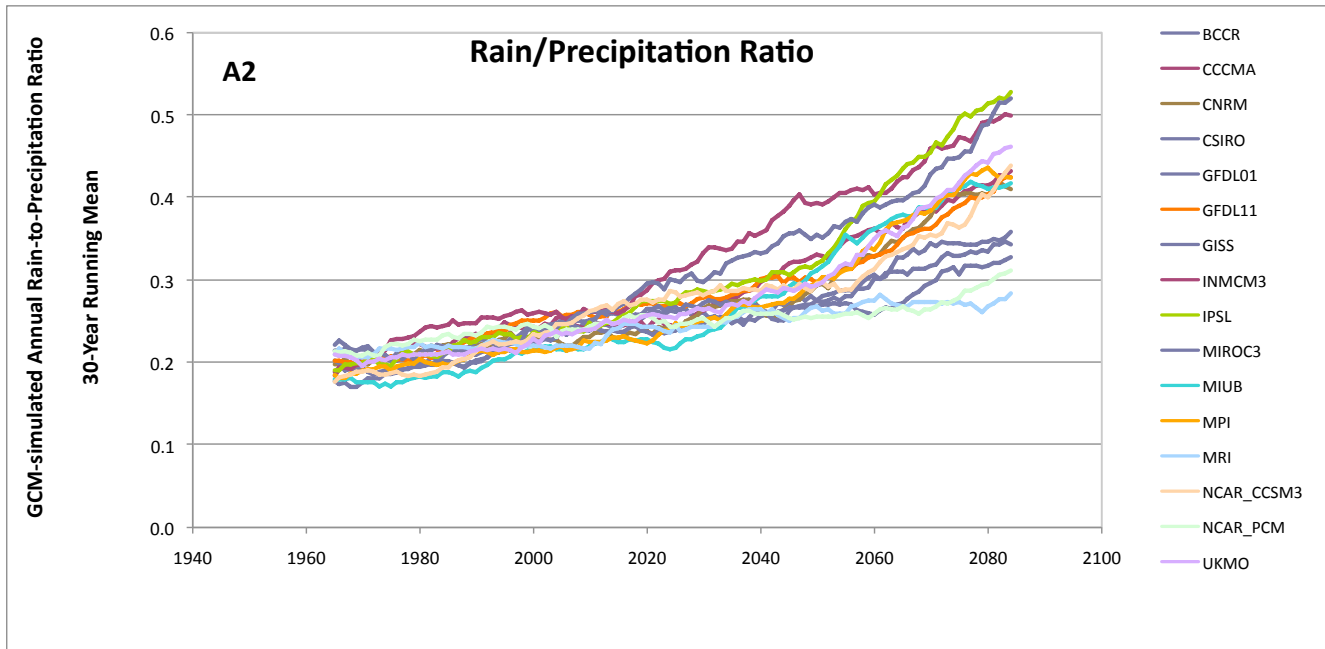


Exhibit 12F displays the rain-to-snow ratio based on the projected precipitation and temperature for the 16 GCMs. The rain-to-snow ratio is projected to increase throughout the 21st century, ranging between 0.24 to 0.33 by early 21st century, between 0.25 to 0.43 by mid-century, and between 0.28 to 0.54 by the end-of-century.

The increase of rain-to-snow ratio indicates the shift from snowfall to rainfall, specifically at low to moderate elevations, where the temperature tends to be warmer. This shift indicates more precipitation as liquid, and in turn, leads to loss of the snowpack. The snowpack is critical in providing seasonal storage by releasing winter precipitation in the spring and summer. The spring and summer snowmelt provides for increased soil moisture and stream flows needed to sustain both ecosystems and human populations.

Although the results above are quantitative in nature, it is important to account for the uncertainties inherent in these predictions. The results of this study will help guide the water managers in planning and developing water supply and infrastructure to ensure the reliability and sustainability of adequate water supply and delivery well into the future.

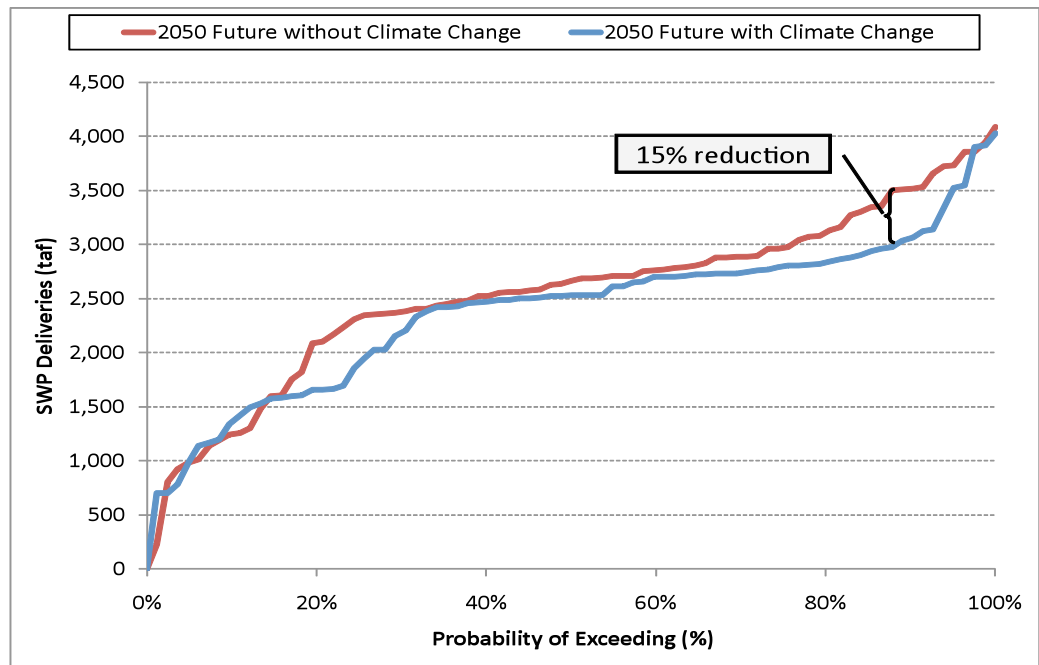
**12.1.3 State Water Project Impacts**

To date, most studies on climate change impacts to California’s water supply have been conducted for the Northern California region. In August 2010, DWR released the 2009 State Water Project Delivery Reliability Report, which specifically analyzes changes in volume of water available under various climate change scenarios. DWR projected that SWP deliveries could be reduced by as much as 15 percent in some cases as illustrated in Exhibit 12G.

To incorporate climate change into its reliability reports, DWR reviewed 6 GCMs for year 2050 projections using lower emission and higher emission scenarios contained in *Using Future Climate Projections to Support Water Resources Decision Making in California* prepared in April 2009 by DWR. DWR selected the model most representing median effects on the SWP, which included a higher GHG scenario.

Climate change has the potential to disrupt SWP source supplies, impact conveyance, and alter storage levels in reservoir carryover storage. Annual Bay-Delta exports to areas south of the Bay-

## Exhibit 12G Climate Change Impacts on SWP Delivery



Delta are expected to decline 7 percent for the lower GHG emissions scenario and 10 percent for the higher emissions scenario. However, it should be noted that for the six GCMs under the lower and higher emission scenarios the range varies from a 2 percent increase to a 19 percent decrease illustrating the variability in the various GCMs.

By 2050, median reservoir carryover storage is projected to decline by 15 percent for the lower emissions scenario and 19 percent for the higher emissions scenario thereby reducing operational options if water shortages were to occur. Furthermore, by 2050 it is projected a water shortage worse than the 1977 drought could potentially occur in 1 out of every 6 to 8 years requiring acquisition of other supplies, reductions in water demands, or a combination thereof. An additional 575 to 850 TAF would be needed to maintain minimum SWP operation requirements and meet regulatory requirements. The main supply reservoirs on the SWP must maintain minimum water levels to allow water to pass through their lower release outlets in

the dams. However, the April 2009 report does not consider the SWP vulnerable to a system interruption such as this under current conditions.

The primary effects of climate change on the SWP identified in the 2009 Reliability Report include, among others:

- More precipitation will fall as rain than snow.
- Reductions in Sierra snowpack.
- Sea level rise threatening the Bay-Delta levee system.
- Increased salinity in the Bay-Delta due to sea level rise requiring releases of freshwater from upstream reservoirs to maintain water quality standards.
- Shifted timing of snowmelt runoff into streams – spring runoff comes earlier resulting in increased winter flows and decreased spring flows.
- Increased flood events.



The most severe climate impacts in California are expected to occur in the Sierra watershed, where the SWP supply originates. Therefore, imported SWP water is extremely vulnerable to climate change.

### 12.1.4 Colorado River Aqueduct Impacts

---

Per MWD Board report titled “Report on Sustainable Water Deliveries from the Colorado River Factoring in Climate Change” and dated August 28, 2009, there have been numerous studies attempting to predict the impacts of climate change on the Colorado River. Several of the studies concluded that the Colorado River flow could be reduced by climate change by anywhere from 5 percent to 45 percent by the year 2050. The range of potential impacts can be very large thereby making it very challenging for water agencies to develop water management plans to address climate change impacts on the Colorado River Basin. Factors that have been identified and may contribute to this difficulty in narrowing the range of potential impacts of climate change on the Colorado River Basin include the following:

- The topography of the Colorado River Basin is difficult to model. Hydrologists have found that 80 percent of the flow of the Colorado River Basin is dependent upon the precipitation that falls in about 20 percent of the highest portions of the Upper Basin, in the mountains above 8,000 feet. Most global climate models are not precise enough to take into account the highly variable nature of the Colorado River Basin and can provide misleading results.
- There is a lack of data for much of the Colorado River Basin. While the runoff in the Colorado River Basin is well known, many other important

watershed datasets are not readily available, including vegetation and soil type, soil moisture, wind, and solar radiation. These factors are important to predict future Colorado River flow and lack of data in remote areas presents uncertainty.

- Differences in modeling methods. Different modeling methods predict different runoff impacts from temperature increases due to GHG emissions. Each study used a different technique ranging from (1) using output from global climate models, to (2) statistical relationships relating temperature and precipitation to stream flow, to (3) a sophisticated model simulating soil moisture, snow accumulation and melt and evapotranspiration. Additionally, there is uncertainty in the level of GHG in the future based on the existing scientific literature.

In response to the potential impacts, MWD has worked to reduce demands by implementing water use efficiency programs in their service area including aggressive water conservation programs, and by increasing Colorado River supplies through programs such as agricultural to urban transfers.

### 12.2 Water and Energy Nexus

---

It is widely believed in the scientific community that the increase in concentrations of GHG in the atmosphere is a major contributing factor to climate change. As such, California is leading the way with laws that require reductions in GHG emissions and requirements to incorporate climate change impacts into long range water resource planning.

Carbon dioxide emissions into the atmosphere and the emissions of other GHGs are often associated with the burning of fossil fuels like crude oil and



## 12.2.1 State Water Project Supplies

---

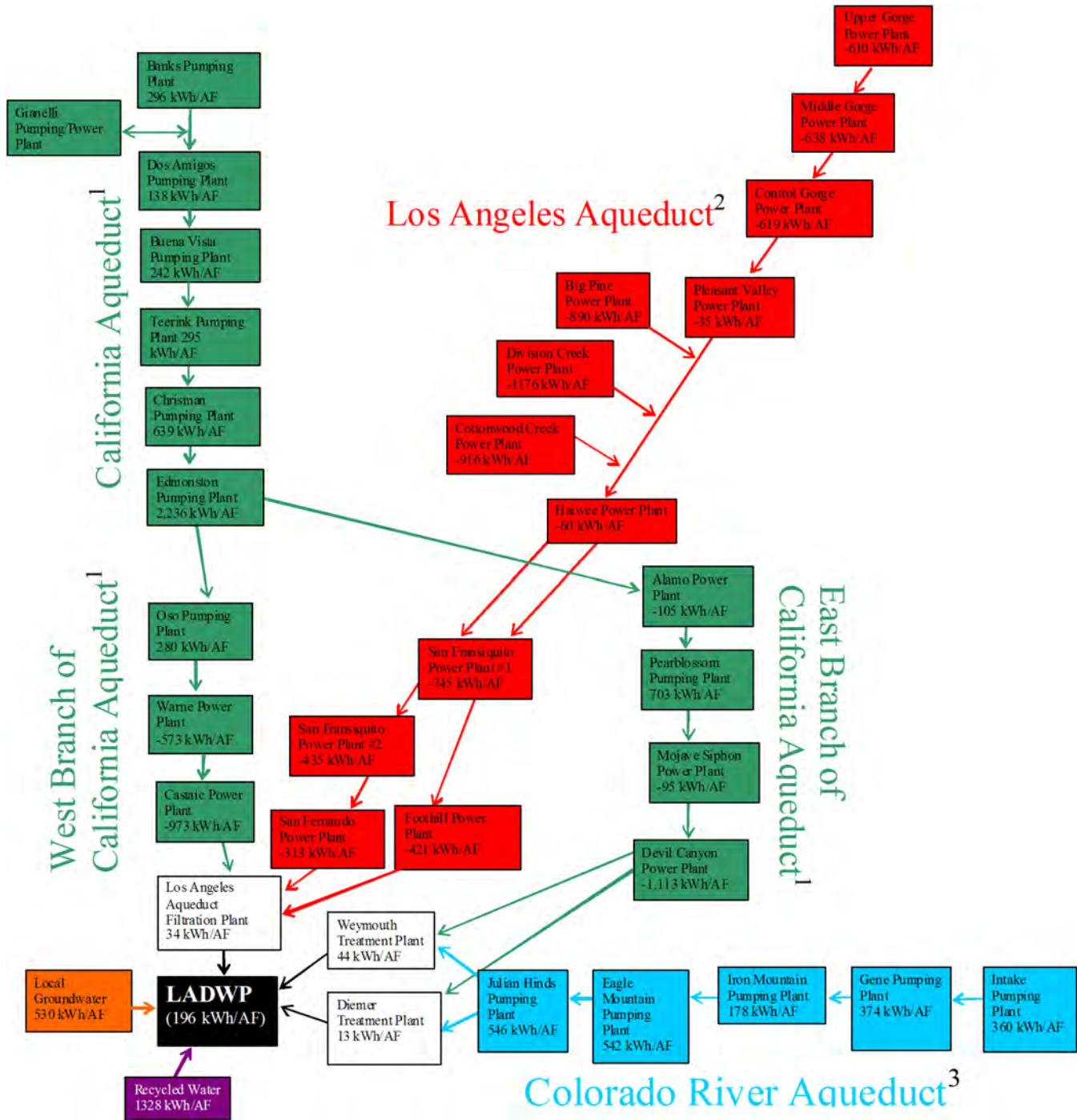
coal in the generation of energy. As a significant amount of energy is required for the movement of water over long distances and elevations, a link was subsequently realized between water supply conveyance and corresponding GHG emissions through its energy consumption. An assessment of the GHG emissions, sometimes also known as carbon footprint expressed in units of tons CO<sub>2</sub>, could be estimated for water. Once the size of a carbon footprint is known, a strategy can be developed to better manage and reduce its impact on climate change.

LADWP has taken the initiative to study the nexus between water and energy consumption and to evaluate the associated carbon footprint of its water system. The most energy intensive source of water for LADWP is water purchased from MWD, which imports SWP supplies via the California Aqueduct and Colorado River supplies via the CRA. LADWP also imports water via the LAA, which is a net producer of energy. Local sources of water for LADWP include groundwater and recycled water. Exhibit 12H outlines the sources of LADWP's water supply as well as the energy profiles of each facility that provides water to LADWP. For those sources of water operated by LADWP, the energy intensity has been computed by dividing the total energy consumed/generated by the total water produced or processed by that source.

Water supplied to Los Angeles via the SWP originates from Northern California and the Bay-Delta and is conveyed along the 444-mile long California Aqueduct to Southern California. Six pump stations are required to lift the water to the point at which the California Aqueduct splits into two branches. At the zenith of the California Aqueduct in the Tehachapi Mountains, approximately 3,846 kilowatt hours per acre foot (kWh/AF) is required to lift the water from the start of the aqueduct. After the water passes through Edmonston Pumping Plant, the California Aqueduct separates into two branches, the West Branch and the East Branch. Along the West Branch, the water is lifted once more at the Oso Pumping Plant and then energy is recovered through hydro-electric generation at the Warner and Castaic Power Plants. By the time the West Branch reaches its terminus at Lake Castaic, the net energy consumed in transporting the water from the Bay-Delta is approximately 2,580 kWh/AF. Water supplied through the West Branch is provided to the San Fernando Valley, Western Los Angeles, and Central Los Angeles communities.

Along the East Branch, the water generates power at the Alamo Power Plant, is lifted once more at Pearblossom Pumping Plant, and then used for generation at Mojave Siphon and Devil Canyon Power Plants. At the East Branch terminus at Lake Perris, approximately 3,236 kWh/AF of energy has been expended in the transport. Water conveyed through the East Branch is provided to the Eastern Los Angeles and Harbor communities. The water supplied from the SWP is the most energy intensive source of water available to LADWP.

**Exhibit 12H**  
**Energy Intensity of LADWP's Water Sources**



1. Source: Methodology for Analysis of the Energy Intensity of California's Water Systems. p. 27.

2. Generation on the Los Angeles Aqueduct is not considered in LADWP's total energy intensity.

3. Energy intensities for the Colorado River Aqueduct pumping stations were derived by multiplying the total energy intensity for the aqueduct by the proportion of load for each individual pumping station in relation to the total load for all five pump stations.

4. Positive numbers indicate power consumption due to pumping and negative numbers indicate power generation.

### 12.2.2 Colorado River Aqueduct Supplies

---

Water supplied from the Colorado River is imported via the 242 mile CRA operated by MWD. From the start of the aqueduct at Lake Havasu to its terminus at Lake Mathews, the water is lifted approximately 1,617 feet. Five pumping stations along the aqueduct lift the water to MWD's service area requiring approximately 2,000 kWh/AF. CRA water is the second most energy intensive water source for Los Angeles and is supplied to the eastern Los Angeles and Harbor communities. Together SWP water and CRA water comprise the total imported provided by MWD to LADWP. MWD imported water is the most expensive water source for LADWP in terms of both cost and energy.

attributed to the fact that not all water wheeled through the aqueduct is used to generate power and the fact that a portion of the water is introduced into the aqueduct system at a point downstream of several of the power plants. For the purposes of determining LADWP's total energy intensity, the energy intensity of the LAA is considered to be zero since the power generated does not directly offset the energy required for other sources of water. However, in terms of supply the LAA is able to offset the more energy intensive sources of water, consequently reducing the overall energy intensity of LADWP's water supplies. As LAA flows to Los Angeles are decreased due to environmental enhancement efforts in the Owens Valley and Mono Basin, LADWP is forced to increasingly rely on energy intensive water purchased from MWD. LAA water currently supplies approximately 37 percent of the demand for Los Angeles.

### 12.2.3 Los Angeles Aqueduct Supplies

---

The LAA provides water from the Eastern Sierra watershed and is entirely gravity fed. As a result, no energy is required to import LAA water, making it the most desirable source of water in terms of energy intensity. There are twelve power generation facilities along the aqueduct system. On average, the LAA generates approximately 6,848 kWh/AF from water directly used to generate power. This number was determined using the same methodology as was used to determine the energy intensity for the two branches of the SWP. The individual energy intensities for each individual generating facility were summed up to arrive at the total energy intensity for the water used to generate power. However, when considered from the perspective of total amount of water delivered to Los Angeles via the LAA, the energy generated along the aqueduct is approximately 2,456 kWh/AF. The variance between the numbers can be

### 12.2.4 Local Groundwater Supplies

---

Groundwater currently accounts for approximately 11 percent of LADWP's water supply and has an average energy intensity of approximately 530 kWh/AF. As LADWP continues with its cleanup of the contaminated water in the San Fernando Basin, groundwater will play an increasingly important role in Los Angeles' water supply. Although there is potential for a future increase in the energy required to produce groundwater due to the introduction of new treatment technologies, groundwater is expected to remain a low energy source of water when compared to imported supplies purchased from MWD. Increasing groundwater production will allow LADWP to offset the energy intensive MWD sources and reduce its overall energy intensity.

## 12.2.5 Recycled Water Supplies

---

Recycled water is currently the smallest component of LADWP's water supply portfolio, with municipal and industrial uses accounting for less than 1 percent of total supplies. Currently, LADWP directly receives recycled water from three wastewater treatment plants operated by Bureau of Sanitation (BOS), two of which provide recycled water treated to a tertiary level: Los Angeles Glendale (LAG) Treatment Plant and Donald C. Tillman (DCT) Treatment Plant. The Terminal Island Treatment Plant (TITP) performs advanced treatment of recycled water in addition to tertiary treatment. LADWP also directly receives a small portion of recycled water from the West Basin Municipal Water District (WBMWD), which provides additional treatment of wastewater from the Hyperion Treatment Plant (HTP) in El Segundo. Since all water at the plants directly supplying recycled water to LADWP is treated to at least a tertiary level regardless of disposal or reuse, the energy cost to treat the water to this level is considered a sunk cost because the water would be treated whether it offsets potable use or not. The advanced treatment process at the TITP is beyond the requirements for discharge and is therefore not considered a sunk cost. The incremental energy required to treat water from tertiary levels to advanced treatment levels at TITP requires approximately 2,200 kWh/AF. Since the treatment energy at the other two plants is not considered additional energy, only the pumping energy is included in the overall LADWP recycled water energy intensity. For the LAG, the pumping requires approximately 690 kWh/AF, and for the DCT the pumping requires approximately 450 kWh/AF. A weighted average of these values gives recycled water an energy intensity of approximately 1,139 kWh/AF. In the future, this number will likely change as the recycled water infrastructure is expanded. In addition to the municipal and industrial recycled water that is considered in LADWP's total

supplies, the plants produce significant additional volumes of recycled water that is beneficially used. Beneficial uses include the seawater barrier for the Dominquez Gap using recycled water from TITP and the Japanese Garden and Los Angeles River from DCT.

## 12.2.6 Treatment Energy

---

Another factor in determining the energy intensity of LADWP's water is the energy required to treat water. All LAA water and nearly all West Branch SWP water purchased by LADWP are treated at the Los Angeles Aqueduct Filtration Plant (LAAFP). For the LAAFP, the average treatment energy intensity is approximately 34 kWh/AF. The East Branch SWP water and the CRA water are primarily treated at the Weymouth Treatment Plant in the San Gabriel Valley and the Diemer Treatment Plant in Orange County. Both of these treatment plants are operated by MWD. The average energy intensity for Weymouth Treatment Plant is approximately 42 kWh/AF and supplies water to the East Los Angeles Community. The average energy intensity for the Diemer Treatment Plant is 13 kWh/AF and supplies water to the Harbor Community. The mix of SWP East Branch water and CRA water that flows through these two treatment plants varies depending on the regional hydrology of the two sources, but on average approximately 55 percent SWP East Branch water and 45 percent CRA water flows through each of these MWD treatment plants.

The proportion that each of the above mentioned sources contributes to the LADWP's total supplies is displayed in Exhibit 12I. Of note is the relationship that the volume of LAA flow has to the amount of SWP water imported into the system. In this case, the energy free LAA water is replaced by the energy intensive SWP water resulting in an increase in the overall energy intensity.

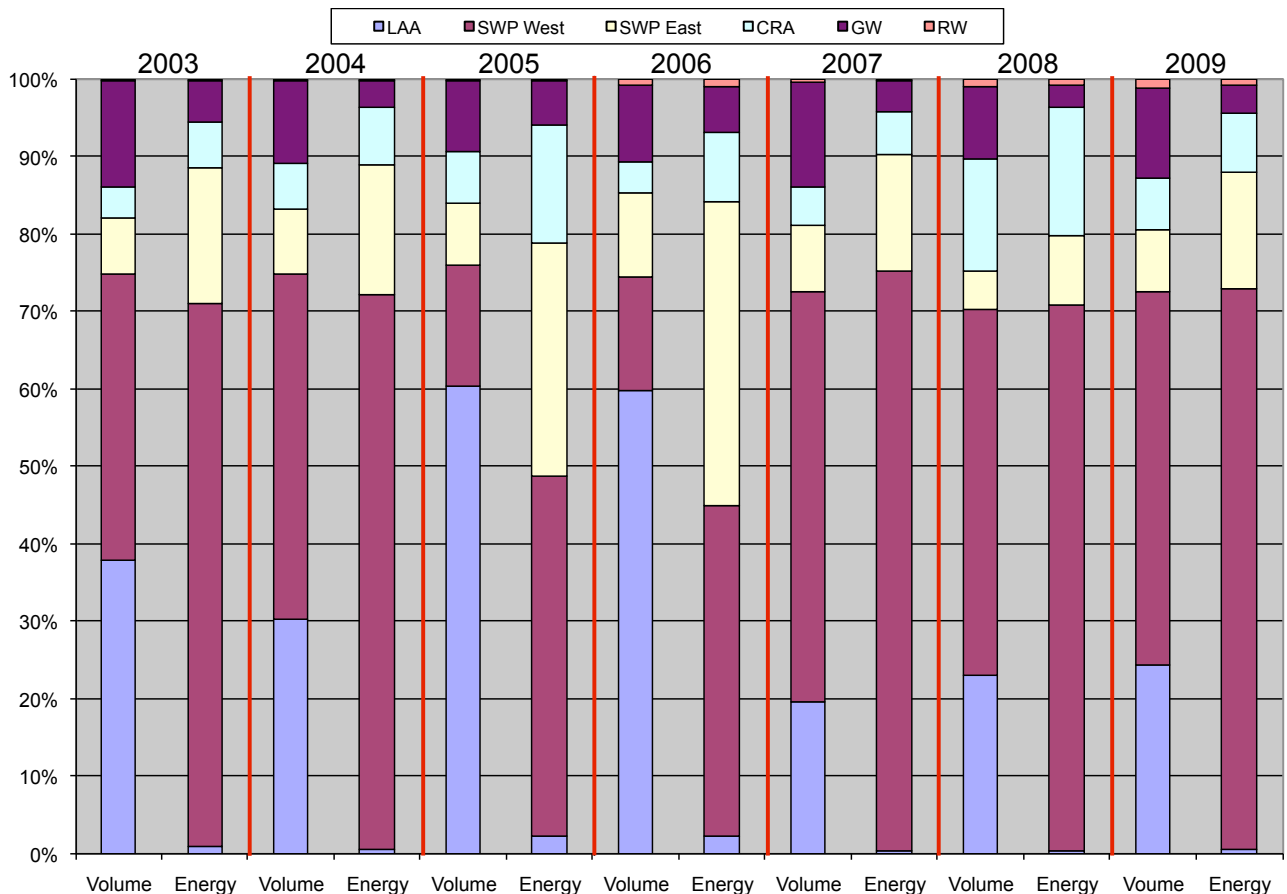
## 12.2.7 Distribution Energy

LADWP benefits from the topography of its service area in that much of the hydraulic head required for water distribution is provided by gravity. With the major sources of LADWP's water entering the service area at higher elevation than the rest of the City, the energy required for distribution is lower than much of the region. The average energy intensity for LADWP water distribution is approximately 196 kWh/AF.

individual sources between 2003 and 2009. Exhibit 12K shows a graphical representation of the total energy intensity for LADWP for the same time period. An important detail is the influence that LAA water has on the total energy intensity for a given year. For those years with large volumes of LAA water, such as 2005 and 2006, the total energy intensity was correspondingly low. Alternatively, those years with low volumes of LAA water have high total energy intensity as a result of the energy requirements for imported MWD supplies

Exhibit 12J shows the sum of the energy intensities for LADWP from each of the

**Exhibit 12I**  
**Proportion of Volume Delivered and Total Energy Intensity (Inclusive of Treatment)**



**Exhibit 12J**  
**LADWP Energy Intensity 2003-2009**

		2003	2004	2005	2006	2007	2008	2009
Los Angeles Aqueduct (0 kWh/AF)	Volume (AF)	251,942	202,547	368,839	378,922	129,400	147,365	137,084
	Treatment Energy Intensity (kWh/AF) <sup>1</sup>	34	34	34	34	34	34	34
	Weighted Energy Intensity (kWh/AF)	13	10	20	20	7	8	8
State Water Project West Branch (2580 kWh/AF)	Volume (AF)	244,218	296,722	95,538	93,694	350,302	304,221	270,653
	Treatment Energy Intensity (kWh/AF) <sup>1</sup>	34	34	34	34	34	34	34
	Weighted Energy Intensity (kWh/AF)	961	1,161	408	386	1,384	1,237	1,258
State Water Project East Branch <sup>3</sup> (3236 kWh/AF)	Volume (AF)	48,980	56,301	49,526	68,796	56,357	31,016	45,246
	Treatment Energy Intensity (kWh/AF) <sup>2</sup>	27	27	27	27	27	27	27
	Weighted Energy Intensity (kWh/AF)	241	275	264	354	278	157	262
Colorado River Aqueduct <sup>3</sup> (2000 kWh/AF)	Volume (AF)	26,374	39,124	40,522	25,445	33,098	93,047	37,012
	Treatment Energy Intensity (kWh/AF) <sup>2</sup>	27	27	27	27	27	27	27
	Weighted Energy Intensity (kWh/AF)	80	119	134	81	101	293	133
Local Groundwater (530 kWh/AF)	Volume (AF)	90,835	71,831	56,547	63,270	89,018	60,149	64,996
	Weighted Energy Intensity (kWh/AF)	72	57	49	53	71	50	61
Recycled Water <sup>4</sup> (1,139 kWh/AF)	Volume (AF)	1,759	1,774	1,401	4,890	3,639	7,081	7,489
	Weighted Energy Intensity	3	3	3	9	6	13	15
Distribution (196 kWh/AF)	Volume (AF)	664,108	668,300	612,373	635,017	661,814	642,879	562,480
	Weighted Energy Intensity (kWh/AF)	196	196	196	196	196	196	196
<b>Total Volume Delivered (AF)</b>		664,108	668,300	612,373	635,017	661,814	642,879	562,480
<b>Total Energy Intensity (kWh/AF)</b>		1,567	1,820	1,074	1,098	2,043	1,954	1,934

1. Los Angeles Aqueduct and State Water Project West Branch supplies are treated at the Los Angeles Aqueduct Filtration Plant

2. Colorado River Aqueduct and State Water Project East Branch supplies are treated at Weymouth and Diemer Filtration Plants operated by Metropolitan Water District of Southern California. The listed energy intensity is based on an average of the energy intensity for the two plants.

3. Amount of SWP water and CRA water delivered is based on the reported average ratio of the two sources in Weymouth Treatment Plant and Diemer Treatment Plant effluent from MWD annual Water Quality Report

4. Recycled water volume is based on use for municipal and industrial uses, not all beneficial uses. Energy intensity is a weighted average of energy used for pumping to customers and the incremental energy to treat from tertiary to advanced treatment.

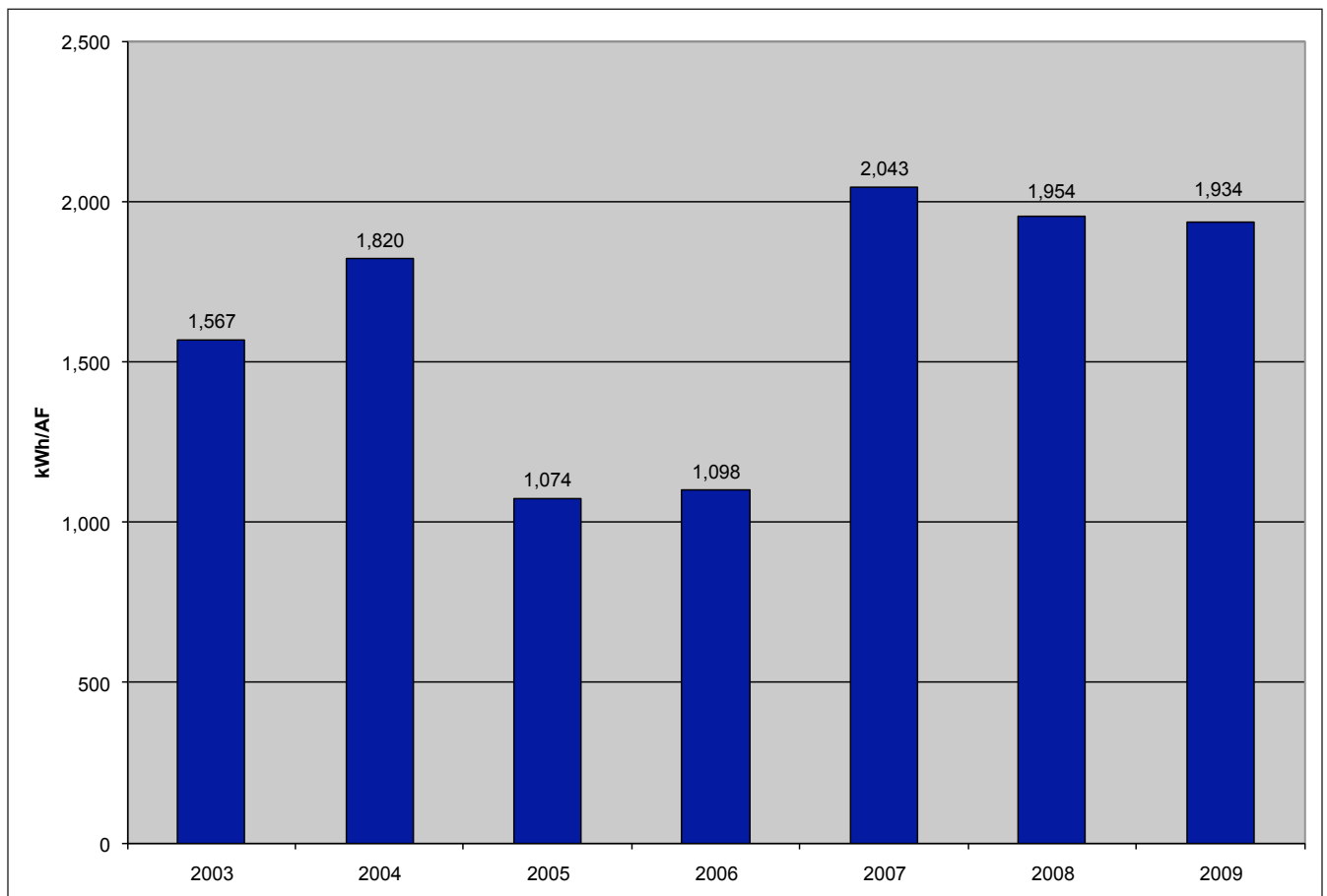
## 12.2.8 Carbon Footprint

All of LADWP's water supply sources have an associated carbon footprint related to the energy required to pump the water. Exhibit 12L provides the annual carbon footprint by water source. Exhibit 12M shows a graphical representation of the total annual carbon footprint for the same time period. For imported sources, the 2007 CAMX (Western Electricity Coordinating Council California Subregion name) California average carbon emission of 0.72412 lbs CO<sub>2</sub>/kWh was used to estimate the amount of carbon emissions produced per acre-foot of water imported. For local sources, the CO<sub>2</sub> metric LADWP

reported to the California Climate Action Registry in 2007 was used to estimate the carbon emissions released in the production of this water. LAA is a net producer of energy and produces only green hydropower. There are no carbon emissions associated with water imported through the LAA.

As Los Angeles increases its reliance on energy intensive imported supplies from MWD, its overall energy intensity will increase. Reductions in LAA flows due to environmental mitigation have the consequence of increasing Los Angeles' reliance on supplies imported through the SWP via the California Aqueduct, and Colorado River through the CRA.

**Exhibit 12K**  
**LADWP Annual Energy Intensity**





**Exhibit 12L**  
**Annual Footprint by Carbon Source**

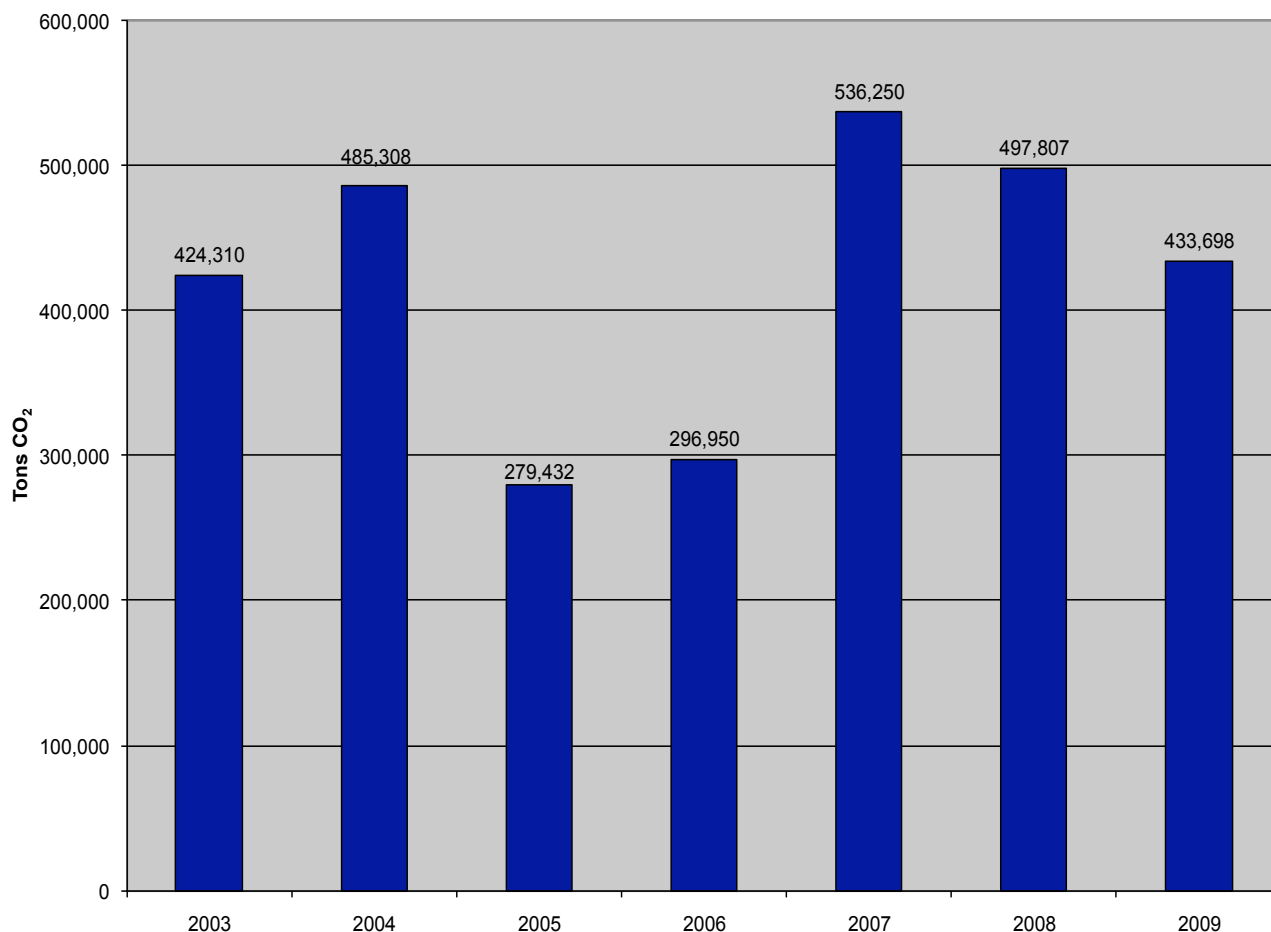
		2003	2004	2005	2006	2007	2008	2009
Los Angeles Aqueduct (0 kWh/AF)	Volume Delivered (AF)	251,942	202,547	368,839	378,922	129,400	147,365	137,084
	Energy Intensity (kWh/AF)	0	0	0	0	0	0	0
	Weighted Energy Intensity (kWh/AF)	13	10	20	20	7	8	8
	Carbon Footprint (tons CO <sub>2</sub> ) <sup>2</sup>	5,259	4,228	7,699	7,909	2,701	3,076	2,861
State Water Project West Branch (2,580 kWh/AF)	Volume Delivered (AF)	244,218	296,722	95,538	93,694	350,302	304,221	270,653
	Weighted Energy Intensity (kWh/AF)	961	1,161	408	386	1,384	1,237	1,258
	Carbon Footprint (tons CO <sub>2</sub> ) <sup>3</sup>	231,134	280,825	90,420	88,674	331,535	287,922	256,153
State Water Project East Branch (3,236 kWh/AF)	Volume Delivered (AF)	48,980	56,301	49,526	68,796	56,357	31,016	45,246
	Weighted Energy Intensity (kWh/AF)	241	275	264	354	278	157	262
	Carbon Footprint (tons CO <sub>2</sub> ) <sup>3</sup>	57,865	66,514	58,510	81,276	66,580	36,642	53,454
Colorado River Aqueduct <sup>1</sup> (2,000 kWh/AF)	Volume Delivered (AF)	26,374	39,124	40,522	25,445	33,098	93,047	37,012
	Weighted Energy Intensity (kWh/AF)	80	119	134	81	101	293	133
	Carbon Intensity (lbs CO <sub>2</sub> /kWh)	0.72412	0.72412	0.72412	0.72412	0.72412	0.72412	0.72412
	Carbon Footprint (tons CO <sub>2</sub> ) <sup>3</sup>	19,356	28,713	29,739	18,674	24,290	68,287	27,163
Local Groundwater (530 kWh/AF)	Volume Delivered (AF)	90,835	71,831	56,547	63,270	89,018	60,149	64,996
	Weighted Energy Intensity (kWh/AF)	72	57	49	53	71	50	61
	Carbon Footprint (tons CO <sub>2</sub> ) <sup>2</sup>	29,556	23,372	18,399	20,587	28,964	19,571	21,148
Recycled Water (1,139 kWh/AF)	Volume Delivered (AF)	1,759	1,774	1,401	4,890	3,639	7,081	7,489
	Weighted Energy Intensity (kWh/AF)	3	3	3	9	6	13	15
	Carbon Footprint (tons CO <sub>2</sub> ) <sup>2</sup>	1,230	1,240	980	3,419	2,545	4,951	5,237
Distribution (196 kWh/AF)	Volume Delivered (AF)	664,108	668,299	612,373	635,017	661,814	642,879	562,480
	Weighted Energy Intensity (kWh/AF)	196	196	196	196	196	196	196
	Carbon Footprint (tons CO <sub>2</sub> ) <sup>3</sup>	79,911	80,415	73,686	76,411	79,635	77,357	67,682
<b>Total Volume Delivered (AF)</b>		664,108	668,299	612,373	635,017	661,814	642,879	562,480
<b>Total Energy Intensity (kWh/AF)</b>		1,567	1,820	1,074	1,098	2,043	1,954	1,934
<b>Total Carbon Footprint (tons CO<sub>2</sub>)</b>		424,310	485,308	279,432	296,950	536,250	497,807	433,698

1. Amount of SWP water and CRA water delivered is based on average of the proportion of the two sources delivered to MWD Weymouth Treatment Plant and Diemer Treatment Plant for the calendar year

2. Based on 2007 CO<sub>2</sub> metric of 1.22789 lbs CO<sub>2</sub>/kWh reported to the California Climate Action Registry

3. Based on eGRID 2007 CAMX (California Average) of 0.72412 lbs CO<sub>2</sub>/kWh

**Exhibit 12M**  
**Total Annual Carbon Footprint for Water Supply Portfolio**



### 12.3 Climate Change Adaption and Mitigation

Climate change strategies fall under two main categories: adaptation and mitigation. For water resources planning, a climate change adaptation strategy involves taking steps to effectively manage the impacts of climate change by making water demands more efficient and relying on supply sources that are less vulnerable to climate change. A mitigation strategy involves proactive measures that reduce greenhouse gas emissions, such as placing a stronger emphasis on using water resources requiring less greenhouse gas emissions. Both LADWP

and its wholesale supplier for imported water, MWD, are implementing adaption and mitigation strategies as they become aware of potential climate change impacts.

It is imperative that supply options are carefully vetted and evaluated against both adaptation and mitigation goals, as they may conflict and work against each other. For example, desalination is a typical supply option that performs quite well in adapting to climate change impacts; however, due to the energy necessary to draw from and manage the supply source, it could result in higher greenhouse gas emissions if conventional energy sources are utilized.

### 12.3.1 LADWP Adaption and Mitigation

---

LADWP has outlined strategies to dramatically increase conservation and water recycling. Increasing conservation and water recycling encompasses both adaption and mitigation goals to address climate change. The UWMP calls for reducing potable demands by an additional 64,368 AFY through conservation and 59,000 AFY of additional recycled water use by fiscal year 2030. Additional adaption strategies under investigation by LADWP and the City includes beneficial reuse of stormwater as discussed in Chapters Seven and Nine, Watershed Management and Other Potential Water Supplies, respectively.

Conservation has a double savings in terms of energy intensity because not only does it save energy in importing or producing the water, but it also saves energy through reduction of end use, such as heating water for a shower or for a dishwasher and wastewater treatment. The anticipated conservation savings will not only help to provide Los Angeles a

secure and dependable water supply, but it will also reduce the energy footprint of the water supply, and consequently the carbon footprint. A further discussion regarding conservation is provided in Chapter Three, Conservation.

Recycled water use reduces reliance on potable water imported through MWD and provides a year round drought resistant water supply source. While the energy consumption requirements to produce recycled water are greater than local and LAA supply sources, recycled water assists LADWP in bolstering its supply portfolio to address potential supply changes related to climate change. A further discussion regarding recycled water is provided in Chapter 4, Recycled Water.

There is still general uncertainty within the scientific community regarding the potential impacts of climate change for the City of Los Angeles. LADWP will continue to stay abreast of developments in climate change to better understand its potential implications to the City's water supplies to assist in further developing adaption and mitigation strategies.





### 12.3.2 MWD Adaption and Mitigation

---

MWD is taking an active approach to adapt and mitigate against climate changes in its operations. Adaption and mitigation measures include:

- Investments in local resources to diversify MWD’s water supply portfolio.
- Tracking climate change legislation – MWD provides input and direction on legislation.
- Collaborating on climate change with state, federal, and non-governmental agencies.
- Monitoring state and local climate change actions.
- Investigating the water supply and energy nexus.
- Coordinating with large water retailers.

- Integrating climate change into integrated resource planning as discussed in Chapter 10, Integrated Resource Planning.
- Sharing climate change knowledge and providing support – founding member of Water Utility Climate Alliance.
- Adopting energy management policies to support cost-effective and environmentally responsible programs, projects, and initiative.

MWD has also taken structural adaption measures including construction of the Inland Feeder. The Inland Feeder completed in 2009 connects SWP supplies with MWD’s CRA supplies and allows delivery of SWP supplies to MWD’s major reservoir, Diamond Valley Lake. In relation to climate change, the project will increase conveyance capacity allowing more rain to be conveyed as projected snowpack levels decrease and allow MWD to capture rain associated with projected short duration high intensity storms.





## **Urban Water Management Planning Act**





# CALIFORNIA WATER CODE DIVISION 6

## PART 2.6. URBAN WATER MANAGEMENT PLANNING

All California Codes have been updated to include the 2010 Statutes.

CHAPTER 1.	GENERAL DECLARATION AND POLICY	<a href="#">10610-10610.4</a>
CHAPTER 2.	DEFINITIONS	<a href="#">10611-10617</a>
CHAPTER 3.	URBAN WATER MANAGEMENT PLANS	
Article 1.	General Provisions	<a href="#">10620-10621</a>
Article 2.	Contents of Plans	<a href="#">10630-10634</a>
Article 2.5.	Water Service Reliability	<a href="#">10635</a>
Article 3.	Adoption and Implementation of Plans	<a href="#">10640-10645</a>
CHAPTER 4.	MISCELLANEOUS PROVISIONS	<a href="#">10650-10656</a>

### WATER CODE

#### SECTION 10610-10610.4

**10610.** This part shall be known and may be cited as the "Urban Water Management Planning Act."

**10610.2.** (a) The Legislature finds and declares all of the following:

- (1) The waters of the state are a limited and renewable resource subject to ever-increasing demands.
- (2) The conservation and efficient use of urban water supplies are of statewide concern; however, the planning for that use and the implementation of those plans can best be accomplished at the local level.
- (3) A long-term, reliable supply of water is essential to protect the productivity of California's businesses and economic climate.
- (4) As part of its long-range planning activities, every urban water supplier should make every effort to ensure the appropriate level of reliability in its water service sufficient to meet the needs of its various categories of customers during normal, dry, and multiple dry water years.
- (5) Public health issues have been raised over a number of contaminants that have been identified in certain local and imported water supplies.
- (6) Implementing effective water management strategies, including groundwater storage projects and recycled water projects, may require specific water quality and salinity targets for meeting groundwater basins water quality objectives and promoting beneficial use of recycled water.
- (7) Water quality regulations are becoming an increasingly important factor in water agencies' selection of raw water sources, treatment alternatives, and modifications to existing treatment facilities.
- (8) Changes in drinking water quality standards may also impact the usefulness of water supplies and may ultimately impact supply reliability.
- (9) The quality of source supplies can have a significant impact

on water management strategies and supply reliability.

(b) This part is intended to provide assistance to water agencies in carrying out their long-term resource planning responsibilities to ensure adequate water supplies to meet existing and future demands for water.

**10610.4.** The Legislature finds and declares that it is the policy of the state as follows:

(a) The management of urban water demands and efficient use of water shall be actively pursued to protect both the people of the state and their water resources.

(b) The management of urban water demands and efficient use of urban water supplies shall be a guiding criterion in public decisions.

(c) Urban water suppliers shall be required to develop water management plans to actively pursue the efficient use of available supplies.

## **WATER CODE**

### **SECTION 10611-10617**

**10611.** Unless the context otherwise requires, the definitions of this chapter govern the construction of this part.

**10611.5.** "Demand management" means those water conservation measures, programs, and incentives that prevent the waste of water and promote the reasonable and efficient use and reuse of available supplies.

**10612.** "Customer" means a purchaser of water from a water supplier who uses the water for municipal purposes, including residential, commercial, governmental, and industrial uses.

**10613.** "Efficient use" means those management measures that result in the most effective use of water so as to prevent its waste or unreasonable use or unreasonable method of use.

**10614.** "Person" means any individual, firm, association, organization, partnership, business, trust, corporation, company, public agency, or any agency of such an entity.

**10615.** "Plan" means an urban water management plan prepared pursuant to this part. A plan shall describe and evaluate sources of supply, reasonable and practical efficient uses, reclamation and demand management activities. The components of the plan may vary according to an individual community or area's characteristics and its capabilities to efficiently use and conserve water. The plan shall address measures for residential, commercial, governmental, and industrial water demand management as set forth in Article 2 (commencing with Section 10630) of Chapter 3. In addition, a strategy and time schedule for implementation shall be included in the plan.

**10616.** "Public agency" means any board, commission, county, city

and county, city, regional agency, district, or other public entity.

**10616.5.** "Recycled water" means the reclamation and reuse of wastewater for beneficial use.

**10617.** "Urban water supplier" means a supplier, either publicly or privately owned, providing water for municipal purposes either directly or indirectly to more than 3,000 customers or supplying more than 3,000 acre-feet of water annually. An urban water supplier includes a supplier or contractor for water, regardless of the basis of right, which distributes or sells for ultimate resale to customers. This part applies only to water supplied from public water systems subject to Chapter 4 (commencing with Section 116275) of Part 12 of Division 104 of the Health and Safety Code.

## **WATER CODE**

### **SECTION 10620-10621**

**10620.** (a) Every urban water supplier shall prepare and adopt an urban water management plan in the manner set forth in Article 3 (commencing with Section 10640).

(b) Every person that becomes an urban water supplier shall adopt an urban water management plan within one year after it has become an urban water supplier.

(c) An urban water supplier indirectly providing water shall not include planning elements in its water management plan as provided in Article 2 (commencing with Section 10630) that would be applicable to urban water suppliers or public agencies directly providing water, or to their customers, without the consent of those suppliers or public agencies.

(d) (1) An urban water supplier may satisfy the requirements of this part by participation in areawide, regional, watershed, or basinwide urban water management planning where those plans will reduce preparation costs and contribute to the achievement of conservation and efficient water use.

(2) Each urban water supplier shall coordinate the preparation of its plan with other appropriate agencies in the area, including other water suppliers that share a common source, water management agencies, and relevant public agencies, to the extent practicable.

(e) The urban water supplier may prepare the plan with its own staff, by contract, or in cooperation with other governmental agencies.

(f) An urban water supplier shall describe in the plan water management tools and options used by that entity that will maximize resources and minimize the need to import water from other regions.

**10621.** (a) Each urban water supplier shall update its plan at least once every five years on or before December 31, in years ending in five and zero.

(b) Every urban water supplier required to prepare a plan pursuant to this part shall, at least 60 days prior to the public hearing on the plan required by Section 10642, notify any city or county within which the supplier provides water supplies that the urban water

supplier will be reviewing the plan and considering amendments or changes to the plan. The urban water supplier may consult with, and obtain comments from, any city or county that receives notice pursuant to this subdivision.

(c) The amendments to, or changes in, the plan shall be adopted and filed in the manner set forth in Article 3 (commencing with Section 10640).

## **WATER CODE**

### **SECTION 10630-10634**

**10630.** It is the intention of the Legislature, in enacting this part, to permit levels of water management planning commensurate with the numbers of customers served and the volume of water supplied.

**10631.** A plan shall be adopted in accordance with this chapter that shall do all of the following:

(a) Describe the service area of the supplier, including current and projected population, climate, and other demographic factors affecting the supplier's water management planning. The projected population estimates shall be based upon data from the state, regional, or local service agency population projections within the service area of the urban water supplier and shall be in five-year increments to 20 years or as far as data is available.

(b) Identify and quantify, to the extent practicable, the existing and planned sources of water available to the supplier over the same five-year increments described in subdivision (a). If groundwater is identified as an existing or planned source of water available to the supplier, all of the following information shall be included in the plan:

(1) A copy of any groundwater management plan adopted by the urban water supplier, including plans adopted pursuant to Part 2.75 (commencing with Section 10750), or any other specific authorization for groundwater management.

(2) A description of any groundwater basin or basins from which the urban water supplier pumps groundwater. For those basins for which a court or the board has adjudicated the rights to pump groundwater, a copy of the order or decree adopted by the court or the board and a description of the amount of groundwater the urban water supplier has the legal right to pump under the order or decree. For basins that have not been adjudicated, information as to whether the department has identified the basin or basins as overdrafted or has projected that the basin will become overdrafted if present management conditions continue, in the most current official departmental bulletin that characterizes the condition of the groundwater basin, and a detailed description of the efforts being undertaken by the urban water supplier to eliminate the long-term overdraft condition.

(3) A detailed description and analysis of the location, amount, and sufficiency of groundwater pumped by the urban water supplier for the past five years. The description and analysis shall be based on information that is reasonably available, including, but not limited to, historic use records.

(4) A detailed description and analysis of the amount and location of groundwater that is projected to be pumped by the urban water supplier. The description and analysis shall be based on information that is reasonably available, including, but not limited to, historic use records.

(c) (1) Describe the reliability of the water supply and vulnerability to seasonal or climatic shortage, to the extent practicable, and provide data for each of the following:

- (A) An average water year.
- (B) A single dry water year.
- (C) Multiple dry water years.

(2) For any water source that may not be available at a consistent level of use, given specific legal, environmental, water quality, or climatic factors, describe plans to supplement or replace that source with alternative sources or water demand management measures, to the extent practicable.

(d) Describe the opportunities for exchanges or transfers of water on a short-term or long-term basis.

(e) (1) Quantify, to the extent records are available, past and current water use, over the same five-year increments described in subdivision (a), and projected water use, identifying the uses among water use sectors, including, but not necessarily limited to, all of the following uses:

- (A) Single-family residential.
- (B) Multifamily.
- (C) Commercial.
- (D) Industrial.
- (E) Institutional and governmental.
- (F) Landscape.
- (G) Sales to other agencies.
- (H) Saline water intrusion barriers, groundwater recharge, or conjunctive use, or any combination thereof.

(I) Agricultural.

(2) The water use projections shall be in the same five-year increments described in subdivision (a).

(f) Provide a description of the supplier's water demand management measures. This description shall include all of the following:

(1) A description of each water demand management measure that is currently being implemented, or scheduled for implementation, including the steps necessary to implement any proposed measures, including, but not limited to, all of the following:

- (A) Water survey programs for single-family residential and multifamily residential customers.
- (B) Residential plumbing retrofit.
- (C) System water audits, leak detection, and repair.
- (D) Metering with commodity rates for all new connections and retrofit of existing connections.
- (E) Large landscape conservation programs and incentives.
- (F) High-efficiency washing machine rebate programs.
- (G) Public information programs.
- (H) School education programs.
- (I) Conservation programs for commercial, industrial, and institutional accounts.

- (J) Wholesale agency programs.
- (K) Conservation pricing.
- (L) Water conservation coordinator.
- (M) Water waste prohibition.
- (N) Residential ultra-low-flush toilet replacement programs.
- (2) A schedule of implementation for all water demand management measures proposed or described in the plan.
- (3) A description of the methods, if any, that the supplier will use to evaluate the effectiveness of water demand management measures implemented or described under the plan.
- (4) An estimate, if available, of existing conservation savings on water use within the supplier's service area, and the effect of the savings on the supplier's ability to further reduce demand.
- (g) An evaluation of each water demand management measure listed in paragraph (1) of subdivision (f) that is not currently being implemented or scheduled for implementation. In the course of the evaluation, first consideration shall be given to water demand management measures, or combination of measures, that offer lower incremental costs than expanded or additional water supplies. This evaluation shall do all of the following:
  - (1) Take into account economic and noneconomic factors, including environmental, social, health, customer impact, and technological factors.
  - (2) Include a cost-benefit analysis, identifying total benefits and total costs.
  - (3) Include a description of funding available to implement any planned water supply project that would provide water at a higher unit cost.
  - (4) Include a description of the water supplier's legal authority to implement the measure and efforts to work with other relevant agencies to ensure the implementation of the measure and to share the cost of implementation.
- (h) Include a description of all water supply projects and water supply programs that may be undertaken by the urban water supplier to meet the total projected water use as established pursuant to subdivision (a) of Section 10635. The urban water supplier shall include a detailed description of expected future projects and programs, other than the demand management programs identified pursuant to paragraph (1) of subdivision (f), that the urban water supplier may implement to increase the amount of the water supply available to the urban water supplier in average, single-dry, and multiple-dry water years. The description shall identify specific projects and include a description of the increase in water supply that is expected to be available from each project. The description shall include an estimate with regard to the implementation timeline for each project or program.
- (i) Describe the opportunities for development of desalinated water, including, but not limited to, ocean water, brackish water, and groundwater, as a long-term supply.
- (j) For purposes of this part, urban water suppliers that are members of the California Urban Water Conservation Council shall be deemed in compliance with the requirements of subdivisions (f) and (g) by complying with all the provisions of the "Memorandum of Understanding Regarding Urban Water Conservation in California,"

dated December 10, 2008, as it may be amended, and by submitting the annual reports required by Section 6.2 of that memorandum.

(k) Urban water suppliers that rely upon a wholesale agency for a source of water shall provide the wholesale agency with water use projections from that agency for that source of water in five-year increments to 20 years or as far as data is available. The wholesale agency shall provide information to the urban water supplier for inclusion in the urban water supplier's plan that identifies and quantifies, to the extent practicable, the existing and planned sources of water as required by subdivision (b), available from the wholesale agency to the urban water supplier over the same five-year increments, and during various water-year types in accordance with subdivision (c). An urban water supplier may rely upon water supply information provided by the wholesale agency in fulfilling the plan informational requirements of subdivisions (b) and (c).

**10631.1.** (a) The water use projections required by Section 10631 shall include projected water use for single-family and multifamily residential housing needed for lower income households, as defined in Section 50079.5 of the Health and Safety Code, as identified in the housing element of any city, county, or city and county in the service area of the supplier.

(b) It is the intent of the Legislature that the identification of projected water use for single-family and multifamily residential housing for lower income households will assist a supplier in complying with the requirement under Section 65589.7 of the Government Code to grant a priority for the provision of service to housing units affordable to lower income households.

**10631.5.** (a) (1) Beginning January 1, 2009, the terms of, and eligibility for, a water management grant or loan made to an urban water supplier and awarded or administered by the department, state board, or California Bay-Delta Authority or its successor agency shall be conditioned on the implementation of the water demand management measures described in Section 10631, as determined by the department pursuant to subdivision (b).

(2) For the purposes of this section, water management grants and loans include funding for programs and projects for surface water or groundwater storage, recycling, desalination, water conservation, water supply reliability, and water supply augmentation. This section does not apply to water management projects funded by the federal American Recovery and Reinvestment Act of 2009 (Public Law 111-5).

(3) Notwithstanding paragraph (1), the department shall determine that an urban water supplier is eligible for a water management grant or loan even though the supplier is not implementing all of the water demand management measures described in Section 10631, if the urban water supplier has submitted to the department for approval a schedule, financing plan, and budget, to be included in the grant or loan agreement, for implementation of the water demand management measures. The supplier may request grant or loan funds to implement the water demand management measures to the extent the request is consistent with the eligibility requirements applicable to the water management funds.

(4) (A) Notwithstanding paragraph (1), the department shall

determine that an urban water supplier is eligible for a water management grant or loan even though the supplier is not implementing all of the water demand management measures described in Section 10631, if an urban water supplier submits to the department for approval documentation demonstrating that a water demand management measure is not locally cost effective. If the department determines that the documentation submitted by the urban water supplier fails to demonstrate that a water demand management measure is not locally cost effective, the department shall notify the urban water supplier and the agency administering the grant or loan program within 120 days that the documentation does not satisfy the requirements for an exemption, and include in that notification a detailed statement to support the determination.

(B) For purposes of this paragraph, "not locally cost effective" means that the present value of the local benefits of implementing a water demand management measure is less than the present value of the local costs of implementing that measure.

(b) (1) The department, in consultation with the state board and the California Bay-Delta Authority or its successor agency, and after soliciting public comment regarding eligibility requirements, shall develop eligibility requirements to implement the requirement of paragraph (1) of subdivision (a). In establishing these eligibility requirements, the department shall do both of the following:

(A) Consider the conservation measures described in the Memorandum of Understanding Regarding Urban Water Conservation in California, and alternative conservation approaches that provide equal or greater water savings.

(B) Recognize the different legal, technical, fiscal, and practical roles and responsibilities of wholesale water suppliers and retail water suppliers.

(2) (A) For the purposes of this section, the department shall determine whether an urban water supplier is implementing all of the water demand management measures described in Section 10631 based on either, or a combination, of the following:

(i) Compliance on an individual basis.

(ii) Compliance on a regional basis. Regional compliance shall require participation in a regional conservation program consisting of two or more urban water suppliers that achieves the level of conservation or water efficiency savings equivalent to the amount of conservation or savings achieved if each of the participating urban water suppliers implemented the water demand management measures. The urban water supplier administering the regional program shall provide participating urban water suppliers and the department with data to demonstrate that the regional program is consistent with this clause. The department shall review the data to determine whether the urban water suppliers in the regional program are meeting the eligibility requirements.

(B) The department may require additional information for any determination pursuant to this section.

(3) The department shall not deny eligibility to an urban water supplier in compliance with the requirements of this section that is participating in a multiagency water project, or an integrated regional water management plan, developed pursuant to Section 75026 of the Public Resources Code, solely on the basis that one or more of



the agencies participating in the project or plan is not implementing all of the water demand management measures described in Section 10631.

(c) In establishing guidelines pursuant to the specific funding authorization for any water management grant or loan program subject to this section, the agency administering the grant or loan program shall include in the guidelines the eligibility requirements developed by the department pursuant to subdivision (b).

(d) Upon receipt of a water management grant or loan application by an agency administering a grant and loan program subject to this section, the agency shall request an eligibility determination from the department with respect to the requirements of this section. The department shall respond to the request within 60 days of the request.

(e) The urban water supplier may submit to the department copies of its annual reports and other relevant documents to assist the department in determining whether the urban water supplier is implementing or scheduling the implementation of water demand management activities. In addition, for urban water suppliers that are signatories to the Memorandum of Understanding Regarding Urban Water Conservation in California and submit biennial reports to the California Urban Water Conservation Council in accordance with the memorandum, the department may use these reports to assist in tracking the implementation of water demand management measures.

(f) This section shall remain in effect only until July 1, 2016, and as of that date is repealed, unless a later enacted statute, that is enacted before July 1, 2016, deletes or extends that date.

**10631.7.** The department, in consultation with the California Urban Water Conservation Council, shall convene an independent technical panel to provide information and recommendations to the department and the Legislature on new demand management measures, technologies, and approaches. The panel shall consist of no more than seven members, who shall be selected by the department to reflect a balanced representation of experts. The panel shall have at least one, but no more than two, representatives from each of the following: retail water suppliers, environmental organizations, the business community, wholesale water suppliers, and academia. The panel shall be convened by January 1, 2009, and shall report to the Legislature no later than January 1, 2010, and every five years thereafter. The department shall review the panel report and include in the final report to the Legislature the department's recommendations and comments regarding the panel process and the panel's recommendations.

**10632.** (a) The plan shall provide an urban water shortage contingency analysis that includes each of the following elements that are within the authority of the urban water supplier:

(1) Stages of action to be undertaken by the urban water supplier in response to water supply shortages, including up to a 50 percent reduction in water supply, and an outline of specific water supply conditions that are applicable to each stage.

(2) An estimate of the minimum water supply available during each of the next three water years based on the driest three-year historic

sequence for the agency's water supply.

(3) Actions to be undertaken by the urban water supplier to prepare for, and implement during, a catastrophic interruption of water supplies including, but not limited to, a regional power outage, an earthquake, or other disaster.

(4) Additional, mandatory prohibitions against specific water use practices during water shortages, including, but not limited to, prohibiting the use of potable water for street cleaning.

(5) Consumption reduction methods in the most restrictive stages. Each urban water supplier may use any type of consumption reduction methods in its water shortage contingency analysis that would reduce water use, are appropriate for its area, and have the ability to achieve a water use reduction consistent with up to a 50 percent reduction in water supply.

(6) Penalties or charges for excessive use, where applicable.

(7) An analysis of the impacts of each of the actions and conditions described in paragraphs (1) to (6), inclusive, on the revenues and expenditures of the urban water supplier, and proposed measures to overcome those impacts, such as the development of reserves and rate adjustments.

(8) A draft water shortage contingency resolution or ordinance.

(9) A mechanism for determining actual reductions in water use pursuant to the urban water shortage contingency analysis.

(b) Commencing with the urban water management plan update due December 31, 2015, for purposes of developing the water shortage contingency analysis pursuant to subdivision (a), the urban water supplier shall analyze and define water features that are artificially supplied with water, including ponds, lakes, waterfalls, and fountains, separately from swimming pools and spas, as defined in subdivision (a) of Section 115921 of the Health and Safety Code.

**10633.** The plan shall provide, to the extent available, information on recycled water and its potential for use as a water source in the service area of the urban water supplier. The preparation of the plan shall be coordinated with local water, wastewater, groundwater, and planning agencies that operate within the supplier's service area, and shall include all of the following:

(a) A description of the wastewater collection and treatment systems in the supplier's service area, including a quantification of the amount of wastewater collected and treated and the methods of wastewater disposal.

(b) A description of the quantity of treated wastewater that meets recycled water standards, is being discharged, and is otherwise available for use in a recycled water project.

(c) A description of the recycled water currently being used in the supplier's service area, including, but not limited to, the type, place, and quantity of use.

(d) A description and quantification of the potential uses of recycled water, including, but not limited to, agricultural irrigation, landscape irrigation, wildlife habitat enhancement, wetlands, industrial reuse, groundwater recharge, indirect potable reuse, and other appropriate uses, and a determination with regard to the technical and economic feasibility of serving those uses.

(e) The projected use of recycled water within the supplier's

service area at the end of 5, 10, 15, and 20 years, and a description of the actual use of recycled water in comparison to uses previously projected pursuant to this subdivision.

(f) A description of actions, including financial incentives, which may be taken to encourage the use of recycled water, and the projected results of these actions in terms of acre-feet of recycled water used per year.

(g) A plan for optimizing the use of recycled water in the supplier's service area, including actions to facilitate the installation of dual distribution systems, to promote recirculating uses, to facilitate the increased use of treated wastewater that meets recycled water standards, and to overcome any obstacles to achieving that increased use.

**10634.** The plan shall include information, to the extent practicable, relating to the quality of existing sources of water available to the supplier over the same five-year increments as described in subdivision (a) of Section 10631, and the manner in which water quality affects water management strategies and supply reliability.

## **WATER CODE**

### **SECTION 10635**

**10635.** (a) Every urban water supplier shall include, as part of its urban water management plan, an assessment of the reliability of its water service to its customers during normal, dry, and multiple dry water years. This water supply and demand assessment shall compare the total water supply sources available to the water supplier with the total projected water use over the next 20 years, in five-year increments, for a normal water year, a single dry water year, and multiple dry water years. The water service reliability assessment shall be based upon the information compiled pursuant to Section 10631, including available data from state, regional, or local agency population projections within the service area of the urban water supplier.

(b) The urban water supplier shall provide that portion of its urban water management plan prepared pursuant to this article to any city or county within which it provides water supplies no later than 60 days after the submission of its urban water management plan.

(c) Nothing in this article is intended to create a right or entitlement to water service or any specific level of water service.

(d) Nothing in this article is intended to change existing law concerning an urban water supplier's obligation to provide water service to its existing customers or to any potential future customers.

## **WATER CODE**

### **SECTION 10640-10645**

**10640.** Every urban water supplier required to prepare a plan pursuant to this part shall prepare its plan pursuant to Article 2 (commencing with Section 10630).

The supplier shall likewise periodically review the plan as required by Section 10621, and any amendments or changes required as a result of that review shall be adopted pursuant to this article.

**10641.** An urban water supplier required to prepare a plan may consult with, and obtain comments from, any public agency or state agency or any person who has special expertise with respect to water demand management methods and techniques.

**10642.** Each urban water supplier shall encourage the active involvement of diverse social, cultural, and economic elements of the population within the service area prior to and during the preparation of the plan. Prior to adopting a plan, the urban water supplier shall make the plan available for public inspection and shall hold a public hearing thereon. Prior to the hearing, notice of the time and place of hearing shall be published within the jurisdiction of the publicly owned water supplier pursuant to Section 6066 of the Government Code. The urban water supplier shall provide notice of the time and place of hearing to any city or county within which the supplier provides water supplies. A privately owned water supplier shall provide an equivalent notice within its service area. After the hearing, the plan shall be adopted as prepared or as modified after the hearing.

**10643.** An urban water supplier shall implement its plan adopted pursuant to this chapter in accordance with the schedule set forth in its plan.

**10644.** (a) An urban water supplier shall submit to the department, the California State Library, and any city or county within which the supplier provides water supplies a copy of its plan no later than 30 days after adoption. Copies of amendments or changes to the plans shall be submitted to the department, the California State Library, and any city or county within which the supplier provides water supplies within 30 days after adoption.

(b) The department shall prepare and submit to the Legislature, on or before December 31, in the years ending in six and one, a report summarizing the status of the plans adopted pursuant to this part. The report prepared by the department shall identify the exemplary elements of the individual plans. The department shall provide a copy of the report to each urban water supplier that has submitted its plan to the department. The department shall also prepare reports and provide data for any legislative hearings designed to consider the effectiveness of plans submitted pursuant to this part.

(c) (1) For the purpose of identifying the exemplary elements of the individual plans, the department shall identify in the report those water demand management measures adopted and implemented by specific urban water suppliers, and identified pursuant to Section

10631, that achieve water savings significantly above the levels established by the department to meet the requirements of Section 10631.5.

(2) The department shall distribute to the panel convened pursuant to Section 10631.7 the results achieved by the implementation of those water demand management measures described in paragraph (1).

(3) The department shall make available to the public the standard the department will use to identify exemplary water demand management measures.

**10645.** Not later than 30 days after filing a copy of its plan with the department, the urban water supplier and the department shall make the plan available for public review during normal business hours.

## **WATER CODE**

### **SECTION 10650-10656**

**10650.** Any actions or proceedings to attack, review, set aside, void, or annul the acts or decisions of an urban water supplier on the grounds of noncompliance with this part shall be commenced as follows:

(a) An action or proceeding alleging failure to adopt a plan shall be commenced within 18 months after that adoption is required by this part.

(b) Any action or proceeding alleging that a plan, or action taken pursuant to the plan, does not comply with this part shall be commenced within 90 days after filing of the plan or amendment thereto pursuant to Section 10644 or the taking of that action.

**10651.** In any action or proceeding to attack, review, set aside, void, or annul a plan, or an action taken pursuant to the plan by an urban water supplier on the grounds of noncompliance with this part, the inquiry shall extend only to whether there was a prejudicial abuse of discretion. Abuse of discretion is established if the supplier has not proceeded in a manner required by law or if the action by the water supplier is not supported by substantial evidence.

**10652.** The California Environmental Quality Act (Division 13 (commencing with Section 21000) of the Public Resources Code) does not apply to the preparation and adoption of plans pursuant to this part or to the implementation of actions taken pursuant to Section 10632. Nothing in this part shall be interpreted as exempting from the California Environmental Quality Act any project that would significantly affect water supplies for fish and wildlife, or any project for implementation of the plan, other than projects implementing Section 10632, or any project for expanded or additional water supplies.

**10653.** The adoption of a plan shall satisfy any requirements of state law, regulation, or order, including those of the State Water Resources Control Board and the Public Utilities Commission, for the preparation of water management plans or conservation plans; provided, that if the State Water Resources Control Board or the Public Utilities Commission requires additional information concerning water conservation to implement its existing authority, nothing in this part shall be deemed to limit the board or the commission in obtaining that information. The requirements of this part shall be satisfied by any urban water demand management plan prepared to meet federal laws or regulations after the effective date of this part, and which substantially meets the requirements of this part, or by any existing urban water management plan which includes the contents of a plan required under this part.

**10654.** An urban water supplier may recover in its rates the costs incurred in preparing its plan and implementing the reasonable water conservation measures included in the plan. Any best water management practice that is included in the plan that is identified in the

"Memorandum of Understanding Regarding Urban Water Conservation in California" is deemed to be reasonable for the purposes of this section.

**10655.** If any provision of this part or the application thereof to any person or circumstances is held invalid, that invalidity shall not affect other provisions or applications of this part which can be given effect without the invalid provision or application thereof, and to this end the provisions of this part are severable.

**10656.** An urban water supplier that does not prepare, adopt, and submit its urban water management plan to the department in accordance with this part, is ineligible to receive funding pursuant to Division 24 (commencing with Section 78500) or Division 26 (commencing with Section 79000), or receive drought assistance from the state until the urban water management plan is submitted pursuant to this article.





## **Urban Water Management Plan Checklist and Standard Tables**



## 2010 UWMP Checklist

No.	UWMP Requirements	CA Water Code Reference	Subject	UWMP Location	UWMP Guidebook Standardized Table Locations	Additional Clarification
1	Provide baseline daily per capita water use, urban water use target, interim urban water use target, and compliance daily per capita water use, along with the bases for determining those estimates, including references to supporting data.	10608.20(e)	System Demands	p 51-52 (Sec 3.1.2), Appendix G (2020 Water Use Target)	13, 14, 15	
2	Wholesalers: Include an assessment of present and proposed future measures, programs, and policies to help achieve the water use reductions. Retailers: Conduct at least one public hearing that includes general discussion of the urban retail water suppliers' implementation plan for complying with the Water Conservation Bill of 2009.	10608.36, 10608.26 (a)	System Demands	Appendix D - Four public workshops were held on 1/2/10, 1/20/10, 2/3/11, & 2/9/11. Final public hearings for the adoption was held on 5/3/11.	Not Applicable	
3	Report progress in meeting urban water use targets using the standardized form.	10608.40	Not Applicable	Standardized form not yet available	Not Applicable	
4	Each urban water supplier shall coordinate the preparation of its plan with other appropriate agencies in the area, including other water suppliers that share a common source, water management agencies, and relevant public agencies, to the extent practicable	10620(d)(2)	Plan Preparation	Various pages reference reports, communication, and coordination with City Planning, Bureau of Sanitation, MWD, SCAG, TreePeople, and other agencies & stakeholders. Appendix D documents public involvements.	1	
5	An urban water supplier shall describe in the plan water management tools and options used by that entity that will maximize resources and minimize the need to import water from other regions.	10620(f)	Water Supply Reliability	p 1	Not Applicable	
6	Every urban water supplier required to prepare a plan pursuant to this part shall, at least 60 days prior to the public hearing on the plan required by Section 10642, notify any city or county within which the supplier provides water supplies that the urban water supplier will be reviewing the plan and considering amendments of changes to the plan. The urban water supplier may consult with, and obtain comments from, any city or county that receives notice pursuant to this subdivision.	10621(b)	Plan Preparation	Appendix D (Notice of Meeting & Public Comments)	Not Applicable	
7	The amendments to, or changes in, the plan shall be adopted and filed in the manner set forth in Article 3 (commencing with Section 10640).	10621(c)	Plan Preparation	To be enclosed with transmittal letter to DWR.	Not Applicable	
8	Describe the service area of the supplier	10631(a)	System Description	p 1 & 30 (Sec 1.2)	Not Applicable	
9	(Describe the service area) climate	10631(a)	System Description	p 34 (Sec 1.2.3 & Exhibit 1E)	Not Applicable	
10	(Describe the service area) current and projected population . . . The projected population estimates shall be based upon data from the state, regional, or local service agency population projections within the service area of the urban water supplier...	10631(a)	System Description	p 31-33 (Sec 1.2.2)	2	Provide the most recent population data possible. Use the method described in "Baseline Daily Per Capita Water Use." See Section M.
11	. . . (population projections) shall be in five-year increments to 20 years or as far as data is available.	10631(a)	System Description	p 32 (Exhibit 1C)	2	2035 and 2040 can also be provided to support consistency with Water Supply Assessments and Written Verification of Water Supply Documents
12	Describe . . . other demographic factors affecting the supplier's water management planning	10631(a)	System Description	p 32 (Exhibit 1C), p 43 (Exhibit 2G), p 44 (socioeconomic variables)	Not Applicable	
13	Identify and quantify, to the extent practicable, the existing and planned sources of water available to the supplier over the same five-year increments described in subdivision (a).	10631(b)	System Supplies	p 229 (Exhibit 11E)	16	The "existing" water sources should be for the same year as the "current population" in line 10. 2035 and 2040 can also be provided to support consistency with Water Supply Assessments and Written Verification of Water Supply documents.
14	(Is) groundwater . . . identified as an existing or planned source of water available to the supplier . . . ?	10631(b)	System Supplies	p 123 (Exhibit 6B) & p 136 (Exhibit 6G)	18, 19	Source classifications are: surface water, groundwater, recycled water, storm water, desalinated sea water, desalinated brackish groundwater, and other.

## 2010 UWMP Checklist

No.	UWMP Requirements	CA Water Code Reference	Subject	UWMP Location	UWMP Guidebook Standardized Table Locations	Additional Clarification
15	(Provide a) copy of any groundwater management plan adopted by the urban water supplier, including plans adopted pursuant to Part 2.75 (commencing with Section 10750), or any other specific authorization for groundwater management. Indicate whether a groundwater management plan been adopted by the water supplier or if there is any other specific authorization for groundwater management. Include a copy of the plan or authorization.	10631(b)(1)	System Supplies	p 8 (Local Groundwater), Appendix F (Groundwater Basin Adjudications)	Not Applicable	
16	(Provide a) description of any groundwater basin or basins from which the urban water supplier pumps groundwater.	10631(b)(2)	System Supplies	p 123, 129, 130, 132 (description of individual basin)	Not Applicable	
17	For those basins for which a court or the board has adjudicated the rights to pump groundwater, (provide) a copy of the order or decree adopted by the court or the board	10631(b)(2)	System Supplies	Appendix F (Groundwater Basin Adjudications)	Not Applicable	
18	(Provide) a description of the amount of groundwater the urban water supplier has the legal right to pump under the order or decree.	10631(b)(2)	System Supplies	p 121 (Sec 6.1, Exhibit 6A)	Not Applicable	
19	For basins that have not been adjudicated, (provide) information as to whether the department has identified the basin or basins as overdrafted or has projected that the basin will become overdrafted if present management conditions continue. In the most current official departmental bulletin that characterizes the condition of the groundwater basin, and a detailed description of the efforts being undertaken by the urban water supplier to eliminate the long-term overdraft condition.	10631(b)(2)	System Supplies	Not Applicable	Not Applicable	
20	(Provide a) detailed description and analysis of the location, amount, and sufficiency of groundwater pumped by the urban water supplier for the past five years. The description and analysis shall be based on information that is reasonably available, including, but not limited to, historic use records	10631(b)(3)	System Supplies	p 121-132, Exhibit 6B	18	
21	(Provide a) detailed description and analysis of the amount and location of groundwater that is projected to be pumped by the urban water supplier. The description and analysis shall be based on information that is reasonably available, including, but not limited to, historic use records.	10631(b)(4)	System Supplies	p 136	19	Provide projections for 2015, 2020, 2025, and 2030.
22	Describe the reliability of the water supply and vulnerability to seasonal or climatic shortage, to the extent practicable, and provide data for each of the following: (A) An average water year, (B) A single dry water year, (C) Multiple dry water years.	10631(c)(1)	Water Supply Reliability	p 223-227 (Sec 11.2 with description), p 229-235 (data, Exhibits 11E-11K)	27, 28, 32, 33, 34	
23	For any water source that may not be available at a consistent level of use - given specific legal, environmental, water quality, or climatic factors - describe plans to supplement or replace that source with alternative sources or water demand management measures, to the extent practicable.	10631(c)(2)	Water Supply Reliability	Sec 11.2.3 to 11.2.7	29, 30	
24	Describe the opportunities for exchanges or transfers of water on a short-term or long-term basis.	10631(d)	System Supplies	p 195-199	20	

## 2010 UWMP Checklist

No.	UWMP Requirements	CA Water Code Reference	Subject	UWMP Location	UWMP Guidebook Standardized Table Locations	Additional Clarification
25	Quantify, to the extent records are available, past and current water use, and projected water use (over the same five-year increments described in subdivision (a)), identifying the uses among water use sectors, including, but not necessarily limited to, all of the following uses: (A) Single-family residential; (B) Multifamily; (C) Commercial; (D) Industrial; (E) Institutional and governmental; (F) Landscape; (G) Sales to other agencies; (H) Sakine water intrusion barriers, groundwater recharge, or conjunctive use, or any combination thereof; (I) Agricultural.	10631(e)(1)	System Demands	p 10 (Exhibit ES-G), p 45 (Exhibit 2J)	3, 4, 5, 6, 7, 11	Consider "past" to be 2005, present to be 2010, and projected to be 2015, 2020, 2025, and 2030. Provide numbers for each category for each of these years.
26	Describe and provide a schedule of implementation for each water demand management measure that is currently being implemented, or scheduled for implementation, including the steps necessary to implement any proposed measures, including, but not limited to, all of the following: (A) Water survey programs for single-family residential and multifamily residential customers; (B) Residential plumbing retrofit; (C) System water audits, leak detection, and repair; (D) Metering with commodity rates for all new connections and retrofit of existing connections; (E) Large landscape conservation programs and incentives; (F) High-efficiency washing machine rebate programs; (G) Public information programs; (H) School education programs; (I) Conservation programs for commercial, industrial, and institutional accounts; (J) Wholesale agency programs; (K) Conservation pricing; (L) Water conservation coordinator; (M) Water waste prohibition; (N) Residential ultralow-flush toilet replacement programs	10631(f)(1)	DMMs	p 52-70 (Sec 3.2)	Not Applicable	(A) Water Survey for Single and Multi-family residential customers: Exhibit 3F, Exhibit 3G, Section 3.2.4 - Residential Category (B) Residential Plumbing Retrofit: Section 3.2.1 and 3.2.4, Exhibit 3G (C) System Water Audits, Leak Detection, and Repair: Exhibit 3F, Exhibit 3G, Section 3.2.4 - System Maintenance Category (D) Metering with Commodity Rates for All New Connections and Retrofit of Existing Connections: Exhibit 3F, Exhibit 3G, Section 3.2.2 (E) Large Landscape Conservation Programs and Incentives: Exhibit 3F, Exhibit 3G, Section 3.2.4 - Landscape (F) High-Efficiency Washing Machine Rebate Programs: Exhibit 3F, Exhibit 3G, Section 3.2.4 - Residential (G) Public Information Programs: Exhibit 3F, Exhibit 3G, Section 3.2.4 - Awareness/Support Measures (H) School Education Programs: Exhibit 3F, Exhibit 3G, Section 3.2.4 - Awareness/Support Measures (I) Conservation Programs for Commercial, Industrial, and Institutional Accounts: Exhibit 3F, Exhibit 3G, Section 3.2.4 - Commercial/Industrial/Institutional Category (J) Wholesale Agency Programs: Not applicable (stated so in 3.2.3) (K) Conservation pricing: Section 3.2.2, Exhibit 3F, Exhibit 3G (L) Water Conservation Coordinator: Exhibit 3F, Exhibit 3G, Section 3.2.4 (M) Water Waste Prohibition: Section 3.2.1, Exhibit 3F, Exhibit 3G (N) Residential Ultralow-flush Toilet Replacement Programs: Exhibit 3F, Exhibit 3G, Section 3.2.4 - Residential Category
27	A description of the methods, if any, that the supplier will use to evaluate the effectiveness of water demand management measures implemented or described under the plan.	10631(f)(3)	DMMs	p 41-42 (Sec 2.2, Exhibits 2E & 2F), p 245-246 (Sec 11.3.9)	Not Applicable	
28	An estimate, if available, of existing conservation savings on water use within the supplier's service area, and the effect of the savings on the supplier's ability to future reduce demand.	10631(f)(4)	DMMs	p 49 (Exhibit 3B)	16	

## 2010 UWMP Checklist

No.	UWMP Requirements	CA Water Code Reference	Subject	UWMP Location	UWMP Guidebook Standardized Table Locations	Additional Clarification
29	<p>An evaluation of each water demand management measure listed in paragraph (1) of subdivision (f) that is not currently being implemented or scheduled for implementation. In the course of the evaluation, first consideration shall be given to water demand management measures, or combination of measures, that offer lower incremental costs than expanded or additional water supplies. This evaluation shall do all of the following:</p> <p>(1) Take into account economic and noneconomic factors, including environmental, social, health, customer impact, and technological factors; (2) Include a cost-benefit analysis, identifying total benefits and total costs; (3) Include a description of funding available to implement any planned water supply project that would provide water at a higher unit cost; (4) Include a description of the water supplier's legal authority to implement the measure and efforts to work with other relevant agencies to ensure the implementation of the measure and to share the cost of implementation</p>	10631(g)	DMMs	<p>Not Applicable. All items listed in paragraph (1) of subdivision (f) have been addressed aside from Wholesale agency programs which does not apply to LADWP</p>	Not Applicable	This checklist item not applicable to LADWP. LADWP is implementing all demand management measures listed in paragraph (1) of subdivision (f)
30	<p>(Describe) all water supply projects and water supply programs that may be undertaken by the urban water supplier to meet the total projected water use as established pursuant to subdivision (a) of Section 10635. The urban water supplier shall include a detailed description of expected future projects and programs, other than the demand management programs identified pursuant to paragraph (1) of subdivision (f), that the urban water supplier may implement to increase the amount of the water supply available to the urban water supplier in average, single-dry, and multiple-dry water years. The description shall identify specific projects and include a description of the increase in water supply that is expected to be available from each project. The description shall include an estimate with regard to the implementation timeline for each project or program.</p>	10631(h)	System Supplies	<p>p 98-101 (E-xhibits 4L, 4M, 4N, 4O, 4P)</p>	26	
31	<p>Describe the opportunities for development of desalinated water, including, but not limited to, ocean water, brackish water, and groundwater, as a long-term supply.</p>	10631(i)	System Supplies	<p>p 20 &amp; 199</p>	10 (Not Applicable)	
32	<p>Include the annual reports submitted to meet the Section 6.2 requirement (of the MOU), if a member of the CUWCC and signer of the December 10, 2008 MOU.</p>	10631(j)	DMMs	<p>Appendix H</p>	Not Applicable	<p>Since the CUWCC BMP Reporting Database is not available at this time, LADWP has attached the CUWCC BMP Reports from 2007-2008 which shows LADWP has met all the BMP coverage requirements. In addition, LADWP has submitted the necessary documentation to comply with the DMMs.</p>
33	<p>Urban water suppliers that rely upon a wholesale agency for a source of water shall provide the wholesale agency with water use projections from that agency for that source of water in five-year increments to 20 years or as far as data is available. The wholesale agency shall provide information to the urban water supplier for inclusion in the urban water supplier's plan that identifies and quantifies, to the extent practicable, the existing and planned sources of water as required by subdivision (b), available from the wholesale agency to the urban water supplier over the same five-year increments, and during various water-year types in accordance with subdivision (c). An urban water supplier may rely upon water supply information provided by the wholesale agency in fulfilling the plan informational requirements of subdivisions (b) and (c).</p>	10631(k)	System Supplies	<p>p 226 (Exhibit 11B), p 229-235 (E-xhibits 11E to 11K), p 238 (Exhibit 11L)</p>	12, 17, 29, 31	<p>Average year, single dry year, multiple dry years for 2015, 2020, 2025, and 2030.</p>

## 2010 UWMP Checklist

No.	UWMP Requirements	CA Water Code Reference	Subject	UWMP Location	UWMP Guidebook Standardized Table Locations	Additional Clarification
34	The water use projections required by Section 10631 shall include projected water use for single-family and multifamily residential housing needed for lower income households, as defined in Section 50079.5 of the Health and Safety Code, as identified in the housing element of any city, county, or city and county in the service area of the supplier.	10631.1(a)	System Demands	p 46 (Exhibit 2L)	8	
35	Stages of action to be undertaken by the urban water supplier in response to water supply shortages, including up to a 50 percent reduction in water supply, and an outline of specific water supply conditions which are applicable to each stage.	10632(a)(1)	Water Supply Reliability	p 236-238 (Sec 11.3.1)	35	
36	Provide an estimate of the minimum water supply available during each of the next three water years based on the driest three-year historic sequence for the agency's water supply.	10632(a)(2)	Water Supply Reliability	p 238-239 (Sec 11.3.2)	31	
37	(Identify) actions to be undertaken by the urban water supplier to prepare for, and implement during, a catastrophic interruption of water supplies including, but not limited to, a regional power outage, an earthquake, or other disaster.	10632(a)(3)	Water Supply Reliability	p 239-240 (Sec 11.3.3)	Not Applicable	
38	(Identify) additional, mandatory prohibitions against specific water use practices during water shortages, including, but not limited to, prohibiting the use of potable water for street cleaning.	10632(a)(4)	Water Supply Reliability	p 240-242 (Sec 11.3.4)	36	
39	(Specify) consumption reduction methods in the most restrictive stages. Each urban water supplier may use any type of consumption reduction methods in its water shortage contingency analysis that would reduce water use, are appropriate for its area, and have the ability to achieve a water use reduction consistent with up to a 50 percent reduction in water supply	10632(a)(5)	Water Supply Reliability	p 242-243 (Sec 11.3.5)	37	
40	(Indicated) penalties or charges for excessive use, where applicable.	10632(a)(6)	Water Supply Reliability	p 243 (Sec 11.3.6)	38	
41	An analysis of the impacts of each of the actions and conditions described in subdivisions (a) to (f), inclusive, on the revenues and expenditures of the urban water supplier, and proposed measures to overcome those impacts, such as the development of reserves and rate adjustments.	10632(a)(7)	Water Supply Reliability	p 244 (Sec 11.3.7)	Not Applicable	
42	(Provide) a draft water shortage contingency resolution or ordinance.	10632(a)(8)	Water Supply Reliability	p 244-245 (Sec 11.3.8) & Appendix I	Not Applicable	
43	(Indicate) a mechanism for determining actual reductions in water use pursuant to the urban water shortage contingency analysis.	10632(a)(9)	Water Supply Reliability	p 41-42 (Sec 2.2, Exhibits 2E & 2F), p 245-246 (Sec 11.3.9)	Not Applicable	
44	Provide, to the extent available, information on recycled water and its potential for use as a water source in the service area of the urban water supplier. The preparation of the plan shall be coordinated with local water, wastewater, groundwater, and planning agencies that operate within the supplier's service area	10633	System Supplies	p 14-15, p 81-82	16, 21	
45	(Describe) the wastewater collection and treatment systems in the supplier's service area, including a quantification of the amount of wastewater collected and treated and the methods of wastewater disposal.	10633(a)	System Supplies	p 88-91 (Sec 4-2, Exhibit 4D)	21	
46	(Describe) the quantity of treated wastewater that meets recycled water standards, is being discharged, and is otherwise available for use in a recycled water project.	10633(b)	System Supplies	p 88-91 (Sec 4-2, Exhibits 4C & 4D)	21, 22	

## 2010 UWMP Checklist

No.	UWMP Requirements	CA Water Code Reference	Subject	UWMP Location	UWMP Guidebook Standardized Table Locations	Additional Clarification
47	(Describe) the recycled water currently being used in the supplier's service area, including, but not limited to, the type, place, and quantity of use.	10633(c)	System Supplies	p 92-97 (Sec 4.3, Exhibits 4E - 4J)	24	
48	(Describe and quantify) the potential uses of recycled water, including, but not limited to, agricultural irrigation, landscape irrigation, wildlife habitat enhancement, wetlands, industrial reuse, groundwater recharge, indirect potable reuse, and other appropriate uses, and a determination with regard to the technical and economic feasibility of serving those uses	10633(d)	System Supplies	p 97-105 (Sec 4.4.1 to 4.4.4, Exhibits 4K-4Q)	23	
49	(Describe) The projected use of recycled water within the supplier's service area at the end of 5, 10, 15, and 20 years, and a description of the actual use of recycled water in comparison to uses previously projected pursuant to this subdivision.	10633(e)	System Supplies	p 97-98 (Sec 4.4, Exhibit 4L), p 96-97 (Sec 4.3.5, Exhibit 4J)	24, 25	
50	(Describe the) actions, including financial incentives, which may be taken to encourage the use of recycled water, and the projected results of these actions in terms of acre-feet of recycled water used per year.	10633(f)	System Supplies	p 105-106 (Sec 4.4.6)	25	
51	(Provide a) plan for optimizing the use of recycled water in the supplier's service area, including actions to facilitate the installation of dual distribution systems, to promote recirculating uses, to facilitate the increased use of treated wastewater that meets recycled water standards, and to overcome any obstacles to achieving that increased use	10633(g)	System Supplies	p 97-107 (Sec 4.4)	26	
52	The plan shall include information, to the extent practicable, relating to the quality of existing sources of water available to the supplier over the same five-year increments as described in subdivision (a) of Section 10631, and the manner in which water quality affects water management strategies and supply reliability	10634	Water Supply Reliability	p 20-22	30	For years 2015, 2020, 2025, 2030, and 2035 (changed this from 2010, 2015,...)
53	Every urban water supplier shall include, as part of its urban water management plan, an assessment of the reliability of its water service to its customers during normal, dry, and multiple dry water years. This water supply and demand assessment shall compare the total water supply sources available to the water supplier with the total projected water use over the next 20 years, in five-year increments, for a normal water year, a single dry water year, and multiple dry water years. The water service reliability assessment shall be based upon the information compiled pursuant to Section 10631, including available data from state, regional, or local agency population projections within the service area of the urban water supplier.	10635(e)	Water Supply Reliability	p 229-235 (Exhibits 1E to 1K)	32, 33, 34	
54	The urban water supplier shall provide that portion of its urban water management plan prepared pursuant to this article to any city or county within which it provides water supplies no later than 60 days after the submission of its urban water management plan	10635(b)	Plan Preparation	Appendix D	Not Applicable	
55	Each urban water supplier shall encourage the active involvement of diverse social, cultural, and economic elements of the population within the service area prior to and during the preparation of the plan.	10642	Plan Preparation	Appendix D	Not Applicable	



## 2010 UWMP Checklist

No.	UWMP Requirements	CA Water Code Reference	Subject	UWMP Location	UWMP Guidebook Standardized Table Locations	Additional Clarification
56	Prior to adopting a plan, the urban water supplier shall make the plan available for public inspection and shall hold a public hearing thereon. Prior to the hearing, notice of the time and place of hearing shall be published within the jurisdiction of the publicly owned water supplier pursuant to Section 6066 of the Government Code. The urban water supplier shall provide notice of the time and place of hearing to any city or county within which the supplier provides water supplies. A privately owned water supplier shall provide an equivalent notice within its service area.	10642	Plan Preparation	Appendix D	Not Applicable	
57	After the hearing, the plan shall be adopted as prepared or as modified after the hearing.	10642	Plan Preparation	Adoption resolution included within cover page	Not Applicable	
58	An urban water supplier shall implement its plan adopted pursuant to this chapter in accordance with the schedule set forth in its plan.	10643	Plan Preparation	p 2-3	Not Applicable	
59	An urban water supplier shall submit to the department, the California State Library, and any city or county within which the supplier provides water supplies a copy of its plan no later than 30 days after adoption. Copies of amendments or changes to the plans shall be submitted to the department, the California State Library, and any city or county within which the supplier provides water supplies within 30 days after adoption.	10644(a)	Plan Preparation	To be enclosed with transmittal letter to DWR.	Not Applicable	
60	Not later than 30 days after filing a copy of its plan with the department, the urban water supplier and the department shall make the plan available for public review during normal business hours.	10645	Plan Preparation	To be enclosed with transmittal letter to DWR.	Not Applicable	



Coordinating Agencies <sup>1,2</sup>	Participated in developing the plan	Commented on the draft	Attended public meetings	Was contacted for assistance	Was sent a copy of the draft plan	Was sent a notice of intention to adopt	Not involved / No information
Department of Water Resources				X	X		
Metropolitan Water District				X		X	
Tree People	X	X	X	X	X	X	
City of Los Angeles Dept. of Planning	X			X			
City of Los Angeles Department of Public Works, Bureau of Sanitation				X			
Upper Los Angeles River Area (ULARA) Watermaster			X				
Los Angeles County Department of Public Works Flood Control District			X				
San Gabriel Rivers Watershed Council			X				X
Safe Neighborhood Parks			X				
Panorama City Neighborhood Council			X				
West Hollywood Neighborhood Council			X				
Camp, Dresser, and McKee (CDM)	X	X	X	X	X	X	
Metropolitan Transit Authority (MTA)			X				
Forest Lawn Memorial Park			X				
Mt. Washington Association			X				
Council District 14			X				
Arroyo Seco Neighborhood Council			X				
Northridge West Neighborhood Council			X				
Greywater Corps			X				
Mar Vista Community Council			X				
Greater Cypress Park NC			X				
North East Trees			X				
Reseda Neighborhood Council			X				
LA Community Garden Council			X				
Midtown Noho Neighborhood Council			X				
River Project and Tujunga Watershed Council			X				
Encino Neighborhood Council			X				
Homeowners of Encino			X				
WaterWoman			X				
Sunland Tujunga Neighborhood Council			X				
Studio City Neighborhood Council			X				
Silverlake Reservoirs Conservancy			X				
Society of Hispanic Professional Engineers			X				
General public		X	X		X		

<sup>1</sup> Indicate the specific name of the agency with which coordination or outreach occurred.  
<sup>2</sup> Check at least one box in each row.

	2010	2015	2020	2025	2030	2035 - optional	Data source <sup>2</sup>
Service area population <sup>1</sup>	4,100,260	4,172,760	4,250,861	4,326,012	4,398,408	4,467,560	SCAG Regional Transportation Plan (2008)

<sup>1</sup> Service area population is defined as the population served by the distribution system. See Technical Methodology 2: Service Area Population (2010 UWMP Guidebook, Section M).  
<sup>2</sup> Provide the source of the population data provided.

Water use sectors	2005				
	Metered		Not metered		Total
	# of accounts	Volume	# of accounts	Volume	Volume
Single family	476,201	233,192			233,192
Multi-family	114,656	185,536			185,536
Commercial	51,428	107,414			107,414
Industrial/Governmental	10,588	62,418			62,418
Non-revenue (System Loss)		26,786			26,786
<b>Total</b>	<b>652,873</b>	<b>615,346</b>	<b>0</b>	<b>0</b>	<b>615,346</b>

Units (circle one): **acre-feet per year** million gallons per year cubic feet per year

Water use sectors	2010				
	Metered		Not metered		Total
	# of accounts	Volume	# of accounts	Volume	Volume
Single family	478,629	196,500			196,500
Multi-family	115,317	166,810			166,810
Commercial	50,017	96,675			96,675
Industrial/Governmental	10,671	52,877			52,877
Non-revenue (System Loss)		32,909			32,909
<b>Total</b>	<b>654,634</b>	<b>545,771</b>	<b>0</b>	<b>0</b>	<b>545,771</b>

Units (circle one): **acre-feet per year** million gallons per year cubic feet per year

**Table 5 (Exhibit 2J)**  
**Water deliveries — projected, 2015**

Water use sectors	2015				Total Volume
	Metered		Not metered		
	# of accounts	Volume	# of accounts	Volume	
Single family		225,699			225,699
Multi-family		178,782			178,782
Commercial		135,112			135,112
Industrial/Governmental		18,600			18,600
Non-revenue (System Loss)		41,370			41,370
<b>Total</b>	<b>0</b>	<b>599,563</b>	<b>0</b>	<b>0</b>	<b>599,563</b>

Units (circle one): **acre-feet per year** million gallons per year cubic feet per year

**Table 6 (Exhibit 2J)**  
**Water deliveries — projected, 2020**

Water use sectors	2020				Total Volume
	Metered		Not metered		
	# of accounts	Volume	# of accounts	Volume	
Single family		236,094			236,094
Multi-family		193,220			193,220
Commercial		133,597			133,597
Industrial/Governmental		16,852			16,852
Non-revenue (System Loss)		42,969			42,969
<b>Total</b>	<b>0</b>	<b>622,732</b>	<b>0</b>	<b>0</b>	<b>622,732</b>

Units (circle one): **acre-feet per year** million gallons per year cubic feet per year

**Table 7 (Exhibit 2J)**  
**Water deliveries — projected 2025, 2030, and 2035**

Water use sectors	2025		2030		2035 - optional	
	metered		metered		metered	
	# of accounts	Volume	# of accounts	Volume	# of accounts	Volume
Single family		241,180		246,879		247,655
Multi-family		202,999		213,284		218,762
Commercial		129,761		126,567		120,420
Industrial/governmental		14,708		12,634		10,513
Non-revenue (System Loss)		43,627		44,421		44,272
<b>Total</b>	<b>0</b>	<b>632,275</b>	<b>0</b>	<b>643,785</b>	<b>0</b>	<b>641,622</b>

Units (circle one): **acre-feet per year** million gallons per year cubic feet per year

**Table 8 (Exhibit 2L)**  
**Low-income projected water demands**

Low Income Water Demands <sup>1</sup>	2015	2020	2025	2030	2035 - opt
Single-family residential	11,917	12,466	12,734	13,036	13,076
Multi-family residential	23,313	25,196	26,471	27,812	28,527
<b>Total</b>	<b>35,230</b>	<b>37,662</b>	<b>39,205</b>	<b>40,848</b>	<b>41,603</b>

Units (circle one): **acre-feet per year** million gallons per year cubic feet per year  
<sup>1</sup> Provide demands either as directly estimated values or as a percent of demand.

**Table 9 - NOT APPLICABLE**  
**Sales to other water agencies**

Water distributed	2005	2010	2015	2020	2025	2030	2035 - opt
name of agency							
name of agency							
name of agency							
<b>Total</b>	<b>0</b>	<b>0</b>	<b>0</b>	<b>0</b>	<b>0</b>	<b>0</b>	<b>0</b>

Units (circle one): **acre-feet per year** million gallons per year cubic feet per year

**Table 10 - NOT APPLICABLE**  
**Additional water uses and losses**

Water use <sup>1</sup>	2005	2010	2015	2020	2025	2030	2035 -opt
Saline barriers							
Groundwater recharge							
Conjunctive use							
Raw water							
Recycled water							
System losses							
Other (define)							
<b>Total</b>	<b>0</b>	<b>0</b>	<b>0</b>	<b>0</b>	<b>0</b>	<b>0</b>	<b>0</b>

Units (circle one): **acre-feet per year** million gallons per year cubic feet per year  
<sup>1</sup> Any water accounted for in Tables 3 through 7 are not included in this table.

**Table 11 (Exhibit 2J)**  
**Total water use**

Water Use	2005	2010	2015	2020	2025	2030	2035 - opt
Total water deliveries (from Tables 3 to 7)	615,346	545,771	599,563	622,732	632,275	643,785	641,622
Sales to other water agencies (from Table 9)	-	-	-	-	-	-	-
Additional water uses and losses (from Table 10)	-	-	-	-	-	-	-
<b>Total</b>	<b>615,346</b>	<b>545,771</b>	<b>599,563</b>	<b>622,732</b>	<b>632,275</b>	<b>643,785</b>	<b>641,622</b>

Units (circle one): **acre-feet per year** million gallons per year cubic feet per year

**Table 12 (Exhibit 11E)**  
**Retail agency demand projections provided to wholesale suppliers**

Wholesaler	Contracted Volume <sup>3</sup>	2010	2015	2020	2025	2030	2035 -opt
LADWP provided LA's demand projections to MWD on Feb. 22, 2011	203,313	263,875	248,120	218,040	193,760	198,781	193,027

<sup>3</sup> Indicate the full amount of water (LADWP Purchase Order Commitment is minimum of 2,033,132.4 AF from 1/1/2003 to 1/1/2013. MWD is capable of providing more.)

Base	Parameter	Value	Units
10- to 15-year base period	2008 total water deliveries	649,822	see below
	2008 total volume of delivered recycled water	4,181	see below
	2008 recycled water as a percent of total deliveries	1	percent
	Number of years in base period <sup>1</sup>	10	years
	Year beginning base period range	1996	
5-year base period	Year ending base period range <sup>2</sup>	2005	
	Number of years in base period	5	years
	Year beginning base period range	2004	
	Year ending base period range <sup>3</sup>	2008	

Units (circle one): **acre-feet per year** million gallons per year cubic feet per year

<sup>1</sup> If the 2008 recycled water percent is less than 10 percent, then the first base period is a continuous 10-year period. If the amount of recycled water delivered in 2008 is 10 percent or greater, the first base period is a continuous 10- to 15-year period.

<sup>2</sup> The ending year must be between December 31, 2004 and December 31, 2010.

<sup>3</sup> The ending year must be between December 31, 2007 and December 31, 2010.

Base period year		Distribution System Population	Daily system gross water use (AF)	Annual daily per capita water use (gpcd)
Sequence Year	Calendar Year			
1996		3,568,651	610,144	153
1997		3,584,227	628,265	156
1998		3,613,170	587,398	145
1999		3,653,878	619,467	151
2000		3,705,600	659,121	159
2001		3,770,806	657,873	156
2002		3,829,677	667,145	156
2003		3,881,069	650,664	150
2004		3,925,129	688,213	157
2005		3,955,022	614,072	139
<b>Base Daily Per Capita Water Use<sup>1</sup></b>				<b>152</b>

<sup>1</sup> Add the values in the column and divide by the number of rows.

Base period year		Distribution System Population	Daily system gross water use (AF)	Annual daily per capita water use (gpcd)
Sequence Year	Calendar Year			
2004		3,925,129	688,213	157
2005		3,955,022	614,072	139
2006		3,986,385	626,194	140
2007		4,006,145	665,030	148
2008		4,042,085	645,641	143
<b>Base Daily Per Capita Water Use<sup>1</sup></b>				<b>145</b>

<sup>1</sup> Add the values in the column and divide by the number of rows.

Water Supply Sources		2010	2015	2020	2025	2030	2035 - opt	
Water purchased from <sup>1</sup> :	Wholesaler supplied volume (yes/no)							
	MWD Water Purchased	Yes	263,875	248,120	218,040	193,760	198,781	193,027
Supplier-produced groundwater <sup>2</sup>			76,982	40,500	96,300	111,500	111,500	110,405
Los Angeles Aqueduct			199,739	252,000	250,000	248,000	246,000	244,000
Conservation			8,178	14,180	27,260	40,340	53,419	64,368
Recycled Water - Irrigation/Industrial Use			6,703	20,000	20,400	27,000	29,000	29,000
Recycled Water - Groundwater Replenishment			0	0	0	15,000	22,500	30,000
Water Transfers			0	40,000	40,000	40,000	40,000	40,000
<b>Total</b>			<b>555,477</b>	<b>614,800</b>	<b>652,000</b>	<b>675,600</b>	<b>701,200</b>	<b>710,800</b>

Units (circle one): **acre-feet per year** million gallons per year cubic feet per year

<sup>1</sup> Volumes shown here should be what was purchased in 2010 and what is anticipated to be purchased in the future. If these numbers differ from what is contracted, show the contracted quantities in Table 17.

<sup>2</sup> Volumes shown here should be consistent with Tables 17 and 18.

Wholesale sources <sup>1,2</sup>	Contracted Volume <sup>3</sup>	2015	2020	2025	2030	2035 - opt
MWD provided LA's demand projections to LADWP on Jan. 24, 2011	203,313	397,748	413,628	414,180	417,533	418,378

<sup>1</sup> If the water supplier is a wholesaler, indicate all customers (excluding individual retail customers) to which water is sold. If the water supplier is a retailer, indicate each wholesale supplier, if more than one.

<sup>2</sup> Indicate the full amount of water (LADWP Purchase Order Commitment is minimum of 2,033,132.4 AF from 1/1/2003 to 1/1/2013. MWD is capable of providing more.)

Basin name(s)	Metered or Unmetered <sup>1</sup>	2006	2007	2008	2009	2010
San Fernando	Metered	35,486	75,640	57,060	49,106	62,218
Sylmar	Metered	1,844	3,901	4,046	576	2,998
Central	Metered	13,290	13,358	12,207	11,937	11,766
<b>Total groundwater pumped</b>		<b>50,620</b>	<b>92,899</b>	<b>73,313</b>	<b>61,619</b>	<b>76,982</b>
<b>Groundwater as a percent of total water supply</b>		<b>8.0%</b>	<b>13.8%</b>	<b>11.3%</b>	<b>10.0%</b>	<b>14.1%</b>

Units (circle one): **acre-feet per year** million gallons per year cubic feet per year

<sup>1</sup> Indicate whether volume is based on volumetric meter data or another method

Basin name(s)	2015	2020	2025	2030	2035 - opt
San Fernando	21,000	76,800	92,000	92,000	92,000
Sylmar	4,500	4,500	4,500	4,500	3,405
Central	15,000	15,000	15,000	15,000	15,000
<b>Total groundwater pumped</b>	<b>40,500</b>	<b>96,300</b>	<b>111,500</b>	<b>111,500</b>	<b>110,405</b>
<b>Percent of total water supply<sup>1</sup></b>	<b>6.7%</b>	<b>15.4%</b>	<b>17.6%</b>	<b>17.2%</b>	<b>17.1%</b>

Units (circle one): **acre-feet per year** million gallons per year cubic feet per year  
 Include future planned expansion  
<sup>1</sup> As a percentage of wet supplies excluding water conservation

Transfer agency	Transfer or exchange	Short term or long term	Proposed Volume
TBD	Transfer	Long Term	40,000
<b>Total</b>			

Units (circle one): **acre-feet per year** million gallons per year cubic feet per year

Type of Wastewater	2005 (actual)	2010 (actual)	2015	2020	2025	2030	2035 - opt
(1) Wastewater collected & treated in service area	487,296	408,044	468,432	478,308	488,408	508,015	527,621
(2) Volume that meets recycled water standard	65,018	57,171	112,391	114,163	115,586	117,627	117,694
(3) Secondary water sent to West Basin for Recycling		34,115	44,230	45,365	45,365	50,865	50,865
Calculation to match Table 22 totals below = (1) - (2) - (3)		316,758	311,811	318,781	327,457	339,523	359,062

Units (circle one): **acre-feet per year** million gallons per year cubic feet per year  
 (1) Only includes recycled water from DCT, LAG and TIWRP AWTF.  
 (3) Secondary water sent to West Basin is not included as part of LADWP recycled water.

Method of disposal	Treatment Level	2010	2015	2020	2025	2030	2035 - opt
Recycling and Pacific Ocean via Los Angeles River	Tertiary to Title 22 standards with Nitrification/Denitrification	0	0	0	0	695	3,464
Recycling and Ocean via Los Angeles River	Tertiary to Title 22 standards with Nitrification/Denitrification	0	3,027	4,932	7,062	9,192	11,322
Recycling and Outfall to Ocean	Tertiary; Advanced treatment (MF/RO)	15,694	13,004	13,228	13,564	14,125	14,573
Conveyance to WBMWD for Recycling and Ocean outfall	Full secondary	301,064	295,781	300,620	306,831	315,511	329,703
<b>Total</b>		<b>316,758</b>	<b>311,811</b>	<b>318,781</b>	<b>327,457</b>	<b>339,523</b>	<b>359,062</b>

Units (circle one): **acre-feet per year** million gallons per year cubic feet per year  
 The following water is not included: All water treated to Title 22 standards, and Secondary Water delivered to West Basin.

User type	Description	Feasibility <sup>1</sup>	2015	2020	2025	2030	2035 - opt
Agricultural irrigation			NA	NA	NA	NA	NA
Landscape irrigation <sup>2</sup>			4,220	4,220	4,220	6,135	15,135
Commercial <sup>3</sup>			165	165	165	165	165
Golf course irrigation			1,400	1,400	1,400	1,400	1,400
Wildlife habitat			26,990	26,990	26,990	26,990	26,990
Wetlands							
Industrial reuse			9,300	9,300	9,300	9,300	9,300
Groundwater recharge (GWR)			0	15,000	15,000	30,000	30,000
Seawater barrier			3,000	3,000	3,000	3,000	3,000
Geothermal/Energy			NA	NA	NA	NA	NA
Indirect potable reuse			NA	NA	NA	NA	NA
Other (user type)							
Other (user type)							
<b>Total</b>			<b>0</b>	<b>45,075</b>	<b>60,075</b>	<b>60,075</b>	<b>85,990</b>

Units (circle one): **acre-feet per year** million gallons per year cubic feet per year  
<sup>1</sup> Technical and economic feasibility.  
<sup>2</sup> Includes parks, schools, cemeteries, churches, residential, or other public facilities  
<sup>3</sup> Includes commercial building use such as landscaping, toilets, HVAC, and commercial uses (car washes, laundries, nurseries, etc)

Use type	2010 actual use	2005 Projection for 2010 <sup>1</sup>
Agricultural irrigation		
Landscape irrigation <sup>2</sup>		
Commercial <sup>3</sup>		
Golf course irrigation		
Wildlife habitat		
Wetlands		
Industrial reuse		
Groundwater recharge		
Seawater barrier		
Geothermal/Energy		
Indirect potable reuse		
Other (user type) - Municipal & Industrial Uses	6,703	16,950
Other (user type) - Environmental Uses	25,008	26,990
<b>Total</b>	<b>31,711</b>	<b>43,940</b>

Units (circle one): **acre-feet per year** million gallons per year cubic feet per year  
<sup>1</sup> From the 2005 UWMP. There has been some modification of use types. Data from the 2005 UWMP can be left in the existing categories or modified to the new categories, at the discretion of the water supplier.  
<sup>2</sup> Includes parks, schools, cemeteries, churches, residential, or other public facilities  
<sup>3</sup> Includes commercial building use such as landscaping, toilets, HVAC, etc) and commercial uses (car washes, laundries, nurseries, etc)

Actions	Projected Results					
	2010	2015	2020	2025	2030	2035 - opt
Financial incentives						
Cost savings, shared conservation of resources, environmental benefit, reliability	6,703	20,000	20,400	27,000	29,000	29,000
Sustainability (groundwater replenishment)				15,000	22,500	30,000
<b>Total</b>	<b>6,703</b>	<b>20,000</b>	<b>20,400</b>	<b>42,000</b>	<b>51,500</b>	<b>59,000</b>

Units (circle one): **acre-feet per year** million gallons per year cubic feet per year

Project name <sup>1</sup>	Projected start date	Projected completion date	Potential project constraints <sup>2</sup>	Normal-year supply <sup>3</sup>	Single-dry year supply <sup>3</sup>	Multiple-dry year first year supply <sup>3</sup>	Multiple-dry year second year supply <sup>3</sup>	Multiple-dry year third year supply <sup>3</sup>
<b>Recycling Projects</b>								
Harbor Irrigation, Commercial, Industrial	2009	2015	Funding	9520	9520	9520	9520	9520
Metro Irrigation (little Commercial, Industrial)	2009	2015	Funding	1813	1813	1813	1813	1813
Valley Irrigation (little Commercial/Industrial)	2009	2013	Funding	844	844	844	844	844
Westside Irrigation, Commercial, Industrial	2009	2015	Funding	350	350	350	350	350
Indirect Potable Reuse (Groundwater Recharge) Initial Stage	2015	2021	Funding	15000	15000	15000	15000	15000
Indirect Potable Reuse (Groundwater Recharge) 2nd Stage	2021	2035	Funding	15000	15000	15000	15000	15000
Other Municipal and Industrial Projects	2015	2035	Funding	16,473	16,473	16,473	16,473	16,473
<b>Total</b>			<b>0</b>	<b>59,000</b>	<b>59,000</b>	<b>59,000</b>	<b>59,000</b>	<b>59,000</b>

Units (circle one): **acre-feet per year** million gallons per year cubic feet per year

<sup>1</sup> Water volumes presented here should be accounted for in Table 16.  
<sup>2</sup> Indicate whether the project is likely to happen and what constraints, if any, exist for project implementation.  
<sup>3</sup> Provide estimated supply benefits, if available.

Water Year Type	Base Year(s)
Average Water Year	FY1956/57 to FY2005/06
Single-Dry Water Year	FY1990/91
Multiple-Dry Water Years - Driest 5-year sequence	FY1988/89 to FY1992/93
Multiple-Dry Water Years - Driest 3-year sequence	FY1958/59 to FY1960/61

Average / Normal Water Year	Single Dry Water Year	Multiple Dry Water Years			
		Year 1	Year 2	Year 3	Year 4
FY1956/57 to FY2005/06	FY1990/91	FY1988/89	FY1989/90	FY1990/91	FY1991/92
360,509	130,325	327,181	206,215	130,325	176,888
Percent of Average/Normal Year:	36.2%	90.8%	57.2%	36.2%	49.1%

<sup>1</sup> Showing LA Aqueduct supply reliability only. Groundwater & Recycled Water don't vary with weather. MWD supply is used to supplement insufficient local supplies and is not directly correlated to weather.

Water supply sources <sup>1</sup>	Specific source name, if any	Limitation quantification	Legal	Environmental	Water quality	Climatic	Additional information
Metropolitan Water District			x	x		x	
Supplier-produced groundwater				x	x		
Los Angeles Aqueduct			x	x		x	
Conservation						x	
Recycled Water - Irrigation/Industrial Use			x	x		x	

Units (circle one): **acre-feet per year** million gallons per year cubic feet per year

<sup>1</sup> From Table 16.

Water source	Description of condition	2010	2015	2020	2025	2030	2035 - opt
Groundwater - San Fernando Basin (See Exhibit 6G)*	Expected increased contamination issues (2015) and clean up programs expected to be completed (2021)	24,782	66,000	10,200	0	0	0

\*Yearly Quantities listed represent total amount of water LADWP is unable to pump from the SFB due to groundwater contamination. Contamination issues are resolved after completion of clean-up programs in 2021

Units (circle one): **acre-feet per year** million gallons per year cubic feet per year

Water supply sources <sup>1</sup>	Average / Normal Water Year Supply <sup>2</sup>	Multiple Dry Water Year Supply <sup>2</sup>		
		Year 2011	Year 2012	Year 2013
Los Angeles Aqueduct	254,000	104,530	50,849	59,382
Groundwater	106,500	61,090	53,660	46,260
Conservation	8,178	9,380	10,580	11,780
Recycled Water - Irrigation/Industrial Use	7,500	7,500	8,300	9,000
Recycled Water - Groundwater Replenishment	0	0	0	0
Water Transfers	0	0	0	0
MWD Water Purchases	245,522	407,500	484,811	500,078
Percent of normal year:	100.0%	94.9%	97.8%	100.8%

Units (circle one): **acre-feet per year** million gallons per year cubic feet per year

<sup>1</sup> From Table 16.  
<sup>2</sup> See Table 27 for basis of water type years.

	2015	2020	2025	2030	2035 - opt
<b>Supply totals (from Table 16)</b>	614,800	652,000	675,600	701,200	710,800
<b>Demand totals (From Table 11)</b>	599,563	622,732	632,275	643,785	641,622
<b>Difference (Conservation)</b>	15,237	29,268	43,325	57,415	69,178
Difference as % of Supply	2.5%	4.5%	6.4%	8.2%	9.7%
Difference as % of Demand	2.5%	4.7%	6.9%	8.9%	10.8%

Units are in acre-feet per year.

	2015	2020	2025	2030	2035 - opt
<b>Supply totals<sup>1,2</sup></b>	651,700	691,100	716,100	743,200	753,400
<b>Demand totals<sup>2,3,4</sup></b>	637,520	663,840	675,760	689,781	689,032
<b>Difference</b>	14,180	27,260	40,340	53,419	64,368
Difference as % of Supply	2.2%	3.9%	5.6%	7.2%	9.3%
Difference as % of Demand	2.2%	4.1%	6.0%	7.7%	9.3%

Units are in acre-feet per year.

<sup>1</sup> Consider the same sources as in Table 16. If new sources of water are planned, add a column to the table and specify the source, timing, and amount of water.

<sup>2</sup> Provide in the text of the UWMP text that discusses how single-dry-year water supply volumes were determined.

<sup>3</sup> Consider the same demands as in Table 3. If new water demands are anticipated, add a column to the table and specify the source, timing, and amount of water.

<sup>4</sup> The urban water target determined in this UWMP will be considered when developing the 2020 water demands included in this table.

	2015	2020	2025	2030	2035 - opt	
<b>Multiple-dry year first year supply</b>	<b>Supply totals<sup>1,2</sup></b>	608,200	661,200	694,500	720,100	740,300
	<b>Demand totals<sup>2,3,4</sup></b>	597,620	641,790	662,010	674,530	682,500
	<b>Difference</b>	10,580	19,410	32,490	45,570	57,800
	Difference as % of Supply	1.7%	2.9%	4.7%	6.3%	7.8%
	Difference as % of Demand	1.8%	3.0%	4.9%	6.8%	8.5%
<b>Multiple-dry year second year supply</b>	<b>Supply totals<sup>1,2</sup></b>	626,500	675,400	706,100	732,400	749,300
	<b>Demand totals<sup>2,3,4</sup></b>	614,720	653,370	670,990	684,210	689,300
	<b>Difference</b>	11,780	22,030	35,110	48,190	60,000
	Difference as % of Supply	1.9%	3.3%	5.0%	6.6%	8.0%
	Difference as % of Demand	1.9%	3.4%	5.2%	7.0%	8.7%
<b>Multiple-dry year third year supply</b>	<b>Supply totals<sup>1,2</sup></b>	602,900	644,600	670,900	696,100	708,800
	<b>Demand totals<sup>2,3,4</sup></b>	589,920	619,960	633,180	645,300	646,600
	<b>Difference</b>	12,980	24,640	37,720	50,800	62,200
	Difference as % of Supply	2.2%	3.8%	5.6%	7.3%	8.8%
	Difference as % of Demand	2.2%	4.0%	6.0%	7.9%	9.6%

Units are in acre-feet per year.

<sup>1</sup> Consider the same sources as in Table 16. If new sources of water are planned, add a column to the table and specify the source, timing, and amount of water.

<sup>2</sup> Provide in the text of the UWMP text that discusses how single-dry-year water supply volumes were determined.

<sup>3</sup> Consider the same demands as in Table 3. If new water demands are anticipated, add a column to the table and specify the source, timing, and amount of water.

<sup>4</sup> The urban water target determined in this UWMP will be considered when developing the 2020 water demands included in this table.

Stage No.	Water Supply Conditions	% Shortage
Phase I	No Shortage	0%
Phase II	Moderate Shortage	> 0 to 15%
Phase III	Severe Shortage	15 to 20%
Phase IV	Critical Shortage	20 to 35%
Phase V	Super Critical Shortage	35 to 50%

<sup>1</sup> One of the stages of action must be designed to address a 50 percent reduction in water supply.



Table 36 (Section 11.3.4) Water shortage contingency — mandatory prohibitions	
Examples of Prohibitions	Stage When Prohibition Becomes Mandatory
Using potable water for washing paved surfaces	Phase I
Using water to clean, fill, or maintain levels in decorative fountains, ponds, lakes, or similar structures for aesthetic purposes	Phase I
Any public place where food is sold, served, or offered for sale should not serve water unless requested.	Phase I
No customer should permit water to leak from any pipe or fixture on customer's premises	Phase I
No customer shall wash a vehicle with a hose that does not have a self-closing water shut-off device	Phase I
No customer shall irrigate during periods of rain	Phase I
No customer shall irrigate between the hours of 9:00 a.m. and 4:00 p.m.	Phase I
Irrigating of landscape with potable water using spray head sprinklers and bubblers shall be limited to no more than ten minutes per watering station per day	Phase I
No customer shall irrigate in a manner that causes excess or continuous flow or runoff onto an adjoining sidewalk, driveway, street, gutter, or ditch	Phase I
No installation of single pass cooling systems shall be permitted in buildings requesting new water service.	Phase I
No installation of single pass cooling systems shall be permitted in new conveyor car wash and new commercial laundry systems	Phase I
Operators of hotels and motels provide guests with the option of choosing not to have towels and linens laundered daily	Phase I
No large landscape shall have irrigation systems without rain sensors that shut-off the irrigation systems	Phase I
No landscape irrigation shall be permitted on any day other than Monday, Wednesday, or Friday for odd-numbered street addresses and Tuesday, Thursday, or Sunday for even-numbered street addresses. Street addresses ending in ½ or any fraction shall conform to the permitted uses for the last whole number in the address. Watering times shall be limited to: (a) Non-conserving nozzles (spray head sprinklers and bubblers) – no more than eight minutes per watering day per station for a total of 24 minutes per week; (b) Conserving nozzles (standard rotors and multi-stream rotary heads) – no more than 15 minutes per cycle and up to two cycles per watering day per station for a total of 90 minutes per week.	Phase II
No landscape irrigation shall be permitted on any day other than Monday for odd-numbered street addresses and Tuesday for even-numbered street addresses. Street addresses ending in ½ or any fraction shall conform to the permitted uses for the last whole number in the address.	Phase III
No washing of vehicles allowed except at commercial car wash facilities.	Phase III
No filling of residential swimming pools and spas with potable water.	Phase III

Table 37 (Section 11.3.5) Water shortage contingency — consumption reduction methods		
Consumption Reduction Methods	Stage When Method Takes Effect	Projected Reduction (%)
LADWP's existing rate structure (enacted in 1993) serves as a basis for further reducing consumption. First tier water allotments are reduced during shortages by the degree of the shortage. For single-family residential users, the adjusted first tier allotments apply for the entire year. For other users, the adjusted first tier allotments apply only during the high season (June 1 through October 31). Details of LADWP's water rate structure are provided in Appendix C – Water Rate Ordinance.	During a water shortage or emergency condition	Up to 25%
Emergency Water Conservation Plan (UWMP Section 11.3.1)	Phase I is permanent with higher phases activated during a water shortage or emergency condition	Up to 50%
Water conservation public service announcements (through television and/or radio), billboard ads, flyer distributions, and conservation workshops. Participation in public exhibits to disseminate water conservation information within its service area. Conservation is a permanent and long-term application used within the City to counter the potentially adverse impacts of water supply shortages.	During a water shortage or emergency condition	
Water will be allocated to meet needs for domestic use, sanitation, fire protection, and other priorities. This will be done equitably and without discrimination between customers using water for the same purpose(s).	extreme water shortage conditions	

Table 38 (Section 11.3.6) Water shortage contingency — penalties and charges		
Penalties or Charges	Stage When Penalty Takes Effect	
Written Warning	First violation	For water meters smaller than two inches
Surcharge in the amount of \$100	Second violation within preceding 12-month period	
Surcharge in the amount of \$200	Third violation within preceding 12-month period	
Surcharge in the amount of \$300	Fourth violation within preceding 12-month period	
LADWP may install a flow-restricting device of 1 gpm capacity for services up to 1 1/2 inches in size and comparatively sized restrictors for larger services or terminate a customer's service, in addition to aforementioned financial surcharges	Fifth violation or subsequent violation within preceding 12-month period	
Written Warning	First violation	For water meters two inches and larger
Surcharge in the amount of \$200	Second violation within preceding 12-month period	
Surcharge in the amount of \$400	Third violation within preceding 12-month period	
Surcharge in the amount of \$600	Fourth violation within preceding 12-month period	
LADWP may install a flow-restricting device or terminate a customer's service, in addition to aforementioned financial surcharges	Fifth violation or subsequent violation within preceding 12-month period	

## **Water Rate Ordinance**



---

# Los Angeles

# Water Rates

**June 1, 1995**

Amended July 28, 1997,  
February 4, 2000, June 20, 2004,  
November 27, 2006, and June 19, 2008

---



---

Los Angeles Department of Water and Power

**Ordinance No. 170435**

As Amended by Ordinance No. 171639, Ordinance No. 173017,  
Ordinance No. 175964, Ordinance No. 177968  
and Ordinance No. 179802

---

## TABLE OF CONTENTS

### RATE SCHEDULES

#### Section 2

<u>Rate Schedule</u>	<u>Schedule Title</u>	<u>Page No.</u>
A	Single-Dwelling Unit Residential Customers .....	1
B	Multi-Dwelling Unit Residential Customers .....	4
C	Commercial ,Industrial and Governmental Customers and Temporary Construction .....	6
D	Reclaimed Water Service .....	8
E	Private Fire Service .....	10
F	Publicly-Sponsored Irrigation; Recreational; Agricultural, Horticultural, and Floricultural Uses; Community Gardens and Youth Sports .....	12

### GENERAL PROVISIONS

#### Section 3

<u>Provision</u>	<u>Page No.</u>
A. Rate Applicability and Rules .....	16
B. Surplus Water - Paramount Right of the City of Los Angeles .....	16
C. Metering .....	16
D. Minimum Charge .....	16
E. Time and Manner of Payment of Bills .....	17
F. Water Procurement Adjustment .....	17
G. Water Quality Improvement Adjustment .....	19
H. Water Revenue Adjustment .....	20
I. Water Security Adjustment .....	22
J. Adjustment Factor Limitations .....	23
K. Owens Valley Regulatory Adjustment .....	23
L. Low-Income Subsidy Adjustment .....	24
M. Large Irrigated Turf .....	25
N. Seasonal Variation Adjustments .....	26
O. Lifeline Customer Subsidy .....	26
P. Low-Income Subsidy .....	26
Q. Household Size .....	27
R. Shortage Year Rates .....	28
S. Resale of Water and Submetered Customers .....	35
T. Definitions.....	36

## **R. SHORTAGE YEAR RATES**

When the Board of Water and Power Commissioners, by resolution, finds and determines that the water supply available to the City of Los Angeles is insufficient to meet the City's normal water demand, it shall determine the degree of shortage and apply the corresponding commodity charges stated below, instead of the otherwise applicable commodity charges.

Certified copies of such resolution shall be transmitted to the offices of the Mayor, City Clerk, and the Council. At any time within such period as may be specified by resolution, which shall not be less than fifteen days after delivery of such certified copies to said offices, the Mayor, in writing, or the Council, by majority vote, may disapprove such resolution. If neither the Mayor nor the Council disapprove on said resolution within the period so specified, the same shall take effect upon the expiration of said period and shall be applicable to charges commencing on the first day of the billing cycle after the expiration of the period prescribed in the resolution. If the Mayor shall disapprove said resolution within said period, he shall forthwith advise the Council and the Board, in writing, of such disapproval. The Council shall thereupon consider such disapproval in the same manner as upon the reconsideration of an ordinance notwithstanding the veto of the Mayor, and if upon such consideration the Council shall, by the votes of two-thirds of the whole Council, determine that the Mayor's disapproval should be overruled, such disapproval by the Mayor shall be of no effect, and the said resolution of the Board shall forthwith take effect and shall be applicable to charges commencing on the first day of the billing cycle after the action by the Council overruling the Mayor's disapproval and the expiration of the period prescribed in the resolution.

The following commodity rates shall be substituted into the appropriate corresponding schedule and shall continue during the time that a water shortage determined by the Board of Water and Power Commissioners remains in effect.

1. Schedule A - Single-Dwelling Unit Residential Customers
  - a. The first tier usage block shall be reduced by the degree of the shortage and shall be billed at the rate specified in Section 2.A.3.a.
  - b. Second Tier Usage  
Usage above the first tier usage block as prescribed in Section 3.R.1.a above shall be billed as follows:

Commodity Charge Rate Per  
Hundred Cubic Feet

10% Shortage

Low Season - November 1 through May 31  
1.201 times the High Season rate specified in  
Section 2.A.3.b, rounded to the nearest penny

High Season - June 1 through October 31  
1.201 times the High Season rate specified in  
Section 2.A.3.b, rounded to the nearest penny

15% Shortage

Low Season - November 1 through May 31  
1.442 times the High Season rate specified in  
Section 2.A.3.b, rounded to the nearest penny

High Season - June 1 through October 31  
1.442 times the High Season rate specified in  
Section 2.A.3.b, rounded to the nearest penny

20% Shortage

Low Season - November 1 through May 31  
1.682 times the High Season rate specified in  
Section 2.A.3.b, rounded to the nearest penny

High Season - June 1 through October 31  
1.682 times the High Season rate specified in  
Section 2.A.3.b, rounded to the nearest penny

25% Shortage

Low Season - November 1 through May 31  
1.964 times the High Season rate specified in  
Section 2.A.3.b, rounded to the nearest penny

High Season - June 1 through May 31  
1.964 times the High Season rate specified in  
Section 2.A.3.b, rounded to the nearest penny



2. Schedule B - Multi-Dwelling Unit Residential Customers

Commodity Charge	Rate Per <u>Hundred Cubic Feet</u>
------------------	---------------------------------------

10% Shortage

- a. Up to 115% of Adjusted First Tier Usage Block shall be billed at the rate specified in Section 2.B.3.a.
- b. Usage above 115% of Adjusted First Tier Usage Block shall be billed at 1.201 times the High Season rate specified in Section 2.B.3.b, rounded to the nearest penny.

15% Shortage

- c. Up to 115% of Adjusted First Tier Usage Block shall be billed at the rate specified in Section 2.B.3.a.
- d. Usage above 115% of First Tier Usage Block shall be billed at 1.442 times the High Season rate specified in Section 2.B.3.b, rounded to the nearest penny.

20% Shortage

- e. Up to 110% of Adjusted First Tier Usage Block shall be billed at the rate specified in Section 2.B.3.a.
- f. Usage above 110% of Adjusted First Tier Usage Block shall be billed at 1.682 times the High Season rate specified in Section 2.B.3.b, rounded to the nearest penny.

25% Shortage

- g. Up to 110% of Adjusted First Tier Usage Block shall be billed at the rate specified in Section 2.B.3.a.
- h. Usage above 110% of Adjusted First Tier Usage Block shall be billed at 1.964 times the High Season rate specified in Section 2.B.3.b, rounded to the nearest penny.

3. Schedule C – Commercial and Industrial Customers

Commodity Charge	Rate Per <u>Hundred Cubic Feet</u>
------------------	---------------------------------------

10% Shortage

- a. Up to 115% of Adjusted First Tier Usage Block shall be billed at the rate specified in Section 2.C.3.a.
- b. Usage above 115% of Adjusted First Tier Usage Block shall be billed at 1.201 times the High Season rate specified in Section 2.C.3.b, rounded to the nearest penny.

15% Shortage

- c. Up to 115% of Adjusted First Tier Usage Block shall be billed at the rate specified Section 2.C.3.a.
- d. Usage above 115% of Adjusted First Tier Usage Block shall be billed at 1.442 times the High Season rate specified in Section 2.C.3.b, rounded to the nearest penny.

20% Shortage

- e. Up to 110% of Adjusted First Tier Usage Block shall be billed at the rate specified Section 2.C.3.a.
- f. Usage above 110% of Adjusted First Tier Usage Block shall be billed at 1.682 times the High Season rate specified in Section 2.C.3.b, rounded to the nearest penny.

25% Shortage

- g. Up to 110% of Adjusted First Tier Usage Block shall be billed at the rate specified Section 2.C.3.a.

- h. Usage above 110% of Adjusted First Tier Usage Block shall be billed at 1.964 times the High Season rate specified in Section 2.C.3.b, rounded to the nearest penny.
4. Schedule F - Publicly-Sponsored Irrigation; Recreational; Agricultural, Horticultural, and Floricultural Uses; Community Gardens and Youth Sports

<u>Commodity Charges</u>	<u>Rate Per Hundred Cubic Feet</u>
<u>10% Shortage</u>	

- a. First Tier Usage Block shall be billed at the rate specified in Section 2.F.3.a.

Monthly first tier usage blocks shall be established by the Department for domestic water use, landscape and large area irrigation after an audit has been completed, considering site conditions and based upon best management practices approved by the Board of Water and Power Commissioners, and shall be subject to periodic review and revision by the Department.

- b. Second Tier Usage

Usage above the first tier usage block as prescribed in Section 3.R.4.a above shall be billed at 1.201 times the High Season rate specified in Section 2.F.3.c, rounded to the nearest penny.

15% Shortage

- c. First Tier Usage Block shall be billed at the rate specified in Section 2.F.3.a.

Monthly first tier usage blocks shall be established by the Department for domestic water use, landscape and large area irrigation after an audit has been completed, considering site conditions and based upon best management practices approved by the Board of Water and Power Commissioners, and shall be subject to periodic review and revision by the Department.

d. Second Tier Usage

Usage above the first tier usage block as prescribed in Section 3.R.4.c above shall be billed at 1.442 times the High Season rate specified in Section 2.F.3.c, rounded to the nearest penny.

20% Shortage

- e. First Tier Usage Block shall be billed at the rate specified in Section 2.F.3.a.

Monthly first tier usage blocks shall be established by the Department for domestic water use, landscape and large area irrigation after an audit has been completed, considering site conditions and based upon best management practices approved by the Board of Water and Power Commissioners, and shall be subject to periodic review and revision by the Department.

f. Second Tier Usage

Usage above the first tier usage block as prescribed in Section 3.R.4.e above shall be billed at 1.682 times the High Season rate specified in Section 2.F.3.c, rounded to the nearest penny.

25% Shortage

- g. First Tier Usage Block shall be billed at the rate specified in Section 2.F.3.a.

Monthly first tier usage blocks shall be established by the Department for domestic water use, landscape and large area irrigation after an audit has been completed, considering site conditions and based upon best management practices approved by the Board of Water and Power Commissioners, and shall be subject to periodic review and revision by the Department.

h. Second Tier Usage

Usage above the first tier usage block as prescribed in Section 3.R.4.g above shall be billed at 1.964 times the High Season rate specified in Section 2.F.3.c, rounded to the nearest penny.

5. Adjustments and credits pursuant to General Provisions F, G, H, I, K, L, O and P shall be applied to the commodity charges set forth in this General Provision R in the same manner that they apply to the commodity charge set forth in Rate Schedules A, B, C, D, E, and F, inclusive.
6. The Adjusted First Tier Usage Block shall be each customer's maximum December through March average consumption for the three winter periods preceding the declared water shortage event reduced by the degree of water shortage, except that the minimum adjusted first tier usage for Schedule B customers only shall be twenty-eight (28) hundred cubic feet per month reduced by the degree of water shortage and the minimum adjusted first tier usage for Schedule C customers shall be one one-hundred cubic feet per month.

Each customer's December through March average consumption that is applied at the beginning of each declared water shortage event shall continue to be applied during the time that a water shortage determined by the Board of Water and Power Commissioners remains in effect.

7. Those Schedules B and C customers that are found to not have established an Adjusted First Tier Usage Block based on prior usage may have an adjusted first tier usage block computation made by the Department that is based on the customer's water use characteristics, site conditions, and all applicable best management practices for conservation approved by the Board of Water and Power Commissioners.
8. Application of this General Provision R shall be subject to rules and regulations adopted by the Board of Water and Power Commissioners.
9. When the Board of Water and Power Commissioners determines that the water supply available to the City of Los Angeles is either sufficient, or if not sufficient, is better able to meet the City's normal water supply, it shall, by resolution, either terminate the implementation of these shortage year rates or determine the lesser degree of shortage and apply the applicable commodity charges stated above instead of the commodity charges theretofore implemented pursuant to this Provision R. Such determination shall become effective upon publication of the resolution.



## **Notice of Meeting and Public Comments**





# **PUBLIC NOTICES**

## Public Notification

An extensive outreach campaign was conducted for the 2010 update of the LADWP Urban Water Management Plan (UWMP). As shown in the following table, a total of four workshops were conducted, seeking public input on the 2010 update. The first two workshops were held in January 2010 and were intended to receive input concurrent with the preparation of the 2010 UWMP draft. The third and fourth workshops were conducted in February 2011. These workshops were intended to present the 2010 draft UWMP and usher in the beginning of a 60 day period during which comments could be submitted. Comments were collected by LADWP and are shown in a separate section in the pages that follow.

Event	Date	Time	Location	Attendees
Workshop 1 (2010)	1/12/10	6:00 p.m.	Marvin Braude Constituent Center	23
Workshop 2 (2010)	1/20/10	5:00 p.m.	Los Angeles River Center	18
Workshop 1 (2011)	2/3/11	6:00 p.m.	LADWP Van Nuys Service Center	30
Workshop 2 (2011)	2/9/11	6:00 p.m.	LADWP John Ferraro Building, Downtown Los Angeles	44
Final Public Hearing for LADWP Board Adoption	5/3/11	1:30 p.m.	LADWP John Ferraro Building, Downtown Los Angeles	NA

Following incorporation of comments and the production of a finalized version, the UWMP was adopted by the LADWP Board of Commissioners on May 3, 2011.

### E-mail Notification

For notification of both rounds of workshops, a flyer was e-mailed to all City of Los Angeles neighborhood councils, homeowners organizations, and stakeholders. The flyer announcement is shown in the pages that follow.

### Media Publications

For the February 2011 workshops, an announcement (see next pages) was published in the publications listed in the following table on the dates indicated. As shown, the announcement was also translated and included in multiple foreign language publications. Three example foreign language ads are included in the pages that follow.

Media Outlet	Run date(s)
<i>Wave/Independent/Equal Access Media</i>	Thursday 1/27
<i>Eastern Group Publications</i>	Thursday 1/27
<i>LA Watts Times</i>	Thursday 1/27
<i>LA Sentinel</i>	Thursday 1/27
<i>Korean Daily</i>	Friday 1/28

<i>Downtown News</i>	Monday 1/24
<i>Philippine Media (formally California Examiner)</i> Filipino weekly (English language)	Thursday 1/27
<i>La Opinion</i> (Spanish)	Friday 1/28
<i>Our Weekly Newspaper</i>	Thursday 1/27
<i>Palisadian Post</i>	Thursday 1/27
<i>Beverly Press/Park LaBrea News</i>	Thursday 1/27
<i>Tolucan Times-Wed.</i>	Wednesday 1/26
<i>Korean Times</i>	Friday 1/28
<i>Daily Breeze</i>	Friday 1/28
<i>Daily News</i>	Friday 1/28
<i>LA Business Journal</i>	Monday 1/24
<i>SF Valley Business Journal</i>	Monday 1/24
<i>Sing Tao (Chinese)</i>	Friday 1/28
<i>CityWatch Web Site</i>	On-going to 2/9

### **Website Posting**

The flyer notifications for both rounds of workshops and comments/responses from the January 2010 workshops were posted on the LADWP website [www.ladwp.com](http://www.ladwp.com). In addition, the workshop notification was posted on several other websites, including LADWPNews, Twitter, facebook, and neighborhood council web pages. Examples are included in the pages that follow.

### **60-Day Notification**

60-days prior to LADWP Board adoption, the County of Los Angeles, and the Cities of Culver City and West Hollywood were notified (via e-mail and regular mail) of the anticipated adoption of the 2010 UWMP. In addition, the following publications were used for Notification of Board adoption on the dates specified. Letters and ads are shown in the pages that follow.

<b>Media Outlet</b>	<b>Run date(s)</b>
<i>Metropolitan News</i>	Thursday 3/3/11 and 3/10/11
<i>La Opinion</i>	

---

**From:** Repp, Chris  
**Sent:** Wednesday, December 22, 2010 11:26 AM  
**Subject:** Urban Water Management Plan (UWMP) Workshops Rescheduled  
**Attachments:** UWMP Workshop Rev 12.22.10.pdf

The workshops originally scheduled for January 13, and January 18, 2011 have been postponed to the following dates, times, and locations. We apologize for any inconvenience.

Thursday, February 3, 2011  
6:00 p.m.

**VAN NUYS**

Van Nuys Service Center  
14401 Saticoy Street

Wednesday, February 9, 2011  
6:00 p.m.

**DOWNTOWN L.A.**

LADWP John Ferraro Building, Cafeteria Conference Room  
111 N. Hope St.

Free Parking will be provided. The draft 2010 UWMP will be available for review after January 13, 2011 at <http://www.ladwp.com>.

For more information, contact Simon Hsu at (213) 367-2970.

See attached (revised) flyer.

---

**From:** Repp, Chris  
**Sent:** Tuesday, December 14, 2010 8:26 AM  
**Subject:** LADWP's Draft 2010 Urban Water Management Plan Workshops

The public is invited to hear an overview of the LADWP Water System's strategic priorities and preview the draft 2010 Urban Water Management Plan (UWMP) that will outline the City's long-term water resources management strategy. The UWMP is the City's master plan for water supply and resources management. All large California urban water agencies prepare a UWMP and provide an update to their plan every five years.

Please join us at one of the following workshops:

**Thursday, January 13 – 5:00 p.m.**

**CYPRESS PARK**

Los Angeles River Center Los Feliz Room  
570 West Avenue 26

**Tuesday, January 18 – 5:00 p.m.**

**VAN NUYS**

Van Nuys Service Center  
7501 Tyrone Avenue

**The draft 2010 UWMP will be available for review after January 13, 2011 at**

<http://www.ladwp.com>.

For more information, contact Simon Hsu at (213) 367-2970.

*See attached flyer.*

# YOU ARE INVITED!

Please join the Los Angeles Department of Water and Power (LADWP) at a public workshop to share your views regarding Los Angeles' water supply as the City prepares it's

## 2010 Urban Water Management Plan

We would appreciate your thoughts and will be seeking your input on various topics and questions such as:

- What water resource options should LADWP pursue to meet future needs?
- What water management strategies should LADWP consider?
- How should LADWP manage water supplies during times of shortage?

---

**TUESDAY, JANUARY 12, 6:00 P.M.**

VAN NUYS

Marvin Braude Constituent Center  
6262 Van Nuys Blvd.

**WEDNESDAY, JANUARY 20, 5:00 P.M.**

CYPRESS PARK

Los Angeles River Center - Los Feliz Room  
570 West Avenue 26

---

Presentation to be followed by a group discussion. Light refreshments will be provided.

The City of Los Angeles 2005 Urban Water Management Plan is available on LADWP's web site at: <http://www.ladwp.com/ladwp/cms/ladwp001354.jsp>

**For more information, please contact  
Simon Hsu at (213) 367-2970, or [simon.hsu@ladwp.com](mailto:simon.hsu@ladwp.com)**

**About LADWP's Urban Water Management Plan (UWMP):**

All large California urban water agencies prepare a UWMP and provide an update every five years. LADWP's UWMP offers a detailed discussion on the status of Los Angeles' imported water sources, and provides an update of future water supply and demand for the City. The Water Plan also discusses the management and development of water resources, as well as efforts relating to the efficient use water. Additional topics include existing and future water conservation measures, water recycling, and management of the City's groundwater basins.

---

As a covered entity under Title II of the Americans with Disabilities Act, the City of Los Angeles does not discriminate on the basis of disability and, upon request, will provide reasonable accommodation to ensure equal access to its programs, service and activities. To ensure availability, such request should be made 72 hours in advance by calling (213) 367-1361, TDD: 1(800) 432-7397.

# Draft 2010 Urban Water Management Plan NEW WORKSHOP DATES\*

The public is invited to hear an overview of the LADWP Water System's strategic priorities and preview the draft 2010 Urban Water Management Plan that will outline the City's long-term water resources management strategy.



**\* Workshops originally scheduled for January 13 and 18 have been moved to:**

THURSDAY, FEBRUARY 3	WEDNESDAY, FEBRUARY 9
<p>6:00 p.m. <b>VAN NUYS</b> Van Nuys Service Center 14401 Saticoy Street</p>	<p>6:00 p.m. <b>DOWNTOWN LOS ANGELES</b> LADWP John Ferraro Building, Cafeteria Conference Room 111 N. Hope St.</p>

Free parking provided.

**Presentation to be followed by public comment.**

Public input received from the workshop will be considered for the final 2010 UWMP. The final 2010 UWMP will be presented for adoption by the LADWP Board of Commissioners in May 2011.

**About the UWMP:**

The UWMP will address requirements under California Water Code Sections 10610 through 10657. The purpose of the UWMP is to cover the management and development of water resources, as well as efforts relating to efficient use of water. The UWMP addresses the areas of existing and future water conservation measures, water recycling, stormwater capture, and management of the City's groundwater basins. In addition, the UWMP offers information on the status of Los Angeles' imported water sources, water quality issues, and projections of future water supply and demand for the City.

**Draft 2010 UWMP will be available at [www.ladwp.com](http://www.ladwp.com) after January 13, 2011.**

**Written comments are due no later than March 15, 2011 by email to [simon.hsu@ladwp.com](mailto:simon.hsu@ladwp.com), or by mail to:**  
**LADWP - Water System**  
**111 N. Hope Street, Room 1460**  
**Los Angeles, CA 90012**  
**Attn: Simon Hsu**

**For questions**, please call Simon Hsu at (213) 367-2970.

As a covered entity under Title II of the Americans with Disabilities Act, the City of Los Angeles does not discriminate on the basis of disability and, upon request, will provide reasonable accommodation to ensure equal access to its programs, service and activities. To ensure availability, such requests should be made 72 hours in advance by calling (213) 367-2970, TDD: 1 (800) 432-7397.

# Internet Outreach

## Twitter



## LADWP News

DATE: February 7, 2011 11:47:39 AM PST



**LOS ANGELES DEPARTMENT OF WATER AND POWER**  
111 North Hope St., Room 1520, Los Angeles, CA. 90012-5701  
Phone (213) 367-1361 - After Hours (213) 367-3227  
www.ladwp.com



FOR IMMEDIATE RELEASE  
February 7, 2011

### Urban Water Management Plan Workshop this Wednesday at 6pm in Downtown Los Angeles

#### *Help Us Plan LA's Water Future!*

**WHAT:** The public is invited to hear an overview of the LADWP Water System's strategic priorities and preview the draft 2010 Urban Water Management Plan that will outline the City's long-term water resources management strategy. Workshop attendees are invited to share their thoughts during the program.

**WHO:** LADWP Water System Representatives

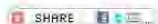
**WHEN:** Wednesday, February 9, 2011  
6:00 p.m.

**WHERE:** LADWP John Ferraro Building  
Cafeteria Conference Room  
111 N. Hope Street  
Los Angeles, CA 90012  
Map

**WHY:** LADWP is currently preparing the 2010 Urban Water Management Plan (UWMP), which will outline the City's long-term water resources management strategy. Public input received from the workshops will be considered for the final 2010 UWMP, to be presented for adoption by the LADWP Board of Commissioners in May 2011.

For more information on the UWMP workshop, click here.

###





## facebook

facebook

Email

Password

Login

Keep me logged in [Forgot your password?](#)

Sign Up **Facebook helps you connect and share with the people in your life.**

### LADWP Draft 2010 Urban Water Management Plan Workshop

Share · Public Event

**Time** Thursday, February 3 · 6:00pm - 9:00pm

**Location** Van Nuys Service Center  
14401 Saticoy Street  
Van Nuys, CA

**Created By** [SOCAL ASLA](#)

**More Info** <http://www.lariver.org/>

#### Wall

[Export](#) · [Report Event](#)

Facebook © 2011 · [English \(US\)](#)

[Mobile](#) · [Find Friends](#) · [Badges](#) · [People](#) · [Pages](#) · [About](#) · [Advertising](#) ·

[Developers](#) · [Careers](#) · [Privacy](#) · [Terms](#) · [Help](#)

# United Neighborhoods (Neighborhood Council) Website

<a href="#">Board Members</a>	<a href="#">Current Agenda</a>
-------------------------------	--------------------------------

**Urban Water Management Plan  
Workshop this Wednesday at 6pm in  
Downtown Los Angeles**

Help Us Plan LA's Water Future!

**WHAT:**  
The public is invited to hear an overview of the LADWP Water System's strategic priorities and preview the draft 2010 Urban Water Management Plan that will outline the City's long-term water resources management strategy. Workshop attendees are invited to share their thoughts during the program.

**WHO:**  
LADWP Water System Representatives

**WHEN:**  
Wednesday, February 9, 2011  
6:00 p.m.

**WHERE:**  
LADWP John Ferraro Building  
Cafeteria Conference Room  
111 N. Hope Street  
Los Angeles, CA 9012


[Map](#)

**WHY:**  
LADWP is currently preparing the 2010 Urban Water Management Plan (UWMP), which will outline the City's long-term water resources management strategy. Public input received from the workshops will be considered for the final 2010 UWMP, to be presented for adoption by the LADWP Board of Commissioners in May 2011.

For more information on the UWMP workshop, [click here](#).

# Foreign Language Publications Advertisements for February 2011 Public Workshops

## Korean Daily

Los Angeles  Department of Water & Power

### LA 시 수자원의 미래를 지키기 위한 전략 과제

LA 수도전력국의 전략적 우선과제의 개요와 LA 시의 장기적 수자원 관리 전략의 윤곽을 그릴 2010 여반 워터 매니지먼트 플랜 (UWMP)의 초안에 대해 함께 논의하고자 귀하를 초대합니다. 최종 2010 UWMP는 2011년 5월 LA 수도전력국 임원회에서 채택을 발표하게 됩니다.

---

### 퍼블릭 워크샵

#### VAN NUYS

2월 3일 목요일 오후 6시  
Van Nuys Service Center  
14401 Saticoy Street

#### DOWNTOWN LOS ANGELES

2월 9일 수요일 오후 6시  
LADWP John Ferraro Building, Cafeteria Conference Room  
111 N. Hope Street


..... 무료 파킹 제공 .....

2010 UWMP 초안은 [www.ladwp.com](http://www.ladwp.com)에서 확인하실 수 있으며 서면으로 된 의견은 2011년 3월 15일까지 아래의 주소나 이메일로 보내주시시오:  
LADWP, 111 N. Hope St, Room 1460, Los Angeles, CA 90012,  
Attn: Simon Hsu or [simon.hsu@ladwp.com](mailto:simon.hsu@ladwp.com)

더 자세한 사항은 (213) 367-2970으로 문의하시거나 [Simon.hsu@ladwp.com](mailto:Simon.hsu@ladwp.com)으로 이메일을 보내주시길 바랍니다

As a covered entity under Title II of the Americans with Disabilities Act, the City of Los Angeles does not discriminate on the basis of disability and, upon request, will provide reasonable accommodation to ensure equal access to its programs, service and activities. To ensure availability, such requests should be made 72 hours in advance by calling (213) 367-2970, TDD: 1 (800) 432-7397.

## La Opinion

Los Angeles  Department of Water & Power

### ASEGURANDO EL FUTURO DEL AGUA DE LOS ANGELES

El público está invitado para conocer un panorama general de las prioridades estratégicas del Sistema de Agua de LADWP y una vista previa del proyecto Plan de Gestión del Agua 2010 (UWMP, por sus siglas en inglés) que será una idea general de la estrategia para el manejo de recursos del agua de la ciudad a largo plazo. El UWMP 2010 final será presentado para su aprobación por el Concejo de Comisionados de LADWP en mayo de 2011.

---

### Talleres Públicos

#### VAN NUYS

Jueves 3 de febrero, 6:00 p.m.  
Centro de Servicio Van Nuys,  
14401 Saticoy Street

#### CENTRO DE LOS ANGELES

Miércoles 9 de febrero, 6:00 p.m.  
LADWP Edificio John Ferraro  
Sala de Conferencias Cafetería  
111 N. Hope Street


..... Estacionamiento Gratuito .....

El proyecto UWMP 2010 está disponible en [www.ladwp.com](http://www.ladwp.com) Comentarios escritos se reciben hasta el 15 de marzo de 2011 a:  
LADWP, 111 N. Hope St, Sala 1460, Los Angeles, CA 90012,  
Attn: Simon Hsu o [simon.hsu@ladwp.com](mailto:simon.hsu@ladwp.com)

Para más información contactar al (213) 367-2970 o al correo electrónico [simon.hsu@ladwp.com](mailto:simon.hsu@ladwp.com)

Como una entidad cubierta bajo el Título III de la Ley de Americanos con Discapacidades, la ciudad de Los Angeles no discrimina por motivos de discapacidad y, previa solicitud, proveerá ajustes razonables para asegurar la igualdad de acceso a su programa, servicios y actividades. Para asegurar la disponibilidad, las solicitudes deberán hacerse con 72 horas de anticipación llamando al (213) 367-2970, TDD 1 (800) 432-7397.

## Sing Tao (Chinese)

Los Angeles  Department of Water & Power

# 保障洛縣 未來用水

歡迎民眾參加洛縣水電局介紹用水系統的策略重點  
及預覽概述城市的長遠用水資源管理戰略的  
2010城市用水資源管理計劃(UWMP)草案。  
最終的2010城市用水資源管理計劃  
將於2011年5月提交洛縣水電局董事會通過。

## 社區研討會 VAN NUYS

2/3/2011 (星期四) 下午六時

Van Nuys Service Center  
14401 Saticoy Street

## 洛杉磯市中心

2/9/2011 (星期三) 下午六時

LADWP John Ferraro Building, Cafeteria Conference Room  
111 N. Hope Street

免費停車

2010城市用水資源管理計劃(UWMP)草案詳情，

請上網至[www.ladwp.com](http://www.ladwp.com)

書面意見請於3/15/2011前寄到：

LADWP, 111 N. Hope St, Room 1460, Los Angeles, CA 90012,  
Attn: Simon Hsu or [simon.hsu@ladwp.com](mailto:simon.hsu@ladwp.com)

查詢電話：(213)367-2970或

電郵 [simon.hsu@ladwp.com](mailto:simon.hsu@ladwp.com)

在美國殘障法案第二條所保障下，洛杉磯市沒有歧視殘障者的基本人權，並且一旦有所要求時，將會提供合理的協助，以確保對洛杉磯市之節目、服務以及活動的公平性。為確保時限有效，任何要求必須在72小時前撥打(213) 367-2970，聽力障礙者專線：1(800) 432-7397。



ANTONIO R. VILLARAIGOSA  
*Mayor*

Commission  
THOMAS S. SAYLES, *President*  
ERIC HOLOMAN, *Vice-President*  
CHRISTINA E. NOONAN  
JONATHAN PARFREY  
BARBARA E. MOSCHOS, *Secretary*

RONALD O. NICHOLS  
*General Manager*

March 3, 2011

Mr. Sol Blumenfeld  
Community Development Director  
City of Culver City, Planning Division  
9770 Culver Boulevard  
Culver City, CA 90232

Dear Mr. Blumenfeld:

Subject: City of Los Angeles 2010 Urban Water Management Plan Public Hearing

The Los Angeles Department of Water and Power (LADWP) is providing this notice of a public hearing for our 2010 Urban Water Management Plan (UWMP). As part of its regularly scheduled meeting on May 3, 2011, the Los Angeles Board of Water and Power Commissioners will hold a public hearing during which members of the public may comment on the adoption of our 2010 UWMP. The hearing will be held on May 3, 2011 at 1:30 p.m. (tentative), 111 N. Hope Street, Room 1555, Los Angeles, CA 90042. Please check the website (<http://www.ladwp.com>) to confirm the start time.

The 2010 UWMP outlines the City of Los Angeles' (City) long-term water resources management strategy. It is the City's master plan for water supply and resources management. It includes details on LADWP's plans for recycled water, conservation, stormwater capture and other water resource options.

All large California urban water agencies prepare an UWMP every five years. The LADWP's 2010 UWMP is currently available for review on our website at (<http://www.ladwp.com>) by searching "UWMP."

If you have any questions or comments, please contact Mr. Simon Hsu of my staff at (213) 367-2970, or e-mail him at [simon.hsu@ladwp.com](mailto:simon.hsu@ladwp.com).

Sincerely,


Thomas M. Erb  
Director of Water Resources

CR:lsf

c: Mr. Simon Hsu

## Water and Power Conservation ... a way of life

111 North Hope Street, Los Angeles, California 90012-2607 Mailing address: Box 51111, Los Angeles 90051-5700  
Telephone: (213) 367-4211 Cable address: DEWAPOLA

Recyclable and made from recycled waste. 



ANTONIO R. VILLARAIGOSA  
*Mayor*

Commission  
THOMAS S. SAYLES, *President*  
ERIC HOLOMAN, *Vice-President*  
CHRISTINA E. NOONAN  
JONATHAN PARFREY  
BARBARA E. MOSCHOS, *Secretary*

RONALD O. NICHOLS  
*General Manager*

March 3, 2011

Ms. Gail Farber  
Los Angeles County Department of Public Works  
900 South Fremont Avenue  
Alhambra, CA 91803

Dear Ms. Farber::

Subject: City of Los Angeles 2010 Urban Water Management Plan Public Hearing

The Los Angeles Department of Water and Power (LADWP) is providing this notice of a public hearing for our 2010 Urban Water Management Plan (UWMP). As part of its regularly scheduled meeting on May 3, 2011, the Los Angeles Board of Water and Power Commissioners will hold a public hearing during which members of the public may comment on the adoption of our 2010 UWMP. The hearing will be held on May 3, 2011 at 1:30 p.m. (tentative), 111 N. Hope Street, Room 1555, Los Angeles, CA 90042. Please check the website (<http://www.ladwp.com>) to confirm the start time.

The 2010 UWMP outlines the City of Los Angeles' (City) long-term water resources management strategy. It is the City's master plan for water supply and resources management. It includes details on LADWP's plans for recycled water, conservation, stormwater capture and other water resource options.

All large California urban water agencies prepare an UWMP every five years. The LADWP's 2010 UWMP is currently available for review on our website at (<http://www.ladwp.com>) by searching "UWMP."

If you have any questions or comments, please contact Mr. Simon Hsu of my staff at (213) 367-2970, or e-mail him at [simon.hsu@ladwp.com](mailto:simon.hsu@ladwp.com).

Sincerely,

Thomas M. Erb  
Director of Water Resources

CR:lsf

c: Mr. Simon Hsu

**Water and Power Conservation ... a way of life**

111 North Hope Street, Los Angeles, California 90012-2607 Mailing address: Box 51111, Los Angeles 90051-5700  
Telephone: (213) 367-4211 Cable address: DEWAPOLA

Recyclable and made from recycled waste.



ANTONIO R. VILLARAIGOSA  
Mayor

Commission  
THOMAS S. SAYLES, *President*  
ERIC HOLOMAN, *Vice-President*  
CHRISTINA E. NOONAN  
JONATHAN PARFREY  
BARBARA E. MOSCHOS, *Secretary*

RONALD O. NICHOLS  
General Manager

March 3, 2011

Mr. Oscar Delgado, Director  
City of West Hollywood  
Department of Public Works  
8300 Santa Monica Boulevard  
West Hollywood, CA 90069

Dear Mr. Delgado:

Subject: City of Los Angeles 2010 Urban Water Management Plan Public Hearing

The Los Angeles Department of Water and Power (LADWP) is providing this notice of a public hearing for our 2010 Urban Water Management Plan (UWMP). As part of its regularly scheduled meeting on May 3, 2011, the Los Angeles Board of Water and Power Commissioners will hold a public hearing during which members of the public may comment on the adoption of our 2010 UWMP. The hearing will be held on May 3, 2011 at 1:30 p.m. (tentative), 111 N. Hope Street, Room 1555, Los Angeles, CA 90042. Please check the website (<http://www.ladwp.com>) to confirm the start time.

The 2010 UWMP outlines the City of Los Angeles' (City) long-term water resources management strategy. It is the City's master plan for water supply and resources management. It includes details on LADWP's plans for recycled water, conservation, stormwater capture and other water resource options.

All large California urban water agencies prepare an UWMP every five years. The LADWP's 2010 UWMP is currently available for review on our website at (<http://www.ladwp.com>) by searching "UWMP."

If you have any questions or comments, please contact Mr. Simon Hsu of my staff at (213) 367-2970, or e-mail him at [simon.hsu@ladwp.com](mailto:simon.hsu@ladwp.com).

Sincerely,

Thomas M. Erb  
Director of Water Resources

CR:lsf

c: Mr. Simon Hsu

**Water and Power Conservation ... a way of life**

111 North Hope Street, Los Angeles, California 90012-2607 Mailing address: Box 51111, Los Angeles 90051-5700  
Telephone: (213) 367-4211 Cable address: DEWAPOLA

Recyclable and made from recycled waste.

## 60-Day Notification Ads (March 3 and 10, 2011)

La Opinion

Metropolitan News

TENGA PRESENTE que como parte de su reunión programada para el 3 de mayo de 2011, la Junta de Comisionados de Agua y Energía realizara una audiencia pública durante la cual cualquier miembro del publico podrá comentar sobre la adopción del Plan de Gestión Urbano del Agua 2011 (UWMP, por sus siglas en inglés).

La audiencia se llevara a cabo a la 1:30 p.m. (tentativamente) el 3 de mayo de 2011, 111 N. Hope Street, Los Angeles, cuarto 1555.

Favor de revisar nuestro sitio en la red en:  
(<http://www.ladwp.com>) y buscar en "UWMP"

Los Angeles Department  
of Water and Power

### NOTIFICATION OF PUBLICATION

STATE OF CALIFORNIA  
COUNTY OF LOS ANGELES

KIM HUGHES

DEPT OF WATER AND POWER  
GOVT LEGISLATIVE & PUB AFFAIR  
111 N HOPE ST RM 1510  
LOS ANGELES CA 90012

NOTICE  
2010 URBAN WATER MANAGEMENT PLAN  
(UWMP)

HEARING/CLOSE/SALE DATE: 05/03/11

The undersigned says:

I am over the age of 18 years and a citizen of the United States. I am not a party to and have no interest in this matter. I am a principal clerk of the METROPOLITAN NEWS-ENTERPRISE\*, a newspaper of general circulation in the City of Los Angeles, the Judicial District of Los Angeles, the County of Los Angeles, and the State of California, as adjudicated in Los Angeles Superior Court Case No. 601165. The notice, a printed copy of which appears hereon, was published on the following date(s): Mar 3,10, 2011

I declare under penalty of perjury that the foregoing is true and correct. Executed at Los Angeles, California on 03/10/11.

  
signature

Metropolitan News-Enterprise  
P.O. Box 60859  
Los Angeles, Ca 90060

Phone: (213) 346-0033  
Fax: (213) 687-3886

Cust. Num.: 012120  
Cust. Ref. Num.:

Control Num.: 851942



NOTICE OF PUBLIC HEARING  
PLEASE TAKE NOTICE that as part of its regularly scheduled meeting on May 3, 2011, the Board of Water and Power Commissioners will hold a public hearing during which any members of the public may comment on the adoption of the 2010 Urban Water Management Plan (UWMP). The hearing will be held at 1:30 pm (tentative) on May 3, 2011, 111 N. Hope Street, Los Angeles, CA, Room 1555. Please check the website (<http://www.ladwp.com>) to confirm the start time. The UWMP is currently accessible for review on our website (<http://www.ladwp.com>) by searching for "UWMP".  
Los Angeles Department of Water and Power  
CN851942 Mar 3,10, 2011  




# **PUBLIC COMMENTS**

## **WORKSHOP PUBLIC COMMENTS**

Following is a summary of questions, comments received, as well as LADWP responses at public workshops on the City of Los Angeles Draft 2010 Urban Water Management Plan (UWMP). The first round of public workshops were held on January 12th and 20<sup>th</sup>, 2010 and then a second round was held on February 3<sup>rd</sup> and 9<sup>th</sup>, 2011.

## Los Angeles Department of Water and Power

### 2010 Urban Water Management Plan Public Workshop Comments/Suggestions for What Should be Included in the Plan

#### INCLUDES LADWP COMMENT RESPONSES

**Date:** January 12 and January 20, 2010  
**Time:** 6:00 – 8:30 pm and 5:00 – 7:00 pm (respectively)  
**Location:** Marvin Braude Constituent Center, 6262 Van Nuys Blvd., Van Nuys, Room 1B  
Los Angeles River Center, 570 West Avenue 26, Los Feliz Room

---

**Participants:** LADWP (Thomas Erb, David Pettijohn, Simon Hsu, Chris Repp), See Also attached sign-in sheet

---

**Meeting Objective:** To present a preliminary summary of the topics to be addressed in the 2010 Urban Water Management Plan (UWMP), and collect comments/suggestions for what should be included in the Plan from the public on these various topics.

If you feel your suggestion is not included, please let us know by e-mailing [chris.repp@ladwp.com](mailto:chris.repp@ladwp.com) or calling (213)367-4736.

#### Links for Workshop Requests

- Plume contamination drawings for the San Fernando Valley, Figures 3-1 to 3-8:  
[http://yosemite.epa.gov/r9/sfund/r9sfdocw.nsf/3dc283e6c5d6056f88257426007417a2/49aa6d700fbae1988825763200575b46/\\$FILE/2007\\_SFV\\_Report\\_1\\_Main.pdf](http://yosemite.epa.gov/r9/sfund/r9sfdocw.nsf/3dc283e6c5d6056f88257426007417a2/49aa6d700fbae1988825763200575b46/$FILE/2007_SFV_Report_1_Main.pdf)
- Graywater systems for residential buildings from the Dept. of Building and Safety:  
[http://www.ladbs.org/LADBSWeb/LADBS\\_Forms/InformationBulletins/IB-P-PC2008-012Graywater.pdf](http://www.ladbs.org/LADBSWeb/LADBS_Forms/InformationBulletins/IB-P-PC2008-012Graywater.pdf)
- Summer 2009 Water Main Leak Preliminary Investigation Report (dated November 2009):  
[http://www.ladwpnews.com/posted/1475/Summer\\_09\\_Water\\_Main\\_Leaks\\_Prelim\\_Investigation\\_Rpt\\_.398503.pdf](http://www.ladwpnews.com/posted/1475/Summer_09_Water_Main_Leaks_Prelim_Investigation_Rpt_.398503.pdf)

#### Groundwater

1. **Comment:** The groundwater recharge program should be expanded. The vast majority of the LA River and other stormwater runoff wastefully flows directly to the ocean. Much more of the runoff within the City needs to be captured to recharge our aquifers or supplement other supplies.

**Response:** LADWP will be preparing a Stormwater Capture Master Plan which will address the potential of stormwater capture infiltration and distributed stormwater capture projects. The Stormwater Capture Master Plan is covered in Section 7.3 of the draft report.

#### Stormwater Capture and Graywater

2. **Comment:** Land use should be changed to allow more rainwater harvesting and stormwater capture. If a developer wants to build and consequently use more water, they should be required to provide open space to be used for stormwater capture. The City codes should have more emphasis on promoting stormwater capture.

## Los Angeles Department of Water and Power

### 2010 Urban Water Management Plan Public Workshop Comments/Suggestions for What Should be Included in the Plan

**Response:** On December 17, 2010, the L.A. City Council directed the Los Angeles City Attorney to draft language for a Low Impact Development (LID) Ordinance addressing new development.

- 3. Comment:** LADWP should communicate more with other City agencies (LA City Bureau of Engineering) on LA River and other watershed issues to increase stormwater capture.

**Response:** LADWP is working with other City agencies and the LA County Flood Control District to enhance Stormwater Capture. This is detailed in Chapter 7 and 10, particularly in sections 7.1, 7.3, 7.7, and 10.2. LADWP involvement with the LA River is covered in section 10.2, under *Los Angeles River*, and *Agency Coordination*. A case study on the LA River Revitalization is also included in Chapter 3.

- 4. Comment:** A good way to study sustainable use and stormwater capture potential is to get universities and large public facilities involved.

**Response:** The Stormwater Capture Master Plan will examine alternative methods to implement Stormwater Capture.

- 5. Comment:** In terms of Recycled Water Systems for private family residents, the City should implement incentives for graywater applications (see link on first page), rainbarrels, and cisterns.

**Response:** LADWP continually assesses conservation programs. For stormwater capture solutions, the Stormwater Capture Master Plan will review potential incentives. The link to the graywater regulations is provided on the first page (Refer to “Links for Workshop Requests”). The Bureau of Sanitation conducted a pilot study for rain barrel use in the City. It is discussed in Chapter 7 of the draft report as “Case Study: Ballona Creek Watershed Rainwater Harvesting Pilot Program”. The Bureau of Sanitation, Watershed Protection Division, began the City’s first free Rainwater Harvesting pilot program in July 2009.

- 6. Comment:** It would be advantageous if there was an action body or group within the City that the public could work with to speed the development of small scale rainwater capture and graywater applications.

**Response:** LADWP will continue to look for ways to work with other agencies and stakeholders in advancing stormwater capture solutions. Implementation of Low Impact Development (LID) will significantly facilitate the development of stormwater capture and graywater applications. The link to the graywater regulation is provided on the first page. The LADWP website is currently being revised and should contain additional information on graywater once complete. See also response number 8.

- 7. Comment:** In the UWMP there should be more emphasis on practical examples of stormwater capture and rainwater harvesting. More pamphlet materials would also be helpful.

**Response:** **Chapter 7 – Watershed Management** provides three case studies on neighborhood recharge, rainwater harvesting, and stormwater capture. More information will be available following the completion of the Stormwater Capture Master Plan, as part of public outreach. See also response number 8.

- 8. Comment:** The new UWMP plan should have specific guidelines and instructions of how to implement graywater and other water saving systems. This would include how to obtain permits from Building and Safety, and would streamline the entire process.

**Response:** The link to the graywater regulations is provided on the first page (above) and Section 3.3.1 of the draft 2010 UWMP. It states that a permit is not required for untreated residential graywater systems using water from

## Los Angeles Department of Water and Power

### 2010 Urban Water Management Plan Public Workshop Comments/Suggestions for What Should be Included in the Plan

clothes washers. Furthermore, The LADWP webpage is currently being revised, and once complete will contain updated information on promoting graywater. The website will familiarize our customers with graywater and promote safe and legal installations of graywater systems. It will include various graywater systems, permits required, water saving estimates, frequently asked questions, and additional information resources. LADWP has obtained International Association of Plumbing and Mechanical Officials (IAPMO) approval to use and modify copyrighted material (i.e. graywater figures) to reflect California State regulations.

#### Water Recycling

9. **Comment:** There should be an emphasis not only on large scale recycling but also on small scale recycling as in rainwater harvesting and graywater applications.

**Response:** Section 7.6, entitled Distributed Stormwater Capture, discusses several types of de-centralized stormwater capture, including rain barrels, cisterns, rain gardens, and several neighborhood recharge projects. Graywater is discussed in the Conservation Chapter in Section 3.3.1 and mentioned in response 8 above.

10. **Comment:** Setting incremental goals for recycled water past 2019 onto 2035 is a positive step in meeting the challenge of dependence on imported water. Increasing the amount of recycled water used not only for environmental use, but to replace potable water, is the right direction for the City.

**Response:** Chapter 4, Recycled Water, discusses these very issues, covering LADWP's recycled water program for the next 25 years. It includes plans for groundwater replenishment, along with recycled water "purple pipe" distribution projects to industries and businesses within the City.

#### Costs

11. **Comment:** There is a concern of the increase of water rates, the costs for planned projects, and the marginal costs of various sources of water supply.

**Response:** With the exception of the proposed groundwater remediation efforts in the San Fernando Valley, it is believed all resource initiatives in the 2010 UWMP can be funded with current water rates. The groundwater cleanup project is a very costly large scale project, and will require additional funding. Unit costs of various sources of supply are covered in Chapter 11, Section 11.1.

12. **Comment:** The additional funding from increased water rates should be used to improve the water infrastructure.

**Response:** Infrastructure improvements (reliability), compliance with regulatory requirements (safety), increasing local supply, protecting the environment (sustainability) and maintaining competitive water rates are the top water priorities for LADWP.

13. **Comment:** The decision to implement particularly expensive projects throughout the City should be based more upon environmental and economical feasibility than on neighborhood influence. This benefits the greater good of the community.

**Response:** When moving forward with expensive water resource projects, LADWP considers environmental and economical feasibility. A good example is that recycled water is favored over seawater desalination mainly because of its more competitive cost and lesser environmental impact.

## Los Angeles Department of Water and Power

### 2010 Urban Water Management Plan Public Workshop Comments/Suggestions for What Should be Included in the Plan

#### New Developments

14. **Comment:** There should be a link between water supply and community development planning.

**Response:** The link between water supply and development planning is explained in Section 11.4, Water Supply Assessments.

15. **Comment:** New developments (particularly those on multi family residences) should bear a greater burden for the costs of acquiring water. The cost of acquiring additional water supply is unjustly being shared by the rate payers.

**Response:** This comment will be recorded and included in the appendix of the 2010 UWMP.

16. **Comment:** In terms of conservation, some high-density projects may be beneficial in ways such as allocating more open space that can be used for stormwater capture.

**Response:** The City of Los Angeles is close to adopting a low impact development (LID) ordinance requiring stormwater capture for all new development.

#### Climate Change

17. **Comment:** LADWP needs to educate constituents about the water crisis and the potential effects of dry climate conditions furthering the drought situation. The Department should enlist experts to provide insight into this challenge.

**Response:** Chapter 12 is dedicated to the topic of climate change. LADWP is currently conducting a climate change study regarding its impacts on the Eastern Sierra watershed, which provides water to the Los Angeles Aqueduct.

#### Conservation

18. **Comment:** Some of the lesser known Phase III Water Conservation Ordinance restrictions should not be lifted if they produce a City that is more responsible and efficient.

**Response:** Conservation efforts in Los Angeles have proven very successful, and have significantly increased water use efficiency in the City. The Los Angeles City Council ultimately determines whether or not these restrictions are lifted. At this time LADWP does not recommend any changes.

19. **Comment:** LADWP should work with other City departments to ensure maximum public benefit with the incentive programs. Additional fees across departments may discourage the use of these incentives.

**Response:** LADWP will keep this in mind to ensure incentive programs are effective. LADWP recently worked with the L.A. Department of Building and Safety (LADBS) to eliminate fees for turf removal in parkways.

20. **Comment:** Conservation alone is not adequate to sustain an increasing population. We will need to introduce additional and/or increased supplies.

**Response:** Exhibit 11C of Section 11.2.8, entitled Service Area Reliability Assessment, highlights LADWP's plans to increase our local supplies significantly. This will reduce purchase of imported water from the Metropolitan Water District by approximately 50 percent by 2035.

---

## Los Angeles Department of Water and Power

### 2010 Urban Water Management Plan Public Workshop Comments/Suggestions for What Should be Included in the Plan

#### Water Supplies

21. **Comment:** There is concern over the amount of water used for environmental reasons in the Owens Valley as this supply diversion significantly increases our dependence on imported water.

**Response:** Annually, LADWP diverts up to 95,000 acre-ft (AF) of Los Angeles Aqueduct water for the Owens Lake Dust Mitigation Project. This is one of the City's many environmental challenges. LADWP is proposing dust mitigation solutions on Owens Lake that will not increase water usage from what is currently used.

22. **Comment:** There is concern about meeting our supplies with an ever growing City population, and an interest in seawater desalination. As costs of various water supplies increase, and technological improvements lower operating cost, it may eventually become economically feasible. However desalination still has its fair share of environmental challenges.

**Response:** LADWP has studied seawater desalination and concluded that it presents too many economic and environmental obstacles at this time. LADWP has decided to focus its efforts on water conservation and recycling.

23. **Comment:** It would be beneficial to have a long term vision for eliminating the City's need for water imports.

**Response:** See comment number 20.

#### Miscellaneous

24. **Comment:** There is an interest in the cause of recent water main breaks (See also link on first page); it's relation to the two day water restriction, and the bombardment of overweight trucks.

**Response:** The link on the first page shows the Summer 2009 Water Main Leaks Preliminary Investigation Report. In addition, the Conservation chapter shows the most recent Water Conservation Ordinance amendments, which implement revised Phase III restrictions. In the amendments, odd numbered addresses are allowed to water on Monday, Wednesday, or Friday, while even numbered addresses can water only on Tuesday, Thursday, or Sunday. This is designed to prevent large fluctuations of pressure within the water distribution system.

25. **Comment:** The City should set up a forum with blogs where the public can share ideas and comments on water related issues.

**Response:** As discussed in comment number 6, the LADWP website is currently being revised. It will include Facebook and Twitter links.

## Los Angeles Department of Water and Power

### Summary of 2010 Urban Water Management Plan Public Workshops Comments and Suggestions with LADWP Responses

**Workshop 1:** February 3, 2011, Van Nuys Service Center, 14401 Saticoy St.

**Workshop 2:** February 9, 2011, LADWP John Ferraro Building, 111 N. Hope St.

**Attendees:** See attached sign-in sheets

---

#### Water Demands

1. **Comment:** How long has the State Department of Water Resources required submittal of Urban Water Management Plans (UWMP)? Historically, how accurate have the projections been?

**Response:** The water demand projections and UWMP have been a requirement since the UWMP Act was established in 1984. Historically, LADWP's projections have turned out to be higher than actual use. The 2010 UWMP is the first UWMP where water demand projections are significantly lower than previous versions. Section 2.3 provides a description of the demand forecast methodology.

2. **Comment:** Water demand projections are significantly lower than those developed in the 2005 UWMP. Why is this?

**Response:** As stated above, previous projections were higher than what actually occurred. For this UWMP, LADWP devoted a lot of study on projected water demands and developed a new forecasting model. Water efficient practices and numerous regulations effecting water use are much more commonplace than in the past, which are expected to prevent significant increases in water demands.

3. **Comment:** The population increased in the last 30 years but water usage has seemed to decrease. However, LADWP has now projected a continual increase with population and increase in water demand. What is changing this historical trend?

**Response:** Today, as compared to the 1970's and 1980's, the City has achieved a much higher level of conservation. This is why our water demand has stayed relatively the same even though the City population has increase by over 1 million since 1970. As the City continues to grow in population, water demand is projected to increase slightly.

4. **Comment:** Why is water use staying relatively the same versus a steady increase of population over time?

**Response:** The City's water use has not increased significantly due changes in customer awareness and efficient use of water, more stringent plumbing standards, LADWP incentives and rebates, and requirements such as mandatory restrictions on water use.

5. **Comment:** Twenty five years from now what percentage of our water supply will come from local water supplies?

**Response:** According to the UWMP 43 percent of water supplies will come from local sources in 2035. By increasing water conservation, recycled water, and stormwater capture, LADWP is projecting to cut the current average annual amount of MWD purchases in half in 25 years.



## Los Angeles Department of Water and Power

### Summary of 2010 Urban Water Management Plan Public Workshops Comments and Suggestions with LADWP Responses

6. **Comment:** Through 2050, the Southern California Association of Governments (SCAG) projects the Southern California area to double in size from 15 to 30 million people. How can we meet these water requirements, especially considering that other adjacent cities are far behind LA and have not implemented such aggressive conservation measures?

**Response:** The major focus of LADWP's UWMP is the development of increased local water supplies to lessen our dependence on imported water that must be shared with all of Southern California. Many other cities in Southern California are pursuing similar local water resource goals. State Senate Bill X7-7 (SBX7-7), passed by the State Senate in 2010 requires a 20 percent reduction in water use by all water agencies by 2020. This requirement will assist in driving other agencies to meet conservation targets.

7. **Comment:** The presentation shows a slight increase in Los Angeles Aqueduct supplies will increase in 2035. Why?

**Response:** The most recent 5-year average Los Angeles Aqueduct deliveries are slightly lower than the historical average. The 2035 projection of Los Angeles Aqueduct deliveries assumes average weather conditions, with a slight decrease due to anticipated climate change impacts.

#### Water Supplies and MWD

8. **Comment:** Where, how, and when is the connection between the State Water Project and Los Angeles Aqueduct (LAA) going to be built?

**Response:** A turnout facility is currently being constructed where the Los Angeles Aqueduct and the California Aqueduct intersect in the Antelope Valley, a few miles west of the 14 freeway. The purpose of the facility is to allow the pumping of water from the California Aqueduct into the Los Angeles Aqueduct and allow LADWP to participate in water transfers from the water market. The turnout facility is currently under construction and should be in service by the summer of 2013.

9. **Comment:** Is there a document that summarizes the structure of water supplies for the City?

**Response:** The UWMP is primary water resource planning documents. It is updated every 5 years.

10. **Comment:** Is LADWP planning to purchase more water from the Bay-Delta?

**Response:** There are a number of water supply and environmental challenges in the Bay-Delta. As outlined in the UWMP, LADWP is planning on decreasing purchases from MWD, which imports water from the Bay-Delta. The UWMP discusses how local water supplies are being developed and how LADWP is planning to rely less on MWD.

11. **Comment:** MWD has been decreasing its allocations from the Bay-Delta via the State Water Project, and Colorado River storage has been decreasing as is evident in Lake Mead's low levels. The City's water demand will increase while LADWP's supply from MWD seems to decrease. How can LADWP reconcile this difference?

## Los Angeles Department of Water and Power

### Summary of 2010 Urban Water Management Plan Public Workshops Comments and Suggestions with LADWP Responses

**Response:** LADWP projects a small increase in water use due to population increases, however the UWMP projects LADWP's reliance on MWD water supplies will be reduced by half; from the current five-year average of 52 percent of total demand to 24 percent by 2035 under average weather conditions. The reliability of MWD's water supplies from both the State Water Project and the Colorado River are discussed in detail in Chapters 8 and 11 of the UWMP.

12. **Comment:** What water will be exchanged when the connection between the California Aqueduct and the Los Angeles Aqueduct is developed?

**Response:** LADWP will seek to purchase water from willing sellers, most likely agricultural entities. State Water Project supplies provided to agencies such as MWD will not be a source of these water purchases.

13. **Comment:** Is there a reciprocal agreement between Metropolitan Water District and LADWP on water transfers occurring at the connection of the California Aqueduct and Los Angeles Aqueduct?

**Response:** Yes, there is a reciprocal agreement between MWD and LADWP. MWD has the exclusive right to sell State Water Project supplies within its service territory. LADWP has the ability to move non-State Water Project water through the California Aqueduct into LADWP's service territory.

14. **Comment:** Are there salinity problems with Colorado River water?

**Response:** Salinity continues to be an issue with Colorado River water supplies. MWD addresses this through water blending. MWD blends Colorado River Aqueduct water with lower salinity State Water Project water.

### Water Conservation and Graywater

15. **Comment:** Is the new watering schedule going to decrease the effectiveness of LADWP's outdoor watering conservation efforts?

**Response:** The new watering schedule went into effect in late August 2010. Since that time, water savings have been essentially unchanged compared to the period prior to the change. Overall monthly conservation savings continue at approximately 20 percent, with single-family residential savings at approximately 25 percent. LADWP will continue to monitor conservation.

16. **Comment:** LADWP should abandon the Irrigation Association Smart Water Application Technologies (SWAT) testing as a means of evaluating weather based irrigation controllers.

**Response:** The SWAT project is an international utility/irrigation industry initiative to achieve landscape water use efficiency through the application of irrigation technology. It includes an independent third party testing protocol for weather based irrigation controllers. LADWP's Water Conservation staff is reviewing this suggestion with the individual who provided it.

17. **Comment:** LADWP should have more information and guides on graywater projects.

**Response:** The LADWP website update will contain information on graywater. Included will be information on benefits, available alternative installations, costs and savings, and how to obtain permits.

## Los Angeles Department of Water and Power

### Summary of 2010 Urban Water Management Plan Public Workshops Comments and Suggestions with LADWP Responses

#### Water Recycling

18. **Comment:** What are LADWP's plans to use recycled water for environmental enhancement improvements?

**Response:** Recycled water is currently being provided for the Sepulveda Basin Japanese Garden, Lake Balboa, the Wildlife Lake, and the Los Angeles River. Those commitments will be maintained as LADWP expands recycled water use.

19. **Comment:** Provide a description of the Recycled Water Master Plan.

**Response:** Section 4.4 of the UWMP describes the components of Recycled Water Master Plan. Once complete, the Recycled Water Master Plan will act as a roadmap for how to expand recycled water in the City.

#### Stormwater Capture

20. **Comment:** Why are the stormwater infiltration goals of 10,000 AF of rainwater harvesting and 15,000 AF of infiltration so low?

**Response:** Currently, stormwater infiltrates and replenishes local groundwater basins so LADWP can fully exercise its pumping rights. The UWMP projects that by 2035 there will be a minimum of 15,000 AFY of increased groundwater pumping in the San Fernando Basin due to water supply augmentation through stormwater infiltration. In order to increase groundwater production, it must be determined that not only have groundwater levels recovered to sustain existing safe yield pumping amounts, but documented additional infiltration is occurring that could potentially increase the safe yield. Increasing the safe yield will require concurrence by the Watermaster and the courts to amend the basin judgment. Amending the judgment would be a lengthy process involving all basin pumpers. More studies must be conducted to determine how much more infiltration must be developed to increase the safe yield and groundwater production. The Stormwater Capture Master Plan will identify the potential acre-feet per year quantities available for recharge, and develop an implementation plan to augment the groundwater basin through centralized and decentralized infiltration projects and programs.

21. **Comment:** Provide a description of the Stormwater Capture Master Plan, and what is its cost?

**Response:** A Request for Proposal for consulting services to prepare a Stormwater Capture Master Plan has been released. The Master Plan's goal is to study the potential for increased stormwater capture and identify feasible alternatives and estimated costs. The cost of the Master Plan will be determined once proposals are received and reviewed, and a contract negotiated.

22. **Comment:** The City states that it will cost \$8 billion for stormwater capture projects. How does the Stormwater Capture Master Plan fit in with this cost?

**Response:** While the City has potential obligations for improving stormwater quality, the Stormwater Capture Master Plan's focus is on developing new water supplies. However, the Stormwater Capture Master Plan will include input from other City departments and examine potential alternatives that achieve multiple objectives.

## Los Angeles Department of Water and Power

### Summary of 2010 Urban Water Management Plan Public Workshops Comments and Suggestions with LADWP Responses

23. **Comment:** Watershed management needs to be evaluated on a regional level.

**Response:** LADWP increasing coordinates with other agencies and organizations on watershed issues, including the United States Army Corps of Engineers, the Los Angeles County Flood Control District, the Greater Los Angeles Integrated Regional Water Management Group, the Los Angeles and San Gabriel Rivers Watershed Council, and numerous environmental organizations and stakeholders. LADWP will continue to work with others to improve regional coordination of watershed management.

24. **Comment:** Construction of more subsurface infiltration basins will help counteract the effects of hardscape in the City.

**Response:** Agreed. LADWP participated in the Elmer Avenue Neighborhood Retrofit Demonstration Project, the North Hollywood Alley Retrofit Project, and other projects to highlight alternatives to impervious hardscape.

25. **Comment:** Required infiltration from roof gutters on property development should prevent more runoff

**Response:** The City's Low Impact Development Ordinance will require stormwater capture and reuse on all new development. Capturing water from roof gutters is one available option to meet the Ordinance requirements.

26. **Comment:** Construction of reservoirs along the Los Angeles River is a good way to enhance infiltration of runoff along the Los Angeles River channel.

**Response:** This option may be feasible if available parcels can be identified and obtained.

27. **Comment:** There are some areas in the City that have historically had repeated flooding. What is being done to solve this problem?

**Response:** While flood control is not LADWP's primary mission, it is possible that areas prone to flooding may also be candidates for stormwater capture projects. Examples are the Elmer Avenue Neighborhood Retrofit Demonstration Project and the recently approved Woodman Avenue Multi-Beneficial Storm Water Capture Project. LADWP will seek involvement by other City departments during the preparation of the Stormwater Capture Master Plan to explore solutions that have multiple benefits.

28. **Comment:** There should be collaboration with the City Planning Department to regulate the structure of roofs and gutters on parking lots, etc., to promote infiltration and water reuse on new projects.

**Response:** LADWP works with other City departments on ordinances to require stormwater capture for all new developments in the City. An example of this is the Low Impact Development (LID) ordinance, currently being drafted by the City Attorney. See Section 7.6.4.

29. **Comment:** How is LADWP working to increase capture of stormwater runoff in urban developments such as parking lots and other hardscape?

**Response:** LADWP is currently participating in various stormwater capture demonstration projects in order to develop alternative city-approved construction standards and gather cost data. An example is the Elmer Avenue Neighborhood Retrofit Project. LADWP actively worked on the development of the Low Impact Development

## Los Angeles Department of Water and Power

### Summary of 2010 Urban Water Management Plan Public Workshops Comments and Suggestions with LADWP Responses

Ordinance currently being drafted, and has begun the process to initiate a Stormwater Capture Master Plan to identify the potential for stormwater capture and identify alternative solutions.

30. **Comment:** Does LADWP partner with other agencies to promote more progressive parking lot strategies and similar approaches to increase stormwater capture?

**Response:** LADWP worked with other City departments on the Low Impact Development Ordinance, and continues to work with other departments on the Green Streets Committee and stormwater capture demonstration projects. Increased stormwater capture from parking lots will be explored in the Stormwater Capture Master Plan.

#### Groundwater

31. **Comment:** What is the percent make-up of the City's local groundwater supply?

**Response:** Historically, 15 percent of the City's total water supply has come from local groundwater. However, due to contamination issues in the San Fernando Basin, the City's largest groundwater source, local groundwater currently comprises only 11 percent of overall water supplies.

32. **Comment:** LADWP has not been able to meet groundwater production as stated in previous Urban Water Management Plans. The Department needs to improve their approach to meet the long-range groundwater goals. How will LADWP do this?

**Response:** Groundwater contamination has prevented LADWP from pumping its full entitlement. LADWP is conducting a comprehensive analysis of groundwater quality to determine the location and type of treatment necessary to fully clean up the contamination. The analysis will lead to specific groundwater treatment project proposals. With groundwater improvements in place, LADWP expects to meet long-range groundwater pumping goals.

33. **Comment:** Water supply issues in the Bay-Delta could be offset by using advanced treated groundwater. What type of treatment technologies are planned for groundwater cleanup in the San Fernando Basin?

**Response:** The analysis of San Fernando Basin contaminants and potential treatment technologies is still being studied. However, potential treatment methods under review include: Air Stripping with Vapor Phase Granular Activated Carbon and Liquid Phase Granular Activated Carbon (for volatile organic compounds), Ion Exchange and/or Biological Treatment (for nitrate and perchlorate), Catalytic Media Filtration (for heavy metals), Ultraviolet Light/Hydrogen Peroxide (for 1,4, dioxane and NDMA), Filtration (for chromium 6), and Reverse Osmosis (for total dissolved solids).

34. **Comment:** Are there groundwater storage opportunities up North in areas outside of the City?

**Response:** Yes. The Antelope Valley contains a large groundwater basin that can be used for groundwater storage. In the Antelope Valley, the City of Los Angeles is a party in current litigation to establish an adjudication that will potentially address storage rights. Other groundwater storage opportunities exist in the San Joaquin Valley. While groundwater storage outside of the Los Angeles basin can assist with water supply management, it

## Los Angeles Department of Water and Power

### Summary of 2010 Urban Water Management Plan Public Workshops Comments and Suggestions with LADWP Responses

is not a new water supply and is potentially costly. LADWP will continue to review opportunities for cost-effective groundwater storage outside of the Los Angeles basin.

#### Costs

35. **Comment:** There is a significant concern over water rates and costs associated with all the projects in the 2010 UWMP.

**Response:** The UWMP includes information on the costs of different resource options. With existing revenues for local supply development, LADWP believes we can achieve the water resource goals as stated in the 2010 UWMP, with the exception of the groundwater cleanup effort which will require rate increases. Section 11.1 addresses unit costs and funding.

36. **Comment:** The LADWP Power System is planning to significantly increase energy rates to support green energy sources. How will the Water System deal with the extra cost of the groundwater cleanup alongside the power cost increase?

**Response:** All proposed rate increases are reviewed with Neighborhood Councils and the public, and the LADWP Board of Commissioners carefully considers the justification and impact of increased rates prior to making any decision. Also, all LADWP rate revisions require approval by the Los Angeles City Council.

#### Climate Change

37. **Comment:** To what region does the climate change study apply?

**Response:** The climate change study LADWP is conducting is specifically for the Eastern Sierra watershed that feeds the Los Angeles Aqueduct. However, Section 12.1 provides information on projected local climate change impacts.

#### Miscellaneous

38. **Comment:** There is an interest in ocean desalination. Why is this not a water supply LADWP is pursuing?

**Response:** Five years ago, LADWP conducted studies and began planning an ocean desalination pilot project adjacent to the Scattergood Power Generation Facility. However, we found desalination to be too costly and have numerous environmental challenges. LADWP determined that conservation and recycling are more cost effective, easier to implement, and more environmentally friendly.

39. **Comment:** Explain the inconsistency whereby City Planning Department updates to the General Plan are not in line with LADWP's updates for the 2010 UWMP projections.

**Response:** The UWMP includes projected population increases provided by demographic projections from Southern California of Governments (SCAG) data. The City's General Plan also uses population forecasts provided by SCAG data; therefore, the UWMP projections are generally consistent with the City's General Plan as both use SCAG projections as their basis. Both of these planning documents are interdependent, however, their updates may not necessarily be on the same schedule.

## Los Angeles Department of Water and Power

### Summary of 2010 Urban Water Management Plan Public Workshops Comments and Suggestions with LADWP Responses

40. **Comment:** The 2010 UWMP should state that the City's water allotment is based on the preferential rights agreement of the MWD Allocation Plan which is now a fixed number and does not increase with City's demographics or demand projections.

**Response:** MWD adopted a Water Supply Allocation Plan in 2008 that is not based on preferential rights. If shortage allocations are required, the calculations established in the Water Supply Allocation Plan equitably allocate available supplies among MWD's member agencies primarily based on need, with adjustments to account for growth, local investments, changes in supply conditions, demand hardening, and water conservation programs.

41. **Comment:** LADWP is doing a good job of projecting demands and implementing conservation, recycling, and stormwater programs; however, LADWP still has a long way to go.

**Response:** The 2010 Urban Water Management Plan highlights the significant potential for increased local resources development.

42. **Comment:** Financial incentives, either positive or negative, should be used to modify water use behavior. Rebates and incentives for exceptional conservation or citations for water waste will help encourage conservation and spread the word of efficient water use.

**Response:** Since November 2008 the Water Conservation Team (formerly know as Drought Busters) have been enforcing the City's Emergency Water Conservation Ordinance, issuing both warnings and citations for water waste. Also, LADWP continues to offer rebates and incentives for all customer types.

43. **Comment:** Development should be limited and should be required to compensate for additional water needs.

**Response:** In December 2009, the High Efficiency Plumbing Ordinance went into effect requiring the next generation of water efficient plumbing fixtures in all new development. Also, the City Attorney is currently drafting the Low Impact Development Ordinance for City Council approval that will require on-site stormwater capture for all new development.

44. **Comment:** In the "Securing L.A.'s Water Future" presentation, under Regulatory Requirements – Other, there are significant proposed expenditures of \$337 million. What are these expenditures for?

**Response:** The largest portion of these proposed expenditures are for air quality requirements at Owens Lake.

45. **Comment:** Please explain the high number of pipe breaks recently. Is it because of the watering schedule?

**Response:** The expert panel formed to examine pipe breaks reviewed possible causes. The panel reviewed whether the 2-day per week watering schedule in place at the time was contributing to the increased frequency of pipe leaks. The 2-day per week watering schedule caused water system pressures to cycle more frequently than prior to watering restrictions. The panel theorized that these pressure cycles increased pipe breaks. In response to that analysis, the City Council modified the watering schedule to 3-days per week watering, with separate watering days for odd and even addresses.

## Los Angeles Department of Water and Power

### Summary of 2010 Urban Water Management Plan Public Workshops Comments and Suggestions with LADWP Responses

46. **Comment:** Explain the budget for groundwater storage.

**Response:** There is \$2 million budgeted for groundwater storage in fiscal year 2010-11 to study groundwater storage opportunities outside of the Los Angeles basin.

47. **Comment:** How many miles of riveted steel pipe does LADWP have?

**Response:** LADWP has 86.3 miles of riveted steel pipe within the city's water distribution system. In addition, the First Los Angeles Aqueduct contains 13.8 miles of riveted pipe.

48. **Comment:** Describe the power usage of the State Water Project in comparison to the Los Angeles Aqueduct?

**Response:** As explained in the UWMP's Section 12.2 entitled "Water Energy Nexus", State Water Project supplies are the most energy intensive, ranging from approximately 2,580 kilowatt hours per acre foot (kWh/AF) for the west branch, to 3,236 kWh/AF for the east branch. The Los Angeles Aqueduct water is conveyed from the eastern Sierra Nevada watershed by gravity flow, and does not require pumping as compared to the State Water Project water. Los Angeles Aqueduct water requires no energy for delivery and generates hydroelectric power as it travels from the eastern Sierra Nevada to Los Angeles.

49. **Comment:** What is LADWP doing to install individual meters for multi-family residences?

**Response:** LADWP supports efforts to encourage individual meters in new multi-family construction. Studies show that customers who pay individual water bills use water more efficiently.

50. **Comment:** When will electronic meters be used?

**Response:** LADWP continues to investigate so-called smart water meters and at this time we do not have an estimate when they will begin to be introduced. Smart water meters allow for more frequent readings and can provide useful water information such as leak detection.

51. **Comment:** What is the current status of the Palos Verdes Reservoir in San Pedro? Is it empty?

**Response:** The Palos Verdes Reservoir is owned and operated by MWD. It is in service, but looks empty since a floating cover is installed. This floating cover is one option that we are investigating for some of our own open reservoirs to meet water quality regulations.

52. **Comment:** Is most of the infrastructure work being done going to be performed by LADWP employees or will any of the work be contracted out?

**Response:** Major water quality improvement projects, such as reservoir covers will be contracted out. Small diameter pipe replacement is performed by LADWP personnel. For large diameter pipelines, it is estimated that approximately half will be contracted out and half performed by LADWP personnel.



## WRITTEN PUBLIC COMMENTS

Following are responses to written correspondences (attached) from Accurate WeatherSet, S.Schron, Edward Saltzberg & Associates Forensic Mechanical Engineers, David Coffin, Phoenix, Aquacell, Heal the Bay, Joyce Dillard, Elmco/Duddy, Environmental Now, TreePeople, and Southern California Watershed Alliance on the City of Los Angeles Draft 2010 Urban Water Management Plan (UWMP).

## **Responses to Written Questions**

### **Heal the Bay, 3/15/11**

**Question:** Why have water recycling goals decreased from the original target?

**Response:** Recycled water projections in the UWMP reflect what can be achieved with the existing amount of annual revenue. Receipt of federal or state grants will allow projections to be increased.

**Question:** LADWP should prioritize stormwater capture projects and set goals for new stormwater capture projects in Los Angeles. When will the Stormwater Capture Master Plan be completed?

**Response:** The Stormwater Capture Master Plan will address these suggestions. It is projected that the Master Plan will be completed by the fall of 2013.

### **Joyce Dillard, 3/15/11**

**Question:** You conclude that outdoor water use is estimated at 39% of demand, but the water demand data in Exhibit 2C does not indicate a reason to come to that conclusion.

**Response:** The projection of outdoor water use is based on estimated water needs for landscape irrigation and an analysis of wastewater system flows compared to total water consumption. Section 2.1 of the UWMP discuss the analysis.

**Question:** What is the definition of non-revenue water use?

**Response:** Non-revenue water use is defined as the difference between the total water supplied to the City and total water sales. Non-revenue water consists of water for used for fire fighting, reservoir evaporation, pipeline leaks, meter errors, theft from hydrants, water used for street sweeping and pipeline flushing for water quality purposes.

### **Environment Now, 3/15/11**

**Question:** Why has LADWP been behind on its water recycling targets compared to the original benchmark? Why have the water recycling goals decreased from the original target?

**Response:** The 2010 UWMP water recycling targets and current progress reflect the current level of revenue. Based on current levels of revenue, LADWP projects they can meet the current water recycling goals. If LADWP is successful in acquiring additional grants, then goals may be increased.

### **TreePeople, 3/15/11**

**Question:** Page 11-8, Exhibit 11E: Note 1 indicates a loss in the LA Aqueduct at 0.1652% per year due to climate change. There is no indication of loss from MWD (California Aqueduct, and Colorado River Aqueducts) due to climate change. Does this account for MWD's projections?

**Response:** MWD's recently adopted 2010 Regional Urban Water Management Plan (RUWMP) and their 2010 Integrated Resources Plan (IRP) documents discuss in detail the potential impacts to supplies to the California and

Colorado River Aqueducts due to climate change. LADWP's draft 2010 Urban Water Management Plan (UWMP) makes references to these to MWD documents.

Although MWD's State Water Project (SWP) contract entitlement is 1,911 thousand acre-feet (TAF), projected SWP water deliveries to MWD are expected to be much less than their full entitlement due to many factors. The State's Department of Water Resources (DWR) issued the 2009 draft Reliability Report which identified climate change as one of the significant factors that could reduce future SWP water deliveries. MWD used the DWR's 2009 Reliability Report in reporting its SWP supply projections in its RUWMP, which was the source document for MWD SWP supplies as reported in the LADWP's 2010 UWMP.

The impacts of climate change is also projected to reduce Colorado River supplies, however, it's not expected to impact California as the state has senior water rights on the use of Colorado River water. Under the Seven Party Agreement of 1931 that divided California's share of the Colorado River supplies among the seven major water uses in the state, MWD's full Priority 4 Apportionment of Colorado River water has been consistently delivered and can reasonably be expected to be available in the future as indicated in their RUWMP. This is due in part to the fact that MWD's allocation of Colorado River holds a senior priority right to both Nevada and Arizona. In effect this means that any shortages on the Colorado River from climate change or other causes up to 1 million acre-feet will be born first by Arizona and Nevada before MWD is impacted.

Please note that MWD's SWP and Colorado River supply projections in their RUWMP indicate no reductions in deliveries even during extended dry periods because MWD has made numerous investments in other water supply and storage programs on the Colorado River, which are in addition to MWD's projected base apportionment and entitlement deliveries. MWD's 2010 IRP also establishes goals for a range of potential "buffer" supplies, up to approximately 500,000 acre-feet, to protect the region from possible shortages due to potential climate change and other impacts to its supplies.

### **Southern California Watershed Alliance (3/28/11)**

**Question:** Regarding Exhibits 2I, 2J, and 2K. While projection of conservation savings go up, the demand seems to rise gradually until 2035. If you take the historic savings in the last few years and combine that with future investments why would demand continue to rise?

**Response:** Exhibit 2I was found to contain some errors and has been corrected and updated. It now shows that per capita water use consistently decreases. Though per capita water use decreases due to increased conservation efforts, demand will continue to increase in the future due to projected economic growth and population increases.

**Question:** Why, on page 3-5, did you choose Method 3 for reporting, when you are already at 19% conservation? If the current gallons per capita per day is 124, by taking this approach you are actually looking at a higher per capita into the future.

**Response:** LADWP reviewed all four available methods for compliance with the State's 20 percent by 2020 water use efficiency mandate and selected Method 3 because it is the most straightforward calculation method which also accounts for the City's past conservation investments.

## **Responses to Written Comments**

### **Edward Saltzberg & Associates Forensic Mechanical Engineers, 2/28/11**

**Comment:** Have a list of abbreviations on a page that readers can refer to if they are not conversant with all of the acronyms. In the written material, spell out what an abbreviation stands for when it's first used in a section.

**Response:** LADWP has created a Glossary of Abbreviations and Terms which is included in the final 2010 UWMP, and reviewed the UWMP to spell out abbreviations when first used.

### **Heal the Bay, 3/15/11**

**Comment:** LADWP should investigate reclaimed water purification as a water supply alternative in the future. LADWP should explore advanced wastewater treatment for future indirect or even direct potable use before exploring seawater desalination as an option for water supply.

**Response:** The UWMP outlines plans for groundwater replenishment of advanced treated recycled water in the San Fernando Valley. The current Recycled Water Master Plan is reviewing the long-term potential of advanced treated water from the Hyperion Wastewater Treatment Plant for groundwater replenishment as well as potential direct potable use.

**Comment:** LADWP should provide further support for Los Angeles Unified School District (LAUSD) to achieve the goals set forth in the LAUSD Water Savings Resolution. In addition to providing financial incentives for retrofits and for new zero-water urinal and high efficiency toilets used in a new construction project, LADWP should provide incentives for new fixtures in redevelopment and retrofit projects as well. In addition to these rebates, LADWP should consider expanding the purple pipe system to LAUSD schools.

**Response:** LADWP does provide conservation rebates and incentives for redevelopment and retrofit projects, in fact, these rebate amounts are significantly more than those for new construction. Some LAUSD schools are currently receiving recycled water. The Recycled Water Master Plan will identify expansion of purple pipe projects to reach additional schools.

### **Mr. David Coffin, 3/7/11**

**Comment:** Water supply projections published in previous UWMP's between 1990 and 2005 have been much higher than actual water supply.

**Response:** It is true that previous UWMP water supply projections turned out to be higher than actual demands. However, it is important to point out that projections of supply reflect what can be produced and delivered if necessary to meet projected demands. If actual demands do not materialize at projected levels, then less supply is produced and delivered to meet those demands.

In previous UWMP's, LADWP anticipated that demands would gradually increase over time. This has not been the case for several reasons. The City has been successful in implementing one of the country's most aggressive water conservation programs. Additionally, demand forecasts could not foresee events such as economic recession, environmental and regulatory restrictions on Delta exports, and the recent multiple dry year conditions throughout California and the Southwest. All of these factors have lead to changes in customer water use behavior resulting in both increased water use efficiency and decreased demands.

The net effect of these changes were that LADWP produced and purchased less water to meet actual demands than was envisioned in previous UWMP's between 1990 and 2005.

**Comment:** UWMP's between 1990 and 2005 seriously miscalculated future groundwater supply projections.

**Response:** We agree that previous UWMP's contained groundwater projections that were significantly higher than the actual groundwater yield. There are several reasons for this over projection. For instance, previous UWMP's groundwater projections envisioned groundwater replenishment with recycled water which would increase groundwater yield. However, previous plans to replenish the groundwater basin with recycled water were halted following public opposition.

In addition, starting in the mid 1980's, LADWP significantly decreased groundwater pumping in order to minimize the migration of a contamination plume toward active wells in the San Fernando Groundwater Basin (SFB). Contamination issues in the SFB continue to adversely affect groundwater pumping. To restore LADWP's full groundwater pumping rights in the SFB, the 2010 UWMP incorporates plans for construction of groundwater contamination treatment facilities. Additionally, the 2010 UWMP includes increases in groundwater pumping due to groundwater replenishment with advanced treated recycled water as well as increased stormwater capture.

**Comment:** Water Supply Assessments should cite the UWMP and not the City's General Plan when assessing the proposed water demand for a project.

**Response:** LADWP does cite the UWMP in water supply assessments in accordance with Water Code Section 10910.

UWMP Section 11.4 Water Supply Assessments states that LADWP's UWMP uses anticipated growth as provided by demographic projections from Southern California of Governments (SCAG) data, re-allocated by MWD into LADWP's service area. The City's General Plan uses population forecasts as provided by SCAG data as well; therefore, the UWMP projections are consistent with the City's General Plan as both use SCAG projections as their basis.

In preparing water supply assessments, LADWP works with the Planning Department to confirm that all proposed projects conform to the City's General Plan.

**Comment:** The City's allocation of water from the Metropolitan Water District is based on property tax assessments and the value of the investments it has made with MWD infrastructure projects.

**Response:** The City's preferential rights to purchase water from MWD, as defined in Section 135 of the MWD Act, was not included in the development of MWD's Water Supply Allocation Plan (WSAP). While it is correct that the City may have this entitlement, no member agency, including the City, has historically ever invoked this entitlement during an allocation of water by MWD.

The WSAP is discussed in the UWMP, Section 11.2.6, entitled "MWD Imported Supplies". LADWP, along with other member agencies, worked collaboratively with MWD in developing the WSAP to equitably allocate water supplies during periods of a regional shortage by taking into account many factors including demands, growth, local investments, changes in supply conditions, and water conservation programs. Preferential entitlement was not a factor in developing the WSAP, which is fundamentally a needs-based allocation plan.

**Joyce Dillard, 3/15/11**

**Comment:** 2035 water demand projections for most customer service sectors exceed the 2005-2010 average water usage. You need to compare the projections with baseline per capita use to see if 20 percent by 2020 compliance can be obtained.

**Response:** Although water use in some customer sectors is projected in to increase, expanded water conservation and water recycling will offset this increase water use. LADWP projects we will be in compliance with 20 by 2020 requirements.

**Comment:** Recycled water cannot be sold to water down dust on horse ranches, yet you consider irrigation usage.

**Response:** The California Department of Public Health and Los Angeles Regional Water Quality Control Board recently provided approval for use of recycled water for dust control subject to certain conditions. LADWP recycled water staff will be working with interested customers to comply with the new regulations so recycled water use can be expanded.

**Comment:** Non-adjudicated groundwater basins such as the Santa Monica Basin and the Hollywood Basin are not addressed.

**Response:** Chapter 6 of the UWMP was amended to mention these unadjudicated basins, and LADWP's plans to revisit previous studies to determine the current potential for expanded groundwater supplies.

**TreePeople, 3/15/11**

**Comment:** Page 2-9 Exhibit 2I – Although we applaud LADWP's leadership in water conservation, we believe much greater water savings can be obtained and will be necessary to meet future local water needs. We believe that LADWP should continue to lead by setting conservation targets that well exceed the minimum 20 x 2020 state mandated goals. Exhibit 2I appears to assume no new innovation or transformation will take place beyond 2015.

**Response:** Exhibit 2I was based on a preliminary demand forecast model and contained erroneous data. It has now been corrected and updated.

**Comment:** Page 3-26: Identify next steps necessary for incorporating graywater systems into LADWP conservation programs.

**Response:** The section on graywater in Chapter 3 was amended to state that LADWP is reviewing the concept of assisting in the creation of ad hoc committees to develop a standard for graywater systems.

**Comment:** Page 7-10 references "Exhibit 7D" which "summarizes the potential water yield and average unit cost of the different resources available to increase localized capture and infiltration of runoff" is missing from the document, or is this referencing the cost table "Exhibit 7H"?

**Response:** The exhibit reference was corrected. Also, Exhibit 7H has now been revised to Exhibit 7G.

**Comment:** Page 7-17 and Exhibit 7H: Update cost table with new figures.

**Response:** Updates have been incorporated into the final 2010 UWMP. Exhibit 7H has been renamed to Exhibit 7G.

**Comment:** Replace “drought tolerant” with “climate appropriate” throughout the document. Climate appropriate is becoming the more accepted description for landscape transformation.

**Response:** This change has been made throughout the final 2010 UWMP.

**Comment:** Page 7-22, Section 7.6.5 Future Distributed Stormwater Programs: Add rain gardens to the list of potential rebates (TreePeople is beginning a pilot rain garden rebate program with the Watershed Management Group).

**Response:** A reference to rain gardens have been added to section 7.6.5.

**Comment:** Page 7-24 (revise language): “Furthermore, distributed stormwater capture projects yield additional benefits to the public outside of water supply generation such as flood control, restored native habitat, community beautification, public right of way improvements, water conservation, as well as private residence safety and aesthetic improvements.”

**Response:** This suggested change has been made.

**Comment:** Chapter 7 General: Revisit the projected stormwater capture estimates as the Stormwater Capture Master Plan is finalized and projects come online. We believe that more than 25,000 acre feet per year can be captured by 2035.

**Response:** The Stormwater Capture Master Plan will comprehensively evaluate stormwater capture potential within the City. Once the Master Plan is complete, LADWP will be able to reevaluate its future stormwater capture goals.

**Comment:** Chapter 11, Exhibits 11E to 11L: Targets for stormwater capture stay consistent at 25,000 AF for both dry and normal years.

**Response:** The 15,000 AFY of increased groundwater production due to stormwater capture is anticipated to be available in every year. The 10,000 AFY of increased conservation due to stormwater capture and reuse will need further analysis in the Stormwater Capture Master Plan.

#### **Southern California Watershed Alliance, 3/28/11**

**Comment:** Given that the UWMP does not include desalination as a projected supply, the historical list of past planning on the issue is confusing and leads one to believe that there are plans to move forward.

**Response:** At this time LADWP has no plans to pursue ocean desalination as a supply.

FROM: Andrew Davis  
Accurate WeatherSet

---

Simon,

In the DRAFT 2010 URBAN WATER MANAGEMENT PLAN, I see page 11-15 section 4 (1) that it states

(1) must have approved weather-based irrigation controllers registered with LADWP (eligible weather-based irrigation controllers are those approved by MWD or the Irrigation Association Smart Water Application Technologies (SWAT) initiative

MWD uses only controller that passed the SWAT testing. So the statement of "approved by MWD or the Irrigation Association Smart Water Application Technologies (SWAT) initiative are equivalent.

SWAT testing a is bad requirement. SWAT testing is meaningless because:

- 1) SWAT testing is done in laboratory under highly technical conditions and not in the field with homeowners and contractors;
- 2) SWAT tests only one controller from each manufacturer which is programmed by the technical staff of the manufacturer;
- 3) test results cover only 30 days;
- 4) manufacturers may suppress bad results, pay another \$3500 testing fee, reprogram their controller and resubmit for another test until the manufacturers get the results that they want.

Below are the published results from SWAT laboratory testing. All ten controllers scored identically on Irrigation Adequacy. All ten controllers scored nearly identically on Irrigation Excess. These nearly identical results were achieved even though their technologies differ widely. From these nearly identical SWAT results, you would expect all controllers to deliver the same water savings.

The results of SWAT testing by some manufacturers have varied over the years as manufactures have suppressed unfavorable results. These manufacturers have reprogrammed and resubmitted their controller for SWAT testing until they get nearly perfect results. Such tests are rigged by manufacturers and meaningless when measuring water conservation in the hands of homeowners and contractors in the field. Because of these flaws, Accurate WeatherSet has NOT submitted its controllers for testing at SWAT.



While SWAT testing "proves" that all controllers are nearly identical, field tests show that is NOT true. The most meaningful test of weather-based irrigation controllers in the field is the 309-page report submitted by MWD and EBMUD to Cal DWR. That engineering field-study was performed by Aquacraft and can be downloaded at [http://www.aquacraft.com/Download\\_Reports/Evaluation\\_of\\_California\\_Smart\\_Controller\\_Programs\\_-\\_Final\\_Report.pdf](http://www.aquacraft.com/Download_Reports/Evaluation_of_California_Smart_Controller_Programs_-_Final_Report.pdf)

This most significant table in that 309-page, multi-year report of 1,000s of controllers shows water savings by manufacturer. Note that we, Accurate WeatherSet, saved MUCH MORE water than any of the other controllers AND our water savings ARE STATISTICALLY SIGNIFICANT and we have the lowest retail price. Look at column labeled **Avg.%Change in Outdoor Use** for water savings that are very different from SWAT testing.

This report shows that Accurate WeatherSet is the lowest cost (see Retail Price column) with the HIGHEST WATER SAVINGS (see **Avg.%Change in Outdoor Use**). Lowest cost with greatest water savings should be highest on your list of controllers to include and is another reason to use 309-page report and reject SWAT testing as your criteria. By achieving 33% outdoor water savings, our controller by itself can reduce water consumption nearly 20% water since 60% to 70% of all water that goes thru a residential meter is used on lawns. This is another reason to include our controller in LA's URBAN WATER MANAGEMENT PLAN.

Please note that the **95% Conf Interval**. Since standard deviation in the chart above was greater than the water savings for most controllers, most controllers did NOT save significant water. This report covers nearly 600 controllers installed in LADWP's service area (see Table ES.3) on page xix. One hundred of the controllers were from Accurate WeatherSet. So the water savings of ALL controllers was not statistically significant because our statistically significant water savings of our controllers was buried by the wide variation in water savings/excess of the other manufacturers.

This 309-page report contains the result of 1,000s of controllers, purchased, installed and programmed by homeowners and contractors. This is real-world testing, not testing in for 30 days in the a laboratory.

This report show the real results that you will have from weather-based irrigation controllers when purchased, installed and programmed by homeowners and contractors and should be used for LA's URBAN WATER MANAGEMENT PLAN to assure success.

Search thru the 309 page report for "SWAT" and see that the report also states that SWAT testing is not designed to measure water conservation.

If you use the 309-page, multi-year field report instead of SWAT testing, you will include my company. A happy feature of including us in your approved list of weather-based irrigation controllers is that you will include/help a company located in the City of Los Angeles in the neighborhood called Winnetka in the west San Fernando Valley. I understand that city agencies are dedicated to encouraging businesses to stay in LA.

Also, I suggest that you talk to Al Pinnaro in LA City Parks & Rec. Last year, he completed a 5-year field study of all the weather-based irrigation controllers and found MANY problems, except with ours. He has ordered controllers from us for installation in LA City parks. You may reach him at 213-216-7351. If you want to give irrigation problems to LA residences and business, then ignore Al Pinnaro and use the SWAT laboratory results. If you want to give well-tested controllers, the listen to Pinnaor's experience over 5 years and eliminate some of the controllers based on his experience AND include us.

LA and California have led the country in science-based standards. Science-based water conservation is the next challenge. Please use the 309 page report and the experience of Al Pinnaro to determine which controllers to include in LA's URBAN WATER MANAGEMENT PLAN.

Will there be anymore public meetings?

Andrew Davis

---

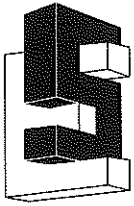
**From:** \*\*\*\*@\*\*\*.com

**Sent:** Sunday, January 30, 2011 10:30 AM

**To:** Hsu, Chiun-Gwo (Simon)

**Subject:** COMMENT/SUGGESTION

Evaporation of water from swimming pools during the summer time can be greatly reduced with the use of pool covers/blankets. I would like the DWP to offer some sort of REBATE for homeowners who invest in pool covers/blankets. thank you, S. Schron



**Edward Saltzberg & Associates  
Forensic Mechanical Engineers**

14733 Oxnard Street  
Van Nuys, California 91411  
818.994.2613  
Fax.818.782.7792  
Ed@ESaltzberg.com

February 28, 2011

LADWP-Water System

111 North Hope Street, Room #1460

Los Angeles, California 90012

Attn: Simon Hsu

RE: Urban Water management Plan

Dear Mr. Hsu:

I thought the publication of the water management plan was very good. However, I have a few suggestions to make it better.

1. Have a list of abbreviations on a page that readers can refer to if they are not conversant with all of the acronyms.
2. In the written material spelled out what an abbreviation stands for when its first used in a section.
3. Make sure that all graphs and charts are properly labeled as to what the units of the chart are. For example exh. 5B, are the units on the left acre feet? There are a few others where the units are not labeled or the title of the chart or graph does not clarify what the chart or graph represents.

I hope that these suggestions help improve the management plan.

Very truly yours,

Edward Saltzberg & Associates

Edward Saltzberg PE, CPD, FASPE

Pres.

**COMMENTS TO THE LOS ANGELES DEPARTMENT OF WATER AND POWER  
2010 DRAFT URBAN WATER MANAGEMENT PLAN**

March 7, 2011

Simon Hsu  
Los Angeles Department of Water and Power  
111 N. Hope St., Room 1460  
Los Angeles, CA 90012

Thank you for the opportunity to comment on the LADWP draft 2010 Urban Water Management Plan (“UWMP” or “water plan”).

Missing from past water plans published from 1990 through today has been a review of past water plans. Deliberation and adoption of a new water plan should be done with an understanding of how well the city has met stated goals in previous plans. Did they meet their targets and goals? Did they fall short? What lessons have been learned? Will the 2010 UWMP follow the same pattern as water plans before it?

Sections 1 and 2 provide an overview of the past water projections and how well the city met those projections.

**1. PROJECTED VERSUS ACTUAL WATER SUPPLY - A REVIEW OF PAST WATER PLANS**

- a. Water plans published between 1990 and 2005 seriously miscalculated future water supply projections (Figure 1). In one example the 1990 UWMP overstated the 2010 water supply projection by 41 percent.
- b. In every projection cited by UWMP’s published between 1990 and 2010, records show that that the city’s actual supply failed to meet expectations by a large amount.
- c. UWMP’s routinely cited water supplies over 700,000 AF and as much as 799,000 AF, yet records show the city has never received more than 699,000 AF of water since 1986.

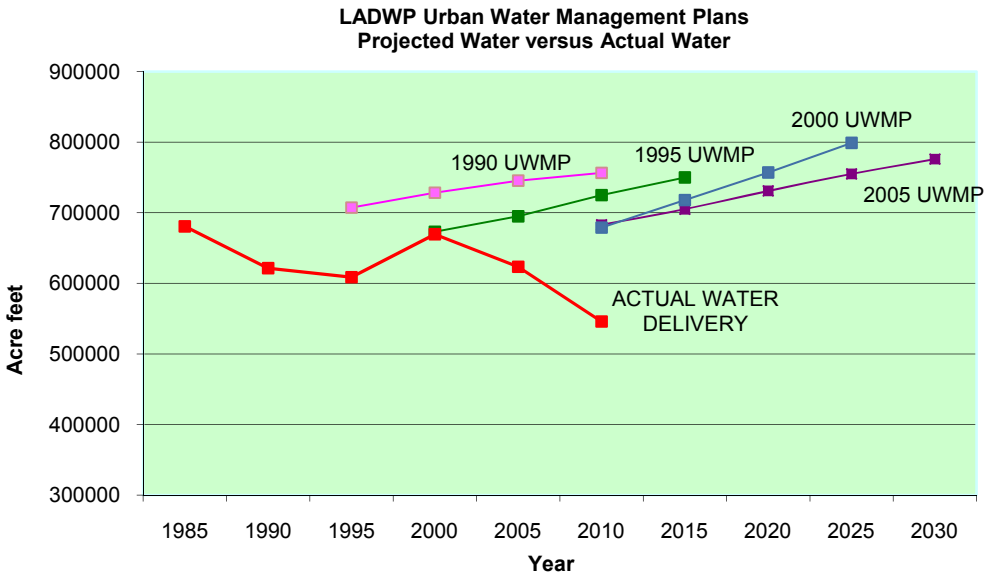


Figure 1 – This chart plots the overstated projections of the past four urban water management plans (1990 through 2005) and compares them with actual water amount received by the LADWP. The 1990 UWMP over-projected water supply by 41 percent for 2010, enough for 146,000 single family housing units.

Given the failure to meet nearly every past projection since 1990, At what point should UWMP’s stop projecting supplies in excess of 700,000 AF when it is an historical fact that the DWP has never been able break through that level?

Twenty years of seriously overstated projections have lead city officials to believe that sufficient water supplies existed when they were faced with assessing infrastructure impacts of large developments seeking city permits. A total of 65 major projects were approved using the projected figures in the 2000 and 2005 UWMP. Records show that not one of the water supply projections used by these assessments were ever met by the city. The approvals of such projects and subsequent failure to meet these projections have led to water supply shortfalls and today’s permanent drought conditions in the area served by LADWP.

**2. PROJECTED VERSUS ACTUAL GROUND WATER SUPPLY - A REVIEW OF PAST WATER PLANS**

- a. Water plans between 1990 and 2005 seriously miscalculated future groundwater supply projections. In some years as high as 195 percent. (See Figure 2)
- b. The city has not met groundwater supply projections anytime in water plans between 1990 and 2010.
- c. All water plans from 1990 through 2010 routinely projected groundwater pumping well above 100,000 AF annually though the actual amount received annually between 1990 and 2010 averaged just 83,582 AF.
- d. The 1995 UWMP over-projected groundwater pumping for 2005 by 178%. Likewise, the 2000 water plan overstated the 2005 projection by 195%.

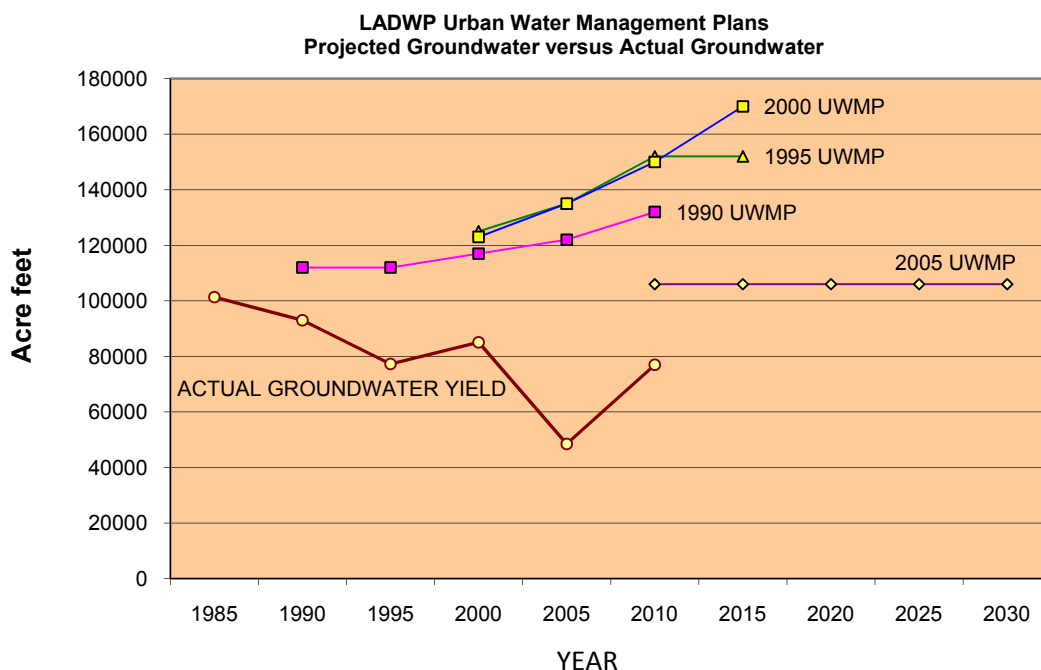


Figure 2 – This chart summarizes the groundwater projections from the past four urban water management plans (1990 through 2005) and compares them with actual groundwater pumped by the LADWP. The 1990 UWMP over-projected water supply by 51 percent for 2010, enough for 150,000 single family housing units.

**3. WATER SUPPLY ASSESSMENTS (Sec 11.4) – A SERIOUS DEPARTURE FROM THE PAST**

- a. The 2010 draft urban water management plan cites that “If the land use of the proposed development is consistent with the City’s General Plan, the projected water demand of the development is considered to be accounted for in the most recently adopted UWMP.”

In this section the 2010 draft UWMP is inconsistent with Section 10910 (c)(1), (2) & (3) of the California Water Code. Section 10910 requires a city or county to cite the “most recently adopted

urban water management plan”, not the General Plan as stated above when assessing the proposed water demand of a project.

**Section 10910(c)**

(1) The city or county, at the time it makes the determination required under Section 21080.1 of the Public Resources Code, shall request each public water system identified pursuant to subdivision (b) to determine whether the projected water demand associated with a proposed project was included as part of the **most recently adopted urban water management plan** adopted pursuant to Part 2.6 (commencing with Section 10610).

(2) If the projected water demand associated with the proposed project was accounted for **in the most recently adopted urban water management plan**, the public water system may incorporate the requested information **from the urban water management plan** in preparing the elements of the assessment required to comply with subdivisions (d), (e), (f), and (g).

(3) **If the projected water demand associated with the proposed project was not accounted for in the most recently adopted urban water management plan**, or the public water system has no urban water management plan, the water supply assessment for the project shall include a discussion with regard to whether the public water system's total projected water supplies available during normal, single dry, and multiple dry water years during a 20-year projection will meet the projected water demand associated with the proposed project, in addition to the public water system's existing and planned future uses, including agricultural and manufacturing uses.

This section in the 2010 UWMP is a serious departure of past water assessments (See figure 3). If left in place, all new water supply assessments performed over the next five years (or until a new general plan is adopted) will be referencing a water plan that is no longer the most recent plan, and a plan that seriously overstates the city's water supply.

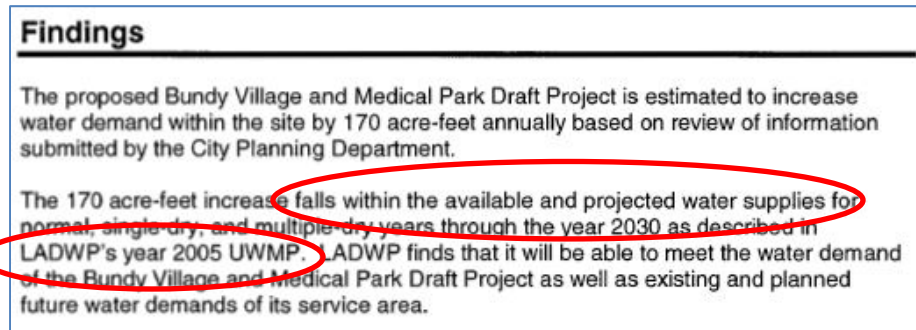


Figure 3 – Typical finding found in water assessments for developments within the LADWP service area.

b. The 2010 draft states that “The water demand forecast model in the UWMP was developed using LADWP total water use, including the water served by LADWP for use outside of the City.”

Given that demand has exceeded supply since the 1985 UWMP, the ‘demand forecast’ is no longer a useful model since it encourages drought conditions. The demand is based on population projections provided by the Southern California Association of Governments (SCAG) that encourage growth with reckless disregard to water supply. This model should be replaced with an annual water ‘supply forecast’ model that manages growth to avoid costly and damaging droughts.

#### 4. METROPOLITAN WATER DISTRICT (MWD)

a. The 2010 LADWP UWMP notes that “An important part of the water planning process is for LADWP to work collaboratively with MWD to ensure that anticipated water demands are incorporated into MWD’s long-term water resources development plan and water supply allocation plan. The City’s allotment of MWD water supplies under MWD’s water supply allocation plan is based on the City’s total water demand which includes services to areas outside the City.”

The City's allotment of MWD water is not based on the city's total water demand but instead on property tax assessments and the value of the investments it has with MWD infrastructure projects. Combined, those investments have earned LADWP the rights to about 20.8 percent of MWD water. The rest is split up among the MWD's twenty-five other member agencies.

The City's full contractual allotment of water from MWD would be approximately 511,000 AF of water annually which is about 20.8 percent of MWD's total annual inventory<sup>1</sup>.

However, the city's water annual allocation has been substantially limited because of *a*) legal restrictions caused by environmental over-commitment (damage caused to other regions of the state)<sup>2</sup>, *b*) the rights of other member agencies, agricultural interests, and the rights of other states<sup>3</sup>.

In 2007 the city received approximately 421,000 AF of water and in 2010 the city received only 262,538 despite increased demands.

David Coffin  
8430 Truxton Ave.  
Westchester, CA 90045

---

<sup>1</sup> Includes 1.91 million AF from State Water Project and 550,000 AF of Colorado River Aqueduct

<sup>2</sup> Sacramento Delta restrictions (Wanger 2007); LA/Inyo Long Term Water Agreement; State Water Resources Control Board issues decision 1631; 1997 LORP MOU Provisions.

<sup>3</sup> Sacramento Delta restrictions (Wanger 2007) and State of Arizona v. State of California 2006 Consolidated Decree.



March 9, 2011



Mr. Ronald Nichols  
General Manager and Chief Engineer  
Los Angeles Department of Water and Power  
111 North Hope Street, Room 1550  
Los Angeles, CA 90012

Dear Mr. Nichols:

Decentralized greywater and blackwater recycling have made a significant impact on the water supply in Sydney, Australia. Sydney Water, in collaboration with the state of New South Wales, has defined a goal to recycle 18 billion gallons of water per year by 2015 in the greater Sydney area. As of today, 78 greywater and blackwater projects are recycling and saving 8 billion gallons a year. Aside from the water savings, imagine the implications on the city's water and sewer systems – nothing short of dramatic.

The key ingredient to the progress in Sydney is the broad scale effort by Sydney Water. The utility recognized the potential for onsite greywater and blackwater recycling and has not only embraced, but encouraged the practice. Instead of leaving the green building movement to initiate comprehensive water conservation, Sydney Water decided to address water conservation at the source – their organization. Sydney Water understands they cannot do it alone and that promoting private decentralized recycling will make a more immediate impact on the water supply. I believe Los Angeles has the potential to make a similar impact with greywater and blackwater recycling – an impact that would serve current and future generations.

Upon reading the 2010 Los Angeles Urban Water Management Plan I find that it improperly addresses the potential for greywater and blackwater recycling. These topics should be a priority for the LADWP and I write this letter to ask that the Plan be revised to include funding dollars towards greywater and blackwater onsite reuse programs.

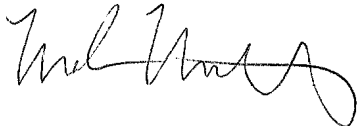
I also support the creation of ad hoc committees made up of manufacturers, consultants, engineers and experts in the field of onsite water recycling to begin work towards developing a standard for greywater and blackwater recycling in Los Angeles. Regulators and policymakers need to discuss and understand the benefits and challenges associated to implementing these solutions. For instance, where can this non-potable effluent make the most impact on water demands? Cooling towers, surface irrigation and toilet flushing are typically the heaviest water users and this is where the technology should be applied. Officials will also need to address the risks associated with onsite water recycling and this is where my firm can add significant value to the conversation.

My company, PHOENIX Process Equipment Co, has partnered with Aquacell, an industry leader in onsite water recycling in Australia, to usher in a safe and reliable solution for water recycling in the United States. Based on an integrated approach which includes consulting, installation, project management and operations of greywater and blackwater systems, Aquacell has a remarkable track record and serves as a great example how to properly implement this practice. Aquacell's success illustrates that if employed with care and risk management in mind, onsite water recycling can be safe and effective – all

while providing the inhabitants of the building something to be proud of. I should also testify that as of today, Aquacell has no reported health incidents as a result of their systems.

I hope you will consider the accounts outlined above as an impetus to engage greywater and blackwater recycling more seriously at LADWP. Please let me know if I can be of any service to LADWP as you begin to research and adopt this practice. PHOENIX and Aquacell would be delighted to partner and/or assist LADWP at any level deemed appropriate.

Sincerely,

A handwritten signature in black ink, appearing to read "Mark Meredith". The signature is fluid and cursive, with a large loop at the end.

Mark Meredith  
Product Manager, Aquacell

cc:

James McDaniel  
Simon Hsu

14 March 2011

Mr. Ronald Nichols  
General Manager and Chief Engineer  
Los Angeles Department of Water and Power  
111 North Hope Street, Room 1550  
Los Angeles, CA 90012

**Re: 2010 LA Urban Water Management Plan**

Dear Mr. Nichols,

I have read the 2010 Los Angeles Urban Water Management Plan and I believe it should be a priority to allocate more funding dollars towards greywater and blackwater onsite reuse programs in the plan. As green building initiatives such as LEED drive the building movement towards a more sustainable built environment, I believe LADWP has an opportunity to play a critical role in building a sustainable Los Angeles. By developing policies and a framework for onsite greywater and blackwater recycling, LADWP can take ownership of this significant water conservation measure and promote the use of these technologies to make a remarkable impact on the region's water supplies. A water crisis in Los Angeles will ultimately fall on the shoulders of LADWP, therefore I believe it is in the organization's best interest to promote water conservation measures such as onsite recycling to mitigate risks.

I support the creation of ad hoc committees made up of manufacturers, consultants, engineers and experts in the field of onsite water recycling to discuss the parameters and scope for developing a standard for greywater and blackwater recycling in Los Angeles.

My company, Aquacell, builds and operates water recycling plants for business, industry and government. Our focus is on non-potable (non-drinking) water for use in a variety of applications including surface irrigation, cooling tower makeup, clothes washing and toilet flushing. Aquacell's plants recycle greywater which is water discharged from showers, baths, basins and washing machines; and blackwater which is any water that has been contaminated with water discharged from a toilet.

Aquacell takes an integrated approach to water recycling plants including consulting, installation and project management for commercial and new residential developments. It also offers ongoing operations and maintenance agreements.

Aquacell staff has many years experience in the water industry and are very knowledgeable about each Australian state and territory's regulatory requirements. Our experience in Australia is that a properly structured regulatory framework can safely ensure decentralised recycled water systems, such as those we install in buildings and neighbourhoods can contribute in a major way to saving water and reducing hydraulic loading on water and sewer systems.



With such a depth of knowledge and successful track record implementing onsite water recycling, Aquacell would be eager to partner with LADWP and contribute to the development of a viable approach to recycling water in Los Angeles.

Yours sincerely,

Colin Fisher  
Managing Director

cc:  
James McDaniel  
Simon Hsu

14<sup>th</sup> March 2011

Mr. Ron Nichols  
General Manager & Chief Engineer  
Los Angeles Department of Water and Power  
111 North Hope Street, Room 1550  
Los Angeles, CA 90012

Dear Mr Nichols,

**RE: 2010 LA URBAN WATER MANAGEMENT PLAN**

I understand from reading the 2010 Los Angeles Urban Water Management Plan (LAUWMP) that the City of LA wants to establish a Water Management Framework that aims to reduce overall water demands for the city and improve Water Security. Obviously this will be a multi-prong approach given that water is primarily sourced from Los Angeles aqueducts, groundwater, and is imported with supplemental water purchases from MWD. We understand that Recycle water currently only contributes <1% of the total water supply.

The LAUWMP appears to look at Water Conservation mainly through pricing incentive schemes, improved water efficiency fixtures, and domestic graywater reuse, but hasn't realised the full potential that decentralised commercial graywater and blackwater systems can contribute to the City of LA's water management objectives.

Despite large scale recycling schemes being in place in LA since 1979 (when water was delivered to the Department of Recreation and Parks for irrigation of areas in Griffith), such centralised reuse schemes are limited to where they can be utilised by physical infrastructure constraints. Centralised systems typically only benefit very large scale water users (e.g. golf course, freeway irrigation), and then only those users who are also located directly next to where the distribution piping is built. Whilst significantly contributing to the city's overall Water security, developments that are located outside of the central recycled water distribution network are precluded from accessing the water saving benefits that a centralised reuse scheme provides.

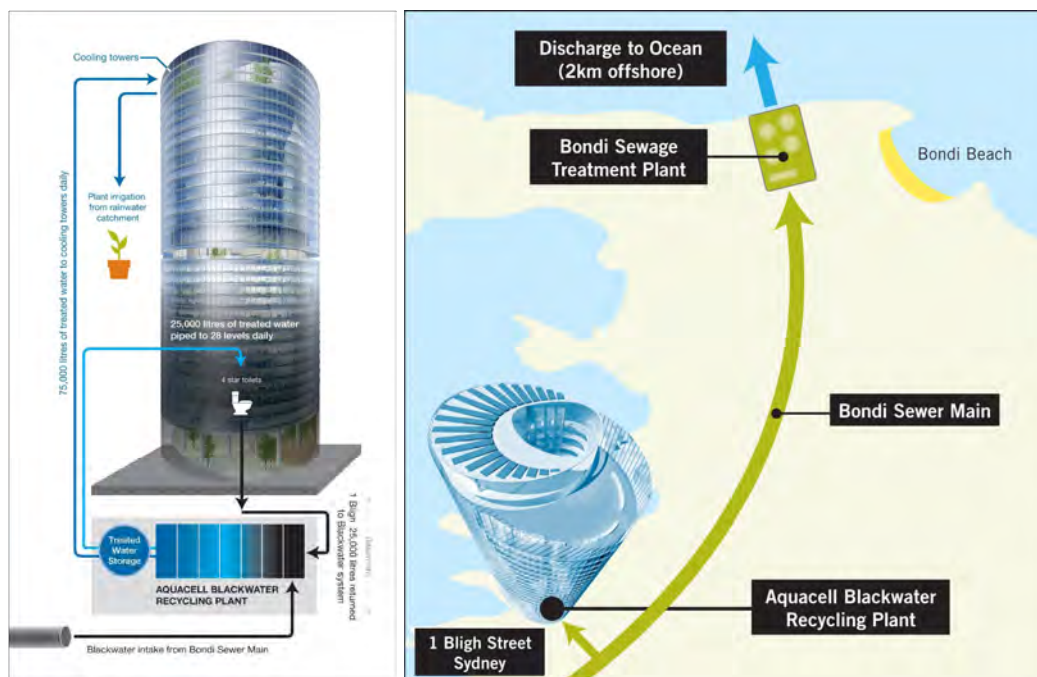
Medium scale decentralised Plants (e.g. 15,000 – 100,000 gallons / day Plants) have an opportunity to afford a high level of flexibility to implement reuse schemes across a wider area of LA City than what current or future centralised systems offers, whilst being large enough to meet the costs associated with maintaining and demonstrating that public health risks are appropriately managed. Broadly speaking, decentralised graywater systems that manage the total water balance of a site can reduce on-site water demand/wastewater production by 30-50%, and blackwater reuse system can reduce on-site water demand/wastewater production by 70-90%. Developments that currently have significant water demands either through surface irrigation (e.g. any development with a sports fields, city or precinct gardens) or cooling towers are major candidates for decentralised systems because of their localised high water demands.



Aquacell is an Australian company that specialises in commercial graywater and blackwater reuse systems. We have both blackwater and greywater systems which have been operating for a number of years that can demonstrate what can be achieved. With more and more decentralised schemes coming on line in Australia, reuse is becoming more widely accepted and consequently the interest is growing. The main project drivers why facilities look at decentralised reuse schemes cover a range of reasons, including: regulatory or development approval requirements, sourcing alternative water sources (e.g. to add to available water sources), green or environmental marketing, infrastructure solutions (either no sewer or sewer at limited capacity).

To demonstrate what can be done with decentralised schemes, I have attached an Aquacell case study of a 25,000 gallon a day blackwater reuse Plant that we have had operational for the last 5 years at a sports club in Western Sydney. The site treats blackwater generated from the site and uses it for surface irrigation of the sports fields. In addition to water saving measures, the site has also reduced fertiliser use by 30-50% due to the available nutrients in the effluent – another non-water environmental benefit. Note that nutrient removal can be done at other sites if required.

In addition to this, I show some schematically pictures below of a Blackwater to cooling tower system that Aquacell is in the final stages of project implementation – practical completion due May 2011. In this project, we are collecting 100% of the blackwater from a CBD building in Sydney (6,600 gal/day), plus drawing in an extra 25,000 gallon per day from the main Sydney sewer to reuse the effluent in the buildings cooling tower. Although technology for such schemes has existed for a number of years, the reason why this project can be considered in Sydney is because the regulatory framework is in place to allow it to legally occur.





We see that the key to tapping into the very significant potential that decentralised reuse Plants can offer, starts with the development of a LA city blueprint standard for graywater and blackwater reuse. It is important that this standard gets the right balance between protecting public health and also being commercially realistic. In Australia, Aquacell has seen a range of regulatory positions; some being too lax that let systems get through the cracks which perhaps haven't been fully scrutinised, while other regulations are driven too much by bureaucrats and academics and have subsequently imposed such unrealistic expectations on reuse systems that they become commercially inhibitive below any scheme less than 250,000 gallon per day. It therefore is important that when Standards for blackwater and graywater reuse are developed for LA City, they are done so by an ad hoc committee that is able to bring a range of expertise and perspectives to the table. This should not only include law makers, but also public health experts, commercial representatives that could benefit from implementing these systems (e.g. developers or facility owners), consultants and people with prior experience in operating decentralised reuse schemes.

I would be more than happy to share our experience in Australia with LA City to ensure that it steps forward with a pragmatic and protective Standard, which establishes a template for effectively and safely implementing reuse opportunities throughout the city of LA. Please don't hesitate to call or email if you require further information.

Sincerely

**Ian Kikkert**  
*Business Development Engineer*  
m) +61 (0)409 018 383  
e) [iank@aquacell.com.au](mailto:iank@aquacell.com.au)



1444 9th Street  
Santa Monica CA 90401

ph 310 451 1550  
fax 310 496 1902

info@healthebay.org  
www.healthebay.org

March 15, 2010

Attn: Simon Hsu  
LADWP--Water System  
111 N. Hope St. Room 1460  
Los Angeles, CA 90012

**Re: Draft 2010 Urban Water Management Plan**

Dear Mr. Simon Hsu:

On behalf of Heal the Bay, we submit these comments regarding the City of Los Angeles Department of Water and Power Draft 2010 Urban Water Management Plan (“Plan” or “Draft UWMP”). We appreciate the opportunity to provide these comments.

There are many aspects of the Draft UWMP that we support. For instance, we agree with LADWP’s prioritization of expanded water conservation and water recycling over the use of desalination to provide additional water supply. Heal the Bay supports the expansion of LADWP’s recycled water system and the commitment to move towards a more sustainable water supply. However, we do have a few concerns with the Plan as drafted. LADWP should revert to a more ambitious goal for expanding recycled water use, provide additional support for stormwater capture, and investigate direct and indirect potable use of advanced treated water as a supply alternative. These and other concerns and suggestions are expressed below.

**LADWP should set more aggressive goals for water recycling.**

The goals the Draft UWMP sets for expanding recycled water use are not ambitious enough given the present condition of our current water supply and the available source water from POTWs. In fact, the goals provided are a major step backwards from previously set goals. The Draft UWMP states that LADWP has the goal of replacing 50,000 AFY of potable water with recycled water by 2029. When Heal the Bay began participation on the Recycled Water Advisory Task Force in 2009, the stated goal was “to produce 50,000 acre-feet of recycled water by 2019.” Another stated action was to “pursue options to maximize recycling beyond 50,000 AFY.” Of note, several members of RWAG held that we should look beyond this goal and increase the new recycling opportunities to 100,000 AFY by 2019. The revised goal stated in the Draft UWMP takes a major step backwards. Compounding this concern is the fact that LADWP has not met the goals set in the 2005 Urban Water Management Plan for recycled water usage, as noted in the Draft UWMP.





1444 9th Street  
Santa Monica CA 90401

ph 310 451 1550  
fax 310 496 1902

info@healthebay.org  
www.healthebay.org

LADWP should prioritize expanding demand and delivery of recycled water. The four major treatment plants operated by Los Angeles BOS produce enough treated water to allow for much more aggressive recycled water goals than are presented within this document. According to the draft, Los Angeles used approximately 550,000 acre-feet of water last year, and around half of that volume was imported through MWD (Draft UWMP Exhibit 1F). Los Angeles-Glendale, Donald C. Tillman, Terminal Island, and Hyperion Water Reclamation Plants combined produce an average of around 460,000 AFY. Utilizing recycled water in our region to the fullest extent could greatly reduce our reliance on imported water in Los Angeles. This is a crucial step toward a sustainable water future. It is critical that we use local reliable water, such as recycled water that would otherwise be discharged to the ocean, to offset the demand for imported water supplies as soon as possible. Thus, the Draft UWMP should be modified to, at a minimum, return to the more ambitious goal of 50,000 AFY of new recycled water usage by 2019. We urge LADWP to look beyond this initial goal and plan for 100,000 AFY by 2019.

**LADWP should prioritize stormwater capture projects and set goals for new stormwater capture projects in Los Angeles.**

Stormwater must be used as a resource in order for Los Angeles to achieve a sustainable water supply. Using stormwater as a water source requires less energy and results in far fewer environmental impacts than many other sources of water such as desalination and water importation. Stormwater proves to be a much more sustainable, cost-effective local water resource than desalinated water, yet no incentives are provided in the Draft UWMP for its capture and use throughout the region. We strongly encourage LADWP to create a policy that provides economic incentives for stormwater recharge and reuse projects. Further, the Plan should establish a goal for increased stormwater capture in Los Angeles. At a minimum, LADWP should set a goal of an additional 50,000 AFY by 2020 for stormwater capture projects. The Tujunga Spreading Grounds alone currently capture 8,000 AFY, with plans to expand to 16,000 AFY and the potential to capture 50,000 AFY, so we believe this is a realistic goal.

There are also opportunities for stormwater capture at the individual lot scale. In Section 7.6 (Distributed Stormwater Capture), the Draft UWMP highlights that “Installation of rain barrels at residences throughout Los Angeles... could potentially capture 6,400 AFY...” As you know, the City of Los Angeles had a very successful rain barrel pilot project. This would be a great program for LADWP to help fund and take city-wide. We also urge LADWP’s continued support for the Low Impact Development Ordinance, which the City of Los Angeles is in the process of adopting. This ordinance will go a long way in using stormwater as a resource.

The Draft UWMP mentions that LADWP is partnering with Los Angeles City Department of Public Works, Los Angeles County Department of Public Works, and Treepeople Inc. to draft a Stormwater Capture Master Plan. When will the Stormwater Capture Master Plan be completed? Will it be released to the public for review? The Draft UWMP should discuss these goals in more detail and involve additional stakeholders in this effort.



1444 9th Street  
Santa Monica CA 90401

ph 310 451 1550  
fax 310 496 1902

info@healthebay.org  
www.healthebay.org

### **LADWP should actively increase water conservation measures**

In the Draft UWMP, LADWP sets a water conservation goal of 50,000 AFY by 2019. In terms of conservation, the City has moved in the right direction, but there is more that can be done to provide conservation incentives. In addition to the measures mentioned in the Plan, LADWP should require that all public buildings get retrofitted with waterless urinals and other ultra-efficient conservation devices. New high-use visitor-serving commercial properties should be required to install these devices as well. In addition, LADWP should offer incentives for graywater treatment and reuse systems. Also, LADWP should push for the city to develop a landscape conservation ordinance that weans Los Angeles off of the use of thirsty non-native plants and requires the use of natives or xeriscape plants. Finally, water pricing needs to be more equitable city-wide and provide greater incentives to conserve.

### **LADWP should investigate reclaimed water purification as a water supply alternative in the future.**

The Draft UWMP mentions that in 2002 LADWP identified Scattergood Generating Station as a potential site for a seawater desalination plant. While we support the fact that LADWP's current water resource strategy does not include seawater desalination as water supply due to environmental and cost considerations, we are concerned that this option is still being considered for future supply while there are still water saving projects that are "lower-hanging fruit". Before exploring seawater desalination as an option for water supply, LADWP should aggressively explore stormwater capture and water recycling as discussed above. In addition, LADWP should explore advanced wastewater treatment for future indirect or even direct potable use. Hyperion Treatment Plant, for example, produces nearly 360,000 AFY, most of which is discharged directly to the ocean. If this water were utilized, it would offset a significant portion of the freshwater needed in Los Angeles. Wastewater purification takes about a quarter of the energy that seawater desalination requires, strictly looking at thermodynamic considerations, and would not have as many negative environmental impacts as seawater desalination. This type of project has seen great success in other areas. The benefits and constraints of advanced wastewater treatment through reverse osmosis and microfiltration should be considered in the Draft UWMP.

If LADWP does pursue research of seawater desalination as a potential water supply, LADWP should focus on the least environmentally harmful types of desalination, such as subsurface cooling intakes, desalination of brackish water, or desalting Hyperion effluent in order to avoid some of the negative impacts of seawater desalination on marine life and energy usage. Several desalination proposals in California rely on co-locating with once-through cooled power plants, causing impingement and entrainment of marine life. Researching alternative forms of desalination to co-location with once-through cooled power plants would help inform future water supply technologies that pose a lower threat to marine life and are less energy intensive.



1444 9th Street  
Santa Monica CA 90401

ph 310 451 1550  
fax 310 496 1902

info@healthebay.org  
www.healthebay.org

**LADWP should provide further support for LAUSD to achieve the goals set forth in the LAUSD Water Savings Resolution.**

Los Angeles Unified School District (LAUSD) is one of the largest water consumers in the county. This past December, the LAUSD School Board passed a Water Savings Resolution with extremely ambitious goals for water conservation, water efficiency, and the offset of potable water with recycled water resources. LAUSD resolved to utilize recycled water, where available within one-half mile from the local utility distribution source, for irrigation and in urinals and toilets. In addition to providing financial incentives for every retrofit and for every new zero-water urinal and high efficiency toilet used in a new construction project, LADWP should provide incentives for new fixtures in redevelopment and retrofit projects as well. In addition to these rebates, LADWP should consider expanding the purple pipe system to LAUSD schools.

To summarize, LADWP should set more aggressive goals for water recycling and stormwater capture, provide more support for widespread implementation of LID and Stormwater capture projects throughout Los Angeles, investigate reclaimed water purification for future as a water supply alternative, and provide further support for LAUSD to achieve the goals set forth in the LAUSD Water Savings Resolution. Thank you for your consideration of these comments. If you have any questions, please contact us at (310) 451-1500.

Sincerely,

Kirsten James, MESM  
Water Quality Director

W. Susie Santilena, MS, E.I.T.  
Water Quality Scientist

Comments to LADWP Draft 2010 Urban Water Management Plan due 3.15.2011

The **Population, Housing and Employment** history (1980) and projected (2035) shows increases of the following:

Total Population: 1,497,560 or 50.42%

Total Housing: 543,947 or 49.45%

Total Employment: 320,664 or 18.95%

In reference to “**Securing L.A.’s Water Supply**,” you state:

“By 2028, the Plan envisioned a six-fold increase in recycled water supplies to a total of 50,000 AFY.

Similarly, by 2030, an increase of 50,000 AFY was planned for conservation. As described in the Plan, this aggressive approach included: investments in state-of-the-art technology; a combination of rebates and incentives; efficient clothes washers, and urinals; and long-term measures such as expansion of water recycling and remediating contaminated groundwater supplies. . A multi-faceted approach to developing a locally sustainable water supply was developed incorporating the following key short-term and long-term strategies:

#### Short-Term Conservation Strategies

- Enforcing prohibited uses of water
- Expanding prohibited uses of water
- Extending outreach efforts
- Encouraging regional conservation measures
  
- Long-Term Strategies
- Increasing water conservation through reduction of outdoor water use and new technology
- Maximizing water recycling
- Enhancing stormwater capture
- Accelerating groundwater basin clean-up
- Expanding groundwater storage
- Green Building Initiatives (added subsequent to the release of the Plan)”

**Land Use**, on the other hand is:

Single Family Dwellings: 121,470 acres of 40.2%

Other including specific plans, transportation, freeways, rights of way and other miscellaneous uses that are not zoned: 52,806 or 17.48%

Open Space/Parks: 40,263 acres or 13.32%

Multi-Family Dwellings: 34,189 acres or 11.31%

Commercial includes public facilities, libraries, public schools and government facilities: 30,083 acres or 9.96%

Manufacturing: 23,353 acres or 7.73%

**Historical Water Demand** has been **reduced**, on average from the 1986-1990 to the 2005-2010 periods:

Single Family Dwellings: 2,094 AF or 0.88%

Multifamily Dwellings: 17,033 AF or 8.63%

Commercial: 16,369 AF or 13.27%

Industrial: 7,301 AF or 23.94%

Government: 438 AF or 1.01%

Non-Revenue: 20,901 AF or 39.56%

Overall: 64,136 AF or 9.35%

You conclude that **outdoor water use** is estimated at 39% of demand, yet the usage above does not indicate a reason to come to that conclusion. In fact, non-revenue almost matches that 30% outdoor demand. What is the definition of non-revenue, city usage?

Your **2035 estimates** exceed the **2005-2010 Average usage** except in Industrial passive, Industrial passive and active; and Commercial/Government passive and active:

Single Family:

2005-2010: 236,154 AF

2035 Passive: 259,904 AF

2035 Passive and Active: 247,655 AF

Multifamily:

2005-2010: 180,279 AF

2035 Passive: 221,912 AF

2035 Passive and Active: 218,762 AF

Commercial/Government:

2005-2010: 149,895 AF  
2035 Passive: 160,049 AF  
2035 Passive and Active: 120,420 AF

Industrial:

2005-2010: 23,201 AF  
2035 Passive: 19,852 AF  
2035 Passive and Active: 10,513 AF

Non-Revenue:

2005-2010: 31,929 AF  
2035 Passive: 49,042 AF  
2035 Passive and Active: 44,272 AF

You need to compare these with the Baseline Per Capita Use to see if compliance can be obtained for the 20 X 2020. Those calculations are not included in this draft.

**Conservation** should not be used as a category of source. It is a method of reduction, so 9.05% needs to be replaced by source usage.

**Industrial** and **Manufacturing** bases need to be placed in reality. Is there an overall reduction of businesses with no future growth, or is growth planned in the manufacturing arena with more demand to be placed.

This plan needs to be overlaid with the LA Power Plan for consistency of forecasting. Both plans need to be consistent with the General Plan.

## **Recycled Water**

You state:

“These include expanding the recycled water distribution system for Non-Potable Reuse (NPR) such as for irrigation and industrial use, along with replenishment of groundwater basins with highly purified recycled water. Beyond 50,000 AFY, LADWP expects to increase recycled water use by approximately 1,500 AFY annually, bringing the total to 59,000 AFY by 2035.”

There are several problems here.

Recycled water needs to be treated for use. So far, these water cannot be sold to water down dust on horse ranches, yet you only consider irrigation usage.

Purple pipe is a capital expense limited to age of existing infrastructure, homes and subject to gravity for delivery.

Tanks and underground storage need to be addressed. There are legal issues with underground storage of groundwater in an adjudicated basin. Nothing is mentioned of the lawsuit against the **Water Replenishment District** regarding groundwater rights extraction and the Storage Framework in the Central Basin. The Storage Framework was not allowed.

Nothing is mentioned of West Basin and recycled water processing or of **CeLAC** Central Los Angeles County Regional Recycled Water Project.

Nothing is mentioned of the **2009-2010 Grand Jury Report** or the County's answer. There has been no City of Los Angeles response. The Grand Jury notes discrepancies with charts supplied.

**Storm water runoff** and **urban water runoff** is under the jurisdiction of the County of Los Angeles and the Los Angeles County Flood Control District. Runoff is not an asset of the City, the Bureau of Sanitation or the LADWP. We are attaching the United States Court of Appeals Ninth Circuit Opinion No. 10-56017 in a recent case involving the County of Los Angeles ETAL.

The assumption in this document is that the Bureau of Sanitation can partner with LADWP. Only LADWP can have possession, management and control of water and water rights, lands and facilities and can capture, transport, distribute and deliver water for the benefit of the City, its inhabitants and its customers.

**Non adjudicated groundwater basins** such as the Santa Monica Basin and the Hollywood Basin are not addressed. There are no groundwater extraction rights and storage would probably be applicable to the individual property owner.

**Groundwater replenishments projects** in the San Fernando Valley are part of the Greater Los Angeles County Integrated Regional Water Management Plan under the jurisdiction of the State Department of Water Resources.

**Greater Los Angeles County Integrated Regional Water Management Plan** shows the Metropolitan Water District Integrated Resource Plan Supply Targets and proportion of targets. There is no reconciliation in this report to the LADWP portion of those targets in all categories.

**Overall**, this report touches on aspects of water, but does not address the complexities of supply and demand in a realistic sense. Growth is evident without supply considerations and cost (demand). Green Building is so minimal, it should not even be considered as a method. Recycled water is not a reliable source at this point in time.

Capital costs and operation and maintenance funding are not addressed properly.

This leaves the inhabitants and customers in the City of Los Angeles at risk financially, in public health and safety issues and quality of life issues.

Joyce Dillard  
P.O. Box 31377  
Los Angeles, CA 90031

Attachment: Opinion No. 10-56017





March 13, 2011

To: Ronald O. Nichols, General Mgr. & Chief Engineer WP

First, let me congratulate you on your appointment as General Manager of the DWP. I, along with my fellow ASPE members look forward to your aggressive and far reaching plans for the City of Los Angeles.

I have had the opportunity to attend several DWP workshops in regards to the proposed 2010 Urban Water Management Plan and I applaud the efforts of the DWP to address the upcoming water shortage issues that face the Southern California region.

It goes without exception that we are facing issues that mirror the energy crisis that was addressed decades ago. That crisis forced the public and the industry to address fuel economy and most recently alternative power sources.

In reviewing the proposed plan, the issues of Graywater, Rainwater Harvesting and Stormwater Management I feel are areas that can be readily obtainable and cost effective. There are already Graywater systems being used not only worldwide, in particular Australia, but in the City of New York there is an existing commercial/residential application installed. The technology for Graywater, Rainwater Harvesting already exist meaning that the "wheel doesn't have to be re-invented" There are major Universities involved with these technologies, in particular UCLA and UC Davis.

The Water Purveyors and Utility Companies such as LADWP should develop a strategic plan to convince policy makers and building officials to accept these types of technological innovations which already have a successful track record in Australia.

Like any game changing effort, this will be a herculean task. That being said, rather than grinding slowly toward a solution, I propose that an ad-hoc committee be formed consisting of engineers, manufactures, contractors, university experts and DWP personnel to add to the Urban Plan specifically in these three areas with the mandate that a workable plan and technologies to go with it be presented for DWP review within the next 180 days. As a member of the industry that addresses these issues, I would be happy to serve on such a committee.

The recent tragedy in Japan is an example of how a catastrophe can affect both the water and power delivery when it is most needed.

I am enclosing separate sheets of industry professional signatures that likewise share my enthusiasm and concern for this task at hand. They represent members of the Los Angeles Chapter of ASPE.

Sincerely,

Bob Pehrson



15070 Proctor Ave., City of Industry, CA 91746 626/333-9942 Fax/855-4811  
9750 Birch Canyon Place, San Diego, CA 92126 858/437-0112 Fax/437-0117

---

Elmco/Duddy  
rmpapex@msn.com

cc: James B Mc Daniel, Simon Hsu, Ms. Lorraine Paskett, Thomas Gackstetter, Thomas Erb,  
Dr. Parekh Pankaj, Amir Tabakh, Michael Benisek



March 15, 2010

Attn: Simon Hsu  
LADWP – Water System  
111 N. Hope St, Room 1460  
Los Angeles, CA 90012

**Re. Recommended Amendments to Urban Water Management Plan 2010: Chapter Four**

Dear Mr. Hsu:

Environment Now submits the following comments to Los Angeles Department of Water & Power (LADWP) on its 2010 Urban Water Management Plan (UWMP). Environment Now (EN) is an independent, non-partisan, non-profit organization, founded in 1989. EN's mission is to be an active leader in creating measurably effective environmental programs to protect and restore California's environment.

Thank you for this opportunity to comment on the UWMP. California's water supply is becoming increasingly vulnerable as our population grows and landscape dries. To meet the challenges of our heightened demands and diminished supply, EN has supported the diversification of water supplies. EN has worked with water providers and clean water advocates to establish regulations that will bring millions of acre-feet of recycled water on-line—including reclaimed wastewater, captured stormwater, and recharged groundwater basins.

EN has been committed to helping LADWP reach water re-use targets since 2006. We formed partnerships between LADWP staff and community leaders to promote reclaimed water by addressing permitting concerns. In 2007, we formed the State Water Resources Control Board's stakeholder group including LADWP staff to draft the state's first "Recycled Water Policy." In 2008, we also worked with LADWP to host community workshops in order to allay concerns about the "toilet to tap" campaign. In 2009, we worked with LADWP to reconcile their Recycled Water Master Plan with 2005 and 2008 benchmarks. In 2010, we participated in the Recycled Water Advisory Group and supported the staff's plans to reach benchmarks with ongoing rate dedication to "environmental" projects such as recycled water.

The commitment to reclaimed water from community leaders and LADWP staff has been unwavering. For this reason, we are surprised to see rollbacks in the 2010 UWMP water re-use benchmarks. In its 2005 UWMP, LADWP forecasted 16,000 AFY by 2010 and 30,000 AFY by 2030. In 2008 the City of LA promised 50,000 AFY of reclaimed water by 2019 and 100,000 AFY by 2030. Unfortunately, LADWP appears to be plagued with rollbacks. Regardless of the community support and staff expertise, the agency has only met half its original benchmark with 8,000 AFY of reclaimed water on-line today. Now the 2010 UWMP projects a total of 59,000 AFY by 2035. This is considerably below its 2005 and 2008 benchmarks.

LADWP has considerable resources on which to draw for increased reclaimed water supplies. In addition to upgrading the Tillman Plant by 15,000 AFY, the Terminal Island plant could be expanded to 12,000 AFY with an additional 20,000 AFY transferred for treatment from Hyperion. Further, the L.A.-Glendale Plant tertiary water could be distributed for irrigation use rather than discharged into the LA River. Moreover, Hyperion remains a tremendous resource for nearly half-a-million AFY of reclaimed water if only it were upgraded. Even without Hyperion, the potential capacity for existing reclamation facilities is higher than the 2010 UWMP benchmark.

EN has provided comments regarding commitments and financing for reclaimed water on many occasions. Most recently, we provided verbal comments to General Manager, Ron Nichols, and staff on February 10, 2010. We do not see our comments reflected in your recent comment responses (published at: <https://www.piersystem.com/go/doc/1643/992207/>) To secure our comments are included and addressed, we are submitting these written comments.

Thank you again for this opportunity to comment on LADWP's 2010 UWMP. We look forward to working with the LADWP staff to implement these important reclaimed water plans and, ultimately, make the City of Los Angeles' water supply more reliable. If we can provide further research or comments please do not hesitate to contact us, [cmandelbaum@environmentnow.org](mailto:cmandelbaum@environmentnow.org), 310-829-5568\*241

Sincerely,



Caryn Mandelbaum  
Freshwater Program Director



March 15, 2011

Los Angeles Department of Water and Power  
111 N. Hope St  
Los Angeles, CA 90012

To: Chris Repp, and Simon Hsu  
Cc: Thomas Erb  
RE: Urban Water Management Plan, 2010 Comments

Thank you for the opportunity to submit comments on the LADWP Draft Urban Water Management Plan, 2010. Should you have any questions about our comments and recommendations, feel free to call or email.

Sincerely,

A handwritten signature in cursive script that reads "Rebecca Drayse".

Rebecca Drayse  
Director, Natural Urban Systems Group

TreePeople comments and recommendations on the Draft 2010 Urban Water Management Plan dated January 14, 2011

## Chapter 2

- **2-9, Exhibit 2I** - Although we applaud LADWP's leadership in water conservation, we believe much greater water savings can be obtained and will be necessary to meet future local water needs. We believe that LADWP should continue to lead by setting conservation targets that well exceed the minimum 20 x 2020 state mandated goals. Exhibit 2I appears to assume no new innovation or transformation will take place beyond 2015.

## Chapter 3

- **3-16 to 3-18:** As residential outdoor water use (for irrigation needs) accounts for the bulk of water use, LADWP should create a stronger and more concerted public campaign focused on landscape transformation (turf to native, or climate appropriate landscaping). Most of the conservation savings have so far been seen in incorporating efficient technologies, however a greater savings can be had in embracing a new landscape ethic.
- **3-22, final paragraph** – Revise sentence to better reflect Watershed Council's leadership in the Elmer Avenue project. Suggested language: **“Most recently TreePeople, LADWP, and other state and federal agencies partnered on an effort led by the Los Angeles and San Gabriel Rivers Watershed Council, to retrofit an entire residential block on Elmer Avenue in Sun Valley.”**
- **3-26:** Identify next steps necessary for incorporating graywater systems into LADWP conservation programs.

## Chapter 6

- **6-1, Section 6.1:** Explore opportunities to receive credit for additional stormwater recharge in the San Fernando Basin, particularly if large scale decentralized stormwater infiltration strategies are employed.

## Chapter 7

- **7-10** references **“Exhibit 7D”** which “summarizes the potential water yield and average unit cost of the different resources available to increase localized capture and infiltration of runoff”. It is missing from the document. Is the cost table in **“Exhibit 7H”** the proper reference here?

- **7-17 and Exhibit 7H:** We recommend updating cost table (Exhibit H) according to the new figures TreePeople provided for internal review under separate cover. Update text in 7-17 to reflect new figures in Exhibit H.
- **7-22, Section 7.6.5 Future Distributed Stormwater Programs:** Add rain gardens to the list of potential rebates (TreePeople is beginning a pilot rain garden rebate program with the Watershed Management Group).
- **From 7-24 (revise language):** “Furthermore, distributed stormwater capture projects yield additional benefits to the public outside of water supply generation such as flood control, restored native habitat, community beautification, public right of way improvements, water conservation, as well as private residence safety and aesthetic improvements.”
- **General:** Revisit the projected stormwater capture estimates as the Stormwater Master Plan is finalized and new targets are established. We believe that significantly more than **25,000 acre feet per year** can be captured by **2035**.

## Chapter 11

- **11-8, Exhibit 11E:** Note 1 indicates a loss in the LA Aqueduct at 0.1652% per year due to climate change. There is no indication of loss from MWD (California Aqueduct, and Colorado River Aqueducts) due to climate change. Does this account for MWD’s projections?
- **Chapter 11, Exhibits 11E to 11L:** Targets for stormwater capture stay consistent at 25,000 AF for both dry and normal years. Can this be revised?

## General

- Coordinate and package conservation, rainwater harvesting, low impact development, and graywater incentive programs to customers who implement these strategies. This will decrease implementation costs for these programs and increase consumer awareness of steps they can take to manage water supply.
- Replace “**drought tolerant**” with “**climate appropriate**” throughout the document. Climate appropriate is becoming the more accepted description for landscape transformation.
- Please replace “**Tree People**” with “**TreePeople**” (without a space) where referenced including the Table of Contents.

## Comments on 2010 Urban Water Management Plan

From: Conner Everts  
Southern California Watershed Alliance

To: Tom Urb, Simon Hsu  
LADWP

After reviewing your draft 2010 Urban Water Management Plan, attending your public workshops while making comments there, I just have a few final thoughts that I hope you will accept.

While I find this Urban Water Management Plan a vast improvement over past plans that I have commented on there are a couple of places where I think you do not give yourself enough credit. That is specifically the projections of per capita water use into the future, which is expressed in household use in Exhibit 2I on page 2-9 and Exhibit 2J with CII worked in and finally Exhibit 2K. While projection of conservation savings go up the demand seems to rise gradually until 2035. If you take the historic savings in the last few years and combine that with future investments why would demand continue to drop? La has that history and population has not been shown to 1) Be equal to SCAG or Department of Finance numbers or 2) mean increases of consumption.

This leads me to question why, on page 3-5, you chose Method 3 for reporting, when you are already at 19%. If current gpd is 124 by taking this approach you are actually looking at a higher per capita into the future. Other cities are taking a more aggressive approach, like Long Beach, which is about to reach 100 gpd, and therefore assuring the city of a full allocation under MWD's water shortage plan which then comes a real reliability factor. I believe that this should be discussed, as required, at a separate workshop.

There is an opportunity to make this a real planning tool for future water supply and inclusion of greywater, watershed management with stormwater, the City of LA's IRP make this plan very different. Inclusion and reference of LID and smart streets and the River Project's Tujunga Watershed plan would be helpful. Given that the 2020 Water Supply Plan does not list desalination, the historical list of past planning on the issue is confusing and leads one to believe that there are plans to move forward.

I wanted to attend the SCWC workshop last Friday at MWD and got this language:

**10608.26. (a) In complying with this part, an urban retail water supplier shall conduct at least one public hearing to accomplish all of the following:**

- (1) Allow community input regarding the urban retail water supplier's implementation plan for complying with this part.**
- (2) Consider the economic impacts of the urban retail water supplier's implementation plan for complying with this part.**
- (3) Adopt a method, pursuant to subdivision (b) of Section 10608.20,**



**for determining its urban water use target.**

We just interpreted this to mean that this public input should take place prior to when the UWMP is finalized, otherwise, if the public input takes place at the same time the plan is adopted, that input is pretty meaningless.

On another note, my fellow environmentalists and I have concerns with the direction and facilitation of the RWAG. We will attend the public workshops in support, like San Pedro this week but would like to talk about how we move forward. Lastly, the movement of AB 1180 is causing greater concern.

Again, thanks for your consideration and I am available if you want to talk about it.

Conner Everts



## References



# Urban Water Management Plan for the Los Angeles Department of Water and Power References

Cayan, Dan. "Climate Change – What Should Southern California Prepare For?". *Climate Change and the Future of Southern California*. Prepared by Southern California Association of Governments. July 2009.

Department of Water Resources. *California Water Plan Update Bulletin 160-09, Public Review Draft*. Vols. 1 -3. Retrieved March 30, 2010.  
[http://www.waterplan.water.ca.gov/docs/cwpu2009/0310final/v1\\_all\\_cwp2009.pdf](http://www.waterplan.water.ca.gov/docs/cwpu2009/0310final/v1_all_cwp2009.pdf)

California Irrigation Information Management Information System, Department of Water Resources, Office of Water Use Efficiency. Glendale, Hollywood Hills, and Long Beach ETO Station Data. Retrieved September 23, 2009.  
<http://www.cimis.water.ca.gov>.

California Sustainability Alliance. *The Role of Recycled Water in Energy Efficiency and Greenhouse Gas Reduction*. May 2008.  
[http://sustainca.org/newsroom/recycled\\_water\\_news](http://sustainca.org/newsroom/recycled_water_news).

California Urban Water Conservation Council. *Memorandum of Understanding Regarding Urban Water Conservation in California*. June 9, 2010.

California Urban Water Agencies. *Long-term Water Conservation and Shortage Management Practices; Planning That Included Demand Hardening*. June 1994. Retrieved August 10, 2005.  
<http://www.cuwa.org/library/LongTermWaterConversation.pdf>

Department of Water Resources. *Model Water Efficient Landscape Ordinance*. September 2009.  
<http://www.water.ca.gov/wateruseefficiency/landscapeordinance/>.

Department of Water Resources. *State Water Project Delivery Reliability Report 2009*.  
<http://baydeltaoffice.water.ca.gov/swpreliability/>.

Department of Water Resources. *Watermaster Service in the Central Basin, Los Angeles County, July 1, 2009 – June 30, 2010*. October 2010.

Department of Water Resources. *Watermaster Service in the West Coast Basin, Los Angeles County, July 1, 2009 – June 30, 2010*. September 2010.

Department of Water Resources. *Using Future Climate Projections to Support Water Resources Decision Making in California*. April 2009.  
[http://www.water.ca.gov/pubs/climate/using\\_future\\_climate\\_projections\\_to\\_support\\_water\\_resources\\_decision\\_making\\_in\\_california/usingfutureclimateprojtosuppwater\\_jun09\\_web.pdf](http://www.water.ca.gov/pubs/climate/using_future_climate_projections_to_support_water_resources_decision_making_in_california/usingfutureclimateprojtosuppwater_jun09_web.pdf)

Department of Water Resources and University of California Cooperative Extension. *A Guide to Estimating Irrigation Water Needs of Landscape Plantings in California*. August 2000.

Hayhoe, Katharine; Daniel Cayan and et. al. "Emission Pathways, Climate Change, and Impacts on California". *Proceedings of the National Academy of Sciences in the United States of America*. Vol. 101, No. 34. August 16, 2004.

James M. Montgomery, Inc. *Remedial Investigation of Groundwater Contamination in the San Fernando Valley*. December 1992

Long Beach Water Department. *Long Beach Water Department: Report on Findings from Evaluation of 2-Pass Nanofiltration and RO Processes Conducted at the Prototype Seawater Testing Facility*. October 2010. [https://www.lbwd-desal.org/presentations/USBR%20Final%20Report\\_10062010.pdf](https://www.lbwd-desal.org/presentations/USBR%20Final%20Report_10062010.pdf)

Los Angeles City Department of Public Works. *L.A. Rainwater Harvesting Program*. 2000. <http://larainwaterharvesting.org/>.

Los Angeles City Department of Water and Power. *Scattergood Generation Station Seawater Desalination Pilot Project*. March 2008. <http://www.ladwp.com/ladwp/cms/ladwp001350.jsp>.

Los Angeles City Department of Water and Power. *LADWP Stormwater Capture and Recycled Water Projects Approved By Board of Water and Power Commissioners*. February 2011. <http://www.ladwpnews.com/go/doc/1475/1001403/LADWP-Stormwater-Capture-and-Recycled-Water-Projects-Approved-By-Board-of-Water-Power-Commissioners>.

Los Angeles City Department of Water and Power. *A Water Recycling Plan for the Los Angeles Department of Water and Power*. April 1994.

Los Angeles City Department of Water and Power and Bureau of Sanitation. *City of Los Angeles Integrated Resources Plan, Facilities Plan*. Vols. 1-4. July 2004.

Los Angeles City Department of Water and Power. *City of Los Angeles Department of Water and Power Urban Water Management Plan Fiscal Year 2009-2010 Annual Update*. 2010.

Los Angeles City Department of Water and Power. *Groundwater Quality Management Plan San Fernando Valley Basin*. July 1, 1983.

Los Angeles City Department of Water and Power. *Emergency Water Conservation Plan Ordinance*. June 2008. <http://www.ladwpnews.com/go/doc/1475/204815/>

Los Angeles City Department of Water and Power. *Water Efficiency Requirements for New Development and Renovation of Existing Buildings*. July 2009.

Los Angeles City Department of Water and Power. *Los Angeles Aqueduct Simulation Model*. 2010.

Los Angeles City Department of Water and Power. *Urban Water Management Plan*. December 2005.

Los Angeles City Department of Water and Power. *Consumption and Earnings Report*. 1980-2010.

- Los Angeles City Department of Water and Power. *Electricity Billing Report*. 1980-2010.
- Los Angeles City Department of Water and Power. *Securing L.A.'s Water Supply*. May 2008.  
[http://mayor.lacity.org/stellent/groups/ElectedOfficials/@MYR\\_CH\\_Contributor/documents/ContributorWeb\\_Content/LACITY\\_004714.pdf](http://mayor.lacity.org/stellent/groups/ElectedOfficials/@MYR_CH_Contributor/documents/ContributorWeb_Content/LACITY_004714.pdf)
- Los Angeles City Planning Department. *City of Los Angeles Population and Housing Profile*. Los Angeles Department of City Planning / Demographic Research Unit. Retrieved 2010.  
<http://cityplanning.lacity.org/DRU/Loc/LocPfl.cfm?&geo=Cw&loc=LA>
- Los Angeles City Department of Building and Safety. *Graywater Systems for Residential Buildings, Document No. P/PC 2008-012*. January 26, 2010.
- Los Angeles County Department of Public Works. *Total Monthly Conserved Water During Water Year 2008-2009*. Retrieved 2010.  
<http://ladpw.org/wrd/SpreadingGround/watercon/file/Water%20Conserved%20Data%202008-2009.pdf>
- Los Angeles County. *Integrated Regional Water Management Plan*. December 2006.  
[http://www.ladpw.org/wmd/irwmp/docs/IRWMP\\_Consolidated.pdf](http://www.ladpw.org/wmd/irwmp/docs/IRWMP_Consolidated.pdf)
- Metropolitan Water District of Southern California. *Annual Water Quality Report 2002-2009*.
- Metropolitan Water District of Southern California. *The Metropolitan Water District of Southern California Annual Report 2010*. Retrieved 2010.  
<http://www.mwdh2o.com/mwdh2o/pages/about/AR/AR10.html>
- Metropolitan Water District of Southern California. *Final Groundwater Assessment Study*. September 2007.
- Metropolitan Water District of Southern California. *Regional Urban Water Management Plan*. November 2010.  
[http://www.mwdh2o.com/mwdh2o/pages/yourwater/RUWMP/RUWMP\\_2010.pdf](http://www.mwdh2o.com/mwdh2o/pages/yourwater/RUWMP/RUWMP_2010.pdf)
- Metropolitan Water District of Southern California. *Report on Sustainable Water Deliveries from the Colorado River Factoring in Climate Change*. Board Report. August 28, 2009.
- Metropolitan Water District of Southern California. *Integrated Water Resources Plan 2010 Update*. October 2010.  
<http://www.mwdh2o.com/mwdh2o/pages/yourwater/irp/IRP2010Report.pdf>
- Metropolitan Water District of Southern California. *Annual Progress Report to the California State Legislature, Achievements in Conservation, Recycling, and Groundwater Recharge*. February 2010.
- Metropolitan Water District of Southern California. *Annual Water Quality Report 2002-2009*.
- Million Trees LA. *Million Trees*. 2006.  
<http://www.milliontreesla.org/>
- Reynolds, Tom D., and Richards, Paul A. *Unit Operations and Processes in*

*Environmental Engineering, Second Edition.* 1996.

Southern California Association of Governments. *2008 Regional Transportation Plan Adopted Forecast.*  
May 2008.

Upper Los Angeles River Area Watermaster. *Watermaster Service in the Upper Los Angeles River Area,  
Los Angeles County, 2008-09 Water Year October 1, 2008 - September 30, 2009.*

Upper Los Angeles River Area Watermaster. *Ground Water Pumping and Spreading  
Plan, 2009-2014 Water Years.* July 2010.

US Department of Commerce, National Oceanic & Atmospheric Administration, National Climate Data Center.  
*Annual Climatological Survey, Station 5115/93134 Los Angeles 1948-2008 Downtown, USC.*

Wilkinson, Robert. *Methodology for Analysis of the Energy Intensity of California's Water Systems,* California  
Institute for Energy Efficiency, January 2000.



## **Groundwater Basin Adjudications**

- **San Fernando Basin – Judgment 650079**
- **Sylmar Basin – Judgment 650079**
- **Eagle Rock Basin – Judgment 650079**
- **West Coast Basin – Judgment 506806**
- **Central Basin – Judgment 786656**





1  
2  
3  
4  
5  
6  
7  
8  
9  
10  
11  
12  
13  
14  
15  
16  
17  
18  
19  
20  
21  
22  
23  
24  
25  
26  
27  
28

1. RECITALS

This matter was originally tried before the Honorable Edmund M. Moor, without jury, commencing on March 1, 1966, and concluding with entry of Findings, Conclusions and Judgment on March 14, 1968, after more than 181 trial days. Los Angeles appealed from said judgment and the California Supreme Court, by unanimous opinion, (14 Cal. 3d 199) reversed and remanded the case; after trial of some remaining issues on remand, and consistent with the opinion of the Supreme Court, and pursuant to stipulations, the Court signed and filed Findings of Fact and Conclusions of Law. Good cause thereby appearing,

IT IS ORDERED, ADJUDGED AND DECREED:

2. DEFINITIONS AND ATTACHMENTS

2.1 Definitions of Terms. As used in this Judgment, the following terms shall have the meanings herein set forth:

[1] Basin or Ground Water Basin -- A subsurface geologic formation with defined boundary conditions, containing a ground water reservoir, which is capable of yielding a significant quantity of ground water.

[2] Burbank -- Defendant City of Burbank.

[3] Crescenta Valley -- Defendant Crescenta Valley County Water district.

[4] Colorado Aqueduct -- The aqueduct facilities and system owned and operated by MWD for the importation of water from the Colorado River to its service area.

[5] Deep Rock -- Defendant Evelyn M. Pendleton, dba Deep Rock Artesian Water Company.

[6] Delivered Water -- Water utilized in a water supply distribution system, including reclaimed water.

[7] Eagle Rock Basin -- The separate ground water basin underlying the area shown as such on Attachment "A".

[8] Extract or Extraction -- To produce ground water, or its production, by pumping or any other means.

1  
2  
3  
4  
5  
6  
7  
8  
9  
10  
11  
12  
13  
14  
15  
16  
17  
18  
19  
20  
21  
22  
23  
24  
25  
26  
27  
28

[9] Fiscal Year -- July 1 through June 30 of the following calendar year.

[10] Foremost -- Defendant Foremost Foods Company, successor to defendant Sparkletts Drinking Water Corp.

[11] Forest Lawn -- Collectively, defendants Forest Lawn Cemetery Association, Forest Lawn Company, Forest Lawn Memorial-Park Association, and American Security and Fidelity Corporation.

[12] Gage F-57 -- The surface stream gaging station operated by Los Angeles County Flood Control District and situated in Los Angeles Narrows immediately upstream from the intersection of the Los Angeles River and Arroyo Seco, at which point the surface outflow from ULARA is measured.

[13] Glendale -- Defendant City of Glendale.

[14] Ground Water -- Water beneath the surface of the ground and within the zone of saturation.

[15] Hersch & Plumb -- Defendants David and Eleanor A. Hersch and Gerald B. and Lucille Plumb, successors to Wellesley and Duckworth defendants.

[16] Import Return Water -- Ground water derived from percolation attributable to delivered imported water.

[17] Imported Water -- Water used within ULARA, which is derived from sources outside said watershed. Said term does not include inter-basin transfers wholly within ULARA.

[18] In Lieu Storage -- The act of accumulating ground water in a basin by intentional reduction of extractions of ground water which a party has a right to extract.

[19] Lockheed -- Defendant Lockheed Aircraft Corporation.

[20] Los Angeles -- Plaintiff City of Los Angeles, acting by and through its Department of Water and Power.

[21] Los Angeles Narrows -- The physiographic area northerly of Gage F-57 bounded on the east by the San Rafael and Repetto Hills and on the west by the Elysian Hills, through which all natural outflow of the San Fernando Basin and the Los Angeles River flow en route to the Pacific Ocean.

1  
2  
3  
4  
5  
6  
7  
8  
9  
10  
11  
12  
13  
14  
15  
16  
17  
18  
19  
20  
21  
22  
23  
24  
25  
26  
27  
28

[22] MWD -- The Metropolitan Water District of Southern California, a public agency of the State of California.

[23] Native Safe Yield -- That portion of the safe yield of a basin derived from native waters.

[24] Native Waters -- Surface and ground waters derived from precipitation within ULARA.

[25] Overdraft -- A condition which exists when the total annual extractions of ground water from a basin exceed its safe yield, and when any temporary surplus has been removed.

[26] Owens-Mono Aqueduct -- The aqueduct facilities owned and operated by Los Angeles for importation to ULARA water from the Owens River and Mono Basin watersheds easterly of the Sierra-Nevada in Central California.

[27] Private Defendants -- Collectively, all of those defendants who are parties, other than Glendale, Burbank, San Fernando and Crescenta Valley.

[28] Reclaimed Water -- Water which, as a result of processing of waste water, is made suitable for and used for a controlled beneficial use.

[29] Regulatory Storage Capacity -- The volume of storage capacity of San Fernando Basin which is required to regulate the safe yield of the basin, without significant loss, during any long-term base period of water supply.

[30] Rising Water -- The effluent from a ground water basin which appears as surface flow.

[31] Rising Water Outflow -- The quantity of rising water which occurs within a ground water basin and does not rejoin the ground water body or is not captured prior to flowing past a point of discharge from the basin.

[32] Safe Yield -- The maximum quantity of water which can be extracted annually from a ground water basin under a given set of cultural conditions and extraction patterns, based on the long-term supply, without causing a continuing reduction of water in storage.

[33] San Fernando -- Defendant City of San Fernando.

1 [34] San Fernando Basin -- The separate ground water basin underlying the area  
2 shown as such on Attachment "A".

3 [35] Sportsman's Lodge -- Defendant Sportsman's Lodge Banquet Association.

4 [36] Stored Water -- Ground water in a basin consisting of either (1) imported or  
5 reclaimed water which is intentionally spread, or (2) safe yield water which is allowed to  
6 accumulate by In Lieu Storage. Said ground waters are distinguished and separately accounted  
7 for in a ground water basin, notwithstanding that the same may be physically commingled with  
8 other waters in the basin.

9 [37] Sylmar Basin -- The separate ground water basin underlying the area indicated as  
10 such on Attachment "A".

11 [38] Temporary Surplus -- The amount of ground water which would be required to be  
12 removed from a basin in order to avoid waste under safe yield operation.

13 [39] Toluca Lake -- Defendant Toluca Lake Property Owners Association.

14 [40] ULARA or Upper Los Angeles River Area -- The Upper Los Angeles River  
15 watershed, being the surface drainage area of the Los Angeles River tributary to Gage F-57.

16 [41] Underlying Pueblo Waters -- Native ground waters in the San Fernando Basin  
17 which underlie safe yield and stored waters.

18 [42] Valhalla -- Collectively, Valhalla Properties, Valhalla Memorial Park, Valhalla  
19 Mausoleum Park.

20 [43] Van de Kamp -- Defendant Van de Kamp's Holland Dutch Bakers, Inc.

21 [44] Verdugo Basin -- The separate ground water basin underlying the area shown as  
22 such on Attachment "A".

23 [45] Water Year -- October 1 through September 30 of the following calendar year.

24 Geographic Names, not herein specifically defined, are used to refer to the places and locations  
25 thereof as shown on Attachment "A".

26 2.2 List of Attachments. There are attached hereto the following documents, which are by  
27 this reference incorporated in this Judgment and specifically referred to in the text hereof:

28 "A" -- Map entitled "Upper Los Angeles River Area", showing Separate Basins therein.

1 “B” -- List of “Dismissed Parties”.

2 “C” -- List of “Defaulted Parties”.

3 “D” -- List of “Disclaiming Parties”.

4 “E” -- List of “Prior Stipulated Judgments.”

5 “F” -- List of “Stipulated Non-Consumptive or Minimal-Consumptive Use Practices.”

6 “G” -- Map entitled “Place of Use and Service Area of Private Defendants.”

7 “H” -- Map entitled “Public Agency Water Service Areas.”

8 *[Attachments B-H are available upon request from LADWP – UWMP Note 2005]*

9 3. PARTIES

10 3.1 Defaulting and Disclaiming Defendants. Each of the defendants listed on Attachment  
11 “C” and Attachment “D” is without any right, title or interest in, or to any claim to extract ground water  
12 from ULARA or any of the separate ground water basins therein.

13 3.2 No Rights Other Than as Herein Declared. No party to this action has any rights in or to  
14 the waters of ULARA except to the extent declared herein.

15 4. DECLARATION RE GEOLOGY AND HYDROLOGY

16 4.1 Geology.

17 4.1.1 ULARA. ULARA (or Upper Los Angeles River Area), is the watershed or surface  
18 drainage area tributary to the Los Angeles River at Gage F-57. Said watershed contains a total of  
19 329,000 acres, consisting of approximately 123,000 acres of valley fill area and 206,000 acres of  
20 hill and mountain area, located primarily in the County of Los Angeles, with a small portion in  
21 the County of Ventura. Its boundaries are shown on Attachment “A”. The San Gabriel  
22 Mountains form the northerly portion of the watershed, and from them two major washes--the  
23 Pacoima and the Tujunga--discharge southerly. Tujunga Wash traverses the valley fill in a  
24 southerly direction and joins the Los Angeles River, which follows an easterly course along the  
25 base of the Santa Monica Mountains before it turns south through the Los Narrows. The waters  
26 of Pacoima Wash as and when they flow out of Sylmar Basin are tributary to San Fernando  
27 Basin. Lesser tributary washes run from the Simi Hills and the Santa Susana Mountains in the  
28



1 westerly portion of the watershed. Other minor washes, including Verdugo Wash, drain the  
2 easterly portion of the watershed which consists of the Verdugo Mountains, the Elysian, San  
3 Rafael and Repetto Hills. Each of said washes is a non-perennial stream whose flood flows and  
4 rising waters are naturally tributary to the Los Angeles River. The Los Angeles River within  
5 ULARA and most of said tributary natural washes have been replaced, and in some instances  
6 relocated, by concrete-lined flood control channels. There are 85.3 miles of such channels  
7 within ULARA, 62% of which have lined concrete bottoms.

8 4.1.2 San Fernando Basin. San Fernando Basin is the major ground water basin in  
9 ULARA. It underlies 112,047 acres and is located in the area shown as such on Attachment “A”.  
10 Boundary conditions of the San Fernando Basin consist on the east and northeast of alluvial  
11 contacts with non-waterbearing series along the San Rafael Hills and Verdugo Mountains and  
12 the Santa Susana Mountains and Simi Hills on the northwest and west and the Santa Monica  
13 Mountains on the south. Water-bearing material in said basin extends to at least 1000 feet below  
14 the surface. Rising water outflow from the San Fernando Basin passes its downstream and  
15 southerly boundary in the vicinity of Gage F-57, which is located in Los Angeles Narrows about  
16 300 feet upstream from the Figueroa Street (Dayton Street) Bridge. The San Fernando Basin is  
17 separated from the Sylmar Basin on the north by the eroded south limb of the Little Tujunga  
18 Syncline which causes a break in the ground water surface of about 40 to 50 feet.

19 4.1.3 Sylmar Basin. Sylmar Basin underlies 5,565 acres and is located in the area shown  
20 as such on Attachment “A”. Water-bearing material in said basin extends to depths in excess of  
21 12,000 feet below the surface. Boundary conditions of Sylmar Basin consist of the San Gabriel  
22 Mountains on the north, a topographic divide in the valley fill between the Mission Hills and San  
23 Gabriel Mountains on the west, the Mission Hills on the southwest, Upper Lopez Canyon Saugus  
24 Formation on the east, along the east bank of Pacoima Wash, and the eroded south limb of the  
25 Little Tujunga Syncline on the south.

26 4.1.4 Verdugo Basin. Verdugo Basin underlies 4,400 acres and is located in the area  
27 shown as such on Attachment “A”. Boundary conditions of Verdugo Basin consist of the San  
28 Gabriel Mountains on the north, the Verdugo Mountains on the south and southwest, the San

1 Rafael Hills on the southeast and the topographic divide on the east between the drainage area  
2 that is tributary to the Tujunga Wash to the west and Verdugo Wash to the east, the ground water  
3 divide on the west between Monk Hill-Raymond Basin and the Verdugo Basin on the east and a  
4 submerged dam constructed at the mouth of Verdugo Canyon on the south.

5 4.1.5 Eagle Rock Basin. Eagle Rock Basin underlies 807 acres and is located in the area  
6 shown as such on Attachment “A”. Boundary conditions of Eagle Rock Basin consist of the San  
7 Rafael Hills on the north and west and the Repetto Hills on the east and south with a small  
8 alluvial area to the southwest consisting of a topographic divide.

9 4.2 Hydrology.

10 4.2.1 Water Supply. The water supply of ULARA consists of native waters, derived  
11 from precipitation on the valley floor and runoff from the hill and mountain areas, and of  
12 imported water from outside the watershed. The major source of imported water has been from  
13 the Owens-Mono Aqueduct, but additional supplies have been and are now being imported  
14 through MWD from its Colorado Aqueduct and the State Aqueduct.

15 4.2.2 Ground Water Movement. The major water-bearing formation in ULARA is the  
16 valley fill material bounded by hills and mountains which surround it. Topographically, the  
17 valley-fill area has a generally uniform grade in a southerly and easterly direction with the slope  
18 gradually decreasing from the base of the hills and mountains to the surface drainage outlet at  
19 Gage F-57. The valley fill material is a heterogeneous mixture of clays, silts, sand and gravel  
20 laid down as alluvium. The valley fill is of greatest permeability along and easterly of Pacoima  
21 and Tujunga Washes and generally throughout the eastern portion of the valley fill area, except  
22 in the vicinity of Glendale where it is of lesser permeability. Ground water occurs mainly within  
23 the valley fill, with only negligible amounts occurring in hill and mountain areas. There is no  
24 significant ground water movement from the hill and mountain formations into the valley fill.  
25 Available geologic data do not indicate that there are any sources of native ground water other  
26 than those derived from precipitation. Ground water movement in the valley fill generally  
27 follows the surface topography and drainage except where geologic or man-made impediments  
28 occur or where the natural flow has been modified by extensive pumping.

1                   4.2.3 Separate Ground Water Basins. The physical and geologic characteristics of each  
 2 of the ground water basins, Eagle rock, Sylmar, Verdugo and San Fernando, cause impediments  
 3 to inter-basin ground water flow whereby there is created separate underground reservoirs. Each  
 4 of said basins contains a common source of water supply to parties extracting ground water from  
 5 each of said basins. The amount of underflow from Sylmar Basin, Verdugo Basin and Eagle  
 6 Rock Basin to San Fernando Basin is relatively small, and on the average has been  
 7 approximately 540 acre feet per year from the Sylmar Basin; 80 acre feet per year from Verdugo  
 8 Basin; and 50 acre feet per year from Eagle Rock Basin. Each has physiographic, geologic and  
 9 hydrologic differences, one from the other, and each meets the hydrologic definition of “basin”.  
 10 The extractions of water in the respective basins affect the other water users within that basin but  
 11 do not significantly or materially affect the ground water levels in any of the other basins. The  
 12 underground reservoirs of Eagle Rock, Verdugo and Sylmar Basins are independent of one  
 13 another and of the San Fernando Basin.

14                   4.2.4 Safe Yield and Native Safe Yield. The safe yield and native safe yield, stated in  
 15 acre feet, of the three largest basins for the year 1964-65 was as follows:

<u>Basin</u>	<u>Safe Yield</u>	<u>Native Safe Yield</u>
San Fernando	90,680	43,660
Sylmar	6,210	3,850
Verdugo	7,150	3,590

20 The safe yield of Eagle Rock Basin is derived from imported water delivered by Los Angeles.  
 21 There is no measurable native safe yield.

22                   4.2.5 Separate Basins -- Separate Rights. The rights of the parties to extract ground  
 23 water within ULARA are separate and distinct as within each of the several ground water basins  
 24 within said watershed.

25                   4.2.6 Hydrologic Condition of Basins. The several basins within ULARA are in varying  
 26 hydrologic conditions, which result in different legal consequences.

27                   4.2.6.1 San Fernando Basin. The first full year of overdraft in San Fernando  
 28 Basin was 1954-55. It remained in overdraft continuously until 1968, when an injunction

1 herein became effective. Thereafter, the basin was placed on safe yield operation. There  
2 is no surplus ground water available for appropriation or overlying use from San  
3 Fernando Basin.

4 4.2.6.2 Sylmar Basin. Sylmar Basin is not in overdraft. There remains safe  
5 yield over and above the present reasonable beneficial overlying uses, from which safe  
6 yield the appropriative rights of Los Angeles and San Fernando may be and have been  
7 exercised.

8 4.2.6.3 Verdugo Basin. Verdugo Basin was in overdraft for more than five  
9 consecutive years prior to 1968. Said basin is not currently in overdraft, due to decreased  
10 extractions by Glendale and Crescenta Valley on account of poor water quality.  
11 However, the combined appropriative and prescriptive rights of Glendale and Crescenta  
12 Valley are equivalent to the safe yield of the Basin. No private overlying or appropriative  
13 rights exist in Verdugo Basin.

14 4.2.6.4 Eagle Rock Basin. The only measure water supply to Eagle Rock  
15 Basin is import return water by reason of importations by Los Angeles. Extractions by  
16 Foremost and Deep Rock under the prior stipulated judgments have utilized the safe yield  
17 of Eagle Rock Basin, and have maintained hydrologic equilibrium therein.

## 19 5. DECLARATION OF RIGHTS

### 20 5.1 Right to Native Waters.

#### 21 5.1.1 Los Angeles River and San Fernando Basin.

22 5.1.1.1 Los Angeles' Pueblo Right. Los Angeles, as the successor to all  
23 rights, claims and powers of the Spanish Pueblo de Los Angeles in regard to water rights,  
24 is the owner of a prior and paramount pueblo right to the surface waters of the Los  
25 Angeles River and the native ground waters of San Fernando Basin to meet its reasonable  
26 beneficial needs and for its inhabitants.

27 5.1.1.2 Extent of Pueblo Right. Pursuant to said pueblo right, Los Angeles is  
28 entitled to satisfy its needs and those of its inhabitants within its boundaries as from time

1 to time modified. Water which is in fact used for pueblo right purposes is and shall be  
2 deemed needed for such purposes.

3 5.1.1.3 Pueblo Right -- Nature and Priority of Exercise. The pueblo right of  
4 Los Angeles is a prior and paramount right to all of the surface waters of the Los Angeles  
5 River, and native ground water in San Fernando Basin, to the extent of the reasonable  
6 needs and uses of Los Angeles and its inhabitants throughout the corporate area of Los  
7 Angeles, as its boundaries may exist from time to time. To the extent that the Basin  
8 contains native waters and imported waters, it is presumed that the first water extracted  
9 by Los Angeles in any water year is pursuant to its pueblo right, up to the amount of the  
10 native safe yield. The next extractions by Los Angeles in any year are deemed to be from  
11 import return water, followed by stored water, to the full extent of Los Angeles' right to  
12 such import return water and stored water. In the event of need to meet water  
13 requirements of its inhabitants, Los Angeles has the additional right, pursuant to its  
14 pueblo right, withdraw temporarily from storage Underlying Pueblo Waters, subject to an  
15 obligation to replace such water as soon as practical.

16 5.1.1.4 Rights of Other Parties. No other party to this action has any right in  
17 or to the surface waters of the Los Angeles River or the native safe yield of the San  
18 Fernando Basin.

19 5.1.2 Sylmar Basin Rights.

20 5.1.2.1 No Pueblo Rights. The pueblo right of Los Angeles does not extend  
21 to or include ground waters in Sylmar Basin.

22 5.1.2.2 Overlying Rights. Defendants Moordigian and Hersch & Plumb own  
23 lands overlying Sylmar Basin and have a prior correlative right to extract native waters  
24 from said Basin for reasonable beneficial uses on their said overlying lands. Said right is  
25 appurtenant to said overlying lands and water extracted pursuant thereto may not be  
26 exported from said lands nor can said right be transferred or assigned separate and apart  
27 from said overlying lands.  
28

1  
2  
3  
4  
5  
6  
7  
8  
9  
10  
11  
12  
13  
14  
15  
16  
17  
18  
19  
20  
21  
22  
23  
24  
25  
26  
27  
28

5.1.2.3 Appropriative Rights of San Fernando and Los Angeles. San Fernando and Los Angeles own appropriative rights, of equal priority, to extract and put to reasonable beneficial use for the needs of said cities and their inhabitants, native waters of the Sylmar Basin in excess of the exercised reasonable beneficial needs of overlying users. Said appropriative rights are:

San Fernando	3,580 acre feet
Los Angeles	1,560 acre feet.

5.1.2.4 No Prescription. The Sylmar Basin is not presently in a state of overdraft and no rights by prescription exist in said Basin against any overlying or appropriative water user.

5.1.2.5 Other Parties. No other party to this action owns or possesses any right to extract native ground waters from the Sylmar Basin.

5.1.3 Verdugo Basin Rights.

5.1.3.1 No Pueblo Rights. The pueblo right of Los Angeles does not extend to or include ground water in Verdugo Basin.

5.1.3.2 Prescriptive Rights of Glendale and Crescenta Valley. Glendale and Crescenta Valley own prescriptive rights as against each other and against all private overlying or appropriative parties in the Verdugo Basin to extract, with equal priority, the following quantities of water from the combined safe yield of native and imported waters in Verdugo Basin:

Glendale	3,856 acre feet
Crescenta Valley	3,294 acre feet.

5.1.3.3 Other Parties. No other party to this action owns or possesses any right to extract native ground waters from the Verdugo Basin.

5.1.4 Eagle Rock Basin Rights.

5.1.4.1 No Pueblo Rights. The pueblo right of Los Angeles does not extend to or include ground water in Eagle Rock Basin.

1                                   5.1.4.2 No Rights in Native Waters. The Eagle Rock Basin has no significant  
2 or measurable native safe yield and no parties have or assert any right or claim to native  
3 waters in said Basin.

4                   5.2 Rights to Imported Waters.

5                   5.2.1 San Fernando Basin Rights.

6                                   5.2.1.1 Rights to Recapture Import Return Water. Los Angeles, Glendale,  
7 Burbank and San Fernando have each caused imported waters to be brought into ULARA  
8 and to be delivered to lands overlying the San Fernando Basin, with the result that  
9 percolation and return flow of such delivered water has caused imported waters to  
10 become a part of the safe yield of San Fernando Basin. Each of said parties has a right to  
11 extract from San Fernando Basin that portion of the safe yield of the Basin attributable to  
12 such import return waters.

13                                   5.2.1.2 Rights to Store and Recapture Stored Water. Los Angeles has  
14 heretofore spread imported water directly in San Fernando Basin. Los Angeles,  
15 Glendale, Burbank and San Fernando each have rights to store water in San Fernando  
16 Basin by direct spreading or in lieu practices. To the extent of any future spreading or in  
17 lieu storage of import water or reclaimed water by Los Angeles, Glendale, Burbank or  
18 San Fernando, the party causing said water to be so stored shall have a right to extract an  
19 equivalent amount of ground water from San Fernando Basin. The right to extract waters  
20 attributable to such storage practices is an undivided right to a quantity of water in San  
21 Fernando Basin equal to the amount of such Stored Water to the credit of any party, as  
22 reflected in Watermaster records.

23                                   5.2.1.3 Calculation of Import Return Water and Stored Water Credits. The  
24 extraction rights of Los Angeles, Glendale, Burbank and San Fernando in San Fernando  
25 Basin in any year, insofar as such rights are based upon import return water, shall only  
26 extend to the amount of any accumulated import return water credit of such party by  
27 reason of imported water delivered after September 30, 1977. The annual credit for such  
28

1  
2  
3  
4  
5  
6  
7  
8  
9  
10  
11  
12  
13  
14  
15  
16  
17  
18  
19  
20  
21  
22  
23  
24  
25  
26  
27  
28

import return water shall be calculated by Watermaster based upon the amount of delivered water during the preceding water year, as follows:

Los Angeles:	20.8% of all delivered water (including reclaimed water) to valley fill lands of San Fernando Basin.
San Fernando:	26.3% of all imported and reclaimed water delivered to valley-fill lands of San Fernando Basin.
Burbank:	20.0% of all delivered water (including reclaimed water) to San Fernando Basin and its tributary hill and mountain areas.
Glendale:	20.0% of all delivered water (including reclaimed water) to San Fernando Basin and its tributary hill and mountain areas (i.e., total delivered water, [including reclaimed water], less 105% of total sales by Glendale in Verdugo Basin and its tributary hills).

In calculating Stored Water credit, by reason of direct spreading of imported or reclaimed water, Watermaster shall assume that 100% of such spread water reached the ground water in the year spread.

5.2.1.4 Cumulative Import Return Water Credits. Any import return water which is not extracted in a given water year shall be carried over, separately accounted for, and maintained as a cumulative credit for purposes of future extractions.

5.2.1.5 Overextractions. In addition to extractions of stored water, Glendale, Burbank or San Fernando may, in any water year, extract from San Fernando Basin an amount not exceeding 10% of such party's last annual credit for import return water, subject, however, to an obligation to replace such overextraction by reduced extractions during the next succeeding water year. Any such overextraction which is not so replaced shall constitute physical solution water, which shall be deemed to have been extracted in said subsequent water year.



1                                   5.2.1.6 Private Defendant. No private defendant is entitled to extract water  
2 from the San Fernando Basin on account of the importation of water thereto by overlying  
3 public entities.

4                                   5.2.2 Sylmar Basin Rights.

5                                   5.2.2.1 Rights to Recapture Import Return Waters. Los Angeles and San  
6 Fernando have caused imported waters to be brought into ULARA and delivered to lands  
7 overlying the Sylmar Basin with the result that percolation and return flow of such  
8 delivered water has caused imported waters to become a part of the safe yield of Sylmar  
9 Basin. Los Angeles and San Fernando are entitled to recover from Sylmar Basin such  
10 imported return waters. In calculating the annual entitlement to recapture such import  
11 return water, Los Angeles and San Fernando shall be entitled to 35.7% of the preceding  
12 water year's imported water delivered by such party to lands overlying Sylmar Basin.  
13 Thus, by way of example, in 1976-77, Los Angeles was entitled to extract 2370 acre feet  
14 of ground water from Sylmar Basin, based on delivery to lands overlying said Basin of  
15 6640 acre feet during 1975-76. The quantity of San Fernando's imported water to, and  
16 the return flow therefrom, in the Sylmar Basin in the past has been of such minimal  
17 quantities that it has not been calculated.

18                                   5.2.2.2 Rights to Store and Recapture Stored Water. Los Angeles and San  
19 Fernando each have the right to store water in Sylmar Basin equivalent to their rights in  
20 San Fernando Basin under paragraph 5.2.1.2 hereof.

21                                   5.2.2.3 Carry Over. Said right to recapture stored water, import return water  
22 and other safe yield waters to which a party is entitled, if not exercised in a given year,  
23 can be carried over for not to exceed five years, if the underflow through Sylmar Notch  
24 does not exceed 400 acre feet per year.

25                                   5.2.2.4 Private Defendants. No private defendant is entitled to extract water  
26 from within the Sylmar Basin on account of the importation of water thereto by overlying  
27 public entities.

28                                   5.2.3 Verdugo Basin Rights.



1 and paramount pueblo right of Los Angeles in and to such waters, except pursuant to the physical  
2 solution herein decreed.

3           6.2     Each and Every Private Defendant -- from extracting ground water from the SAN  
4 FERNANDO, VERDUGO, or EAGLE ROCK BASINS, except pursuant to physical solution provisions  
5 hereof.

6           6.3     Defaulting and Disclaiming Parties (listed in Attachments “C” and “D”) -- from diverting  
7 or extracting water within ULARA, except pursuant to the physical solution herein decreed.

8           6.4     Glendale -- from extracting ground water from SAN FERNANDO BASIN in any water  
9 year in quantities exceeding its import return water credit and any stored water credit, except pursuant to  
10 the physical solution; and from extracting water from VERDUGO BASIN in excess of its appropriate  
11 and prescriptive right declared herein.

12           6.5     Burbank -- from extracting ground water from SAN FERNANDO BASIN in any water  
13 year in quantities exceeding its import return water credit and any stored water credit, except pursuant to  
14 the physical solution decreed herein.

15           6.6     San Fernando -- from extracting ground water from SAN FERNANDO BASIN in any  
16 water year in quantities exceeding its import return water credit and any stored water credit, except  
17 pursuant to the physical solution herein decreed.

18           6.7     Crescenta Valley -- from extracting ground water from VERDUGO BASIN in any year  
19 in excess of its appropriate and prescriptive right declared herein.

20           6.8     Los Angeles -- from extracting ground water from SAN FERNANDO BASIN in any  
21 year in excess of the native safe yield, plus any import return water credit and stored water credit of said  
22 city; provided, that where the needs of Los Angeles require the extraction of Underlying Pueblo Waters,  
23 Los Angeles may extract such water subject to an obligation to replace such excess as soon as practical;  
24 and from extracting ground water from VERDUGO BASIN in excess of any credit for import return  
25 water which Los Angeles may acquire by reason of delivery of imported water for use overlying said  
26 basin, as hereinafter confirmed on application to Watermaster and by subsequent order of the Court.

27  
28



1  
2  
3  
4  
5  
6  
7  
8  
9  
10  
11  
12  
13  
14  
15  
16  
17  
18  
19  
20  
21  
22  
23  
24  
25  
26  
27  
28

8.2.2 Requirement for Reports, Information and Records. Watermaster may require any party to furnish such reports, information and records as may be reasonably necessary to determine compliance or lack of compliance by any party with the provisions of this Judgment.

8.2.3 Requirement of Measuring Devices. Watermaster shall require all parties owning or operating any facilities for extraction of ground water from ULARA to install and maintain at all times in good working order, at such party’s own expense, appropriate meters or other measuring devices satisfactory to the Watermaster.

8.2.4 Inspection by Watermaster. Watermaster shall make inspections of (a) ground water extraction facilities and measuring devices of any party, and (b) water use practices by any party under physical solution conditions, at such times and as often as may be reasonable under the circumstances to verify reported data and practices of such party. Watermaster shall also identify and report on any new or proposed new ground water extractions by any party or non-party.

8.2.5 Policies and Procedures. Watermaster shall, with the advice and consent of the Administrative Committee, adopt and amend from time to time Policies and Procedures as may be reasonably necessary to guide Watermaster in performance of its duties, powers and responsibilities under the provisions of this judgment.

8.2.6 Data Collection. Watermaster shall collect and verify data relative to conditions of ULARA and its ground water basins from the parties and one or more other governmental agencies. Where necessary, and upon approval of the Administrative Committee, Watermaster may develop supplemental data.

8.2.7 Cooperation With Other Agencies. Watermaster may act jointly or cooperate with agencies of the United States and the State of California or any political subdivisions, municipalities or districts (including any party) to secure or exchange data to the end that the purpose of this Judgment, including its physical solution, may be fully and economically carried out.

1           8.2.8 Accounting for Non-consumptive Use. Watermaster shall calculate and report  
2 annually the non-consumptive and consumptive uses of extracted ground water by each party  
3 listed in Attachment “F”.

4           8.2.9 Accounting for Accumulated Import Return Water and Stored Water. Watermaster  
5 shall record and verify additions, extractions and losses and maintain an annual and cumulative  
6 account of all (a) stored water and (b) import return water in San Fernando Basin. Calculation of  
7 losses attributable to Stored Water shall be approved by the Administrative Committee or by  
8 subsequent order of the Court. For purposes of such accounting, extractions in any water year by  
9 Glendale, Burbank or San Fernando shall be assumed to be first from accumulated import return  
10 water, second from stored water, and finally pursuant to physical solution; provided, that any  
11 such city may, by written notice of intent to Watermaster, alter said priority of extractions as  
12 between import return water and stored water.

13           8.2.10 Recalculation of Safe Yield. Upon request of the Administrative Committee, or  
14 on motion of any party and subsequent Court order, Watermaster shall recalculate safe yield of  
15 any basin within ULARA. If there has been a material long-term change in storage over a base  
16 period (excluding any effects of stored water) in San Fernando Basin the safe yield shall be  
17 adjusted by making a corresponding change in native safe yield of the Basin.

18           8.2.11 Watermaster Report. Watermaster shall prepare annually and (after review and  
19 approval by Administrative Committee) cause to be served on all active parties, on or before  
20 May 1, a report of hydrologic conditions and Watermaster activities within ULARA during the  
21 preceding water year. Watermaster’s annual report shall contain such information as may be  
22 requested by the Administrative Committee, required by Watermaster Policies and Procedures or  
23 specified by subsequent order of this Court.

24           8.2.12 Active Party List. Watermaster shall maintain at all times a current list of active  
25 parties and their addresses.

26           8.3 Administrative Committee.

27           8.3.1 Committee to be Formed. An Administrative Committee shall be formed to advise  
28 with, request or consent to, and review actions of Watermaster. Said Administrative Committee

1 shall be composed of one representative of each party having a right to extract ground water  
2 from ULARA, apart from the physical solution. Any such party not desiring to participate in  
3 such committee shall so advise Watermaster in writing.

4 8.3.2 Organization and Voting. The Administrative Committee shall organize and adopt  
5 appropriate rules and regulations to be included in Watermaster Policies and Procedures. Action  
6 of the Administrative Committee shall be by unanimous vote of its members, or of the members  
7 affected in the case of an action which affects one or more basins but less than all of ULARA. In  
8 the event of inability of the Committee to reach a unanimous position, the matter may, at the  
9 request of Watermaster or any party, be referred to the Court for resolution by subsequent order  
10 after notice and hearing.

11 8.3.3 Function and Powers. The Administrative Committee shall be consulted by  
12 Watermaster and shall request or approve all discretionary Watermaster determinations. In the  
13 event of disagreement between Watermaster and the Administrative Committee, the matter shall  
14 be submitted to the Court for review and resolution.

15 8.4 Watermaster Budget and Assessments.

16 8.4.1 Watermaster's Proposed Budget. Watermaster shall, on or before May 1, prepare  
17 and submit to the Administrative Committee a budget for the ensuing water year. The budget  
18 shall be determined for each basin separately and allocated between the separate ground water  
19 basins. The total for each basin shall be allocated between the public agencies in proportion to  
20 their use of ground water from such basin during the preceding water year.

21 8.4.2 Objections and Review. Any party who objects to the proposed budget, or to such  
22 party's allocable share thereof, may apply to the Court within thirty (30) days of receipt of the  
23 proposed budget from Watermaster for review and modification. Any such objection shall be  
24 duly noticed to all interested parties and heard within thirty (30) days of notice.

25 8.4.3 Notice of Assessment. After thirty (30) days from delivery of Watermaster's  
26 proposed budget, or after the order of Court settling any objections thereto, Watermaster shall  
27 serve notice on all parties to be assessed of the amount of assessment and the required payment  
28 schedule.







1 The nature of each said defendant’s water use practices is described in Attachment “F”. Subject  
 2 to required reports to and inspections by Watermaster, each said defendant may continue  
 3 extractions for said purposes so long as in any year such party continues such non-consumptive  
 4 or minimal-consumptive use practices.

5 9.2.3 Abandoned Operations. The following stipulating defendants have ceased  
 6 extracting water from San Fernando Basin and no further need exists for physical solution in  
 7 their behalf:

- 8 Knickerbocker Plastic Company, Inc.
- 9 Carnation Company
- 10 Hidden Hills Mutual Water Company
- 11 Southern Pacific Railroad Co.
- 12 Pacific Fruit Express Co.

13 9.3 Private Defendants. There are private defendants who installed during the years of  
 14 temporary surplus relatively substantial facilities to extract and utilize ground waters of San Fernando  
 15 Basin. Said defendants may continue their extractions for consumptive use up to the indicated annual  
 16 quantities upon payment of compensation to the appropriate city wherein their use of water is principally  
 17 located, on the basis of the following physical solution:

18 9.3.1 Private Defendants and Appropriate Cities. Said private defendants and the cities  
 19 to which their said extractions shall be charged and to which physical solution payment shall be  
 20 made are:

		<u>Annual Quantities</u> <u>(acre feet)</u>
23	Los Angeles	- Toluca Lake 100
24		Sportsman’s Lodge 25
		Van de Kamp 120
25	Glendale	- Forest Lawn 400
26		Southern Service Co. 75
27	Burbank	- Valhalla 300
28		Lockheed 25

1 Provided that said private defendants shall not develop, install or operate new wells or other  
2 facilities which will increase existing extraction capacities.

3 9.3.2 Reports and Accounting. All extractions pursuant to this physical solution shall be  
4 subject to such reasonable reports and inspection as may be required by Watermaster.

5 9.3.3 Payment. Water extracted pursuant hereto shall be compensated for by annual  
6 payment to Los Angeles, and as agreed upon pursuant to paragraph 9.3.3.2 to Glendale and  
7 Burbank, thirty days from day of notice by Watermaster, on the following basis:

8 9.3.3.1 Los Angeles. An amount equal to what such party would have paid  
9 had water been delivered from the distribution system of Los Angeles, less the average  
10 energy cost of extraction of ground water by Los Angeles from San Fernando.

11 9.3.3.2 Glendale or Burbank. An amount equal to the sum of the amount  
12 payable to Los Angeles under paragraph 9.4 hereof and any additional charges or  
13 conditions agreed upon by either such city and any private defendant.

14 9.4 Glendale and Burbank. Glendale and Burbank have each installed, during said years of  
15 temporary surplus, substantial facilities to extract and utilize waters of the San Fernando Basin. In  
16 addition to the use of such facilities to recover import return water, the distribution facilities of such  
17 cities can be most efficiently utilized by relying upon the San Fernando Basin for peaking supplies in  
18 order to reduce the need for extensive new surface storage. Glendale and Burbank may extract annual  
19 quantities of ground water from the San Fernando Basin, in addition to their rights to import return water  
20 or stored water, as heretofore declared, in quantities up to:

21 Glendale 5,500 acre feet

22 Burbank 4,200 acre feet;

23 provided, that said cities shall compensate Los Angeles annually for any such excess extractions over  
24 and above their declared rights at a rate per acre foot equal to the average MWD price for municipal and  
25 industrial water delivered to Los Angeles during the fiscal year, less the average energy cost of  
26 extraction of ground water by Los Angeles from San Fernando Basin during the preceding fiscal year.

27 Provided, further, that ground water extracted by Forest Lawn and Southern Service Co. shall be  
28 included in the amount taken by Glendale, and the amount extracted by Valhalla and Lockheed shall be

1 included in the amount taken by Burbank. All water taken by Glendale or Burbank pursuant hereto shall  
2 be charged against Los Angeles' rights in the year of such extractions.

3 In the event of emergency, and upon stipulation or motion and subsequent order of the  
4 Court, said quantities may be enlarged in any year.

5 9.5 San Fernando. San Fernando delivers imported water on lands overlying the San  
6 Fernando Basin, by reason of which said city has a right to recover import return water. San Fernando  
7 does not have water extraction facilities in the San Fernando Basin, nor would it be economically or  
8 hydrologically useful for such facilities to be installed. Both San Fernando and Los Angeles have  
9 decreed appropriative rights and extraction facilities in the Sylmar Basin. San Fernando may extract  
10 ground water from the Sylmar Basin in a quantity sufficient to utilize its San Fernando Basin import  
11 return water credit, and Los Angeles shall reduce its Sylmar Basin extractions by an equivalent amount  
12 and receive an offsetting entitlement for additional San Fernando Basin extractions.

13 9.6 Effective Date. This physical solution shall be effective on October 1, 1978, based upon  
14 extractions during water year 1978-79.

## 15 10. MISCELLANEOUS PROVISIONS

16 10.1 Designation of Address for Notice and Service. Each party shall designate the name and  
17 address to be used for purposes of all subsequent notices and service herein by a separate designation to  
18 be filed with Watermaster within thirty (30) days after Notice of Entry of Judgment has been served.  
19 Said designation may be changed from time to time by filing a written notice of such change with the  
20 Watermaster. Any party desiring to be relieved of receiving notices of Watermaster activity may file a  
21 waiver of notice on a form to be provided by Watermaster. Thereafter such party shall be removed from  
22 the Active Party list. For purposes of service on any party or active party by the Watermaster, by any  
23 other party, or by the Court, of any item required to be served upon or delivered to such party or active  
24 party under or pursuant to the Judgment, such service shall be made personally or by deposit in the  
25 United States mail, first class, postage prepaid, addressed to the designee and at the address in the latest  
26 designation filed by such party or active party.  
27  
28



1 HELM, BUDINGER & LEMIEUX  
2 An Association, Including A  
3 Professional Corporation  
4 4444 Riverside Drive, Suite 201  
5 Burbank, CA. 91505  
6 (213) 849-6473

7  
8 Attorneys for Defendant,  
9 Dominguez Water Corporation

10 SUPERIOR COURT OF THE STATE OF CALIFORNIA  
11 FOR THE COUNTY OF LOS ANGELES

12 CALIFORNIA WATER SERVICE ) No. 506,806  
13 COMPANY, et al., ) AMENDED  
14 ) JUDGMENT  
15 Plaintiff,) )  
16 vs. ) (DECLARING AND ESTABLISHING  
17 ) WATER RIGHTS IN THE WEST COAST  
18 ) BASIN, IMPOSING A PHYSICAL  
19 ) SOLUTION THEREIN AND ENJOINING  
20 ) EXTRACTIONS THEREFROM IN  
21 ) EXCESS OF SPECIFIED  
22 ) QUANTITIES.)  
23 )  
24 )  
25 )  
26 )  
27 )  
28 )

1 INTRODUCTION

2 The above - entitled matter came on regularly for further trial  
3 before the Honorable George Francis, Judge of the Superior Court  
4 of the State of California, assigned by the Chairman of the  
5 Judicial Council to sit in this case on Friday the 21st day of  
6 July, 1961. Thereupon plaintiffs filed a dismissal of the action  
7 as to certain defendants named in the Complaint and in the  
8 Amended Complaint herein who are not mentioned or referred to in  
9 Paragraph III of this Judgment, and the further trial of the  
10 action proceeded in respect to the remaining parties.

11 The objections to the Report of Referee and to all supplemental  
12 Reports thereto, having been considered upon exceptions thereto  
13 filed with the Clerk of the Court in the manner of and within  
14 the time allowed by law, were overruled.

15 Oral and documentary evidence was introduced, and the matter was  
16 submitted to the Court for decision. Findings of Fact,  
17 Conclusions of Law and Judgment herein have heretofore been  
18 signed and filed.

19 Pursuant to the reserved and continuing jurisdiction of the  
20 Court under the Judgment herein, certain amendments to said  
21 Judgment and temporary Orders have heretofore been made and  
22 entered.

23 Continuing jurisdiction of the Court under said Judgment is  
24 currently assigned to the HONORABLE JULIUS M. TITLE.

25 The motion of defendant herein, DOMINGUEZ WATER CORPORATION, for  
26 further amendments to the Judgment, notice thereof and of the

27  
28

1 hearing thereon having been duly and regularly given to all  
2 parties, came on for hearing in Department 48 of the above-  
3 entitled Court on March 21, 1980, at 1:30 o'clock P.M., before  
4 said HONORABLE JULIUS M. TITLE. Defendant, DOMINGUEZ WATER  
5 CORPORATION, was represented by its attorneys, Helm, Budinger &  
6 Lemieux, and Ralph B. Helm. Various other parties were  
7 represented by counsel of record appearing on the Clerk's  
8 records. Hearing thereon was concluded on that date. The within  
9 "Amended Judgment" incorporates amendments and orders heretofore  
10 made to the extent presently operable and amendments pursuant to  
11 said last mentioned motion. To the extent this Amended Judgment  
12 is a restatement of the Judgment as heretofore amended, it is  
13 for convenience in incorporating all matters in one document, it  
14 is not a readjudication of such matters and is not intended to  
15 reopen any such matters. As used hereinafter the word "Judgment"  
16 shall include the original Judgment as amended to date.

17 NOW, THEREFORE, IT IS HEREBY ORDERED, ADJUDGED AND DECREED AS  
18 FOLLOWS:

19

I.

20 Existence of Basin and Boundaries Thereof.

21 There exists in the County of Los Angeles, State of California,  
22 an underground water basin or reservoir known and hereinafter  
23 referred to as "West Coast Basin", "West Basin" or the "Basin",  
24 and the boundaries thereof are described as follows:

25 Commencing at a point in the Baldwin Hills about 1300 feet north  
26 and about 100 feet west of the intersection of Marvale Drive and

27

- 3 -

28



1 Northridge Drive; thence through a point about 200 feet  
2 northeasterly along Northridge Drive from the intersection of  
3 Marvale and Northridge Drives to the base of the escarpment of  
4 the Potrero fault; thence along the base of the escarpment of  
5 the Potrero fault in a straight line passing through a point  
6 about 200 feet south of the intersection of Century and Crenshaw  
7 Boulevards and extending about 2650 feet beyond this point to  
8 the southerly end of the Potrero escarpment; thence from the  
9 southerly end of the Potrero escarpment in a line passing about  
10 700 feet south of the intersection of Western Avenue and  
11 Imperial Boulevard and about 400 feet north of the intersection  
12 of El Segundo Boulevard and Vermont Avenue and about 1700 feet  
13 south of the intersection of El Segundo Boulevard and Figueroa  
14 Street to the northerly end of the escarpment of the Avalon-  
15 Compton fault at a point on said fault about 700 feet west of  
16 the intersection of Avalon Boulevard and Rosecrans Avenue;  
17 thence along the escarpment of the Avalon-Compton fault to a  
18 point in the Dominguez Hills located about 1300 feet north and  
19 about 850 feet west of the intersection of Central Avenue and  
20 Victoria Street; thence along the crest of the Dominguez Hills  
21 in a straight line to a point on Alameda Street about 2900 feet  
22 north of Del Amo Boulevard as measured along Alameda Street;  
23 thence in a straight line extending through a point located on  
24 Del Amo Boulevard about 900 feet west of the Pacific Electric  
25 Railway to a point about 100 feet north and west of the  
26 intersection of Bixby Road and Del Mar Avenue; thence in a

27  
28

1 straight line to a point located about 750 feet west and about  
2 730 feet south of the intersection of Wardlow Road and Long  
3 Beach Boulevard at the escarpment of the Cherry Hill fault;  
4 thence along the escarpment of the Cherry Hill fault through the  
5 intersection of Orange Avenue and Willow Street to a point about  
6 400 feet east of the intersection of Walnut and Creston Avenues;  
7 thence to a point on Pacific Coast Highway about 300 feet west  
8 of its intersection with Obispo Avenue; thence along Pacific  
9 Coast Highway easterly to a point located about 650 feet west of  
10 the intersection of the center line of said Pacific Coast  
11 Highway with the intersection of the center line of Lakewood  
12 Boulevard; thence along the escarpment of the Reservoir Hill  
13 fault to a point about 650 feet north and about 700 feet east of  
14 the intersection of Anaheim Street and Ximeno Avenue; thence  
15 along the trace of said Reservoir Hill fault to a point on the  
16 Los Angeles - Orange County line about 1700 feet northeast of  
17 the Long Beach City limit measured along the County line; thence  
18 along said Los Angeles - Orange County line in a southwesterly  
19 direction to the shore line of the Pacific Ocean; thence in a  
20 northerly and westerly direction along the shore line of the  
21 Pacific Ocean to the intersection of said shore line with the  
22 southerly end of the drainage divide of the Palos Verdes Hills;  
23 thence along the drainage divide of the Palos Verdes Hills to  
24 the intersection of the northerly end of said drainage divide  
25 with the shore line of the Pacific Ocean; thence northerly along  
26 the shore line of the Pacific Ocean to the intersection of said

27  
28

1 shore line with the westerly projection of the crest of the  
2 Ballona escarpment; thence easterly along the crest of the  
3 Ballona escarpment to the mouth of Centinela Creek; thence  
4 easterly from the mouth of Centinela Creek across the Baldwin  
5 Hills in a line encompassing the entire watershed of Centinela  
6 Creek to the point of beginning.

7 All streets, railways and boundaries of Cities and Counties  
8 hereinabove referred to are as the same existed at 12:00 o'clock  
9 noon on August 20, 1961.

10 The area included within the foregoing boundaries is  
11 approximately 101,000 acres in extent.

12 II.

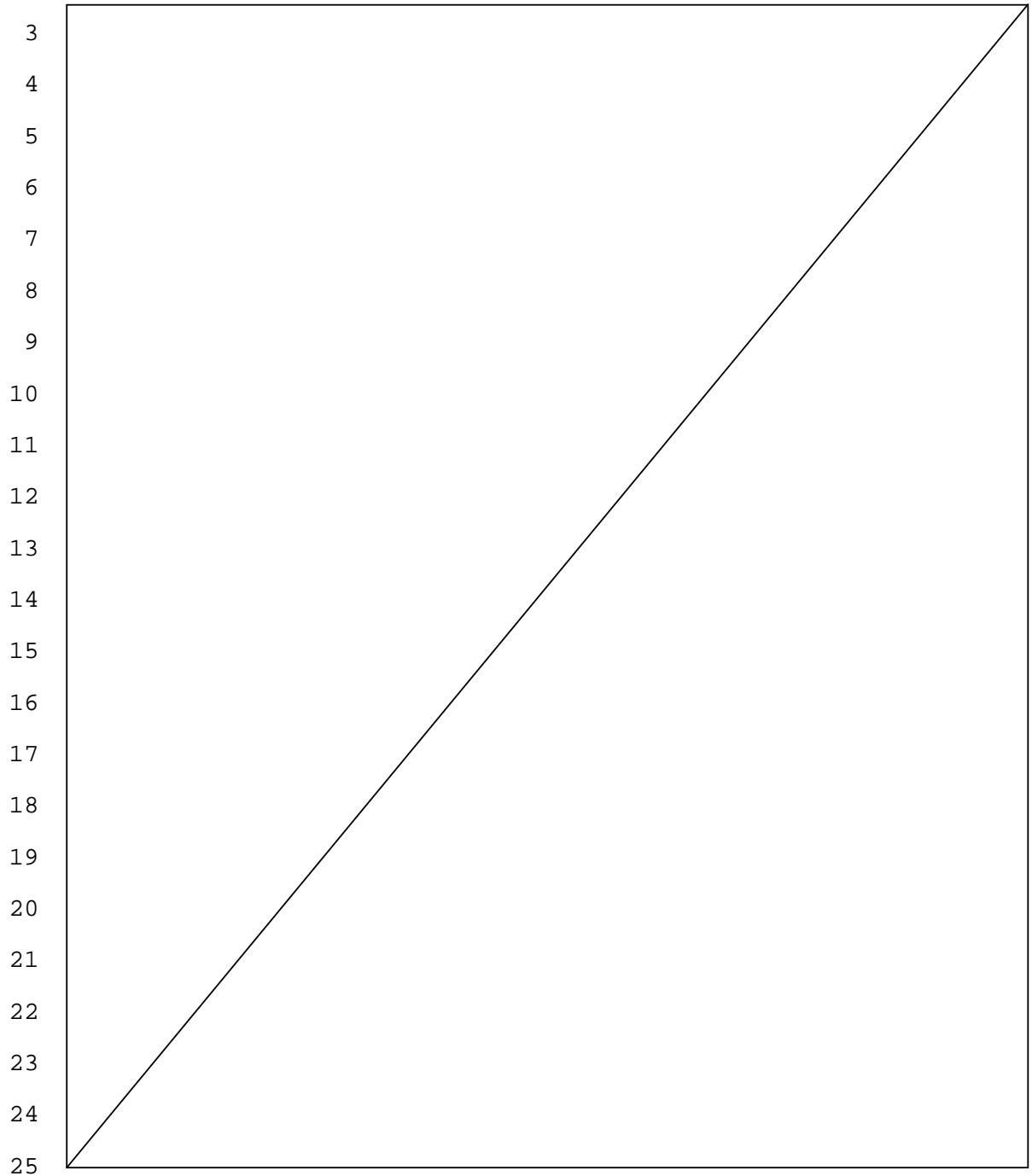
13 Definitions:

- 14 1. Basin, West Coast Basin and West Basin, as these terms are  
15 interchangeably used herein, mean the ground water basin  
16 underlying the area described in Paragraph I hereof.
- 17 2. A fiscal year, as that term is used herein, is a twelve  
18 month period beginning July 1 and ending June 30.
- 19 3. A water purveyor, as that term is used in Paragraph XII  
20 hereof, means a party which sells water to the public,  
21 whether a regulated public utility, mutual water company or  
22 public entity, which has a connection or connections for  
23 the taking of imported water through The Metropolitan Water  
24 District of Southern California, through West Basin  
25 Municipal Water District, or access to such imported water  
26 through such connection, and which normally supplies at

27  
28



1 required, to preserve said Basin as a common source of water  
2 supply.



26  
27  
28

1	<u>PARTY</u>	<u>ADJUDICATED RIGHT IN</u>	
2	<u>AND SUCCESSOR, IF ANY</u>	<u>ACRE FEET, ANNUALLY</u>	
3	LERMENS, EVELYN		0.7
4	(Formerly Alfred Lermens)		
5	LENZINER, EMMA L. sued as		1.4
6	Mrs. E.L. Leuziner		
7	LINDERMAN, ABRAHAM		0
8	Second West Coast Basin Judgment		
9	LISTON, LAWRENCE	0.7	0
10	Sold to R. Harris and L. Harris	-0.7	
11	LITTLE, WILLIAM	0.1	0
12	Sold to Watt Industrial Properties	-0.1	
13	LIZZA, PAT		0
14	LOCHMAN, ERNEST C.		0
15	LOCHMAN, WALTER		
	Second West Coast Basin Judgment		
16	LONG, BEN		0
17	Persilla Long, sued as Pricilla Long		
18	LONG, JOHN		0
19	LONG BEACH, CITY OF		0.7
20	LOPEZ, FRANK		3.7
21	LOPEZ, MANUEL		0
22	one Rudolph E. Lopez		
23	LOS ANGELES, CITY OF		1503.0
24	LOS ANGELES CITY SCHOOL DISTRICT		0
25	LOS ANGELES COUNTY (ALONDRA PARK)	28.7	67.7
26	Successor to Los Angeles		
	County Flood Control District	39.0	
27			
28			

1 LAGERLOF, SENICAL, DRESCHER & SWIFT  
2 301 North Lake Avenue, 10th Floor  
3 Pasadena, California 91101  
4 (818) 793-9400 or (213) 385-4345

5  
6  
7

8 SUPERIOR COURT OF THE STATE OF CALIFORNIA  
9 FOR THE COUNTY OF LOS ANGELES

10

11	CENTRAL AND WEST BASIN WATER	)	No. 786,656
	REPLENISHMENT DISTRICT, etc.,	)	<u>SECOND AMENDED</u>
		)	<u>JUDGMENT</u>
12		)	
		)	Plaintiff,)
13	v.	)	(Declaring and establishing water rights in
		)	Central Basin and enjoining extractions
		)	therefrom in excess of specified quantities.)
14	CHARLES E. ADAMS, et al.,	)	
		)	
15		)	Defendants.)
		)	
16	CITY OF LAKEWOOD, a municipal	)	
	corporation,	)	
17		)	
		)	Cross-Complaint,)
18		)	
		)	
19	v.	)	
		)	
20	CHARLES E. ADAMS, et al.,	)	
		)	
		)	Cross-Defendants.)
21		)	

22

23 The above-entitled matter duly and regularly came on for trial in Department 73  
24 of the above-entitled Court (having been transferred thereto from Department 75 by order of the  
25 presiding Judge), before the Honorable Edmund M. Moor, specially assigned Judge, on May 17,  
26 1965, at 10:00 a.m. Plaintiff was represented by its attorneys BEWLEY, KNOOP,

27

SB 257081 v1: 06774.0096

28

1 LASSLEBEN & WHELAN, MARTIN E. WHELAN, JR., and EDWIN H. VAIL, JR., and cross-  
2 complainant was represented by its attorney JOHN S. TODD. Various defendants and cross-  
3 defendants were also represented at the trial. Evidence both oral and documentary was  
4 introduced. The trial continued from day to day on May 17, 18, 19, 20, 21 and 24, 1965, at  
5 which time it was continued by order of Court for further trial on August 25, 1965, at 10:00 a.m.  
6 in Department 73 of the above-entitled Court; whereupon, having then been transferred to  
7 Department 74, trial was resumed in Department 74 on August 25, 1965, and then continued to  
8 August 27, 1965 at 10:00 a.m. in the same Department. On the latter date, trial was concluded  
9 and the matter submitted. Findings of fact and conclusions of law have heretofore been signed  
10 and filed. Pursuant to the reserved and continuing jurisdiction of the court under the judgment  
11 herein, certain amendments to said judgment and temporary orders have heretofore been made  
12 and entered. Continuing jurisdiction of the court for this action is currently assigned to HON.  
13 FLORENCE T. PICKARD. Motion of Plaintiff herein for further amendments to the judgment,  
14 notice thereof and of the hearing thereon having been duly and regularly given to all parties,  
15 came on for hearing in Department 38 of the above-entitled court on MAY 6, 1991 at 8:45 a.m.  
16 before said HONORABLE PICKARD. Plaintiff was represented by its attorneys LAGERLOF,  
17 SENEAL, DRESCHER & SWIFT, by William F. Kruse. Various defendants were represented  
18 by counsel of record appearing on the Clerk's records. Hearing thereon was concluded on that  
19 date. The within "Second Amended Judgment" incorporates amendments and orders heretofore  
20 made to the extent presently operable and amendments pursuant to said last mentioned motion.  
21 To the extent this Amended judgment is a restatement of the judgment as heretofore amended, it  
22 is for convenience in incorporating all matters in one document, is not a readjudication of such  
23 matters and is not intended to reopen any such matters. As used hereinafter the word "judgment"  
24 shall include the original judgment as amended to date. In connection with the following  
25 judgment, the following terms, words, phrases and clauses are used by the Court with the

26  
27  
28



1 following meanings:

2                   "Administrative Year" means the water year until operation under the judgment is  
3 converted to a fiscal year pursuant to Paragraph 4, Part I, p. 53 hereof, whereupon it shall mean  
4 a fiscal year, including the initial 'short fiscal year' therein provided.

5                   "Allowed Pumping Allocation" is that quantity in acre feet which the Court  
6 adjudges to be the maximum quantity which a party should be allowed to extract annually from  
7 Central Basin as set forth in part I hereof, which constitutes 80% of such party's Total Water  
8 Right.

9                   "Allowed Pumping Allocation for a particular Administra- tive year" and "Allowed  
10 Pumping Allocation in the following Administrative year" and similar clauses, mean the  
11 Allowed Pumping Allocation as increased in a particular Administrative year by an authorized  
12 carryovers pursuant to Part III, Subpart A of this judgment and as reduced by reason of any over-  
13 extractions in a previous Administrative year.

14                   "Artificial Replenishment" is the replenishment of Central Basin achieved through the  
15 spreading of imported or reclaimed water for percolation thereof into Central Basin by a govern-  
16 mental agency.

17                   "Base Water Right" is the highest continuous extractions of water by a party from Central  
18 Basin for a beneficial use in any period of five consecutive years after the commencement of  
19 over-draft in Central Basin and prior to the commencement of this action, as to which there has  
20 been no cessation of use by that party during any subsequent period of five consecutive years.  
21 As employed in the above definition, the words "extractions of water by a party" and "cessation  
22 of use by that party" include such extractions and cessations by any predecessor or predecessors  
23 in interest.

24                   "Calendar Year" is the twelve month period commencing January 1 of each year and  
25 ending December 31 of each year.

26

27

28

1           "Central Basin" is the underground water basin or reservoir underlying Central Basin  
2 Area, the exterior boundaries of which Central Basin are the same as the exterior boundaries of  
3 Central Basin Area.

4           "Central Basin Area" is the territory described in Appendix "1" to this judgment, and is a  
5 segment of the territory comprising Plaintiff District.

6           "Declared water emergency" shall mean a period commencing with the adoption of a  
7 resolution of the Board of Directors of the Central and West Basin Water Replenishment District  
8 declaring that conditions within the Central Basin relating to natural and imported supplies of  
9 water are such that, without implementation of the water emergency provision of this Judgment,  
10 the water resources of the Central Basin risk degradation. In making such declaration, the Board  
11 of Directors shall consider any information and requests provided by water producers, purveyors  
12 and other affected entities and may, for that purpose, hold a public hearing in advance of such  
13 declaration. A Declared Water Emergency shall extend for one (1) year following such  
14 resolution, unless sooner ended by similar resolution.

15           "Extraction", "extractions", "extracting", "extracted", and other variations of the same  
16 noun and verb, mean pumping, taking, diverting or withdrawing ground water by any manner or  
17 means whatsoever from Central Basin.

18           "Fiscal year" is the twelve (12) month period July 1 through June 30 following.

19           "Imported Water" means water brought into Central Basin Area from a non-tributary  
20 source by a party and any predecessors in interest, either through purchase directly from The  
21 Metropolitan Water District of Southern California or by direct purchase from a member agency  
22 thereof, and additionally as to the Department of Water and Power of the City of Los Angeles,  
23 water brought into Central Basin area by that party by means of the Owens River Aqueduct.

24           "Imported Water Use Credit" is the annual amount, computed on a calendar year basis, of  
25 imported water which any party and any predecessors in interest, who have timely made the

26

27

28

1 required filings under Water Code Section 1005.1, have imported into Central Basin Area in any  
2 calendar year and subsequent to July 9, 1951, for beneficial use therein, but not exceeding the  
3 amount by which that party and any predecessors in interest reduces his or their extractions of  
4 ground water from Central Basin in that calendar year from the level of his or their extractions in  
5 the preceding calendar year, or in any prior calendar year not earlier than the calendar year 1950,  
6 whichever is the greater.

7        "Natural Replenishment" means and includes all processes other than "Artificial  
8 Replenishment" by which water may become a part of the ground water supply of Central Basin.

9        "Natural Safe Yield" is the maximum quantity of ground water, not in excess of the long  
10 term average annual quantity of Natural Replenishment, which may be extracted annually from  
11 Central Basin without eventual depletion thereof or without otherwise causing eventual  
12 permanent damage to Central Basin as a source of ground water for beneficial use, said  
13 maximum quantity being determined without reference to Artificial Replenishment.

14        "Overdraft" is that condition of a ground water basin resulting from extractions in any  
15 given annual period or periods in excess of the long term average annual quantity of Natural  
16 Replenishment, or in excess of that quantity which may be extracted annually without otherwise  
17 causing eventual permanent damage to the basin.

18        "Party" means a party to this action. Whenever the term "party" is used in  
19 connection with a quantitative water right, or any quantitative right, privilege or obligation, or in  
20 connection with the assessment for the budget of the Watermaster, it shall be deemed to refer  
21 collectively to those parties to whom are attributed a Total Water Right in Part I of this  
22 judgment.

23        "Person" or "persons" include individuals, partner-ships, associations,  
24 governmental agencies and corporations, and any and all types of entities.

25        "Total Water Right" is the quantity arrived at in the same manner as in the  
26

26

27

28

1 computation of "Base Water Right", but including as if extracted in any particular year the  
2 Imported Water Use Credit, if any, to which a particular party may be entitled.

3           "Water" includes only non-saline water, which is that having less than 1,000 parts  
4 of chlorides to 1,000,000 parts of water.

5           "Water Year" is the 12-month period commencing October 1 of each year and  
6 ending September 30th of the following year.

7           In those instances where any of the above-defined words, terms, phrases or  
8 clauses are utilized in the definition of any of the other above-defined words, terms, phrases and  
9 clauses, such use is with the same meaning as is above set forth.

10

11           NOW THEREFORE, IT IS ORDERED, DECLARED, ADJUDGED AND  
12 DECREED WITH RESPECT TO THE ACTION AND CROSS-ACTION AS FOLLOWS:

13           I. DECLARATION AND DETERMINATION OF WATER RIGHTS OF  
14 PARTIES; RESTRICTION ON THE EXERCISE THEREOF.<sup>1</sup>

15           1. Determination of Rights of Parties.

16           (a) Each party, except defendants, The City of Los Angeles and Department of  
17 Water and Power of the City of Los Angeles, whose name is hereinafter set forth in the  
18 tabulation at the conclusion of Subpart 3 of Part 1, and after whose name there appears under the  
19 column "Total Water Right" a figure other than "0", was the owner of and had the right to extract  
20 annually groundwater from Central Basin for beneficial use in the quantity set forth after that  
21 party's name under said column "Total Water Right" pursuant to the Judgment as originally  
22 entered herein. Attached hereto as Appendix "2" and by this reference made a part hereof as  
23 though fully set forth are the water rights of parties and successors in interest as they existed as

24

---

25           <sup>1</sup>headings in the judgment are for purposes of reference and the language of said headings  
26 do not constitute, other than for such purpose, a portion of this judgment.

27

28

1 of the close of the water year ending September 30, 1978 in accordance with the Watermaster  
2 Reports on file with this Court and the records of the Plaintiff. This tabulation does not take into  
3 account additions or subtractions from any Allowed Pumping Allocation of a producer for the  
4 1978-79 water year, nor other adjustments not representing change in fee title to water rights,  
5 such as leases of water rights, nor does it include the names of lessees of landowners where the  
6 lessees are exercising the water rights. The exercise of all water rights is subject, however, to the  
7 provisions of this Judgment is hereinafter contained. All of said rights are of the same legal  
8 force and effect and are without priority with reference to each other. Each party whose name is  
9 hereinafter set forth in the tabulation set forth in Appendix "2" of this judgment, and after whose  
10 name there appears under the column "Total Water Right" the figure "0" owns no rights to  
11 extract any ground water from Central Basin, and has no right to extract any ground water from  
12 Central Basin.

13 (b) Defendant The City of Los Angeles is the owner of the right to extract fifteen  
14 thousand (15,000) acre feet per annum of ground water from Central Basin. Defendant  
15 Department of Water and Power of the City of Los Angeles has no right to extract ground water  
16 from Central Basin except insofar as it has the right, power, duty or obligation on behalf of  
17 defendant The City of Los Angeles to exercise the water rights in Central Basin of defendant The  
18 City of Los Angeles. The exercise of said rights are subject, however, to the provisions of this  
19 judgment hereafter contained, including but not limited to, sharing with other parties in any  
20 subsequent decreases or increases in the quantity of extractions permitted from Central Basin,  
21 pursuant to continuing jurisdiction of the Court, on the basis that fifteen thousand (15,000) acre  
22 feet bears to the Allowed Pumping Allocations of the other parties.

23 (c) No party to this action is the owner of or has any right to extract ground water  
24 from Central Basin except as herein affirmatively determined.

25 2. Parties Enjoined as Regards Quantities of Extractions.

26  
27  
28

1 (a) Each party, other than The State of California and The City of Los Angeles  
2 and Department of Water and Power of The City of Los Angeles, is enjoined and  
3 restrained in any Administrative year commencing after the date this judgment becomes  
4 final from extracting from Central Basin any quantity of Water greater than the party's  
5 Allowed Pumping Allocation as hereinafter set forth next to the name of the party in the  
6 tabulation appearing in Appendix 2 at the end of this Judgment, subject to further  
7 provisions of this judgment. Subject to such further provisions, the officials, agents and  
8 employees of The State of California are enjoined and restrained in any such  
9 Administrative year from extracting from Central Basin collectively any quantity of  
10 water greater than the Allowed Pumping Allocation of The State of California as  
11 hereinafter set forth next to the name of that party in the same tabulation. Each party  
12 adjudged and declared above not to be the owner of and not to have the right to extract  
13 ground water from Central Basin is enjoined and restrained in any Administrative year  
14 commencing after the date this judgment becomes final from extracting any ground water  
15 from Central Basin, except as may be hereinafter permitted to any such party under the  
16 Exchange Pool provisions of this judgment.

17 (b) Defendant The City of Los Angeles is enjoined and restrained in any  
18 Administrative year commencing after the date this judgment becomes final from  
19 extracting from Central Basin any quantity of water greater than fifteen thousand  
20 (15,000) acre feet, subject to further provisions of this judgment, including but not  
21 limited to, sharing with other parties in any subsequent decreases or increases in the  
22 quantity of extractions permitted from Central Basin by parties, pursuant to continuing  
23 jurisdiction of the Court, on the basis that fifteen thousand (15,000) acre feet bears to the  
24 Allowed Pumping Allocations of the other parties. Defendant Department of Water and  
25 Power of The City of Los Angeles is enjoined and restrained in any  
26 Administrative year commencing after the date this judgment becomes final from







## **Calculating LADWP's 2020 Water Use Target**

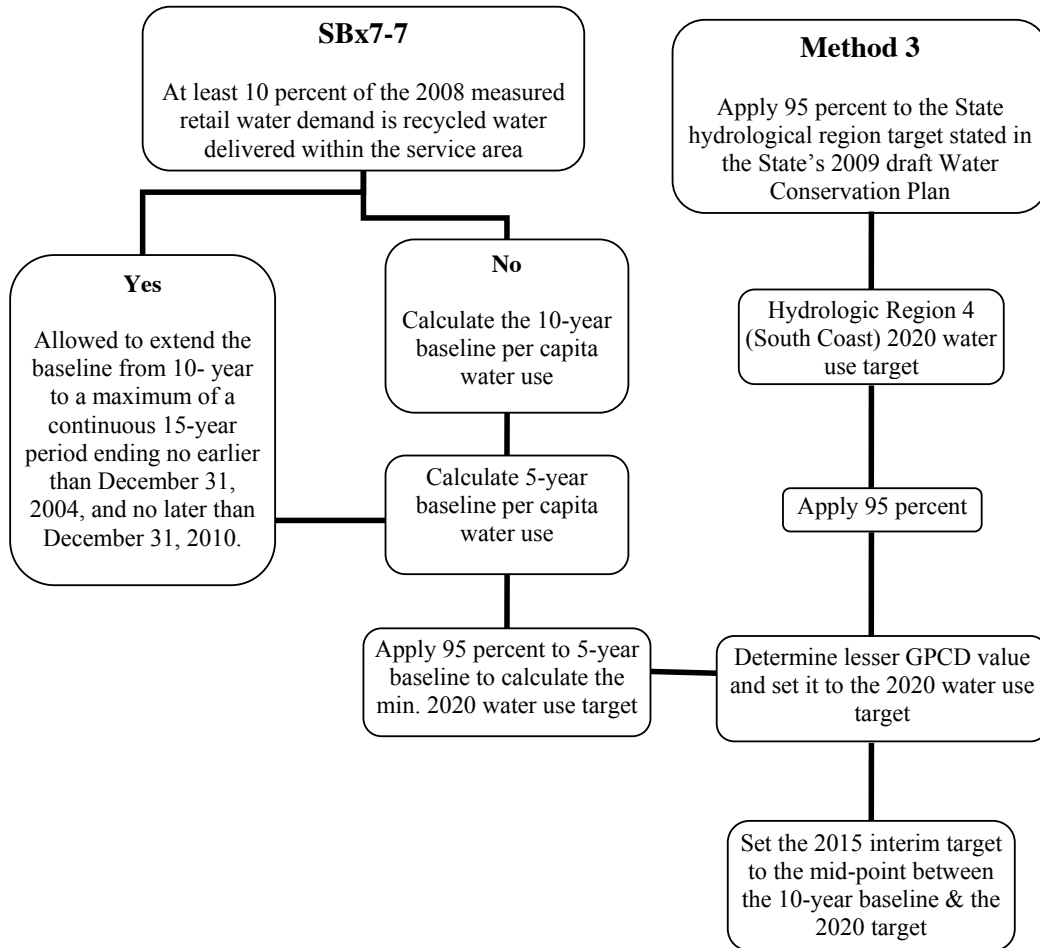


# Calculating LADWP's Baseline and Compliance Urban Per Capita Water Use

## Introduction of Method 3

As an urban retail water supplier, LADWP is required to calculate and report the 2020 water use target and the 2015 interim target in the Urban Water Management Plan. Four methods are stipulated for calculating the 2020 water use target in the Water Conservation Act of 2009, SBX7-7, which is also incorporated in the California Water Code.

LADWP selected Method 3 for the calculation. Using Method 3, 95 percent of the applicable state hydrologic region target, as stated in the State's draft 20x2020 Water Conservation Plan dated April 30, 2009, is set as the 2020 water use target. However, according to California Water Code Section 10608.22, the 2020 water use target shall be no less than 5 percent of the urban retail water supplier's 5-year base daily per capita water use (baseline) if this 5-year baseline is greater than 100 gallons per capita per day (GPCD). The 2015 interim target is the mid-point between the 10- or 15-year baseline and the 2020 water use target. The following flow chart illustrates how to determine the 2020 target and 2015 interim target with Method 3.



## **Determination of Hydrologic Region Water Use Target for LADWP**

LADWP's service area is entirely located in the California State Hydrologic Region 4 – South Coast. As set forth in Table 8 of the State's draft 20x2020 Water Conservation Plan dated April 30, 2009, the 2020 water use target of Hydrologic Region 4 is 149 GPCD. LADWP's hydrologic region target is 142 GPCD or 95 percent of 149 GPCD.

Hydrologic Region Interim Target (2015)	165 GPCD
Hydrologic Region Target (2020)	149 GPCD
95% of the Hydrologic Region 4 Target	142 GPCD

## **LADWP's Base Daily Per Capita Water Use (Baseline)**

As defined in California Water Code Section 10608.12 (b), the baseline is the average gross water use expressed in GPCD and calculated over a continuous, multiyear base period. The 10- or 15-year baseline shall be a continuous period ending no earlier than December 31, 2004, and no later than December 31, 2010.

For an urban retail water supplier that meets at least 10 percent of its 2008 measured retail water demand through recycled water, it has the option of using a 10-year period plus up to an additional 5 years to a maximum of 15-year period for baseline calculation. LADWP can only use the 10-year baseline since it does not meet this requirement.

The 5-year baseline is also calculated for determining the minimum water use reduction requirement if the 5-year baseline is greater than 100 GPCD per Section 10608.22. The 5-year baseline shall be a continuous period ending no earlier than December 31, 2007, and no later than December 31, 2010.

### ***Gross Water Use***

As defined in Section 10608.12 (g), LADWP's gross water use is the total volume of water entering the distribution system excluding the recycled water. All 4 LADWP's water sources: Los Angeles Aqueduct, local groundwater, MWD water, and recycled water, are metered before entering the distribution system.

$$\text{Gross Water Use} = \text{LAA deliveries} + \text{Local Groundwater} + \text{MWD Water} \\ \text{or Total Water Supplies} - \text{Recycled Water}$$

### ***Service Area Population***

LADWP's service area population is based on the city-level population estimates published by State of California, Department of Finance (DOF) in *E-8 Historical Population and Housing Estimates for Cities, Counties and the State, 1990-2000, August 2007* and *E-4 Population Estimates for Cities, Counties and the State, 2001-2010, with 2000 Benchmark, May 2010*. The service area population is adjusted from the City population by adding approximately 28,000 persons who live outside the City limits but within LADWP's service area, and reducing approximately 2,000 persons who live within the City limits but outside LADWP's service area.

$$\text{Service Area Population} = \text{City Population (DOF)} + 28,000 - 2,000$$

### ***LADWP's 10-Year Baseline***

LADWP's 10-year baseline is calculated at 152 GPCD for the 10-year period beginning July 1, 1995 and ending June 30, 2005. It is used to determine the minimum water use reduction requirement per Section

10608.22. The following table shows the source data and the calculated annual GPCD for the 10-year period.

Fiscal Year Ending June 30	Total Water Supply (Acre-Feet) <sup>1</sup>	Recycled Water (Acre-Feet) <sup>1</sup>	Gross Water Use	City Population per DOF <sup>2</sup>	Service Area Population <sup>3</sup>	GPCD
1996	612,164	2,020	610,144	3,542,651	3,568,651	153
1997	630,013	1,747	628,265	3,558,227	3,584,227	156
1998	588,847	1,449	587,398	3,587,170	3,613,170	145
1999	621,063	1,596	619,467	3,627,878	3,653,878	151
2000	661,106	1,984	659,121	3,679,600	3,705,600	159
2001	659,955	2,082	675,873	3,744,806	3,770,806	156
2002	669,051	1,907	667,145	3,803,677	3,829,677	156
2003	652,299	1,635	650,664	3,855,069	3,881,069	150
2004	690,266	2,053	688,213	3,899,129	3,925,129	157
2005	615,572	1,500	614,072	3,929,022	3,955,022	139

<sup>1</sup> Operation records are based on meter reads.

<sup>2</sup> Per DOF E-8 Historical Population and Housing Estimates for Cities, Counties and the State, 1990-2000, August 2007 and E-4 Population Estimates for Cities, Counties and the State, 2001-2010, with 2000 Benchmark, May 2010.

<sup>3</sup> Adjustments made to reflect the addition of approximately 28,000 persons who live outside City limits but within Water System service area, and the reduction of approximately 2,000 persons who live within the City limits but outside LADWP's service area.

10-Year Baseline between FYE 1996-2005	152 GPCD
--	----------

### LADWP's 5-Year Baseline

The 5-year baseline is calculated at 145 GPCD for the 5-year period beginning July 1, 2004 and ending June 30, 2008. It is used to determine the minimum water use reduction requirement per Section 10608.22. The following table shows the source data and the calculated annual GPCD for the 5-year period.

Fiscal Year Ending June 30	Total Water Supply (Acre-Feet) <sup>1</sup>	Recycled Water (Acre-Feet) <sup>1</sup>	Gross Water Use	City Population per DOF <sup>2</sup>	Service Area Population <sup>3</sup>	GPCD
2004	690,266	2,053	688,213	3,899,129	3,925,129	157
2005	615,572	1,500	614,072	3,929,022	3,955,022	139
2006	627,612	1,417	626,194	3,960,385	3,986,385	140
2007	670,181	5,151	665,030	3,980,145	4,006,145	148
2008	649,822	4,181	645,641	4,016,085	4,042,085	143

<sup>1</sup> Operation records are based on meter reads.

<sup>2</sup> Per DOF E-8 Historical Population and Housing Estimates for Cities, Counties and the State, 1990-2000, August 2007 and E-4 Population Estimates for Cities, Counties and the State, 2001-2010, with 2000 Benchmark, May 2010.

<sup>3</sup> Adjustments made to reflect the addition of approximately 28,000 persons who live outside City limits but within Water System service area, and the reduction of approximately 2,000 persons who live within the City limits but outside LADWP's service area.

5-Year Baseline between FYE 2004-2008	145 GPCD
---------------------------------------	----------

### **The 2020 Water Use Target and the 2015 Interim Water Use Target**

According to California Water Code Section 10608.22, LADWP's 2020 water use target of 142 GPCD based on 95 percent of the hydrologic region target, shall be no less than 5 percent of the 5-year baseline of 145 GPCD, which is 138 GPCD. Therefore, LADWP's 2020 water use target shall be 138 GPCD. The 2015 interim target is the mid-point between the 10-year baseline of 152 GPCD and the 2020 water use target of 138 GPCD and is calculated at 145 GPCD per Section 10608.12 (j).

95% of the Hydrologic Region 4 Target	142 GPCD
95% of 5-Year Baseline	138 GPCD
<b>2020 Target = the lesser of the two above</b>	<b>138 GPCD</b>
10-Year Baseline	152 GPCD
<b>2015 Interim Target = the midpoint between 10-Year Baseline &amp; 2020 Target</b>	<b>145 GPCD</b>

# **CUWCC Biennial Reports**





# **BMP Coverage Status Report 2007-2008**

# BMP 1 Coverage Requirement Status

Reporting Unit ID 152

Rep Unit Name:  
Los Angeles Dept. of Water and Power

Date MOU Signed:  
9/12/1991

Reporting Period:  
07-08

Rep Unit Category:  
Retail Only

RU indicated "At least as effective as" implementation during report period: No

RU filed an exemption for this BMP during report period: No exemption request filed

If exemption filed, type: \_\_\_\_\_

## Exhibit 1 Coverage Requirement

An agency must meet three conditions to satisfy strict compliance for BMP 1.

Condition 1: Adopt survey targeting and marketing strategy on time

Condition 2: Offer surveys to 20% of SF accounts and 20% of MF units during report period

Condition 3: Be on track to survey 15% of SF accounts and 15% of MF units within 10 years of implementation start date.

### Test For Condition 1

Latest Year RU to Implement Targeting/Marketing Program: 1999

Single Family	Multi Family
---------------	--------------

Year RU Reported Implementing Targeting/Marketing Program: 1990 1990

RU Met Targeting/Marketing Coverage Requirement: Yes Yes

### Test For Condition 2

Latest Year Survey Program to Start: 1998

Res Survey Offers (%) 2.69% 1.73%

Single Family	Multi Family
---------------	--------------

Select a Reporting Period: 07-08

Survey Offers 20% No No

### Test For Condition 3

#### Completed Residential Surveys

Single Family	Multi Family
---------------	--------------

Total Completed Surveys through 2008 46,796 169,066

Credit for Surveys Completed Prior to Implementation of Reporting Database 53,384 67,216

Total + Credit 100,180 236,282

Res. Accounts in Base Year 464,661 724,199

RU Survey Coverage as % of Base Year Res Accounts 21.56% 32.63%

Coverage Requirement by Year 10 of Implementation per Exhibit 1 13.50% 13.50%

RU on Schedule to Meet 10 Year Coverage Requirement Yes Yes

## BMP 1 Coverage Status Summary

Water supplier has met the coverage requirements for this BMP.

# BMP 2 Coverage Requirement Status

Reporting Unit ID:  Rep Unit Name: [Los Angeles Dept. of Water and Power](#)

Date MOU Signed: 9/12/1991 Reporting Period: 07-08 Rep Unit Category: Retail Only

RU indicated "At least as effective as" implementation during report period: No

RU filed an exemption for this BMP during report period: No exemption request filed  
 If exemption filed, type: \_\_\_\_\_

## Exhibit 1 Coverage Requirement

An agency must meet **one** of three conditions to satisfy strict compliance for BMP 2.

Condition 1: The agency has demonstrated that 75% of SF accounts and 75% of MF units constructed prior to 1992 are fitted with low-flow showerheads.

Condition 2: An enforceable ordinance requiring the replacement of high-flow showerheads and other water use fixtures with their low-flow counterparts is in place for the agency's service area.

Condition 3: The agency has distributed or directly installed low-flow showerheads and other low-flow plumbing devices to not less than 10% of single-family accounts and 10% of multi-family units constructed prior to 1992 during the reporting period.

### Test For Condition 1

Report Year	Report Period	Single Family		Multi Family		
		Reported Saturation	Saturation 75%?	Reported Saturation	Saturation 75%?	
1999	99-00	99	Yes	99	Yes	▲
2000	99-00	99	Yes	99	Yes	
2001	01-02	99	Yes	99	Yes	
2002	01-02	99	Yes	99	Yes	
2003	03-04	99	Yes	99	Yes	
2004	03-04	99	Yes	99	Yes	
2005	05-06	99	Yes	99	Yes	
2006	05-06	99	Yes	99	Yes	
2007	07-08	99	Yes	99	Yes	
2008	07-08	99	Yes	99	Yes	▼

# BMP 2 Coverage Requirement Status

---

## Test For Condition 2

RU has ordinance  
requiring showerhead  
retrofit?

Report Year	Report Period	
1999	99-00	Yes
2000	99-00	Yes
2001	01-02	Yes
2002	01-02	Yes
2003	03-04	Yes
2004	03-04	Yes
2005	05-06	Yes
2006	05-06	Yes
2007	07-08	Yes
2008	07-08	Yes

## Test For Condition 3

1992 SF Accounts	Num. Showerheads Distributed to SF Accounts	Single Family Coverage Ratio	SF Coverage Ratio 10%
<u>462,000</u>	<u>11,506</u>	<u>2.5%</u>	<u>No</u>
1992 MF Accounts	Num. Showerheads Distributed to MF Accounts	Multi Family Coverage Ratio	MF Coverage Ratio 10%
<u>710,000</u>	<u>37,083</u>	<u>5.2%</u>	<u>No</u>

---

## BMP 2 Coverage Status Summary

Water supplier has met the coverage requirements for this BMP.

---

# BMP 3 Coverage Requirement Status

Reporting Unit ID

Rep Unit Name: Los Angeles Dept. of Water and Power

Date MOU Signed: 9/12/1991

Reporting Period: 07-08

Rep Unit Category: Retail Only

RU indicated "At least as effective as" implementation during report period: No

RU filed an exemption for this BMP during report period: No exemption request filed  
 If exemption filed, type: \_\_\_\_\_

## Exhibit 1 Coverage Requirement

An agency must meet one of two conditions to be in compliance with BMP 3:

Condition 1: Perform a prescreening audit. If the result is equal to or greater than 0.9 nothing more needs be done.

Condition 2: Perform a prescreening audit. If the result is less than 0.9, perform a full audit in accordance with AWWA's Manual of Water Supply Practices, Water Audits, and Leak Detection.

RU operates a water distribution system: Yes

## Tests For Conditions 1 and 2

Report Year	Report Period	Pre Screen Completed	Pre Screen Result	Full Audit Indicated	Full Audit Completed
1999	99-00	Yes	93.8%	No	No
2000	99-00	Yes	91.8%	No	No
2001	01-02	No			No
2002	01-02	No			No
2003	03-04	No			No
2004	03-04	No			No
2005	05-06	No			No
2006	05-06	No			No
2007	07-08	Yes	95.2%	No	No
2008	07-08	Yes	94.3%	No	No

## BMP 3 Coverage Status Summary

Water supplier has met the coverage requirements for this BMP.

# BMP 4 Coverage Requirement Status

---

Reporting Unit ID  Rep Unit Name: Los Angeles Dept. of Water and Power

Date MOU Signed: 9/12/1991 Reporting Period: 07-08 Rep Unit Category: Retail Only

RU indicated "At least as effective as" implementation during report period: No

RU filed an exemption for this BMP during report period: No exemption request filed  
If exemption filed, type: \_\_\_\_\_

## Exhibit 1 Coverage Requirement

For agencies signing the MOU prior to December 31, 1997:

100% of existing unmetered accounts to be metered and billed by volume of use by July 1, 2009.

For agencies signing the MOU after December 31, 1997:

100% of existing unmetered accounts to be metered and billed by volume of use by July 1, 2012  
OR within six years of signing the MOU (whichever date is later). All retrofits must be completed no later than one year prior to the requirements of state law (January 1, 2025).

## Tests For Compliance

Total Meter Retrofits Reported through 2008	<u>0</u>
No. of Unmetered Accounts in Base Year	<u>159</u>
Meter Retrofit Coverage as % of Base Year Unmetered Accounts	<u>0.0%</u>
Coverage Requirement by Year 10 of Implementation	<input type="text" value="90.0%"/>
RU on Schedule to Meet 10 Year Coverage Requirement	<u>Yes</u>

---

## BMP 4 Coverage Status Summary

Water supplier has met the coverage requirements for this BMP.

---

# BMP 5 Coverage Requirement Status

Reporting Unit ID

Rep Unit Name: Los Angeles Dept. of Water and Power

Date MOU Signed: 9/12/1991

Reporting Period: 07-08

Rep Unit Category: Retail Only

RU filed an exemption for this BMP during report period: No exemption request filed  
 If exemption filed, type: \_\_\_\_\_

RU indicated "At least as effective as" implementation during report period: Yes

**Exhibit 1 Coverage Requirement**

An agency must meet three conditions to comply with BMP 5.

Condition 1: Develop water budgets for 90% of its dedicated landscape meter accounts within four years of the date implementation is to start.

Condition 2: (a) Offer landscape surveys to at least 20% of its CII accounts with mixed use meters each report cycle and be on track to survey at least 15% of its CII accounts with mixed use meters within 10 years of the date implementation is to start OR (b) Implement a dedicated landscape meter retrofit program for CII accounts with mixed use meters or assign landscape budgets to mixed use meters.

Condition 3: Implement and maintain customer incentive program(s) for irrigation equipment retrofits.

## Test For Condition 1

Report Year	Report Period	BMP 5 Implementation Year	No. of Irrigation Meter Accounts	No. of Irrigation Accounts with Budgets	Budget Coverage Ratio	90% Coverage Met by Year 4
1999	99-00	0	952	37	0.04	NA
2000	99-00	1	1198	118	0.10	NA
2001	01-02	2	949	132	0.14	NA
2002	01-02	3	949	175	0.18	NA
2003	03-04	4	955	249	0.26	No
2004	03-04	5	956	250	0.26	No
2005	05-06	6	879	252	0.29	No
2006	05-06	7	743	256	0.34	No
2007	07-08	8	745	258	0.35	No
2008	07-08	9	766	269	0.35	No

## Test For Condition 2a (survey offers)

Select Reporting Period: 07-08

Large Landscape Survey Offers as % of Mixed Use Meter CII Accounts: 0.0%

Survey Offers Equal or Exceed 20% Coverage Requirement: No

# BMP 5 Coverage Requirement Status

## Test For Condition 2a (surveys completed)

<b>Total Completed Landscape Surveys Reported through 2008</b>	<u>530</u>
Credit for Surveys Completed Prior to Implementation of Reporting Database	<u>114</u>
Total + Credit	<u>644</u>
<b>CII Accounts with Mixed Use Meters in Base Year</b>	<u>74,316</u>
<b>RU Survey Coverage as % of Base Year CII Accounts</b>	<u>0.9%</u>
<b>Coverage Requirement by Year 9 of Implementation per Exhibit 1</b>	<u>11.5%</u>
<b>RU on Schedule to Meet 10 Year Coverage Requirement</b>	<u>No</u>

## Test For Condition 2b (mixed use budget or meter retrofit program)

Report Year	Report Period	BMP 5 Implementation Year	Agency has mix-use budget program	No. of mixed-use budgets
1999	99-00	0	no	0
2000	99-00	1	no	0
2001	01-02	2	no	
2002	01-02	3	no	
2003	03-04	4	no	0
2004	03-04	5	no	0
2005	05-06	6	no	0
2006	05-06	7	no	0
2007	07-08	8	no	0
2008	07-08	9	no	0

Report Year	Report Period	BMP 4 Implementation Year	No. of mixed use CII accounts	No. of mixed use CII accounts fitted with irrig. meters
1999	99-00	1	74500	0
2000	99-00	2	71768	0
2001	01-02	3	76866	0
2002	01-02	4	77165	0
2003	03-04	5	76616	0
2004	03-04	6	77144	0
2005	05-06	7	62479	0
2006	05-06	8	63735	0
2007	07-08	9	60437	0
2008	07-08	10	60327	0



## BMP 5 Coverage Requirement Status

---

### Test For Condition 3

Report Year	Report Period	BMP 5 Implementation Year	RU offers financial incentives?	<u>Loans</u>		<u>Grants</u>		<u>Rebates</u>	
				No.	Total Amount	No.	Total Amount	No.	Total Amount
1999	99-00	0	yes	0	0	0	0	1	1050
2000	99-00	1	yes	0	0	0	0	1	1740
2001	01-02	2	yes	0	0	0	0	4	133900
2002	01-02	3	yes	0	0	31	120000	5	22475
2003	03-04	4	yes	0	0	0	0	2	11624
2004	03-04	5	yes	0	0	0	0	5	21542
2005	05-06	6	yes	0	0	0	0	4	58760
2006	05-06	7	yes	0	0	16	80000	0	0
2007	07-08	8	yes	0	0	0	0	0	0
2008	07-08	9	yes	0	0	0	0	1	8538

---

## BMP 5 Coverage Status Summary

Water supplier has selected an "At Least As Effective As" option for this BMP.

---

# BMP 6 Coverage Requirement Status

Reporting Unit ID  Rep Unit Name: Los Angeles Dept. of Water and Power

Date MOU Signed: 9/12/1991 Reporting Period: 07-08 Rep Unit Category: Retail Only

RU indicated "At least as effective as" implementation during report period: No

RU filed an exemption for this BMP during report period: No exemption request filed  
 If exemption filed, type: \_\_\_\_\_

## Pre-2004 Exhibit 1 Coverage Requirement

An agency must meet one condition to comply with BMP 6.

Condition 1: Offer a cost-effective financial incentive for high-efficiency washers if one or more energy service providers in service area offer financial incentives for high-efficiency washers.

## Revised Exhibit 1 Coverage Requirement

An agency must meet two conditions to comply with BMP 6.

Condition 1: Offer cost-effective financial incentives for high-efficiency washers with Water Factors of 9.5 or less.

Condition 2: Meet Coverage Goal (CG=Total Dwelling Units x 0.0768) by July 1, 2008. Agencies signing the MOU after July 1, 2003, shall have a prorated Coverage Goal, based on implementation period of less than 4.0 years.

### Test For Condition 1

Agency offered cost-effective financial incentives for high-efficiency washers with Water Factors of 9.5 or less: yes

### Test For Condition 2

Coverage Goal:	<u>91,304</u>
Total Coverage Points Awarded (incl. past credit):	<u>110,989</u>
% of Coverage Goal:	<u>121.6%</u>

## **BMP 6 Coverage Status Summary**

Water supplier has met the coverage requirements for this BMP.

# BMP 7 Coverage Requirement Status

Reporting Unit ID

Rep Unit Name:  
[Los Angeles Dept. of Water and Power](#)

Date MOU Signed:  
[9/12/1991](#)

Reporting Period:  
[07-08](#)

Rep Unit Category:  
[Retail Only](#)

RU indicated "At least as effective as" implementation during report period:

RU filed an exemption for this BMP during report period: [No exemption request filed](#)  
If exemption filed, type: \_\_\_\_\_

## Exhibit 1 Coverage Requirement

An agency must meet one condition to comply with BMP 7.

Condition 1: Implement and maintain a public information program consistent with BMP 7's definition.

### Test For Condition 1:07-08

Report Year	Report Period	BMP 7 Implementation Year	RU Has Public Information Program
<a href="#">1999</a>	<a href="#">99-00</a>	1	<a href="#">Yes</a>
<a href="#">2000</a>	<a href="#">99-00</a>	2	<a href="#">Yes</a>
<a href="#">2001</a>	<a href="#">01-02</a>	3	<a href="#">Yes</a>
<a href="#">2002</a>	<a href="#">01-02</a>	4	<a href="#">Yes</a>
<a href="#">2003</a>	<a href="#">03-04</a>	5	<a href="#">Yes</a>
<a href="#">2004</a>	<a href="#">03-04</a>	6	<a href="#">Yes</a>
<a href="#">2005</a>	<a href="#">05-06</a>	7	<a href="#">Yes</a>
<a href="#">2006</a>	<a href="#">05-06</a>	8	<a href="#">Yes</a>
<a href="#">2007</a>	<a href="#">07-08</a>	9	<a href="#">Yes</a>
<a href="#">2008</a>	<a href="#">07-08</a>	10	<a href="#">Yes</a>

## BMP 7 Coverage Status Summary

Water supplier has met the coverage requirements for this BMP.

# BMP 8 Coverage Requirement Status

---

Reporting Unit ID

Rep Unit Name:  
[Los Angeles Dept. of Water and Power](#)

Date MOU Signed:  
[9/12/1991](#)

Reporting Period:  
[07-08](#)

Rep Unit Category:  
[Retail Only](#)

RU indicated "At least as effective as" implementation during report period:   No  

RU filed an exemption for this BMP during report period: [No exemption request filed](#)

If exemption filed, type: \_\_\_\_\_

## Exhibit 1 Coverage Requirement

An agency must meet one condition to comply with BMP 8.

Condition 1: Implement and maintain a school education program consistent with BMP 8's definition.

### Test For Condition 1

Report Year	Report Period	BMP 8 Implementation Year	RU Has School Education Program
1999	99-00	1	Yes
2000	99-00	2	Yes
2001	01-02	3	Yes
2002	01-02	4	Yes
2003	03-04	5	Yes
2004	03-04	6	Yes
2005	05-06	7	Yes
2006	05-06	8	Yes
2007	07-08	9	Yes
2008	07-08	10	Yes

---

## BMP 8 Coverage Status Summary

Water supplier has met the coverage requirements for this BMP.

---

# BMP 9 Coverage Requirement Status

Reporting Unit ID

Rep Unit Name:  
[Los Angeles Dept. of Water and Power](#)

Date MOU Signed:  
9/12/1991

Reporting Period:  
07-08

Rep Unit Category:  
Retail Only

RU indicated "At least as effective as" implementation during report period: No

RU filed an exemption for this BMP during report period: No exemption request filed  
If exemption filed, type: \_\_\_\_\_

## Exhibit 1 Coverage Requirement

An agency must meet two conditions to comply with BMP 9.

Condition 1: Agency has identified and ranked by use commercial, industrial, and institutional accounts.

Condition 2(a): Agency is on track to survey 10% of commercial accounts, 10% of industrial accounts, and 10% of institutional accounts within 10 years of date implementation to commence.

OR

Condition 2(b): Agency is on track to reduce CII water use by an amount equal to 10% of baseline use within 10 years of date implementation to commence.

OR

Condition 2(c): Agency is on track to meet the combined target as described in Exhibit 1 BMP 9 documentation.

### Test For Condition 1

Ranked Commercial Customers **yes**

Ranked Industrial Customers **yes**

Ranked Institutional Customers **yes**

Rank Coverage Met **Yes**

### Test For Condition 2a

	Commercial	Industrial	Institutional
<b>Total Completed Surveys Reported through 2008</b>	<u>248</u>	<u>51</u>	<u>32</u>
Credit for Surveys Completed Prior to Implementation of Reporting Database	<u>32</u>	<u>3</u>	<u>8</u>
Total + Credit	<u>280</u>	<u>54</u>	<u>40</u>
<b>CII Accounts in Base Year</b>	<u>59,649</u>	<u>7,298</u>	<u>7,369</u>
<b>RU Survey Coverage as % of Base Year CII Accounts</b>	<u>0.5%</u>	<u>0.7%</u>	<u>0.5%</u>
<b>Coverage Requirement by Year 9 of Implementation per Exhibit 1</b>	<u>7.7%</u>	<u>7.7%</u>	<u>7.7%</u>
<b>RU on Schedule to Meet 10 Year Coverage Requirement</b>	<u>No</u>	<u>No</u>	<u>No</u>

## BMP 9 Coverage Requirement Status

---

### Test For Condition 2b

Coverage Year	Performance Target Savings (AF/Yr)	Performance Target Savings Coverage	Performance Target Savings Coverage Requirement	Coverage Requirement Met
1999	5,097	3%	0.5%	Yes
2000	8,383	5%	1%	Yes
2001	12,281	8%	1.7%	Yes
2002	16,716	10%	2.4%	Yes
2003	21,743	14%	3.3%	Yes
2004	28,619	18%	4.2%	Yes
2005	29,420	18%	5.3%	Yes
2006	33,135	21%	6.4%	Yes
2007	33,819	21%	7.7%	Yes
2008	34,673	22%	9%	Yes

### Test For Condition 2c

Total BMP 9 Surveys + Credit	<u>374</u>
<b>BMP 9 Survey Coverage</b>	<u>0.5%</u>
<b>BMP 9 Performance Target Coverage</b>	<u>21.7%</u>
<b>BMP 9 Survey + Performance Target Coverage</b>	<u>22.2%</u>
<b>Combined Coverage Equals or Exceeds BMP 9 Survey Coverage Requirement?</b>	<u>Yes</u>

## BMP 9 Coverage Status Summary

Water supplier has met the coverage requirements for this BMP.

---

# BMP 11 Coverage Requirement Status

---

Reporting Unit ID

Rep Unit Name:  
[Los Angeles Dept. of Water and Power](#)

Date MOU Signed:  
[9/12/1991](#)

Reporting Period:  
[07-08](#)

Rep Unit Category:  
[Retail Only](#)

RU indicated "At least as effective as" implementation during report period: [No](#)

RU filed an exemption for this BMP during report period: [No exemption request filed](#)  
If exemption filed, type: \_\_\_\_\_

## Exhibit 1 Coverage Requirement

Agency shall maintain rate structure consistent with BMP 11's definition of conservation pricing.

### Test For Compliance

Fully metered?	Yes
Water Coverage Met?	Yes
Provide Sewer Service?	No
Sewer Coverage Met?	Yes

---

## BMP 11 Coverage Status Summary

Water supplier has met the coverage requirements for this BMP.

---

## BMP 11 Sewer Coverage Status Summary

Agency does not provide sewer service

---

# BMP 12 Coverage Requirement Status

Reporting Unit ID

Rep Unit Name:  
[Los Angeles Dept. of Water and Power](#)

Date MOU Signed:  
[9/12/1991](#)

Reporting Period:  
[07-08](#)

Rep Unit Category:  
[Retail Only](#)

RU indicated "At least as effective as" implementation during report period:   No  

RU filed an exemption for this BMP during report period: [No exemption request filed](#)  
If exemption filed, type: \_\_\_\_\_

## Exhibit 1 Coverage Requirement

Agency shall staff and maintain the position of conservation coordinator and provide support staff as necessary.

### Test For Compliance

Report Year	Report Period	Conservation Coordinator Position Staffed?	Total Staff on Team (incl. CC)
1999	99-00	yes	6
2000	99-00	yes	5
2001	01-02	yes	5
2002	01-02	yes	6
2003	03-04	yes	6
2004	03-04	yes	6
2005	05-06	yes	6
2006	05-06	yes	6
2007	07-08	yes	5
2008	07-08	yes	5

## BMP 12 Coverage Status Summary

Water supplier has met the coverage requirements for this BMP.



# BMP 13 Coverage Requirement Status

Reporting Unit ID

Rep Unit Name: Los Angeles Dept. of Water and Power

Date MOU Signed: 9/12/1991

Reporting Period: 07-08

Rep Unit Category: Retail Only

RU indicated "At least as effective as" implementation during report period: No

RU filed an exemption for this BMP during report period: No exemption request filed  
 If exemption filed, type: \_\_\_\_\_

## Exhibit 1 Coverage Requirement

Implementation methods shall be enacting and enforcing measures prohibiting gutter flooding, single pass cooling systems in new connections, non-recirculating systems in all new conveyer car wash and commercial laundry systems, and non-recycling decorative water fountains.

## Test For Compliance

Agency or service area prohibits:

Report Year	Gutter Flooding	Single-Pass Cooling Systems	Single-Pass Car Wash	Single-Pass Laundry	Single-Pass Fountains	Other	RU has ordinance that meets coverage requirement
1999	yes	no	no	no	yes	yes	No
2000	yes	no	no	no	yes	yes	No
2001	yes	no	no	no	yes	yes	No
2002	yes	no	no	no	yes	yes	No
2003	yes	no	no	no	yes	yes	No
2004	yes	no	no	no	yes	yes	No
2005	yes	no	no	no	yes	yes	No
2006	yes	no	no	no	yes	yes	No
2007	yes	Yes	Yes	Yes	yes	yes	Yes
2008	yes	Yes	Yes	Yes	yes	yes	Yes

## BMP 13 Coverage Status Summary

Water supplier has met the coverage requirements for this BMP.

# BMP 14 Coverage Requirement Status

Reporting Unit ID: 152

Rep Unit Name:  
Los Angeles Dept. of Water and Power

Base Year: 1997

Rep Unit Category:  
Retail Only

## Exhibit 1 Coverage Requirement

An agency must meet one of the following conditions to be in compliance with BMP 14.

Condition 1: Retrofit-on-resale (ROR) in effect in service area

Condition 2: Water savings from toilet replacement programs equal to 90% of Exhibit 6 coverage requirement.

An agency with an exemption for BMP 14 is not required to meet one of the above conditions.

The report treats an agency with missing base year data required to compute the Exhibit 6 coverage requirement as out of compliance with BMP 14.

Coverage Year	BMP 14 Data Submitted to CUWCC	Exemption Filed with CUWCC	ALAEA	ROR Ordinance in Effect	Exhibit 6 Coverage Req't (AF)	Toilet Replacement Program Water Savings (AF)
1999	<input checked="" type="checkbox"/>	<input type="checkbox"/>	<input type="checkbox"/>	<input checked="" type="checkbox"/>	3,511	159,92
2000	<input checked="" type="checkbox"/>	<input type="checkbox"/>	<input type="checkbox"/>	<input checked="" type="checkbox"/>	9,987	188,96
2001	<input checked="" type="checkbox"/>	<input type="checkbox"/>	<input type="checkbox"/>	<input checked="" type="checkbox"/>	18,948	219,42
2002	<input checked="" type="checkbox"/>	<input type="checkbox"/>	<input type="checkbox"/>	<input checked="" type="checkbox"/>	29,980	250,86
2003	<input checked="" type="checkbox"/>	<input type="checkbox"/>	<input type="checkbox"/>	<input checked="" type="checkbox"/>	42,721	282,87
2004	<input checked="" type="checkbox"/>	<input type="checkbox"/>	<input type="checkbox"/>	<input checked="" type="checkbox"/>	56,857	315,57
2005	<input checked="" type="checkbox"/>	<input type="checkbox"/>	<input type="checkbox"/>	<input checked="" type="checkbox"/>	72,115	348,59
2006	<input checked="" type="checkbox"/>	<input type="checkbox"/>	<input type="checkbox"/>	<input checked="" type="checkbox"/>	88,259	381,44
2007	<input checked="" type="checkbox"/>	<input type="checkbox"/>	<input type="checkbox"/>	<input checked="" type="checkbox"/>	105,08	413,69
2008	<input checked="" type="checkbox"/>	<input type="checkbox"/>	<input type="checkbox"/>	<input checked="" type="checkbox"/>	122,41	444,64

## BMP 14 Coverage Status Summary: 2010

Water supplier has met the coverage requirements for this BMP.

# **2007 CUWCC Biennial Report**

**Water Supply & Reuse**

Reporting Unit:  
**Los Angeles Dept. of Water and Power**

Year:  
**2007**

**Water Supply Source Information**

<b>Supply Source Name</b>	<b>Quantity (AF) Supplied</b>	<b>Supply Type</b>
LA Aqueduct	277942	Imported
MWDSC	295602	Imported
Groundwater	88906	Groundwater
Recycled	5186	Recycled
Transfer	1136	Imported
Storage	242	Imported

**Total AF: 669014**

Reported as of 6/10/10

**Accounts & Water Use**

Reporting Unit Name: **Los Angeles Dept. of Water and Power** Submitted to CUWCC **02/08/2009** Year: **2007**

What is the reporting year? Fiscal Month Ending June

**A. Service Area Population Information:**

1. Total service area population 4044080

**B. Number of Accounts and Water Deliveries (AF)**

Type	Metered		Unmetered	
	No. of Accounts	Water Deliveries (AF)	No. of Accounts	Water Deliveries (AF)
1. Single-Family	481908	261323	0	0
2. Multi-Family	123597	188149	0	0
3. Commercial	72130	114298	0	0
4. Industrial	6867	21838	0	0
5. Institutional	7403	48320	0	0
6. Dedicated Irrigation	745	248	0	0
7. Recycled Water	42	6509	0	0
8. Other	0	0	0	0
9. Unaccounted	NA	32080	NA	0
<b>Total</b>	692692	672765	0	0

Metered Unmetered

Reported as of 6/10/10

**BMP 01: Water Survey Programs for Single-Family and Multi-Family Residential Customers**

Reporting Unit: **Los Angeles Dept. of Water and Power** BMP Form Status: **100% Complete** Year: **2007**

**A. Implementation**

- 1. Based on your signed MOU date, 09/12/1991, your Agency STRATEGY DUE DATE is: 09/11/1993
- 2. Has your agency developed and implemented a targeting/marketing strategy for SINGLE-FAMILY residential water use surveys? yes
  - a. If YES, when was it implemented? 06/01/1990
- 3. Has your agency developed and implemented a targeting/marketing strategy for MULTI-FAMILY residential water use surveys? yes
  - a. If YES, when was it implemented? 06/01/1990

**B. Water Survey Data**

Single

<b>Survey Counts:</b>	<b>Family Accounts</b>	<b>Multi-Family Units</b>
1. Number of surveys offered:	12500	12500
2. Number of surveys completed:	5444	9913

**Indoor Survey:**

3. Check for leaks, including toilets, faucets and meter checks	yes	yes
4. Check showerhead flow rates, aerator flow rates, and offer to replace or recommend replacement, if necessary	yes	yes
5. Check toilet flow rates and offer to install or recommend installation of displacement device or direct customer to ULFT replacement program, as necessary; replace leaking toilet flapper, as necessary	yes	yes

**Outdoor Survey:**

6. Check irrigation system and timers	no	no
7. Review or develop customer irrigation schedule	no	no
8. Measure landscaped area (Recommended but not required for surveys)	no	no
9. Measure total irrigable area (Recommended but not required for surveys)	no	no
10. Which measurement method is typically used (Recommended but not required for surveys)		None
11. Were customers provided with information packets that included evaluation results and water savings recommendations?	no	no
12. Have the number of surveys offered and completed, survey results, and survey costs been tracked?	yes	no
a. If yes, in what form are surveys tracked?		database
b. Describe how your agency tracks this information.		

Contractor reporting & invoice support documentation

**C. "At Least As Effective As"**

1. Is your AGENCY implementing an "at least as effective as" variant of this BMP?	No
a. If YES, please explain in detail how your implementation of this BMP differs from Exhibit 1 and why you consider it to be "at least as effective as."	

**D. Comments**

Period: FY 06-07. Interior assessments with installation of devices as needed (ULFTs, showerheads, aerators, flappers). Direct and indirect marketing for MF segment

Reported as of 6/10/10

**BMP 02: Residential Plumbing Retrofit**

Reporting Unit:

**Los Angeles Dept. of Water and Power**      **BMP Form Status: 100% Complete**      **Year: 2007**

**A. Implementation**

- 1. Is there an enforceable ordinance in effect in your service area requiring replacement of high-flow showerheads and other water use fixtures with their low-flow counterparts? yes
  - a. If YES, list local jurisdictions in your service area and code or ordinance in each:
 

City of Los Angeles "Water Closet, Urinal and Showerhead Regulations-Retrofit on Resale" Ordinance (No. 172075)
- 2. Has your agency satisfied the 75% saturation requirement for single-family housing units? yes
- 3. Estimated percent of single-family households with low-flow showerheads: 99%
- 4. Has your agency satisfied the 75% saturation requirement for multi-family housing units? yes
- 5. Estimated percent of multi-family households with low-flow showerheads: 99%
- 6. If YES to 2 OR 4 above, please describe how saturation was determined, including the dates and results of any survey research.

LA enacted an ordinance requiring all LADWP customers to install low flow showerheads & have installations certified or incur financial penalties for non-compliance. 99+% of LADWP customers have demonstrated compliance

**B. Low-Flow Device Distribution Information**

- 1. Has your agency developed a targeting/ marketing strategy for distributing low-flow devices? yes
  - a. If YES, when did your agency begin implementing this strategy? 07/01/1988
  - b. Describe your targeting/ marketing strategy.

Direct mail to all SF customers; element of all survey pgms; req'd per L.A. ordinance; provided upon request to any residential customer; distributed with program ULFTs.

<b>Low-Flow Devices Distributed/ Installed</b>	<b>SF Accounts</b>	<b>MF Units</b>
2. Number of low-flow showerheads distributed:	7694	24187
3. Number of toilet-displacement devices distributed:	3	0
4. Number of toilet flappers distributed:	118	1658
5. Number of faucet aerators distributed:	9395	38148
6. Does your agency track the distribution and cost of low-flow devices?		yes
a. If YES, in what format are low-flow devices tracked?		Database
b. If yes, describe your tracking and distribution system :		

Tracking: in-house inventory control; contractor invoices & support documentation. Distribution: direct install by CBOs; distribution by CBOs & through Conservation office.

**C. "At Least As Effective As"**

- 1. Is your AGENCY implementing an "at least as effective as" variant of this BMP? No

a. If YES, please explain in detail how your implementation of this BMP differs from Exhibit 1 and why you consider it to be "at least as effective as."

**D. Comments**

Direct install accounts for vast majority of devices and cost.  
Showerheads are 2.0 gpm

Reported as of 6/10/10



**BMP 03: System Water Audits, Leak Detection and Repair**

Reporting Unit: **Los Angeles Dept. of Water and Power**      BMP Form Status: **100% Complete**      Year: **2007**

**A. Implementation**

- 1. Does your agency own or operate a water distribution system? yes
- 2. Has your agency completed a pre-screening system audit for this reporting year? Yes
- 3. If YES, enter the values (AF/Year) used to calculate verifiable use as a percent of total production:
  - a. Determine metered sales (AF) 634178
  - b. Determine other system verifiable uses (AF) 0
  - c. Determine total supply into the system (AF) 666258
  - d. Using the numbers above, if (Metered Sales + Other Verifiable Uses) / Total Supply is < 0.9 then a full-scale system audit is required. 0.95
- 4. Does your agency keep necessary data on file to verify the values entered in question 3? yes
- 5. Did your agency complete a full-scale audit during this report year? no
- 6. Does your agency maintain in-house records of audit results or completed AWWA M36 audit worksheets for the completed audit which could be forwarded to CUWCC? yes
- 7. Does your agency operate a system leak detection program? no
  - a. If yes, describe the leak detection program:

**B. Survey Data**

- 1. Total number of miles of distribution system line. 7228
- 2. Number of miles of distribution system line surveyed. 0

**C. "At Least As Effective As"**

- 1. Is your AGENCY implementing an "at least as effective as" variant of this BMP? No
  - a. If YES, please explain in detail how your implementation of this BMP differs from Exhibit 1 and why you consider it to be "at least as effective as."

**D. Comments**

**Voluntary Questions (Not used to calculate compliance)**

---

**E. Volumes**

- |   | <b>Estimated</b> | <b>Verified</b> |
|---|------------------|-----------------|
| 1. Volume of raw water supplied to the system:      |                  |                 |
| 2. Volume treated water supplied into the system:   |                  |                 |
| 3. Volume of water exported from the system:        |                  |                 |
| 4. Volume of billed authorized metered consumption: |                  |                 |

5. Volume of billed authorized unmetered consumption:
6. Volume of unbilled authorized metered consumption:
7. Volume of unbilled authorized unmetered consumption:

## **F. Infrastructure and Hydraulics**

1. System input (source or master meter) volumes metered at the entry to the:
2. How frequently are they tested and calibrated?
3. Length of mains:
4. What % of distribution mains are rigid pipes (metal, ac, concrete)?
5. Number of service connections:
6. What % of service connections are rigid pipes (metal)?
7. Are residential properties fully metered?
8. Are non-residential properties fully metered?
9. Provide an estimate of customer meter under-registration:
10. Average length of customer service line from the main to the point of the meter:
11. Average system pressure:
12. Range of system pressures:

From to

13. What percentage of the system is fed from gravity feed?
14. What percentage of the system is fed by pumping and re-pumping?

## **G. Maintenance Questions**

1. Who is responsible for providing, testing, repairing and replacing customer meters?
2. Does your agency test, repair and replace your meters on a regular timed schedule?
  - a. If yes, does your agency test by meter size or customer category?:
    - Less than or equal to 1"
    - 1.5" to 2"
    - 3" and Larger
  - b. If yes to meter size, please provide the frequency of testing by meter size:
    - Less than or equal to 1"
    - 1.5" to 2"
    - 3" and Larger
  - c. If yes to customer category, provide the frequency of testing by customer category:
    - SF residential
    - MF residential
    - Commercial
    - Industrial & Institutional
3. Who is responsible for repairs to the customer lateral or customer service line?
4. Who is responsible for service line repairs downstream of the customer meter?
5. Does your agency proactively search for leaks using leak

survey techniques or does your utility reactively repair leaks which are called in, or both?

6. What is the utility budget breakdown for:

Leak Detection	\$
Leak Repair	\$
Auditing and Water Loss Evaluation	\$
Meter Testing	\$

**H. Comments**

Reported as of 6/10/10

**BMP 04: Metering with Commodity Rates for all New Connections and Retrofit of Existing**

Reporting Unit: **Los Angeles Dept. of Water and Power**      BMP Form Status: **100% Complete**      Year: **2007**

**A. Implementation**

- 1. Does your agency have any unmetered service connections? No
  - a. If YES, has your agency completed a meter retrofit plan?
  - b. If YES, number of previously unmetered accounts fitted with meters during report year:
- 2. Are all new service connections being metered and billed by volume of use? Yes
- 3. Are all new service connections being billed volumetrically with meters? Yes
- 4. Has your agency completed and submitted electronically to the Council a written plan, policy or program to test, repair and replace meters? Yes

5. Please fill out the following matrix:

Account Type	Number of Metered Accounts	Number of Metered Accounts Read	Number of Metered Accounts Billed by Volume	Billing Frequency Per Year	Number of Volume Estimates
a. Single Family	483433	483433	483433	6	0
b. Multi-Family	121693	121693	121693	6	0
c. Commercial	60327	60327	60327	12	0
d. Industrial	6552	6552	6552	12	0
e. Institutional	6707	6707	6707	12	0
f. Landscape Irrigation	766	766	766	12	0

**B. Feasibility Study**

- 1. Has your agency conducted a feasibility study to assess the merits of a program to provide incentives to switch mixed-use accounts to dedicated landscape meters? no
  - a. If YES, when was the feasibility study conducted? (mm/dd/yy)

b. Describe the feasibility study:

2. Number of CII accounts with mixed-use meters:	60437
3. Number of CII accounts with mixed-use meters retrofitted with dedicated irrigation meters during reporting period.	0

### C. "At Least As Effective As"

1. Is your agency implementing an "at least as effective as" variant of this BMP?	No
---	----

a. If YES, please explain in detail how your implementation of this BMP differs from Exhibit 1 and why you consider it to be "at least as effective as."

### D. Comments

Fire services are metered; hydrants are not.

## BMP 05: Large Landscape Conservation Programs and Incentives

Reporting Unit: <b>Los Angeles Dept. of Water and Power</b>	BMP Form Status: <b>100% Complete</b>	Year: <b>2007</b>
--	--	----------------------

### A. Water Use Budgets

1. Number of Dedicated Irrigation Meter Accounts:	745
2. Number of Dedicated Irrigation Meter Accounts with Water Budgets:	258
3. Budgeted Use for Irrigation Meter Accounts with Water Budgets (AF):	0
4. Actual Use for Irrigation Meter Accounts with Water Budgets (AF):	0
5. Does your agency provide water use notices to accounts with budgets each billing cycle?	yes

### B. Landscape Surveys

1. Has your agency developed a marketing / targeting strategy for landscape surveys?	yes
a. If YES, when did your agency begin implementing this strategy?	6/10/1996
b. Description of marketing / targeting strategy:	
Work with LA Dept Rec & Parks, school district to audit and provide audit training. All accts applying for landscape incentives also audited. Review consumption history for excess use.	
2. Number of Surveys Offered.	15
3. Number of Surveys Completed.	11
4. Indicate which of the following Landscape Elements are part of your survey:	
a. Irrigation System Check	yes
b. Distribution Uniformity Analysis	yes
c. Review / Develop Irrigation Schedules	yes
d. Measure Landscape Area	yes
e. Measure Total Irrigable Area	yes
f. Provide Customer Report / Information	yes

- 5. Do you track survey offers and results? yes
- 6. Does your agency provide follow-up surveys for previously completed surveys? yes
  - a. If YES, describe below:

Accounts with poor distribution uniformity re-audited after system improvements completed

**C. Other BMP 5 Actions**

- 1. An agency can provide mixed-use accounts with ETo-based landscape budgets in lieu of a large landscape survey program. no  
Does your agency provide mixed-use accounts with landscape budgets?
- 2. Number of CII mixed-use accounts with landscape budgets. 0
- 3. Do you offer landscape irrigation training? yes
- 4. Does your agency offer financial incentives to improve landscape water use efficiency? yes

Type of Financial Incentive:	Budget (Dollars/Year)	Number Awarded to Customers	Total Amount Awarded
a. Rebates	100000	0	0
b. Loans	0	0	0
c. Grants	80000	0	0

- 5. Do you provide landscape water use efficiency information to new customers and customers changing services? No
  - a. If YES, describe below:
- 6. Do you have irrigated landscaping at your facilities? yes
  - a. If yes, is it water-efficient? yes
  - b. If yes, does it have dedicated irrigation metering? yes
- 7. Do you provide customer notices at the start of the irrigation season? no
- 8. Do you provide customer notices at the end of the irrigation season? no

**D. "At Least As Effective As"**

- 1. Is your AGENCY implementing an "at least as effective as" variant of this BMP? Yes
  - a. If YES, please explain in detail how your implementation of this BMP differs from Exhibit 1 and why you consider it to be "at least as effective as."

The Los Angeles Department of Water and Power (LADWP) is taking a multi-pronged approach and implementing several programs to target our large landscapes (e.g. parks and schools) and commercial, industrial, and institutional (CII) customers having irrigated landscapes. LADWP implements the ambitious Technical Assistance Program (TAP), which is a custom financial incentive program offering CII and Multi-Family Residential customers in Los Angeles up to \$250,000 for the installation of pre-approved equipment and products (including the design and installation of efficient irrigation systems) that demonstrate persistent water savings. LADWP staff is currently working with a major customer on significant modifications for a new proprietary process that will conserve a considerable amount of water annually. LADWP has entered into a Memorandum of Understanding (MOU) with the Los Angeles

Department of Recreation and Parks (RAP) for the purpose of funding water use efficiency improvements for large landscapes in City parks. These water conservation improvements that LADWP and RAP are working in partnership to advance include installation of weather-based irrigation controllers, high efficiency sprinkler heads, and repair or replacement of irrigation distribution systems. The MOU strengthens LADWP's commitment to conservation as a means of providing a sustainable source of water to the City of Los Angeles as adopted by the Board in the 2005 Urban Water Management Plan. In August of 2008, LADWP amended its Emergency Water Conservation Plan (a City Ordinance) to address the increasing water shortage. The Plan's requirements are applicable to all LADWP customers, and are focused primarily on landscape irrigation. The Plan permits customers to use water only during specified hours of the day and specified days of the week, depending on the declared severity of water shortage. Water allotment varies by each phase (I-VI), such that phase I has the least amount of restrictions and phase VI having the most stringent restrictions. LADWP is currently developing a proposal for "Shortage Year" Water Rates (Tier 1 and Tier 2) for both commercial and residential customers that will become effective in mid-2009. Customers will be required to conserve 15% below their Tier 1 allotment to avoid a bill increase; however, those who exceed their allotment must pay Tier 2 rates resulting in higher water bills. Shortage Year Water Rates are designed to ensure that costs are recovered without penalizing customers who conserve during the years when projected demand for water exceeds the available supply. As has been demonstrated by LADWP's 100% volumetric rate structure, price signal is a most effective conservation tool. In addition to the Ordinance modifications described above, LADWP has developed and is planning to launch a Turf Buy Back Program in 2009. This new program will pay single family residential and commercial customers \$1.00 per square foot of turf removed and replaced with drought tolerant plants, mulch or permeable hardscape. Any subsequent irrigation requirements will be met with low volume drip or microspray emitters. LADWP is also in the process of expanding our recycled water program and are working with water intensive CII customers such as golf courses, parks, and refineries to promote and use recycled water. LADWP is currently converting all of our golf courses and parks to dedicated irrigation meters for the usage of recycled water. Our recycled water goal is to deliver at least 50,000 acre-feet per year by 2019. This will be done by expanding the "purple pipe" distribution system to new customers who can use recycled water for non-potable uses such as irrigation and industrial processes.

#### E. Comments

Reported as of 6/10/10

### BMP 06: High-Efficiency Washing Machine Rebate Programs

Reporting Unit:	BMP Form Status:	Year:
<b>Los Angeles Dept. of Water and Power</b>	<b>100% Complete</b>	<b>2007</b>

#### A. Implementation

1. Do any energy service providers or waste water utilities in your service area offer rebates for high-efficiency washers?
  - a. If YES, describe the offerings and incentives as well as who the

energy/waste water utility provider is.

- 2. Does your agency offer rebates for high-efficiency washers? yes
- 3. What is the level of the rebate?
- 4. Number of rebates awarded.

**B. Rebate Program Expenditures**

**This Year Next Year**

- 1. Budgeted Expenditures
- 2. Actual Expenditures

**C. "At Least As Effective As"**

- 1. Is your AGENCY implementing an "at least as effective as" variant of this BMP? no
  - a. If YES, please explain in detail how your implementation of this BMP differs from Exhibit 1 and why you consider it to be "at least as effective as."

**D. Comments**

Reported as of 6/10/10

**BMP 07: Public Information Programs**

Reporting Unit: **Los Angeles Dept. of Water and Power**      BMP Form Status: **100% Complete**      Year: **2007**

**A. Implementation**

- 1. How is your public information program implemented?
  - Wholesaler and retailer both materially participate in program
  - Which wholesaler(s)?
    - Metropolitan Water District of Southern California
- 2. Describe the program and how it's organized:
  - LADWP's Public Affairs Division works closely with the Water Conservation office. Information is made available on LADWP Web site, conservation publications distributed at public venues and by request (in English and Spanish); customer newsletter; Speakers Bureau and school presentations; fleet vehicle signage; posters and brochures in LADWP Customer Service Centers and City Council field offices; permanent water display located at Olvera Street, a popular Los Angeles landmark and tourist venue; a special flier regarding conservation was produced and inserted for distribution in the Los Angeles Times and Daily News in English and in Impacto in Spanish. Print advertisements were placed twice monthly beginning in November of 2005 and terminating December 2006 in various languages in the community press and major daily newspapers serving Los Angeles to Promote awareness of and participation in LADWP's residential water conservation programs. The LADWP Public Affairs Division prepares an outreach program annually based on the specific program needs of the Water Conservation office. Public Affairs implements the elements of the program which include development and production of collateral materials and exhibits; development and placement of all advertisements and public service announcements; development and posting of Web site announcements. MWDSC independently promotes conservation through various media channels and directly promotes programs via the bewaterwise.com website as well as by its program

implementation contractor.

3. Indicate which and how many of the following activities are included in your public information program:

Public Information Program Activity in Retail Service Area	Yes/No	Number of Events
a. Paid Advertising	yes	81
b. Public Service Announcement	no	
c. Bill Inserts / Newsletters / Brochures	yes	21
d. Bill showing water usage in comparison to previous year's usage	yes	
e. Demonstration Gardens	no	
f. Special Events, Media Events	yes	3
g. Speaker's Bureau	yes	5
h. Program to coordinate with other government agencies, industry and public interest groups and media	yes	

**B. Conservation Information Program Expenditures**

1. Annual Expenditures (Excluding Staffing)

**C. "At Least As Effective As"**

1. Is your AGENCY implementing an "at least as effective as" variant of this BMP? No

a. If YES, please explain in detail how your implementation of this BMP differs from Exhibit 1 and why you consider it to be "at least as effective as."

**D. Comments**

Reported as of 6/10/10

**BMP 08: School Education Programs**

Reporting Unit:

**Los Angeles Dept. of Water and Power**

BMP Form Status:  
**100% Complete**

Year:  
**2007**

**A. Implementation**

1. How is your public information program implemented?

Retailer runs program without wholesaler sponsorship

2. Please provide information on your region-wide school programs (by grade level):

Grade	Are grade-appropriate materials distributed?	No. of class presentations	No. of students reached	No. of teachers' workshops
Grades K-3rd	yes	2	490	13
Grades 4th-6th	yes	2	4325	13
Grades 7th-8th	yes	0	37800	13
High School	yes	0	56800	13



- 4. Did your Agency's materials meet state education framework requirements? yes
- 5. When did your Agency begin implementing this program? 09/15/1975

**B. School Education Program Expenditures**

- 1. Annual Expenditures (Excluding Staffing)

**C. "At Least As Effective As"**

- 1. Is your AGENCY implementing an "at least as effective as" variant of this BMP? No
  - a. If YES, please explain in detail how your implementation of this BMP differs from Exhibit 1 and why you consider it to be "at least as effective as."

**D. Comments**

Teachers' guide and supporting materials funded and/or provided by LADWP. Dedicated LADWP staff coordinate with school district throughout the school year.

Reported as of 6/10/10

**BMP 09: Conservation Programs for CII Accounts**

Reporting Unit: **Los Angeles Dept. of Water and Power**      BMP Form Status: **100% Complete**      Year: **2007**

**A. Implementation**

- 1. Has your agency identified and ranked COMMERCIAL customers according to use? yes
- 2. Has your agency identified and ranked INDUSTRIAL customers according to use? yes
- 3. Has your agency identified and ranked INSTITUTIONAL customers according to use? yes

**Option A: CII Water Use Survey and Customer Incentives Program**

- 4. Is your agency operating a CII water use survey and customer incentives program for the purpose of complying with BMP 9 under this option? If so, please describe activity during reporting period: yes

CII Surveys	Commercial Accounts	Industrial Accounts	Institutional Accounts
a. Number of New Surveys Offered	25	10	4
b. Number of New Surveys Completed	25	10	4
c. Number of Site Follow-ups of Previous Surveys (within 1 yr)	10	6	1
d. Number of Phone Follow-ups of Previous Surveys (within 1 yr)	10	3	1
<b>CII Survey Components</b>	<b>Commercial</b>	<b>Industrial</b>	<b>Institutional</b>

	Accounts	Accounts	Accounts
e. Site Visit	yes	yes	yes
f. Evaluation of all water-using apparatus and processes	yes	yes	yes
g. Customer report identifying recommended efficiency measures, paybacks and agency incentives	yes	yes	yes
Agency CII Customer Incentives	Budget (\$/Year)	# Awarded to Customers	Total \$ Amount Awarded
h. Rebates	150000	6980	737808
i. Loans	0	0	0
j. Grants	350000	0	0
k. Others	0	0	0

**Option B: CII Conservation Program Targets**

5. Does your agency track CII program interventions and water savings for the purpose of complying with BMP 9 under this option? yes

6. Does your agency document and maintain records on how savings were realized and the method of calculation for estimated savings? yes

7. **System Calculated** annual savings (AF/yr):

CII Programs	# Device Installations
a. Ultra Low Flush Toilets	4469
b. Dual Flush Toilets	1
c. High Efficiency Toilets	1404
d. High Efficiency Urinals	0
e. Non-Water Urinals	0
f. Commercial Clothes Washers (coin-op only; not industrial)	1037
g. Cooling Tower Controllers	23
h. Food Steamers	0
i. Ice Machines	0
j. Pre-Rinse Spray Valves	0
k. Steam Sterilizer Retrofits	0
l. X-ray Film Processors	0

8. **Estimated** annual savings (AF/yr) from agency programs not including the devices listed in Option B. 7., above:

CII Programs	Annual Savings (AF/yr)
a. Site-verified actions taken by agency:	0
b. Non-site-verified actions taken by agency:	0

**B. Conservation Program Expenditures for CII Accounts**

**This Year      Next Year**

1. Budgeted Expenditures	2750000	2750000
2. Actual Expenditures	737808	

**C. "At Least As Effective As"**

- 1. Is your agency implementing an "at least as effective as" variant of this BMP? No
  - a. If YES, please explain in detail how your implementation of this BMP differs from Exhibit 1 and why you consider it to be "at least as effective as."

**D. Comments**

**BMP 11: Conservation Pricing**

Reporting Unit: **Los Angeles Dept. of Water and Power**      BMP Form Status: **100% Complete**      Year: **2007**

**A. Implementation**

**Water Service Rate Structure Data by Customer Class**

**1. Single Family Residential**

- a. Rate Structure Increasing Block Seasonal
- b. Total Revenue from Commodity Charges (Volumetric Rates) \$ 274,814,458
- c. Total Revenue from Customer Meter/Service (Fixed) Charges \$ ,

**2. Multi-Family Residential**

- a. Rate Structure Increasing Block Seasonal
- b. Total Revenue from Commodity Charges (Volumetric Rates) \$ 188,638,894
- c. Total Revenue from Customer Meter/Service (Fixed) Charges \$ 0

**3. Commercial**

- a. Rate Structure Increasing Block Seasonal
- b. Total Revenue from Commodity Charges (Volumetric Rates) \$ 119,179,953
- c. Total Revenue from Customer Meter/Service (Fixed) Charges \$ 0

**4. Industrial**

- a. Rate Structure Increasing Block Seasonal
- b. Total Revenue from Commodity Charges (Volumetric Rates) \$ 23,200,289
- c. Total Revenue from Customer Meter/Service (Fixed) Charges \$ 0

**5. Institutional / Government**

- a. Rate Structure Increasing Block Seasonal
- b. Total Revenue from Commodity Charges (Volumetric Rates) \$ 32,620,283
- c. Total Revenue from Customer Meter/Service (Fixed) Charges \$ 0

**6. Dedicated Irrigation (potable)**

a. Rate Structure	Increasing Block Seasonal
b. Total Revenue from Commodity Charges (Volumetric Rates)	\$ 7,587,195
c. Total Revenue from Customer Meter/Service (Fixed) Charges	\$ 0

**7. Recycled-Reclaimed**

a. Rate Structure	Uniform
b. Total Revenue from Commodity Charges (Volumetric Rates)	\$ 2,665,729
c. Total Revenue from Customer Meter/Service (Fixed) Charges	\$ 0

**8. Raw**

a. Rate Structure	Service Not Provided
b. Total Revenue from Commodity Charges (Volumetric Rates)	\$ 0
c. Total Revenue from Customer Meter/Service (Fixed) Charges	\$ 0

**9. Other**

a. Rate Structure	Service Not Provided
b. Total Revenue from Commodity Charges (Volumetric Rates)	\$ 0
c. Total Revenue from Customer Meter/Service (Fixed) Charges	\$ 0

**B. Implementation Options**

**Select Either Option 1 or Option 2:**

**1. Option 1: Use Annual Revenue As Reported**

$V/(V+M) \geq 70\%$

V = Total annual revenue from volumetric rates  
 M = Total annual revenue from customer meter/service (fixed) charges

Selected

**2. Option 2: Use Canadian Water & Wastewater Association Rate Design Model**

$V/(V+M) \geq V'/(V'+M')$

V = Total annual revenue from volumetric rates  
 M = Total annual revenue from customer meter/service (fixed) charges

V' = The uniform volume rate based on the signatory's long-run incremental cost of service  
 M' = The associated meter charge

- a. If you selected Option 2, has your agency submitted to the Council a completed Canadian Water & Wastewater Association rate design model?
- b. Value for **V'** (uniform volume rate based on agency's long-run incremental cost of service) as determined by the Canadian Water & Wastewater Association rate design model:
- c. Value for **M'** (meter charge associated with V' uniform volume rate) as determined by the Canadian Water & Wastewater Association rate design model:

**C. Retail Wastewater (Sewer) Rate Structure Data by Customer Class**

1. Does your agency provide sewer service? (If YES, answer questions 2 - 7 below, else continue to section D.) No

**2. Single Family Residential**

- a. Sewer Rate Structure
- b. Total Annual Revenue \$ 0
- c. Total Revenue from Commodity Charges (Volumetric Rates) \$ 0

**3. Multi-Family Residential**

- a. Sewer Rate Structure
- b. Total Annual Revenue \$ 0
- c. Total Revenue from Commodity Charges (Volumetric Rates) \$ 0

**4. Commercial**

- a. Sewer Rate Structure
- b. Total Annual Revenue \$ 0
- c. Total Revenue from Commodity Charges (Volumetric Rates) \$ 0

**5. Industrial**

- a. Sewer Rate Structure
- b. Total Annual Revenue \$ 0
- c. Total Revenue from Commodity Charges (Volumetric Rates) \$ 0

**6. Institutional / Government**

- a. Sewer Rate Structure
- b. Total Annual Revenue \$ 0
- c. Total Revenue from Commodity Charges (Volumetric Rates) \$ 0

**7. Recycled-reclaimed water**

- a. Sewer Rate Structure
- b. Total Annual Revenue \$ 0
- c. Total Revenue from Commodity Charges (Volumetric Rates) \$ 0

**D. "At Least As Effective As"**

1. Is your agency implementing an "at least as effective as" variant of this BMP? No

a. If YES, please explain in detail how your implementation of this BMP differs from Exhibit 1 and why you consider it to be "at least as effective as."

**E. Comments**

Link to LADWP Water Rate Ordinance:  
<http://www.ladwp.com/ladwp/cms/ladwp001149.pdf>

**BMP 12: Conservation Coordinator**

Reporting Unit: **Los Angeles Dept. of Water and Power**      BMP Form Status: **100% Complete**      Year: **2007**

**A. Implementation**

1. Does your Agency have a conservation coordinator? yes
2. Is a coordinator position supplied by another agency with which you cooperate in a regional conservation program ? no
  - a. Partner agency's name:
3. If your agency supplies the conservation coordinator:
  - a. What percent is this conservation coordinator's position? 100%
  - b. Coordinator's Name Thomas Gackstetter
  - c. Coordinator's Title Water Conservation Manager
  - d. Coordinator's Experience and Number of Years 20
  - e. Date Coordinator's position was created (mm/dd/yyyy) 12/11/1991
4. Number of conservation staff (FTEs), including Conservation Coordinator. 5

**B. Conservation Staff Program Expenditures**

1. Staffing Expenditures (In-house Only) 597610
2. BMP Program Implementation Expenditures 5989000

**C. "At Least As Effective As"**

1. Is your AGENCY implementing an "at least as effective as" variant of this BMP? no
  - a. If YES, please explain in detail how your implementation of this BMP differs from Exhibit 1 and why you consider it to be "at least as effective as."

**D. Comments****BMP 13: Water Waste Prohibition**

Reporting Unit: **Los Angeles Dept. of Water and Power**      BMP Form Status: **100% Complete**      Year: **2007**

**A. Requirements for Documenting BMP Implementation**

1. Is a water waste prohibition ordinance in effect in your service area? yes
  - a. If YES, describe the ordinance:
 

Prohibits use of water on hardscape, gutter flooding, unattended leaks, mid-day watering, serving water in restaurants w/o request, non recirc fountains
2. Is a copy of the most current ordinance(s) on file with CUWCC? yes
  - a. List local jurisdictions in your service area in the first text box and water waste ordinance citations in each jurisdiction in the second text

box:

City of Los Angeles

Ord No. 166080

**B. Implementation**

1. Indicate which of the water uses listed below are prohibited by your agency or service area.

- a. Gutter flooding yes
- b. Single-pass cooling systems for new connections Yes
- c. Non-recirculating systems in all new conveyor or car wash systems Yes
- d. Non-recirculating systems in all new commercial laundry systems Yes
- e. Non-recirculating systems in all new decorative fountains yes
- f. Other, please name yes  
See above

2. Describe measures that prohibit water uses listed above:

Specific ordinance language, monetary penalties, service restrictions/shutoff. Cost of water/wastewater and common practice limits number of single pass systems

**Water Softeners:**

3. Indicate which of the following measures your agency has supported in developing state law:

- a. Allow the sale of more efficient, demand-initiated regenerating DIR models. no
- b. Develop minimum appliance efficiency standards that:
  - i.) Increase the regeneration efficiency standard to at least 3,350 grains of hardness removed per pound of common salt used. no
  - ii.) Implement an identified maximum number of gallons discharged per gallon of soft water produced. no
- c. Allow local agencies, including municipalities and special districts, to set more stringent standards and/or to ban on-site regeneration of water softeners if it is demonstrated and found by the agency governing board that there is an adverse effect on the reclaimed water or groundwater supply. no

4. Does your agency include water softener checks in home water audit programs? no

5. Does your agency include information about DIR and exchange-type water softeners in educational efforts to encourage replacement of less efficient timer models? no

**C. "At Least As Effective As"**

1. Is your AGENCY implementing an "at least as effective as" variant of this BMP? no

a. If YES, please explain in detail how your implementation of this BMP differs from Exhibit 1 and why you consider it to be "at least as effective as."

**D. Comments**

**BMP 14: Residential ULFT Replacement Programs**

Reporting Unit: **Los Angeles Dept. of Water and Power**      BMP Form Status: **100% Complete**      Year: **2007**

### A. Implementation

#### Number of 1.6 gpf Toilets Replaced by Agency Program During Report Year

	Single-Family Accounts	Multi-Family Units
1. Does your Agency have program(s) for replacing high-water-using toilets with ultra-low flush toilets?	yes	yes
<b>Replacement Method</b>	<b>SF Accounts</b>	<b>MF Units</b>
2. Rebate	2043	386
3. Direct Install	5448	9912
4. CBO Distribution	126	92
5. Other	0	0
<b>Total</b>	<b>7617</b>	<b>10390</b>

#### Number of 1.2 gpf High-Efficiency Toilets (HETs) Replaced by Agency Program During Report Year

	Single-Family Accounts	Multi-Family Units
6. Does your Agency have program(s) for replacing high-water-using toilets with ultra-low flush toilets?	no	no
<b>Replacement Method</b>	<b>SF Accounts</b>	<b>MF Units</b>
7. Rebate		
8. Direct Install		
9. CBO Distribution		
10. Other		
<b>Total</b>		

#### Number of Dual-Flush Toilets Replaced by Agency Program During Report Year

	Single-Family Accounts	Multi-Family Units
11. Does your Agency have program(s) for replacing high-water-using toilets with ultra-low flush toilets?	no	no
<b>Replacement Method</b>	<b>SF Accounts</b>	<b>MF Units</b>
12. Rebate	0	0
13. Direct Install	0	0
14. CBO Distribution	0	0
15. Other	0	0
<b>Total</b>	<b>0</b>	<b>0</b>

16. Describe your agency's ULFT, HET, and/or Dual-Flush Toilet programs for



single-family residences.

Rebate of \$100 per toilet replaced or free toilet in exchange for old toilet (installed free on request). Rebate paid on ULFT, HET and Dual Flush.

17. Describe your agency's ULFT, HET, and/or Dual-Flush Toilet programs for multi-family residences.

Rebate of \$75 per toilet replaced or free toilet in exchange for old toilet (installed free on request). Rebate paid on ULFT, HET and Dual Flush.

18. Is a toilet retrofit on resale ordinance in effect for your service area? yes

19. List local jurisdictions in your service area in the left box and ordinance citations in each jurisdiction in the right box:

City of Los Angeles

Ord. No. 172075

### **B. Residential ULFT Program Expenditures**

1. Estimated cost per ULFT/HET replacement: 242.86

### **C. "At Least As Effective As"**

1. Is your AGENCY implementing an "at least as effective as" variant of this BMP? no

a. If YES, please explain in detail how your implementation of this BMP differs from Exhibit 1 and why you consider it to be "at least as effective as."

### **D. Comments**

Cost per unit includes all programmatic costs.

# **2008 CUWCC Biennial Report**

**Water Supply & Reuse**

Reporting Unit:  
**Los Angeles Dept. of Water and Power**

Year:  
**2008**

**Water Supply Source Information**

<b>Supply Source Name</b>	<b>Quantity (AF) Supplied</b>	<b>Supply Type</b>
LA Aqueduct	152642	Imported
MWDSC	421732	Imported
Groundwater	71023	Groundwater
Recycled	4273	Recycled
Transfer	1241	Imported
Storage	198	Imported

**Total AF: 651109**

Reported as of 6/10/10

**Accounts & Water Use**

Reporting Unit Name: **Los Angeles Dept. of Water and Power** Submitted to CUWCC **02/08/2009** Year: **2008**

What is the reporting year? Fiscal Month Ending June

**A. Service Area Population Information:**

1. Total service area population 4071873

**B. Number of Accounts and Water Deliveries (AF)**

Type	Metered		Unmetered	
	No. of Accounts	Water Deliveries (AF)	No. of Accounts	Water Deliveries (AF)
1. Single-Family	482675	249530	0	0
2. Multi-Family	124403	183064	0	0
3. Commercial	72403	109091	0	0
4. Industrial	6830	24257	0	0
5. Institutional	7583	44803	0	0
6. Dedicated Irrigation	766	264	0	0
7. Recycled Water	45	4130	0	0
8. Other	0	0	0	0
9. Unaccounted	NA	37223	NA	0
<b>Total</b>	694705	652362	0	0

Metered Unmetered

Reported as of 6/10/10

**BMP 01: Water Survey Programs for Single-Family and Multi-Family Residential Customers**

Reporting Unit: **Los Angeles Dept. of Water and Power** BMP Form Status: **100% Complete** Year: **2008**

**A. Implementation**

- 1. Based on your signed MOU date, 09/12/1991, your Agency STRATEGY DUE DATE is: 09/11/1993
- 2. Has your agency developed and implemented a targeting/marketing strategy for SINGLE-FAMILY residential water use surveys? yes
  - a. If YES, when was it implemented? 06/01/1990
- 3. Has your agency developed and implemented a targeting/marketing strategy for MULTI-FAMILY residential water use surveys? yes
  - a. If YES, when was it implemented? 06/01/1990

**B. Water Survey Data**

Single

<b>Survey Counts:</b>	<b>Family Accounts</b>	<b>Multi-Family Units</b>
1. Number of surveys offered:	0	0
2. Number of surveys completed:	0	0

**Indoor Survey:**

3. Check for leaks, including toilets, faucets and meter checks	yes	yes
4. Check showerhead flow rates, aerator flow rates, and offer to replace or recommend replacement, if necessary	yes	yes
5. Check toilet flow rates and offer to install or recommend installation of displacement device or direct customer to ULFT replacement program, as necessary; replace leaking toilet flapper, as necessary	yes	yes

**Outdoor Survey:**

6. Check irrigation system and timers	no	no
7. Review or develop customer irrigation schedule	no	no
8. Measure landscaped area (Recommended but not required for surveys)	no	no
9. Measure total irrigable area (Recommended but not required for surveys)	no	no
10. Which measurement method is typically used (Recommended but not required for surveys)		None
11. Were customers provided with information packets that included evaluation results and water savings recommendations?	no	no
12. Have the number of surveys offered and completed, survey results, and survey costs been tracked?	yes	no
a. If yes, in what form are surveys tracked?		manual activity
b. Describe how your agency tracks this information.		

In-house filing system

**C. "At Least As Effective As"**

1. Is your AGENCY implementing an "at least as effective as" variant of this BMP?	No
a. If YES, please explain in detail how your implementation of this BMP differs from Exhibit 1 and why you consider it to be "at least as effective as."	

**D. Comments**

Period: FY 07-08 ULFT Rebate and D.I. programs end on 12/31/06.  
Marketing stops.

Reported as of 6/10/10

**BMP 02: Residential Plumbing Retrofit**

Reporting Unit:

**Los Angeles Dept. of Water and**    BMP Form Status:    Year:

**Power** **100% Complete** **2008**  
**A. Implementation**

1. Is there an enforceable ordinance in effect in your service area requiring replacement of high-flow showerheads and other water use fixtures with their low-flow counterparts? yes

a. If YES, list local jurisdictions in your service area and code or ordinance in each:

City of Los Angeles "Water Closet, Urinal and Showerhead Regulations-Retrofit on Resale" Ordinance (No. 172075)

2. Has your agency satisfied the 75% saturation requirement for single-family housing units? yes

3. Estimated percent of single-family households with low-flow showerheads: 99%

4. Has your agency satisfied the 75% saturation requirement for multi-family housing units? yes

5. Estimated percent of multi-family households with low-flow showerheads: 99%

6. If YES to 2 OR 4 above, please describe how saturation was determined, including the dates and results of any survey research.

LA enacted an ordinance requiring all LADWP customers to install low flow showerheads & have installations certified or incur financial penalties for non-compliance. 99+% of LADWP customers have demonstrated compliance

**B. Low-Flow Device Distribution Information**

1. Has your agency developed a targeting/ marketing strategy for distributing low-flow devices? yes

a. If YES, when did your agency begin implementing this strategy? 07/01/1988

b. Describe your targeting/ marketing strategy.

Direct mail to all SF customers; element of all survey pgms; req'd per L.A. ordinance; provided upon request to any residential customer; distributed with program ULFTs.

Low-Flow Devices Distributed/ Installed	SF Accounts	MF Units
2. Number of low-flow showerheads distributed:	3812	12896
3. Number of toilet-displacement devices distributed:	2	0
4. Number of toilet flappers distributed:	39	11
5. Number of faucet aerators distributed:	57	2300
6. Does your agency track the distribution and cost of low-flow devices?		yes

a. If YES, in what format are low-flow devices tracked? Database

b. If yes, describe your tracking and distribution system :

Tracking: in-house inventory control; Distribution through Water Conservation office to customers who call in and through LADWP account executives.

**C. "At Least As Effective As"**

1. Is your AGENCY implementing an "at least as effective as" variant of this BMP? No

a. If YES, please explain in detail how your implementation of this BMP

differs from Exhibit 1 and why you consider it to be "at least as effective as."

**D. Comments**

Reported as of 6/10/10

**BMP 03: System Water Audits, Leak Detection and Repair**

Reporting Unit: **Los Angeles Dept. of Water and Power**      BMP Form Status: **100% Complete**      Year: **2008**

**A. Implementation**

- 1. Does your agency own or operate a water distribution system? yes
- 2. Has your agency completed a pre-screening system audit for this reporting year? Yes
- 3. If YES, enter the values (AF/Year) used to calculate verifiable use as a percent of total production:
  - a. Determine metered sales (AF) 611008
  - b. Determine other system verifiable uses (AF) 0
  - c. Determine total supply into the system (AF) 648231
  - d. Using the numbers above, if (Metered Sales + Other Verifiable Uses) / Total Supply is < 0.9 then a full-scale system audit is required. 0.94
- 4. Does your agency keep necessary data on file to verify the values entered in question 3? yes
- 5. Did your agency complete a full-scale audit during this report year? no
- 6. Does your agency maintain in-house records of audit results or completed AWWA M36 audit worksheets for the completed audit which could be forwarded to CUWCC? yes
- 7. Does your agency operate a system leak detection program? no
  - a. If yes, describe the leak detection program:

**B. Survey Data**

- 1. Total number of miles of distribution system line. 7228
- 2. Number of miles of distribution system line surveyed. 0

**C. "At Least As Effective As"**

- 1. Is your AGENCY implementing an "at least as effective as" variant of this BMP? No
  - a. If YES, please explain in detail how your implementation of this BMP differs from Exhibit 1 and why you consider it to be "at least as effective as."

**D. Comments**

**Voluntary Questions (Not used to calculate compliance)**

---

**E. Volumes**

- |   | <b>Estimated</b> | <b>Verified</b> |
|---|------------------|-----------------|
| 1. Volume of raw water supplied to the system:      |                  |                 |
| 2. Volume treated water supplied into the system:   |                  |                 |
| 3. Volume of water exported from the system:        |                  |                 |
| 4. Volume of billed authorized metered consumption: |                  |                 |



5. Volume of billed authorized unmetered consumption:
6. Volume of unbilled authorized metered consumption:
7. Volume of unbilled authorized unmetered consumption:

## F. Infrastructure and Hydraulics

1. System input (source or master meter) volumes metered at the entry to the:
2. How frequently are they tested and calibrated?
3. Length of mains:
4. What % of distribution mains are rigid pipes (metal, ac, concrete)?
5. Number of service connections:
6. What % of service connections are rigid pipes (metal)?
7. Are residential properties fully metered?
8. Are non-residential properties fully metered?
9. Provide an estimate of customer meter under-registration:
10. Average length of customer service line from the main to the point of the meter:
11. Average system pressure:
12. Range of system pressures: From to
13. What percentage of the system is fed from gravity feed?
14. What percentage of the system is fed by pumping and re-pumping?

## G. Maintenance Questions

1. Who is responsible for providing, testing, repairing and replacing customer meters?
2. Does your agency test, repair and replace your meters on a regular timed schedule?
  - a. If yes, does your agency test by meter size or customer category?:
    - Less than or equal to 1"
    - 1.5" to 2"
    - 3" and Larger
  - b. If yes to meter size, please provide the frequency of testing by meter size:
  - c. If yes to customer category, provide the frequency of testing by customer category:
    - SF residential
    - MF residential
    - Commercial
    - Industrial & Institutional
3. Who is responsible for repairs to the customer lateral or customer service line?
4. Who is responsible for service line repairs downstream of the customer meter?
5. Does your agency proactively search for leaks using leak

survey techniques or does your utility reactively repair leaks which are called in, or both?

6. What is the utility budget breakdown for:

Leak Detection	\$
Leak Repair	\$
Auditing and Water Loss Evaluation	\$
Meter Testing	\$

**H. Comments**

Reported as of 6/10/10

**BMP 04: Metering with Commodity Rates for all New Connections and Retrofit of Existing**

Reporting Unit: **Los Angeles Dept. of Water and Power**      BMP Form Status: **100% Complete**      Year: **2008**

**A. Implementation**

- 1. Does your agency have any unmetered service connections? No
  - a. If YES, has your agency completed a meter retrofit plan?
  - b. If YES, number of previously unmetered accounts fitted with meters during report year:
- 2. Are all new service connections being metered and billed by volume of use? Yes
- 3. Are all new service connections being billed volumetrically with meters? Yes
- 4. Has your agency completed and submitted electronically to the Council a written plan, policy or program to test, repair and replace meters? Yes
- 5. Please fill out the following matrix:

Account Type	Number of Metered Accounts	Number of Metered Accounts Read	Number of Metered Accounts Billed by Volume	Billing Frequency Per Year	Number of Volume Estimates
a. Single Family	483433	483433	483433	6	0
b. Multi-Family	121693	121693	121693	6	0
c. Commercial	60327	60327	60327	12	0
d. Industrial	6552	6552	6552	12	0
e. Institutional	6707	6707	6707	12	0
f. Landscape Irrigation	766	766	766	12	0

**B. Feasibility Study**

- 1. Has your agency conducted a feasibility study to assess the merits of a program to provide incentives to switch mixed-use accounts to dedicated landscape meters? no
  - a. If YES, when was the feasibility study conducted? (mm/dd/yy)

b. Describe the feasibility study:

- 2. Number of CII accounts with mixed-use meters: 60327
- 3. Number of CII accounts with mixed-use meters retrofitted with dedicated irrigation meters during reporting period. 0

**C. "At Least As Effective As"**

- 1. Is your agency implementing an "at least as effective as" variant of this BMP? No

a. If YES, please explain in detail how your implementation of this BMP differs from Exhibit 1 and why you consider it to be "at least as effective as."

**D. Comments**

Fire services are metered; hydrants are not.

**BMP 05: Large Landscape Conservation Programs and Incentives**

Reporting Unit: **Los Angeles Dept. of Water and Power**      BMP Form Status: **100% Complete**      Year: **2008**

**A. Water Use Budgets**

- 1. Number of Dedicated Irrigation Meter Accounts: 766
- 2. Number of Dedicated Irrigation Meter Accounts with Water Budgets: 269
- 3. Budgeted Use for Irrigation Meter Accounts with Water Budgets (AF): 0
- 4. Actual Use for Irrigation Meter Accounts with Water Budgets (AF): 0
- 5. Does your agency provide water use notices to accounts with budgets each billing cycle? yes

**B. Landscape Surveys**

- 1. Has your agency developed a marketing / targeting strategy for landscape surveys? yes
  - a. If YES, when did your agency begin implementing this strategy? 6/10/1996
  - b. Description of marketing / targeting strategy:

Work with LA Dept Rec & Parks, school district to audit and provide audit training. All accts applying for landscape incentives also audited. Review consumption history for excess use.

- 2. Number of Surveys Offered. 6
- 3. Number of Surveys Completed. 6
- 4. Indicate which of the following Landscape Elements are part of your survey:
  - a. Irrigation System Check yes
  - b. Distribution Uniformity Analysis yes
  - c. Review / Develop Irrigation Schedules yes
  - d. Measure Landscape Area yes
  - e. Measure Total Irrigable Area yes
  - f. Provide Customer Report / Information yes

- 5. Do you track survey offers and results? yes
- 6. Does your agency provide follow-up surveys for previously completed surveys? yes

a. If YES, describe below:

Accounts with poor distribution uniformity re-audited after system improvements completed

**C. Other BMP 5 Actions**

- 1. An agency can provide mixed-use accounts with ETo-based landscape budgets in lieu of a large landscape survey program. no  
Does your agency provide mixed-use accounts with landscape budgets?
- 2. Number of CII mixed-use accounts with landscape budgets. 0
- 3. Do you offer landscape irrigation training? yes
- 4. Does your agency offer financial incentives to improve landscape water use efficiency? yes

Type of Financial Incentive:	Budget (Dollars/Year)	Number Awarded to Customers	Total Amount Awarded
a. Rebates	1000000	1	8538
b. Loans	0	0	0
c. Grants	80000	0	0

- 5. Do you provide landscape water use efficiency information to new customers and customers changing services? No

a. If YES, describe below:

- 6. Do you have irrigated landscaping at your facilities? yes
  - a. If yes, is it water-efficient? yes
  - b. If yes, does it have dedicated irrigation metering? yes
- 7. Do you provide customer notices at the start of the irrigation season? no
- 8. Do you provide customer notices at the end of the irrigation season? no

**D. "At Least As Effective As"**

- 1. Is your AGENCY implementing an "at least as effective as" variant of this BMP? Yes

a. If YES, please explain in detail how your implementation of this BMP differs from Exhibit 1 and why you consider it to be "at least as effective as."

The Los Angeles Department of Water and Power (LADWP) is taking a multi-pronged approach and implementing several programs to target our large landscapes (e.g. parks and schools) and commercial, industrial, and institutional (CII) customers having irrigated landscapes. LADWP implements the ambitious Technical Assistance Program (TAP), which is a custom financial incentive program offering CII and Multi-Family Residential customers in Los Angeles up to \$250,000 for the installation of pre-approved equipment and products (including the design and installation of efficient irrigation systems) that demonstrate persistent water savings. LADWP staff is currently working with a major customer on significant modifications for a new proprietary process that will conserve a considerable amount of water annually. LADWP has entered into a Memorandum of Understanding (MOU) with the Los Angeles

Department of Recreation and Parks (RAP) for the purpose of funding water use efficiency improvements for large landscapes in City parks. These water conservation improvements that LADWP and RAP are working in partnership to advance include installation of weather-based irrigation controllers, high efficiency sprinkler heads, and repair or replacement of irrigation distribution systems. The MOU strengthens LADWP's commitment to conservation as a means of providing a sustainable source of water to the City of Los Angeles as adopted by the Board in the 2005 Urban Water Management Plan. In August of 2008, LADWP amended its Emergency Water Conservation Plan (a City Ordinance) to address the increasing water shortage. The Plan's requirements are applicable to all LADWP customers, and are focused primarily on landscape irrigation. The Plan permits customers to use water only during specified hours of the day and specified days of the week, depending on the declared severity of water shortage. Water allotment varies by each phase (I-VI), such that phase I has the least amount of restrictions and phase VI having the most stringent restrictions. LADWP is currently developing a proposal for "Shortage Year" Water Rates (Tier 1 and Tier 2) for both commercial and residential customers that will become effective in mid-2009. Customers will be required to conserve 15% below their Tier 1 allotment to avoid a bill increase; however, those who exceed their allotment must pay Tier 2 rates resulting in higher water bills. Shortage Year Water Rates are designed to ensure that costs are recovered without penalizing customers who conserve during the years when projected demand for water exceeds the available supply. As has been demonstrated by LADWP's 100% volumetric rate structure, price signal is a most effective conservation tool. In addition to the Ordinance modifications described above, LADWP has developed and is planning to launch a Turf Buy Back Program in 2009. This new program will pay single family residential and commercial customers \$1.00 per square foot of turf removed and replaced with drought tolerant plants, mulch or permeable hardscape. Any subsequent irrigation requirements will be met with low volume drip or microspray emitters. LADWP is also in the process of expanding our recycled water program and are working with water intensive CII customers such as golf courses, parks, and refineries to promote and use recycled water. LADWP is currently converting all of our golf courses and parks to dedicated irrigation meters for the usage of recycled water. Our recycled water goal is to deliver at least 50,000 acre-feet per year by 2019. This will be done by expanding the "purple pipe" distribution system to new customers who can use recycled water for non-potable uses such as irrigation and industrial processes.

**E. Comments**

Reported as of 6/10/10

**BMP 06: High-Efficiency Washing Machine Rebate Programs**

Reporting Unit:	BMP Form Status:	Year:
<b>Los Angeles Dept. of Water and Power</b>	<b>100% Complete</b>	<b>2008</b>

**A. Implementation**

1. Do any energy service providers or waste water utilities in your service area offer rebates for high-efficiency washers?
  - a. If YES, describe the offerings and incentives as well as who the

energy/waste water utility provider is.

- 2. Does your agency offer rebates for high-efficiency washers? yes
- 3. What is the level of the rebate?
- 4. Number of rebates awarded.

**B. Rebate Program Expenditures**

**This Year Next Year**

- 1. Budgeted Expenditures
- 2. Actual Expenditures

**C. "At Least As Effective As"**

- 1. Is your AGENCY implementing an "at least as effective as" variant of this BMP? no
  - a. If YES, please explain in detail how your implementation of this BMP differs from Exhibit 1 and why you consider it to be "at least as effective as."

**D. Comments**

Reported as of 6/10/10

**BMP 07: Public Information Programs**

Reporting Unit: **Los Angeles Dept. of Water and Power**      BMP Form Status: **100% Complete**      Year: **2008**

**A. Implementation**

- 1. How is your public information program implemented?
  - Wholesaler and retailer both materially participate in program
  - Which wholesaler(s)?
    - Metropolitan Water District of Southern California
- 2. Describe the program and how it's organized:
  - LADWP's Public Affairs Division works closely with the Water Conservation office. Information is made available on LADWP Web site, conservation publications distributed at public venues and by request (in English and Spanish); customer newsletter; Speakers Bureau and school presentations; fleet vehicle signage; posters and brochures in LADWP Customer Service Centers and City Council field offices; permanent water display located at Olvera Street, a popular Los Angeles landmark and tourist venue; a special flier regarding conservation was produced and inserted for distribution in the Los Angeles Times and Daily News in English and in Impacto in Spanish. Print advertisements were placed twice monthly beginning in November of 2005 and terminating December 2006 in various languages in the community press and major daily newspapers serving Los Angeles to Promote awareness of and participation in LADWP's residential water conservation programs. The LADWP Public Affairs Division prepares an outreach program annually based on the specific program needs of the Water Conservation office. Public Affairs implements the elements of the program which include development and production of collateral materials and exhibits; development and placement of all advertisements and public service announcements; development and posting of Web site announcements. MWDSC independently promotes conservation through various media channels and directly promotes programs via the bewaterwise.com website as well as by its program

implementation contractor

3. Indicate which and how many of the following activities are included in your public information program:

Public Information Program Activity in Retail Service Area	Yes/No	Number of Events
a. Paid Advertising	yes	250
b. Public Service Announcement	no	
c. Bill Inserts / Newsletters / Brochures	yes	22
d. Bill showing water usage in comparison to previous year's usage	yes	
e. Demonstration Gardens	no	
f. Special Events, Media Events	yes	3
g. Speaker's Bureau	yes	10
h. Program to coordinate with other government agencies, industry and public interest groups and media	yes	

**B. Conservation Information Program Expenditures**

1. Annual Expenditures (Excluding Staffing)

**C. "At Least As Effective As"**

1. Is your AGENCY implementing an "at least as effective as" variant of this BMP? No

a. If YES, please explain in detail how your implementation of this BMP differs from Exhibit 1 and why you consider it to be "at least as effective as."

**D. Comments**

Reported as of 6/10/10

**BMP 08: School Education Programs**

Reporting Unit:

**Los Angeles Dept. of Water and Power**

BMP Form Status:  
**100% Complete**

Year:  
**2008**

**A. Implementation**

1. How is your public information program implemented?

Retailer runs program without wholesaler sponsorship

2. Please provide information on your region-wide school programs (by grade level):

Grade	Are grade-appropriate materials distributed?	No. of class presentations	No. of students reached	No. of teachers' workshops
Grades K-3rd	yes	0	0	0
Grades 4th-6th	yes	0	3600	0
Grades 7th-8th	yes	0	18500	0
High School	yes	0	29500	0

- 4. Did your Agency's materials meet state education framework requirements? yes
- 5. When did your Agency begin implementing this program? 09/15/1975

**B. School Education Program Expenditures**

- 1. Annual Expenditures (Excluding Staffing)

**C. "At Least As Effective As"**

- 1. Is your AGENCY implementing an "at least as effective as" variant of this BMP? No
  - a. If YES, please explain in detail how your implementation of this BMP differs from Exhibit 1 and why you consider it to be "at least as effective as."

**D. Comments**

Teachers' guide and supporting materials funded and/or provided by LADWP. Dedicated LADWP staff coordinate with school district throughout the school year.

Reported as of 6/10/10

**BMP 09: Conservation Programs for CII Accounts**

Reporting Unit: **Los Angeles Dept. of Water and Power**      BMP Form Status: **100% Complete**      Year: **2008**

**A. Implementation**

- 1. Has your agency identified and ranked COMMERCIAL customers according to use? yes
- 2. Has your agency identified and ranked INDUSTRIAL customers according to use? yes
- 3. Has your agency identified and ranked INSTITUTIONAL customers according to use? yes

**Option A: CII Water Use Survey and Customer Incentives Program**

- 4. Is your agency operating a CII water use survey and customer incentives program for the purpose of complying with BMP 9 under this option? If so, please describe activity during reporting period: yes

CII Surveys	Commercial Accounts	Industrial Accounts	Institutional Accounts
a. Number of New Surveys Offered	15	7	4
b. Number of New Surveys Completed	15	7	4
c. Number of Site Follow-ups of Previous Surveys (within 1 yr)	6	4	1
d. Number of Phone Follow-ups of Previous Surveys (within 1 yr)	6	2	1
<b>CII Survey Components</b>	<b>Commercial</b>	<b>Industrial</b>	<b>Institutional</b>



	Accounts	Accounts	Accounts
e. Site Visit	yes	yes	yes
f. Evaluation of all water-using apparatus and processes	yes	yes	yes
g. Customer report identifying recommended efficiency measures, paybacks and agency incentives	yes	yes	yes
Agency CII Customer Incentives	Budget (\$/Year)	# Awarded to Customers	Total \$ Amount Awarded
h. Rebates	1500000	6605	925931
i. Loans	0	0	0
j. Grants	350000	0	0
k. Others	0	0	0

**Option B: CII Conservation Program Targets**

5. Does your agency track CII program interventions and water savings for the purpose of complying with BMP 9 under this option? yes

6. Does your agency document and maintain records on how savings were realized and the method of calculation for estimated savings? yes

7. **System Calculated** annual savings (AF/yr):

CII Programs	# Device Installations
a. Ultra Low Flush Toilets	1127
b. Dual Flush Toilets	525
c. High Efficiency Toilets	1721
d. High Efficiency Urinals	1327
e. Non-Water Urinals	346
f. Commercial Clothes Washers (coin-op only; not industrial)	835
g. Cooling Tower Controllers	26
h. Food Steamers	13
i. Ice Machines	0
j. Pre-Rinse Spray Valves	2
k. Steam Sterilizer Retrofits	5
l. X-ray Film Processors	0

8. **Estimated** annual savings (AF/yr) from agency programs not including the devices listed in Option B. 7., above:

CII Programs	Annual Savings (AF/yr)
a. Site-verified actions taken by agency:	0
b. Non-site-verified actions taken by agency:	0

**B. Conservation Program Expenditures for CII Accounts**

This Year      Next Year

1. Budgeted Expenditures	2750000	2750000
2. Actual Expenditures	925931	

**C. "At Least As Effective As"**

1. Is your agency implementing an "at least as effective as" variant of this BMP? No
  - a. If YES, please explain in detail how your implementation of this BMP differs from Exhibit 1 and why you consider it to be "at least as effective as."

**D. Comments**

**BMP 11: Conservation Pricing**

Reporting Unit: **Los Angeles Dept. of Water and Power**      BMP Form Status: **100% Complete**      Year: **2008**

**A. Implementation**

**Water Service Rate Structure Data by Customer Class**

**1. Single Family Residential**

- |  |                           |
|--|---------------------------|
| a. Rate Structure  | Increasing Block Seasonal |
| b. Total Revenue from Commodity Charges (Volumetric Rates)   | \$ 299,536,198            |
| c. Total Revenue from Customer Meter/Service (Fixed) Charges | \$ ,                      |

**2. Multi-Family Residential**

- |  |                           |
|--|---------------------------|
| a. Rate Structure  | Increasing Block Seasonal |
| b. Total Revenue from Commodity Charges (Volumetric Rates)   | \$ 216,210,111            |
| c. Total Revenue from Customer Meter/Service (Fixed) Charges | \$ 0                      |

**3. Commercial**

- |  |                           |
|--|---------------------------|
| a. Rate Structure  | Increasing Block Seasonal |
| b. Total Revenue from Commodity Charges (Volumetric Rates)   | \$ 138,218,700            |
| c. Total Revenue from Customer Meter/Service (Fixed) Charges | \$ 0                      |

**4. Industrial**

- |  |                           |
|--|---------------------------|
| a. Rate Structure  | Increasing Block Seasonal |
| b. Total Revenue from Commodity Charges (Volumetric Rates)   | \$ 30,670,561             |
| c. Total Revenue from Customer Meter/Service (Fixed) Charges | \$ 0                      |

**5. Institutional / Government**

- |  |                           |
|--|---------------------------|
| a. Rate Structure  | Increasing Block Seasonal |
| b. Total Revenue from Commodity Charges (Volumetric Rates)   | \$ 36,762,959             |
| c. Total Revenue from Customer Meter/Service (Fixed) Charges | \$ 0                      |

<b>6. Dedicated Irrigation (potable)</b>	
a. Rate Structure	Increasing Block Seasonal
b. Total Revenue from Commodity Charges (Volumetric Rates)	\$ 7,965,994
c. Total Revenue from Customer Meter/Service (Fixed) Charges	\$ 0
<b>7. Recycled-Reclaimed</b>	
a. Rate Structure	Uniform
b. Total Revenue from Commodity Charges (Volumetric Rates)	\$ 1,679,516
c. Total Revenue from Customer Meter/Service (Fixed) Charges	\$ 0
<b>8. Raw</b>	
a. Rate Structure	Service Not Provided
b. Total Revenue from Commodity Charges (Volumetric Rates)	\$ 0
c. Total Revenue from Customer Meter/Service (Fixed) Charges	\$ 0
<b>9. Other</b>	
a. Rate Structure	Service Not Provided
b. Total Revenue from Commodity Charges (Volumetric Rates)	\$ 0
c. Total Revenue from Customer Meter/Service (Fixed) Charges	\$ 0

**B. Implementation Options**

**Select Either Option 1 or Option 2:**

**1. Option 1: Use Annual Revenue As Reported**  
 $V/(V+M) \geq 70\%$   
 V = Total annual revenue from volumetric rates Selected  
 M = Total annual revenue from customer meter/service (fixed) charges

**2. Option 2: Use Canadian Water & Wastewater Association Rate Design Model**  
 $V/(V+M) \geq V'/(V'+M')$   
 V = Total annual revenue from volumetric rates  
 M = Total annual revenue from customer meter/service (fixed) charges  
 V' = The uniform volume rate based on the signatory's long-run incremental cost of service  
 M' = The associated meter charge

- a. If you selected Option 2, has your agency submitted to the Council a completed Canadian Water & Wastewater Association rate design model?
- b. Value for **V'** (uniform volume rate based on agency's long-run incremental cost of service) as determined by the Canadian Water & Wastewater Association rate design model:
- c. Value for **M'** (meter charge associated with V' uniform volume rate) as determined by the Canadian Water & Wastewater Association rate design model:

**C. Retail Wastewater (Sewer) Rate Structure Data by Customer Class**

1. Does your agency provide sewer service? (If YES, answer questions 2 - 7 below, else continue to section D.) No

**2. Single Family Residential**

- a. Sewer Rate Structure
- b. Total Annual Revenue \$ 0
- c. Total Revenue from Commodity Charges (Volumetric Rates) \$ 0

**3. Multi-Family Residential**

- a. Sewer Rate Structure
- b. Total Annual Revenue \$ 0
- c. Total Revenue from Commodity Charges (Volumetric Rates) \$ 0

**4. Commercial**

- a. Sewer Rate Structure
- b. Total Annual Revenue \$ 0
- c. Total Revenue from Commodity Charges (Volumetric Rates) \$ 0

**5. Industrial**

- a. Sewer Rate Structure
- b. Total Annual Revenue \$ 0
- c. Total Revenue from Commodity Charges (Volumetric Rates) \$ 0

**6. Institutional / Government**

- a. Sewer Rate Structure
- b. Total Annual Revenue \$ 0
- c. Total Revenue from Commodity Charges (Volumetric Rates) \$ 0

**7. Recycled-reclaimed water**

- a. Sewer Rate Structure
- b. Total Annual Revenue \$ 0
- c. Total Revenue from Commodity Charges (Volumetric Rates) \$ 0

**D. "At Least As Effective As"**

1. Is your agency implementing an "at least as effective as" variant of this BMP? No

a. If YES, please explain in detail how your implementation of this BMP differs from Exhibit 1 and why you consider it to be "at least as effective as."

**E. Comments**

Link to LADWP Water Rate Ordinance:  
<http://www.ladwp.com/ladwp/cms/ladwp001149.pdf>

**BMP 12: Conservation Coordinator**

Reporting Unit: **Los Angeles Dept. of Water and Power**      BMP Form Status: **100% Complete**      Year: **2008**

**A. Implementation**

1. Does your Agency have a conservation coordinator? yes
2. Is a coordinator position supplied by another agency with which you cooperate in a regional conservation program ? no
  - a. Partner agency's name:
3. If your agency supplies the conservation coordinator:
  - a. What percent is this conservation coordinator's position? 100%
  - b. Coordinator's Name Thomas Gackstetter
  - c. Coordinator's Title Water Conservation Manager
  - d. Coordinator's Experience and Number of Years 21
  - e. Date Coordinator's position was created (mm/dd/yyyy) 12/11/1991
4. Number of conservation staff (FTEs), including Conservation Coordinator. 5

**B. Conservation Staff Program Expenditures**

1. Staffing Expenditures (In-house Only) 609562
2. BMP Program Implementation Expenditures 6989200

**C. "At Least As Effective As"**

1. Is your AGENCY implementing an "at least as effective as" variant of this BMP? no
  - a. If YES, please explain in detail how your implementation of this BMP differs from Exhibit 1 and why you consider it to be "at least as effective as."

**D. Comments****BMP 13: Water Waste Prohibition**

Reporting Unit: **Los Angeles Dept. of Water and Power**      BMP Form Status: **100% Complete**      Year: **2008**

**A. Requirements for Documenting BMP Implementation**

1. Is a water waste prohibition ordinance in effect in your service area? yes
  - a. If YES, describe the ordinance:
 

Prohibits use of water on hardscape, gutter flooding, unattended leaks, mid-day watering, serving water in restaurants w/o request, non recirc fountains
2. Is a copy of the most current ordinance(s) on file with CUWCC? yes
  - a. List local jurisdictions in your service area in the first text box and water waste ordinance citations in each jurisdiction in the second text

box:

City of Los Angeles

Ord No. 166080

**B. Implementation**

1. Indicate which of the water uses listed below are prohibited by your agency or service area.

- a. Gutter flooding yes
- b. Single-pass cooling systems for new connections Yes
- c. Non-recirculating systems in all new conveyor or car wash systems Yes
- d. Non-recirculating systems in all new commercial laundry systems Yes
- e. Non-recirculating systems in all new decorative fountains yes
- f. Other, please name yes  
See above

2. Describe measures that prohibit water uses listed above:

Specific ordinance language, monetary penalties, service restrictions/shutoff. Cost of water/wastewater and common practice limits number of single pass systems

**Water Softeners:**

3. Indicate which of the following measures your agency has supported in developing state law:

- a. Allow the sale of more efficient, demand-initiated regenerating DIR models. no
- b. Develop minimum appliance efficiency standards that:
  - i.) Increase the regeneration efficiency standard to at least 3,350 grains of hardness removed per pound of common salt used. no
  - ii.) Implement an identified maximum number of gallons discharged per gallon of soft water produced. no
- c. Allow local agencies, including municipalities and special districts, to set more stringent standards and/or to ban on-site regeneration of water softeners if it is demonstrated and found by the agency governing board that there is an adverse effect on the reclaimed water or groundwater supply. no

4. Does your agency include water softener checks in home water audit programs? no

5. Does your agency include information about DIR and exchange-type water softeners in educational efforts to encourage replacement of less efficient timer models? no

**C. "At Least As Effective As"**

1. Is your AGENCY implementing an "at least as effective as" variant of this BMP? no

- a. If YES, please explain in detail how your implementation of this BMP differs from Exhibit 1 and why you consider it to be "at least as effective as."

**D. Comments**

**BMP 14: Residential ULFT Replacement Programs**

Reporting Unit: **Los Angeles Dept. of Water and Power**      BMP Form Status: **100% Complete**      Year: **2008**

**A. Implementation**

**Number of 1.6 gpf Toilets Replaced by Agency Program During Report Year**

	<b>Single-Family Accounts</b>	<b>Multi-Family Units</b>
1. Does your Agency have program(s) for replacing high-water-using toilets with ultra-low flush toilets?	yes	yes
<b>Replacement Method</b>	<b>SF Accounts</b>	<b>MF Units</b>
2. Rebate	0	42
3. Direct Install	0	0
4. CBO Distribution	0	0
5. Other	0	0
<b>Total</b>	<b>0</b>	<b>42</b>

**Number of 1.2 gpf High-Efficiency Toilets (HETs) Replaced by Agency Program During Report Year**

	<b>Single-Family Accounts</b>	<b>Multi-Family Units</b>
6. Does your Agency have program(s) for replacing high-water-using toilets with ultra-low flush toilets?	no	no
<b>Replacement Method</b>	<b>SF Accounts</b>	<b>MF Units</b>
7. Rebate		
8. Direct Install		
9. CBO Distribution		
10. Other		
<b>Total</b>		

**Number of Dual-Flush Toilets Replaced by Agency Program During Report Year**

	<b>Single-Family Accounts</b>	<b>Multi-Family Units</b>
11. Does your Agency have program(s) for replacing high-water-using toilets with ultra-low flush toilets?	no	no
<b>Replacement Method</b>	<b>SF Accounts</b>	<b>MF Units</b>
12. Rebate	0	0
13. Direct Install	0	0
14. CBO Distribution	0	0
15. Other	0	0
<b>Total</b>	<b>0</b>	<b>0</b>

16. Describe your agency's ULFT, HET, and/or Dual-Flush Toilet programs for

single-family residences.

Residential ULFT rebate and distribution programs ended in 2007.

17. Describe your agency's ULFT, HET, and/or Dual-Flush Toilet programs for multi-family residences.

Residential ULFT rebate and distribution programs ended in 2007.

18. Is a toilet retrofit on resale ordinance in effect for your service area? yes

19. List local jurisdictions in your service area in the left box and ordinance citations in each jurisdiction in the right box:

City of Los Angeles

Ord. No. 172075

### **B. Residential ULFT Program Expenditures**

1. Estimated cost per ULFT/HET replacement: 242.86

### **C. "At Least As Effective As"**

1. Is your AGENCY implementing an "at least as effective as" variant of this BMP? no

a. If YES, please explain in detail how your implementation of this BMP differs from Exhibit 1 and why you consider it to be "at least as effective as."

### **D. Comments**



## **Emergency Water Conservation Plan**



**ORDINANCE NO. 181288**

An ordinance amending Chapter XII, Article I of the Los Angeles Municipal Code to clarify prohibited uses and modify certain water conservation requirements of the Water Conservation Plan of the City of Los Angeles.

**THE PEOPLE OF THE CITY OF LOS ANGELES  
DO ORDAIN AS FOLLOWS:**

Section 1. Chapter XII, Article I, of the Los Angeles Municipal Code is amended in its entirety to read:

**ARTICLE I  
EMERGENCY WATER CONSERVATION PLAN**

**SEC. 121.00. SCOPE AND TITLE.**

This Article shall be known as The Emergency Water Conservation Plan of the City of Los Angeles.

**SEC. 121.01. DECLARATION OF POLICY.**

It is hereby declared that because of the conditions prevailing in the City of Los Angeles and in the areas of this State and elsewhere from which the City obtains its water supplies, the general welfare requires that the water resources available to the City be put to the maximum beneficial use to the extent to which they are capable, and that the waste or unreasonable use or unreasonable method of use of water be prevented, and the conservation of such waters is to be exercised with a view to the reasonable and beneficial use thereof in the interests of the people of the City and for the public welfare.

**SEC. 121.02. DECLARATION OF PURPOSE.**

The purpose of this Article is to provide a mandatory water conservation plan to minimize the effect of a shortage of water to the Customers of the City and, by means of this Article, to adopt provisions that will significantly reduce the consumption of water over an extended period of time, thereby extending the available water required for the Customers of the City while reducing the hardship of the City and the general public to the greatest extent possible, voluntary conservation efforts having proved to be insufficient.

**SEC. 121.03. DEFINITIONS**

The following words and phrases, whenever used in this Article, shall be construed as defined in this Section unless from the context a different meaning is

intended or unless a different meaning is specifically defined within individual Sections of this Article:

- a. **“Article”** means the ordinance providing for **“The Emergency Water Conservation Plan of the City of Los Angeles”**.
- b. **“Baseline Water Usage”** means the amount of water used for the same period during Fiscal Year 2006-2007. The Baseline Water Usage for Customers without a water usage history prior to 2007 shall be calculated pursuant to a Department water budget.
- c. **“Billing Unit”** means the unit amount of water used to apply water rates for purposes of calculating commodity charges for Customer water usage and equals one hundred (100) cubic feet or seven hundred forty-eight (748) gallons of water.
- d. **“City”** means the City of Los Angeles.
- e. **“City Council”** means the Council of the City of Los Angeles.
- f. **“Conservation Phase”** means that level of mandatory water conservation presently required from Customers pursuant to this Article.
- g. **“Customer”** means any person, persons, association, corporation or governmental agency supplied or entitled to be supplied with water service by the Department.
- h. **“Department”** means the Los Angeles Department of Water and Power.
- i. **“Drip Irrigation”** means an efficient and targeted form of irrigation in which water is delivered in drops directly to the plants roots where no emitter produces more than four (4) gallons of water per hour.
- j. **“Even-numbered”** means street addresses ending with the following numerals: 0 (Zero), 2 (Two), 4 (Four), 6 (Six), 8 (Eight). Street addresses ending in  $\frac{1}{2}$  or any fraction shall conform to the permitted uses for the last whole number in the address.
- k. **“Gray Water”** means a Customer’s second or subsequent use of water supplied by the Department on the Customer’s premises, such as the use of laundry or bathing water for other purposes.
- l. **“His”** as used herein includes masculine, feminine or neuter, as appropriate.

- m. **“Irrigate”** means any exterior application of water, other than for firefighting purposes, dust control, or as process water, including but not limited to the watering of any vegetation whether it be natural or planted.
- n. **“Large Landscape Area”** means an area of vegetation at least three acres in size supporting a business necessity or public benefit uses such as parks, golf courses, schools, and cemeteries, and includes without limitation Schedule F and Provision M rate Customers.
- o. **“Mayor”** means the Mayor of the City of Los Angeles
- p. **“Notice to the Department”** means written communication documenting compliance with all requirements and directed to the Department.
- q. **“Odd-numbered”** means street addresses ending with the following numerals: 1 (One), 3 (Three), 5 (Five), 7 (Seven), 9 (Nine). Street addresses ending in ½ or any fraction shall conform to the permitted uses for the last whole number in the address.
- r. **“Officer”** means every person designated in Section 200 of the Los Angeles City Charter as an officer of the City of Los Angeles.
- s. **“Potable Water”** means water supplied by the Department which is suitable for drinking and excludes recycled water from any source.
- t. **“Private Golf Course”** means a facility with a business license where play is restricted to members and their guests, and does not include personal use facilities such as backyard golf greens or courses.
- u. **“Process Water”** means water used to manufacture, alter, convert, clean, heat, or cool a product, or the equipment used for such purpose; water used for plant and equipment washing and for transporting of raw materials and products; and water used for community gardens, or to grow trees, plants, or turf for sale or installation.
- v. **“Recycled Water”** means water which as a result of treatment of wastewater, is suitable for a direct beneficial use, or a controlled use as approved by the California Department of Public Health.
- w. **“Section”** means a section of this Article unless some other ordinance or statute is specifically mentioned.
- x. **“Single pass cooling systems”** means equipment where water is circulated only once to cool equipment before being disposed.

- y. **“Sports Fields”** means a public or private facility supporting a business necessity or public benefit use that provides turf areas as a playing surface for individual and team sports, and does not include a facility on a residential property.
- z. **“Station”** means those sprinklers or other water-emitting devices controlled by a single valve.

#### **SEC. 121.04. AUTHORIZATION.**

The various officers, boards, departments, bureaus and agencies of the City are hereby authorized and directed to immediately implement the applicable provisions of this Article upon the effective date hereof.

#### **SEC. 121.05. APPLICATION.**

The provisions of this Article shall apply to all Customers and property served by the Department wherever situated, and shall also apply to all property and facilities owned, maintained, operated, or under the jurisdiction of the various officers, boards, departments, bureaus or agencies of the City.

#### **SEC. 121.06. WATER CONSERVATION PHASES.**

**A.** No Customer of the Department shall make, cause, use, or permit the use of water from the Department for any residential, commercial, industrial, agricultural, governmental, or any other purpose in a manner contrary to any provision of this Article. The waste or unreasonable use of water is prohibited.

**B.** For the purposes of this Article, a use of water by a tenant or by an employee, agent, contractor or other designee acting on behalf of a Customer whether with real or ostensible authority shall be imputed to the Customer. Nothing contained in this Article shall limit the remedies available to a Customer under law or equity for the actions of a tenant, agent, contractor or other acting on behalf of a Customer.

#### **SEC. 121.07. CONSERVATION PHASE IMPLEMENTATION.**

**A.** Notwithstanding any other provisions of this Article, the provisions of Section 121.08A, Phase I, Prohibited Uses applicable to all Customers, shall take effect immediately upon the effective date of this Article, shall be permanent and shall not be subject to termination pursuant to the provisions of this Article providing for the termination of a conservation phase.

**B.** The Department shall monitor and evaluate the projected supply and demand for water by its Customers monthly, and shall recommend to the Mayor and Council by concurrent written notice the extent of the conservation required by the Customers of the Department in order for the Department to prudently plan for and

supply water to its Customers. The Mayor shall, in turn, independently evaluate such recommendation and notify the Council of the Mayor's determination as to the particular phase of water conservation, Phase I through Phase V that should be implemented. Thereafter, the Mayor may, with the concurrence of the Council, order that the appropriate phase of water conservation be implemented in accordance with the applicable provisions of this Article. Said order shall be made by public proclamation and shall be published one time only in a daily newspaper of general circulation and shall become effective immediately upon such publication. The prohibited water uses for each phase shall take effect with the first full billing period commencing on or after the effective date of the public proclamation by the Mayor.

In the event the Mayor independently recommends to the Council a phase of conservation different from that recommended by the Department, the Mayor shall include detailed supporting data and the reasons for the independent recommendation in the notification to the Council of the Mayor's determination as to the appropriate phase of conservation to be implemented.

#### **C. Phase Termination**

1. At such time as the Department reports an April 1 forecast of annual Owens Valley and Mono Basin Runoff equal to or exceeding 110 percent of normal and the Metropolitan Water District of Southern California officially states that the sum of its Colorado River and State Water Project supplies exceeds 100 percent of projected demand, the Mayor shall forthwith recommend to the Council the termination of any Customer curtailment phase then in effect. Said recommendation to terminate shall take effect upon concurrence of the Council.

2. The provisions of Subsection C1 above shall not preclude the Department on the basis of information available to it from recommending to the Mayor the termination of a water conservation phase then in effect. The Mayor shall forward said recommendation to the Council and it shall take effect upon concurrence by the Council.

### **SEC. 121.08. WATER CONSERVATION PHASES.**

#### **A. PHASE I**

##### **Prohibited Uses Applicable To All Customers.**

1. No Customer of the Department shall use a water hose to wash any paved surfaces including, but not limited to, sidewalks, walkways, driveways, and parking areas, except to alleviate immediate safety or sanitation hazards. This Section shall not apply to Department-approved water-conserving spray cleaning devices. Use of water-pressure devices for graffiti removal is exempt. A simple spray nozzle does not qualify as a water-conserving spray cleaning device.

2. No Customer of the Department shall use water to clean, fill, or maintain levels in decorative fountains, ponds, lakes, or similar structures used for aesthetic purposes unless such water is part of a recirculating system.

3. No restaurant, hotel, café, cafeteria, or other public place where food is sold, served or offered for-sale, shall serve drinking water to any person unless expressly requested.

4. No Customer of the Department shall permit water to leak from any pipe or fixture on the Customer's premises; failure or refusal to effect a timely repair of any leak of which the Customer knows or has reason to know shall subject said Customer to all penalties provided herein for a prohibited use of water.

5. No Customer of the Department shall wash a vehicle with a hose if the hose does not have a self-closing water shut-off or device attached to it, or otherwise allow a hose to run continuously while washing a vehicle.

6. No Customer of the Department shall irrigate during periods of rain.

7. No Customer of the Department shall water or irrigate lawn, landscape, or other vegetated areas between the hours of 9:00 a.m. and 4:00 p.m. During these hours, public and private golf course greens and tees and professional sports fields may be irrigated in order to maintain play areas and accommodate event schedules. Supervised testing or repairing of irrigation systems is allowed anytime with proper signage.

8. All irrigating of landscape with potable water using spray head sprinklers and bubblers shall be limited to no more than ten (10) minutes per watering day per station. All irrigating of landscape with potable water using standard rotors and multi-stream rotary heads shall be limited to no more than fifteen (15) minutes per cycle and up to two (2) cycles per watering day per station. Exempt from these landscape irrigation restrictions are irrigation systems using very low-flow drip-type irrigation when no emitter produces more than four (4) gallons of water per hour and micro-sprinklers using less than fourteen (14) gallons per hour. This provision does not apply to Schedule F water Customers or water service that has been granted the General Provision M rate adjustment under the City's Water Rates Ordinance, subject to the Customer having complied with best management practices for irrigation approved by the Department. The 9:00 a.m. to 4:00 p.m. irrigation restriction shall apply unless specifically exempt as stated in subsection 7 above.

9. No Customer of the Department shall water or irrigate any lawn, landscape, or other vegetated area in a manner that causes or allows excess or continuous water flow or runoff onto an adjoining sidewalk, driveway, street, gutter or ditch.



10. No installation of single pass cooling systems shall be permitted in buildings requesting new water service.

11. No installation of non-recirculating systems shall be permitted in new conveyor car wash and new commercial laundry systems.

12. Operators of hotels and motels shall provide guests with the option of choosing not to have towels and linens laundered daily. The hotel or motel shall prominently display notice of this option in each bathroom using clear and easily understood language. The Department shall make suitable displays available.

13. No Large Landscape Areas shall have irrigation systems without rain sensors that shut off the irrigation systems. Large Landscape Areas with approved weather-based irrigation controllers registered with the Department are in compliance with this requirement.

## **B. PHASE II**

1. **Prohibited Uses Applicable To All Customers.** Should Phase II be implemented, uses applicable to Phase I of this Section shall continue to be applicable, except as specifically provided below.

2. **Non-Watering Days.** No landscape irrigation shall be permitted on any day other than Monday, Wednesday, or Friday for odd-numbered street addresses and Tuesday, Thursday, or Sunday for even-numbered street addresses. Street addresses ending in  $\frac{1}{2}$  or any fraction shall conform to the permitted uses for the last whole number in the address. Watering times shall be limited to:

(a) Non-conserving nozzles (spray head sprinklers and bubblers) – no more than eight (8) minutes per watering day per station for a total of 24 minutes per week.

(b) Conserving nozzles (standard rotors and multi-stream rotary heads) – no more than fifteen (15) minutes per cycle and up to two (2) cycles per watering day per station for a total of 90 minutes per week.

(With the above watering times, water consumption used for both types of nozzles is essentially equal.)

3. Upon written Notice to the Department, irrigation of Sports Fields may deviate from the non-watering days to maintain play areas and accommodate event schedules; however, to be eligible for this means of compliance, a Customer must reduce his overall monthly water use by the Department's Board of Water and Power Commissioners (Board)-adopted

degree of shortage plus an additional five percent from the Customer Baseline Water Usage within 30 days.

4. Upon written Notice to the Department, Large Landscape Areas may deviate from the non-watering days by meeting the following requirements: 1) must have approved weather-based irrigation controllers registered with the Department (eligible weather-based irrigation controllers are those approved by the Metropolitan Water District of Southern California or the Irrigation Association Smart Water Application Technologies [SWAT] initiative); 2) must reduce overall monthly water use by the Department's Board-adopted degree of shortage plus an additional five percent from the Customer Baseline Water Usage within 30 days; and 3) must use recycled water if it is available from the Department.

5. These provisions do not apply to drip irrigation supplying water to a food source or to hand-held hose watering of vegetation, if the hose is equipped with a self-closing water shut-off device, which is allowed everyday during Phase II except between the hours of 9:00 am and 4:00 pm.

### C. PHASE III

1. **Prohibited Uses Applicable to All Customers.** Should Phase III be implemented, uses applicable to Phase I of this Section shall continue to be applicable, except as specifically provided below.

2. **Non-Watering Days.** No landscape irrigation shall be permitted on any day other than Monday for odd-numbered street addresses and Tuesday for even-numbered street addresses. Street addresses ending in  $\frac{1}{2}$  or any fraction shall conform to the permitted uses for the last whole number in the address.

3. No washing of vehicles allowed except at commercial car wash facilities.

4. No filling of residential swimming pools and spas with potable water.

5. Upon written Notice to the Department, irrigation of Sports Fields may deviate from the specific non-watering days and be granted one additional watering day (for a total of 2 days allowed). To be eligible for this means of compliance, a Customer must reduce overall monthly water use by the Department's Board-adopted degree of shortage plus an additional ten percent from the Customer Baseline Water Usage within 30 days.

6. Upon written Notice to the Department, Large Landscape Areas may deviate from the specific non-watering days and be granted one additional watering day (for a total of 2 days allowed) by meeting the following requirements: 1) must have approved weather-based irrigation controllers

registered with the Department (eligible weather-based irrigation controllers are those approved by the Metropolitan Water District of Southern California or the Irrigation Association Smart Water Application Technologies [SWAT] initiative); 2) must reduce overall monthly water use by the Department's Board-adopted degree of shortage plus an additional ten percent from the Customer Baseline Water Usage within 30 days; and 3) must use recycled water if it is available from the Department.

7. These provisions do not apply to drip irrigation supplying water to a food source or to hand-held hose watering of vegetation, if the hose is equipped with a self-closing water shut-off device, which is allowed everyday during Phase IV except between the hours of 9:00 a.m. and 4:00 p.m.

#### **D. PHASE IV**

1. **Prohibited Uses Applicable To All Customers.** Should Phase IV be implemented, uses applicable to Phases I, II, and III of this Section shall continue to be applicable, except as specifically provided below.

2. **Non-Watering Days.** No landscape irrigation allowed.

#### **E. PHASE V**

1. **Prohibited Uses Applicable To All Customers.** Phases I, II, III, and IV of Section 121.08 shall continue to remain in effect.

2. **Additional Prohibited Uses -** The Board is hereby authorized to implement additional prohibited uses of water based on the water supply situation. Any additional prohibition shall be published at least once in a daily newspaper of general circulation and shall become effective immediately upon such publication and shall remain in effect until cancelled.

**F. EXCEPTION.** The prohibited uses of water provided for by Subsections A, B, C, D, and E of this Section are not applicable to the uses of water necessary for public health and safety or for essential government services such as police, fire, and other similar emergency services.

**G. VARIANCE.** If, due to unique circumstances, a specific requirement of this Section would result in undue hardship to a Customer using water or to property upon which water is used, that is disproportionate to the impacts to water users generally or to similar property or classes of water uses, then the Customer may apply for a variance from the requirements. Unique circumstances include, but are not limited to, physical disabilities which prevent compliance with the Water Conservation Plan. The Department shall adopt procedures for variance applications, review, and decision.

## **SEC. 121.09 FAILURE TO COMPLY.**

**A. Penalties – Water Meters Smaller Than Two Inches (2”).** It shall be unlawful for any Customer of the Department to fail to comply with any of the provisions of this Article. Notwithstanding any other provision of the Los Angeles Municipal Code, the penalties set forth herein shall be exclusive and not cumulative with any other provisions of this Code. The penalties for failure to comply with any of the provisions of this Article shall be as follows:

1. For the first violation by any Customer of any of the provisions of Subsection A, B, C and D of Section 121.08, the Department shall issue a written notice of the fact of such violation to the Customer.

2. For a second violation by any Customer of any of the provisions of Subsection A, B, C and D of Section 121.08 within the preceding twelve (12) calendar months, a surcharge in the amount of One Hundred Dollars (\$100.00) shall be added to the Customer's water bill.

3. For a third violation by any Customer of any of the provisions of Subsection A, B, C and D of Section 121.08 within the preceding twelve (12) calendar months, a surcharge in the amount of Two Hundred Dollars (\$200.00) shall be added to the Customer's water bill.

4. For a fourth and any subsequent violation by a Customer of any of the provisions of Subsection A, B, C and D of Section 121.08 within the preceding twelve (12) calendar months, a surcharge in the amount of Three Hundred Dollars (\$300.00) shall be added to the Customer's water bill.

5. After a fifth or subsequent violation, the Department may install a flow-restricting device of one-gallon-per-minute (1 GPM) capacity for services up to one and one-half inch (1-1/2”) size and comparatively sized restrictors for larger services or terminate a Customer's service, in addition to the financial surcharges provided for herein. Such action shall be taken only after a hearing held by the Department where the Customer has an opportunity to respond to the Department's information or evidence that the Customer has repeatedly violated this Article or Department rules regarding the conservation of water and that such action is reasonably necessary to assure compliance with this Article and Department rules regarding the conservation of water.

Any such restricted or terminated service may be restored upon application of the Customer made not less than forty-eight (48) hours after the implementation of the action restricting or terminating service and only upon a showing by the Customer that the Customer is ready, willing and able to comply with the provisions of this Article and Department rules

regarding the conservation of water. Prior to any restoration of service, the Customer shall pay all Department charges for any restriction or termination of service and its restoration as provided for in the Department's rules governing water service, including but not limited to payment of all past due bills and fines.

**B. Penalties – Water Meters Two Inches (2”) and Larger.** It shall be unlawful for any Customer of the Department to fail to comply with any of the provisions of this Article. Notwithstanding any other provision of the Los Angeles Municipal Code, the penalties set forth herein shall be exclusive and not cumulative with any other provisions of this Code. The penalties for failure to comply with any of the provisions of this Article shall be as follows:

1. For the first violation by any Customer of any of the provisions of Subsection A, B, C and D of Section 121.08, the Department shall issue a written notice of the fact of such violation to the commercial or industrial Customer.

2. For a second violation by any Customer of any of the provisions of Subsection A, B, C and D of Section 121.08 within the preceding twelve (12) calendar months, a surcharge in the amount of Two Hundred Dollars (\$200.00) shall be added to the Customer's water bill.

3. For a third violation by any Customer of any of the provisions of Subsection A, B, C and D of Section 121.08 within the preceding twelve (12) calendar months, a surcharge in the amount of Four Hundred Dollars (\$400.00) shall be added to the Customer's water bill.

4. For a fourth and any subsequent violation by a Customer of any of the provisions of Subsection A, B, C and D of Section 121.08 within the preceding twelve (12) calendar months, a surcharge in the amount of Six Hundred Dollars (\$600.00) shall be added to the Customer's water bill.

5. After a fifth or subsequent violation, the Department may install a flow-restricting device or terminate a Customer's service, in addition to the financial surcharges provided for herein. Such action shall be taken only after a hearing held by the Department where the Customer has an opportunity to respond to the Department's information or evidence that the Customer has repeatedly violated this Article or Department rules regarding the conservation of water and that such action is reasonably necessary to assure compliance with this Article and Department rules regarding the conservation of water.

Any such restricted or terminated service may be restored upon application of the Customer made not less than forty-eight (48) hours after the implementation of the action restricting or terminating service and only

upon a showing by the Customer that the Customer is ready, willing and able to comply with the provisions of this Article and Department rules regarding the conservation of water. Prior to any restoration of service, the Customer shall pay all Department charges for any restriction or termination of service and its restoration as provided for in the Department's rules governing water service, including but not limited to payment of all past due bills and fines.

**C. Notice.** The Department shall give notice of each violation to the Customer committing such violation as follows:

1. For any violation of the provisions of Section 121.08, the Department may give written notice of the fact of such violation to the Customer personally, by posting a notice at a conspicuous place on the Customer's premises, or by United States mail, First-Class, postage prepaid addressed to the Customer's billing address.

2. If the penalty assessed is, or includes, the installation of a flow restrictor or the termination of water service to the Customer, notice of the violation shall be given in the following manner:

(a) By giving written notice thereof to the Customer personally; or

(b) If the Customer is absent from or unavailable at either his place of residence or his place of business, by leaving a copy with some person of suitable age and discretion at either place, and sending a copy through the United States mail, First-Class postage prepaid, addressed to the Customer at his place of business, residence, or such other address provided by the Customer for bills for water or electric service if such can be ascertained; or

(c) If such place of residence, business or other address cannot be ascertained, or a person of suitable age or discretion at any such place cannot be found, then by affixing a copy in a conspicuous place on the property where the failure to comply is occurring and also by delivering a copy to a person of suitable age and discretion there residing, or employed, if such person can be found, and also sending a copy through the United States mail, First-Class, postage prepaid, addressed to the Customer at the place where the property is situated as well as such other address provided by the Customer for bills for water or electric service if such can be ascertained.

Said notice shall contain, in addition to the facts of the violation, a statement of the possible penalties for each violation and statement informing the Customer of his right to a hearing on the violation.

**D. Hearing.** Any Customer who disputes any penalty levied pursuant to this Section shall have a right to a dispute determination conducted pursuant to the Department's Rules Governing Water and Electric Service. Any Customer dissatisfied with the Department's dispute determination may appeal that determination within 15 days of issuance to the Board, or to a designated hearing officer at the election of the Board. The provisions of Sections 19.24, 19.25, 19.26 and Sections 19.29 through 19.39 of the Los Angeles Administrative Code shall apply to such appeals. All defenses, both equitable and legal, may be asserted by a Customer in the appeal process. The decisions of the Board shall become final at the expiration of 45 calendar days, unless the Council acts within that time by a majority vote to bring the action before it or to waive review of the action. If the Council timely asserts jurisdiction, the Council may, by a majority vote, amend, veto or approve the action of the Board within 21 calendar days of voting to bring the matter before it, or the action of the Board shall become final. If the City Council asserts jurisdiction over the matter and acts within 21 calendar days of voting to bring the matter before it, the City Council's action shall be the final decision.

**E. Reservation of Rights.** The rights of the Department hereunder shall be cumulative to any other right of the Department to discontinue service. All monies collected by the Department pursuant to any of the surcharge provisions of this Article shall be deposited in the Water Revenue Fund as reimbursement for the Department's costs and expenses of administering and enforcing this Article.

#### **SEC. 121.10. GENERAL PROVISIONS.**

**A. Enforcement.** The Department of Water and Power shall enforce the provisions of this Article.

**B. Department to Give Effect to Legislative Intent.** The Department shall provide water to its Customers in accordance with the provisions of this Article, and in a manner reasonably calculated to effectuate the intent hereof.

**C. Public Health and Safety Not to be Affected.** Nothing contained in this Article shall be construed to require the Department to curtail the supply of water to any Customer when, in the discretion of the Department, such water is required by that Customer to maintain an adequate level of public health and safety; provided further that a Customer's use of water to wash the Customer's

property immediately following the aerial application of a pesticide, such as Malathion, shall not constitute a violation of this Article.

**D. Recycled Water and Gray Water.** The provisions of this Article shall not apply to the use of Recycled Water or Gray Water, provided that such use does not result in excess water flow or runoff onto the adjoining sidewalk, driveway, street, gutter, or ditch. This provision shall not be construed to authorize the use of Gray Water if such use is otherwise prohibited by law.

**E. Large Landscape Areas.** Large Landscape Areas that have multiple irrigation system stations can deviate from prescribed non-watering days if their systems include weather-based irrigation controllers, and each irrigation station is limited to the number of days prescribed in this ordinance.

**F. Hillside Burn Areas.** The provisions of this Article shall not apply to hillside areas recovering from fire that have been replanted for erosion control. To qualify for this exemption, a Customer must obtain verification from the agency requiring erosion control measures. The duration of the exemption is limited to, either, one growing cycle, one year, or establishment of the vegetation, whichever is the lesser time period.

#### **SEC. 121.11. SEVERABILITY.**

If any section, subsection, clause or phrase in this Article or the application thereof to any person or circumstances is for any reason held invalid, the validity of the remainder of the Article or the application of such provision to other persons or circumstances shall not be affected thereby. The City Council hereby declares that it would have passed this Article and each section, subsection, sentence, clause, or phrase thereof, irrespective of the fact that one or more sections, subsections, sentences, clauses, or phrases or the application thereof to any person or circumstance be held invalid.

#### **Sec. 2. URGENCY CLAUSE.**

The Council of the City of Los Angeles hereby finds and declares that there exists within this City a current water shortage and the likelihood of a continuing water shortage into the immediate future and that as a result there is an urgent necessity to take legislative action through the exercise of the police power to protect the public peace, health, and safety of this City from a public disaster or calamity. Therefore, this Ordinance shall take effect immediately upon publication.

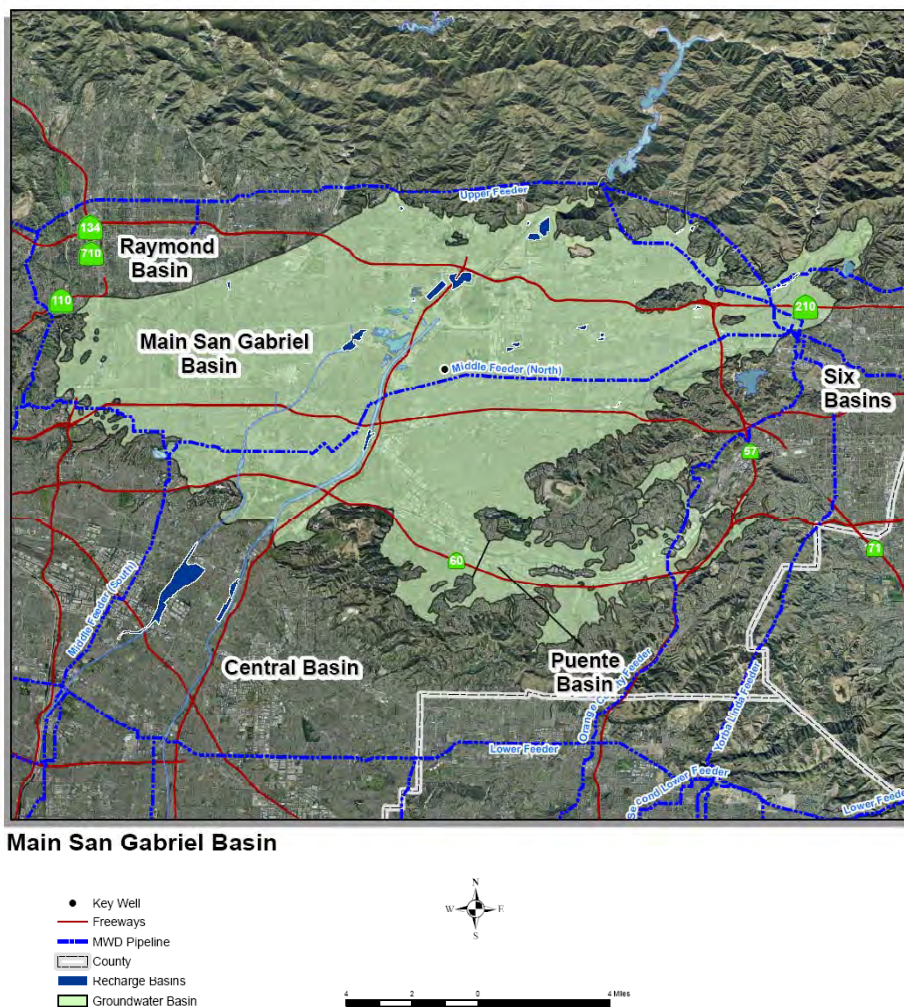


# Chapter IV – Groundwater Basin Reports

## San Gabriel Valley Basins - Main San Gabriel and Puente Basins

The Main San Gabriel and Puente Basins lie in eastern Los Angeles County, California. The hydrologic basin or watershed coincides with a portion of the upper San Gabriel River watershed, and the aquifer or groundwater basin underlies most of the San Gabriel Valley. Metropolitan member agencies overlying the Main San Gabriel Basin (or Main Basin) include: Upper San Gabriel Municipal Water District (Upper District), Three Valleys Municipal Water District (Three Valleys) and the City of San Marino. The service areas of three member agencies (cities of Azusa, Alhambra and Monterey Park) of the State Water Project contractor, San Gabriel Valley Municipal Water District (SGVMWD), also overlie the Main San Gabriel Basin. The Metropolitan member agency overlying the Puente Basin is Three Valleys. Overlying communities include: Arcadia, Azusa, Baldwin Park, Bradbury, Covina, Duarte, El Monte, Glendora, Industry, Irwindale, La Puente, Monrovia, Rosemead, San Gabriel, San Marino, South El Monte, South Pasadena, Temple City, Walnut, and West Covina. A map of the Main San Gabriel and Puente Basins is provided in **Figure 7-1**.

**Figure 7-1**  
**Map of the Main San Gabriel and Puente Basins**



## BASIN CHARACTERIZATION

The following section provides a physical description of the Main San Gabriel and Puente Basins including geographic location and hydrogeologic character.

### Basin Producing Zones and Storage Capacity

The Main San Gabriel and Puente Basins are bounded by the San Gabriel Mountains to the north, San Jose Hills to the east, Puente Hills to the south, and by a series of hills and the Raymond Fault to the west. The watershed is drained by the San Gabriel River and Rio Hondo, a tributary of the Los Angeles River.

The physical groundwater basin is divided into two main parts, the Main Basin and the Puente Basin. The Puente Basin, lying in the southeast portion of the map above, is tributary to the Main Basin and hydraulically connected to it, with no barriers to groundwater movement. Each basin is separately adjudicated and managed by a watermaster. **Table 7-1** provides a summary of the hydrogeologic parameters of the Main San Gabriel and Puente Basins. Each basin is discussed separately in the following section.

**Table 7-1**  
**Summary of Hydrogeologic Parameters of Main San Gabriel and Puente Basins**

Parameter	Main San Gabriel Basin	Puente Basin
<b>Structure</b>		
Aquifer(s)	Unconfined	Unconfined
Depth of groundwater basin	800 to 1,600 feet MSL	25 to 1,300 feet
Thickness of water-bearing units	300 to 2,000 feet	70 to 200 feet
<b>Yield and Storage</b>		
Natural Safe Yield	152,700 AFY	4,400 AFY
Operating Yield	FY 2005/06: 240,000 AFY	FY 2006/07: 1,530 AFY
Total Storage	8.6 million AF	979,650 AF
Unused Storage Space	~500,000 AF	Unknown
Portion of Unused Storage Available for Storage (in 2005/06)	None	Unknown

Sources: Stetson, 2006 and Main San Gabriel Basin Watermaster, 2006  
 Puente Basin Watermaster, 2006; Ecological Systems Corporation, 1975; Geotechnical Consultants, Inc, 1979; CH2MHill, 1997. Main San Gabriel Basin

### **Main San Gabriel Basin**

The Main San Gabriel Basin occupies most of the San Gabriel Valley and encompasses a surface area of more than 73,000 acres. Principal water-bearing formations of the Main Basin are unconsolidated and semi-consolidated unconfined alluvial sediments that range in size from coarse gravel to fine-grained sands. Total thickness of water-bearing sediments ranges from about 300 feet to more than 2,000 feet (Stetson, 2006).

The total amount of water in storage for the Main San Gabriel Basin is approximately 8.6 million AF (Main San Gabriel Watermaster, 2006b). Usable storage within the operating range is approximately 800,000 AF while the unused storage space is about 500,000 AF (Stetson, 2006). Supplemental imported water cannot be stored in the Main San Gabriel Basin when the groundwater elevation at the key well exceeds 250 feet MSL. Water levels at this time are near or above the target level. Therefore, available storage space for supplemental water is currently limited.

### **Puente Basin**

The Puente Basin occupies the western end of the San Jose Valley and contains nearly 8,870 acres. For the most part, the basin is relatively shallow, and in several locations, bedrock is found at the surface. Boundaries of the Puente Basin are formed on the north and south by the nonwater-bearing rocks of the San Jose and Puente Hills. The eastern boundary is contiguous with the western boundary of the Spadra Basin and is defined by a bedrock ridge and groundwater divide. As discussed above, the Puente Basin is bounded by the Main San Gabriel Basin to the west. Groundwater freely flows from the Puente Basin into the Main San Gabriel Basin. (Engineering Science, Inc, 1979).

Primary water-bearing sediments include weathered alluvium from the adjacent hills and recent deposits within San Jose Creek. The alluvial fill in the Puente Basin tends to be finer-grained and has higher clay content than the sediments in the Main Basin and ranges in depth from 25 feet to 1,300 feet (CH2MHill, 1997). Water-bearing sediments range in thickness between 70 and 120 feet throughout most of the basin but increase in thickness toward the west (maximum thickness of about 500 feet near the boundary with the Main Basin (Engineering Science, Inc, 1979; Ecological Systems Corporation, 1975). Well depths range from about 75 feet to 300 feet in the Puente Basin (Engineering Science, Inc, 1979). Total storage within the Puente Basin has been estimated to be approximately 979,650 AF (Engineering Science Inc, 1979).

### **Safe Yield/Long-Term Balance of Recharge and Discharge**

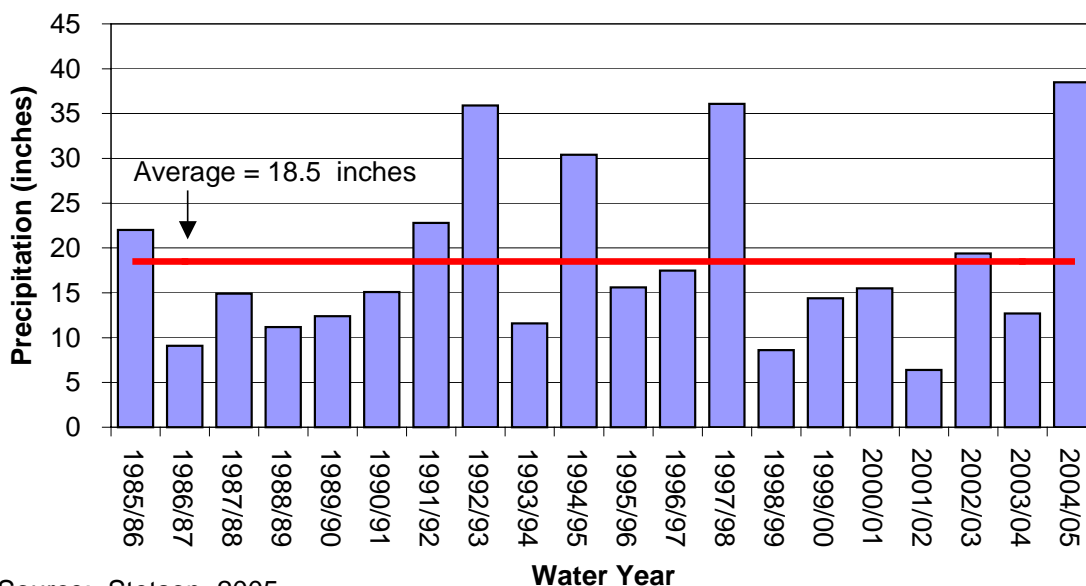
The natural sources of recharge and long-term balance for the Main San Gabriel and Puente Basins are discussed separately in the following section.

### Main San Gabriel Basin

The major sources of natural recharge to the Main San Gabriel Basin are infiltration of rainfall on the valley floor and percolation of runoff from the adjacent mountains. Historical precipitation in the Main San Gabriel Basin is summarized in **Figure 7-2**. The average precipitation over the past 20 years is approximately 18.5 inches. The basin also receives imported water and return flow from applied water.

According to the Main San Gabriel Basin Judgment (discussed below), the natural safe yield of the Main San Gabriel Basin is defined as 152,700 AFY (Main San Gabriel Basin Judgment, 1989).

**Figure 7-2**  
**Historical Precipitation in the Main San Gabriel Basin**



Source: Stetson, 2005

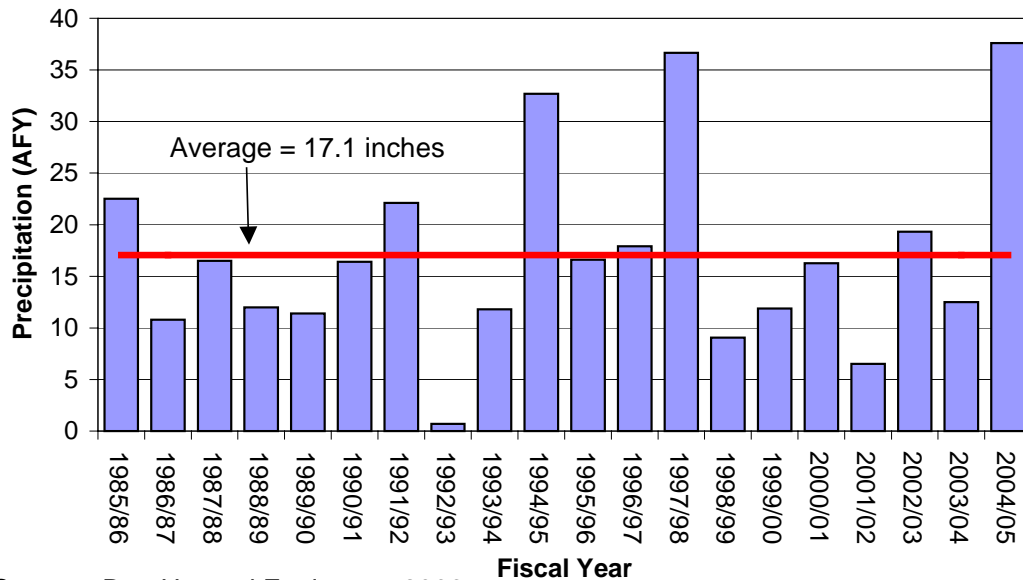
The Operating Safe Yield (OSY) is the quantity of water that the Main San Gabriel Basin Watermaster (Watermaster) determines may be pumped from the Basin in a fiscal year, without Replacement Water assessments. Watermaster considers a wide range of data in setting the OSY, including provisions of the Main San Gabriel Basin Judgment, key well water level, current hydrologic conditions in the basin such as precipitation, storage of local runoff in surface reservoirs, conservation of local runoff, amount of water in cyclic storage accounts, carryover rights and others. In accordance with the Main San Gabriel Basin Judgment, Watermaster at its regular meeting in May of each year determines the OSY applicable to the succeeding fiscal year (July 1 through June 30) and estimates the OSY for the next succeeding four fiscal years. On May 11, 2005, Watermaster adopted an OSY of 240,000 AF for fiscal year 2005-06 and an estimated OSY of 210,000 AF for fiscal year 2006-07.

Since 1975, Watermaster has used cyclic storage accounts to store imported water against future replenishment requirement. Three current cyclic storage accounts (Metropolitan Water District on behalf of its member agencies (140,000 AF) and San Gabriel Valley Municipal Water District (40,000 AF), totaling 180,000 AF of potential water storage capacity are maintained for providing supplemental water to the basin. These accounts allow delivery of imported water when it is available and the water is stored in the basin for sale to Watermaster at a later date.

### Puente Basin

The major sources of natural recharge to the Puente Basin are infiltration of rainfall on the valley floor and percolation of runoff from the adjacent mountains. In addition, water is imported into the basin from the Pomona Water Reclamation Plant (recycled water) and from Metropolitan via the Rowland and Walnut water districts (CH2MHill, 1997). Historical precipitation in the Puente Basin is summarized in **Figure 7-3**. The average precipitation over the past 20 years has been approximately 17.1 inches, lower than the long-term average of about 18 inches per year. The basin also receives imported water and return flows from applied water.

**Figure 7-3**  
**Historical Precipitation in the Puente Basin**



Source: Don Howard Engineers, 2006

According to the Puente Basin Judgment (discussed below), the declared safe yield of the Puente Basin is 4,400 AFY (Puente Basin Judgment, 1986). However, the basin is managed on the basis of Operating Safe Yield determined annually by the Watermaster and has averaged 1,666 AFY since 1988.

The Operating Safe Yield (OSY) is the quantity of water that the Puente Basin Watermaster (Watermaster) determines may be pumped from the basin in a fiscal year. Watermaster

determines the OSY in consideration of five factors specified in the Judgment: water levels, Puente Narrows Agreement, subsurface flows, cost of availability of alternate sources of water, and groundwater pumping. In accordance with the Puente Basin Judgment, Watermaster makes the preliminary determination of OSY by the first Monday in April for upcoming fiscal year and estimates the OSY for the next succeeding four fiscal years. On April 27, 2006, Watermaster adopted an OSY of 1,530 AF for fiscal year 2006-07 and an estimated OSY of 1,500 AF for the subsequent four years.

## **GROUNDWATER MANAGEMENT**

The following section describes how the Main San Gabriel and Puente Basins are currently managed. This includes a discussion of the governing structure and relationship with adjoining basins.

### **Basin Governance**

The following section describes the governing structure and adjudication of the Main San Gabriel and Puente Basins. A summary of the agencies contributing to the management of each basin is provided in **Table 7-2**.

#### **Main San Gabriel Basin**

The Main San Gabriel Basin is an adjudicated basin. On January 4, 1973, after extensive negotiations, a stipulated Judgment in this case was entered (Main San Gabriel Basin Judgment) that created Watermaster, governing body and specified a program for management of water in the Main Basin. Since the Main San Gabriel Basin Judgment was originally entered, there have been subsequent amendments to it that extend and clarify Watermaster's role.

The Watermaster is a nine-person board appointed by the Los Angeles County Superior Court that administers and enforces the provisions of the Main San Gabriel Basin Judgment, which established water rights and responsibility for efficient management of the quantity and quality of the Basin's groundwater. The Watermaster manages and controls the withdrawal of groundwater/surface water and replenishment of imported water supplies in the basin and determines the amount that can be safely extracted. The Watermaster coordinates imported water deliveries and recharge. Watermaster coordinates local involvement in efforts to preserve and restore the quality of groundwater in the basin. The Watermaster assists and encourages regulatory agencies to enforce water quality regulations affecting the basin; collects production, water quality, and other relevant data from producers; prepares an annual report of pumping and diversions; and a Five Year Plan to address water quality management.

The Main San Gabriel Basin Judgment allows a producer to pump or divert more water than its share, but the producer must pay for replenishment water for any amount produced above its water rights. Producers can carryover up to 100 percent of their water rights for only one year.

Any entity, public or private, desiring to spread and store supplemental water within the basin for subsequent recovery and use for Watermaster credit must have a cyclic storage agreement

pursuant to Watermaster’s Rules and Regulations. Cyclic storage agreements are for a term of five years and may extend for additional terms, not to exceed five years. The cyclic storage agreement notes the maximum amount of supplemental water that may be stored at any point in time by a particular storing entity.

**Table 7-2  
Summary of Management Agencies in the Main San Gabriel and Puente Basins**

<b>Agency</b>	<b>Role</b>
<b>Main San Gabriel Basin</b>	
Main San Gabriel Basin Watermaster	Court appointed Watermaster to manage water quantity/quality; coordinate U.S. EPA Operable Unit cleanup.
Upper San Gabriel Valley Municipal Water District	Delivery of Supplemental Water
Three Valleys Municipal Water District	Delivery of Supplemental Water
San Gabriel Valley Municipal Water District	Delivery of Supplemental Water
County of Los Angeles, Department of Public Works (LACDPW)	Recharge local runoff/supplemental water
San Gabriel Basin Water Quality Authority	Obtain funding for Basin clean up activities
San Gabriel River Watermaster	Calculates credits/debits between Main San Gabriel Basin and Central Basin
<b>Puente Basin</b>	
Puente Basin Watermaster	Appointed by the Principal Parties to the Judgment to determine the annual Operating Safe Yield and Annual Pumping Rights and components.
Puente Narrows Watermaster	Calculates credits/debits between Puente Basin and Main Basin.
Los Angeles County Department of Public Works	Monitors water levels in Puente Basin
Los Angeles Regional Water Quality Control Board	Oversees clean-up in Puente Basin of groundwater contamination
U.S. Environmental Protection Agency	Oversees remediation of Puente Valley Operable Unit component of the San Gabriel Valley Superfund Site.
Three Valleys Municipal Water District	Delivery of supplemental imported water
County Sanitation Districts of Los Angeles County	Provider of recycled water for landscape irrigation.
Walnut Valley Water District Rowland Water District	Puente Basin water quality sampling since 1992

### **Puente Basin**

The Puente Basin was adjudicated in 1986. Under the Judgment, a management plan was executed by the Principal Parties to the Judgment and is administered by a three-person Watermaster. The three Watermasters are nominated and appointed by the Principal Parties according to directives of the Judgment. The Judgment specifies the duties of the Watermaster to include determining Operating Safe Yield and notifying the Court and Principal Parties of Annual Pumping Rights and components thereof. Import return flow credits are calculated separately from Operating Safe Yield. The Judgment provides for up to 100 percent carryover of unpumped water rights for one year, up to 10 percent excess pumping, restricts exportation of groundwater, and makes no provisions for storage of surplus supplies within the groundwater basin.

### **Interactions with Adjoining Basins**

The Long Beach Judgment (City of Long Beach v. San Gabriel Valley Water Company) guarantees the Lower Area (Central and West Coast Basin) an average annual water supply of approximately 98,000 AFY through Whittier Narrows and is administered by the three-person court appointed San Gabriel River Watermaster. As part of that Judgment, subsurface flow from the Main San Gabriel Basin into Central Basin is calculated and is included in the determination of usable water provided to Lower Area.

Subsurface outflow from the Puente Basin into the Main San Gabriel Basin is governed and calculated pursuant to the provisions of the Puente Narrows Agreement between Puente Basin Water Agency (comprised of Walnut Valley Water District and Rowland Water District) and Upper San Gabriel Valley Municipal Water District. The Puente Narrows Agreement is Exhibit F to the Puente Basin Judgment. The Agreement calls for an average Base Underflow of 580 acre-feet per year from Puente Basin to the Main San Gabriel Basin, with credits and debits accumulating. Credit is also given to the Puente Basin Water Agency for pumping associated with some water quality clean-up operations pursuant to the Clean-Up Production Agreement that discharge treated water to the concrete-lined San Jose Creek.

### **WATER SUPPLY FACILITIES AND OPERATIONS**

The following provides a summary of the facilities within the Main San Gabriel and Puente basins. Key storage and extraction facilities include more than 300 production wells and associated facilities and 17 spreading basins for groundwater recharge.



**Municipal Production Wells**

**Table 7-3** provides a summary of the production wells in the Main San Gabriel and Puente basins.

**Main San Gabriel Basin**

In the Main San Gabriel Basin, there are 305 wells in the basin (250 active wells and 55 inactive wells). About 10 of these wells (less than 3 percent) are projected to be replaced or rehabilitated in the next 5 years (Stetson, 2006). Historical production in the Main San Gabriel Basin is summarized in **Figure 7-4**. Between fiscal years 1985/86 and 2004/05, production ranged from about 224,000 AFY to 283,000 AFY with an average of 255,525 AFY. The groundwater production exceeded the operating yield, which has ranged from 140,000 AFY to 240,000 AFY during the same period. Therefore, producers must provide for replacement water.

**Table 7-3**  
**Summary of Production Wells in the Main San Gabriel and Puente Basins**

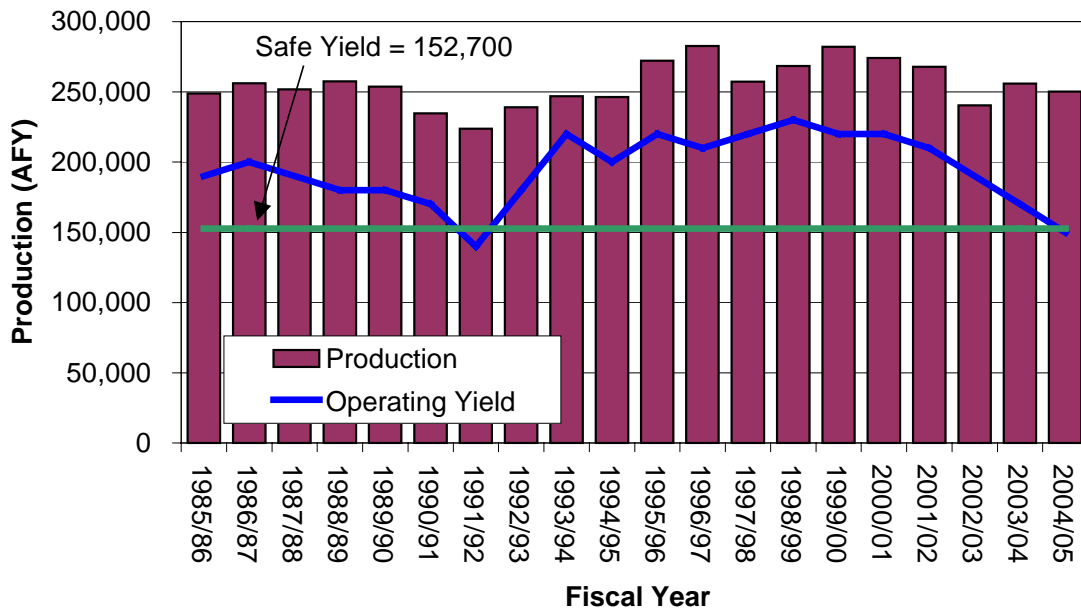
Category	Number of Wells	Estimated Production Capacity (AFY)	Average Production 1985-2004 (AFY)	Well Operation Cost (\$/AF)
<b>Main San Gabriel Basin</b>				
Municipal	250	~500,000 AFY (active wells) <sup>1</sup> ~80,000 AFY (inactive wells)	255,525	\$85 Power \$1.74 Disinfection \$2.50 O&M <b>Total</b> <sup>2</sup> <b>\$89.24</b>
Other	55			
<b>Total Main San Gabriel Basin</b>	<b>305</b>			
<b>Puente Basin</b> Non-potable-supply	<b>5</b>	300 to 600 gpm	905	

Notes: 1 Stetson, 2006  
2 Does not include treatment costs

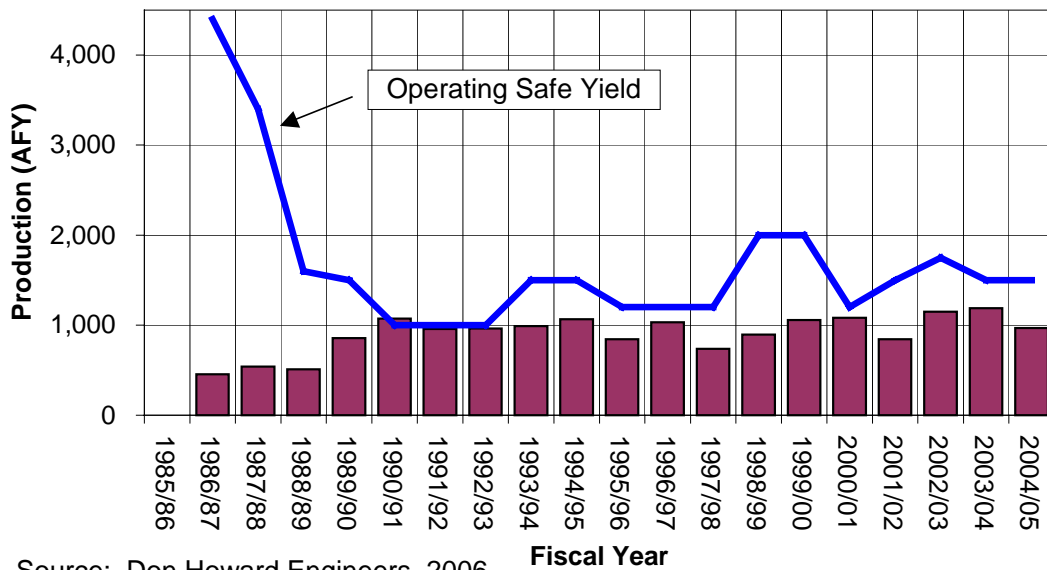
**Puente Basin**

There are five production wells in the Puente Basin. (Don Howard Engineers, December 2006). Due to the poor quality of the Puente Basin groundwater, groundwater is used for non-potable purposes including blending with reclaimed water, construction water, and irrigation (Puente Watermaster, April 2006). Historical production in the Puente Basin is shown in **Figure 7-5**.

**Figure 7-4**  
**Historical Groundwater Production in the Main San Gabriel Basin**



**Figure 7-5**  
**Historical Groundwater Production in the Puente Basin**



Source: Don Howard Engineers, 2006

**Other Production**

There are approximately 55 non-municipal wells in the Main San Gabriel Basin. Approximately 50 percent of the non-municipal production is for agricultural purposes and nearly 50 percent is for either industrial or domestic purposes (Stetson, 2006).

**ASR Wells**

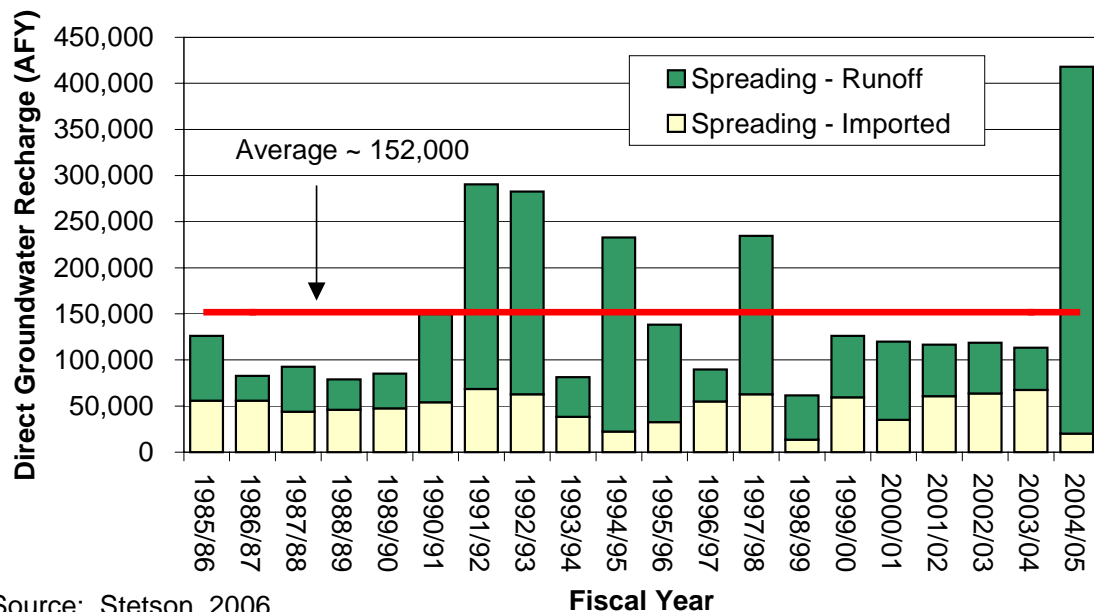
There are no ASR wells in the Main San Gabriel and Puente Basins.

**Spreading Basins**

**Main San Gabriel Basin**

There are currently 17 spreading basins, covering more than 1,100 acres, either operated by LACDPW or other agencies that are capable of capturing stormwater runoff from the adjacent canyons or imported water. The details of these facilities are summarized in **Table 7-4**. The historical recharge data are presented in **Figure 7-6**.

**Figure 7-6**  
**Historical Groundwater Recharge in the Main San Gabriel Basin**



Source: Stetson, 2006

LACDPW spreads imported water from Metropolitan and SGVMWD in the San Gabriel Valley on behalf of the SGVMWD, Upper San Gabriel Valley Municipal Water District, and the Three Valleys Municipal Water District. The spreading capacity of the existing facilities is more than 600,000 AFY. However, the amount of imported water that can be spread is limited because space in the basins must be reserved for the capture of runoff during storm events. Between fiscal years 1985/86 and 2004/05, from 62,000 and

417,000 AFY, with an average of approximately 152,000 AFY was recharged in the Main San Gabriel Basin.

**Table 7-4**  
**Summary of Spreading Basins in the Main San Gabriel Basin**

<b>Spreading Basin</b>	<b>Area (acres)</b>	<b>Wetted Area (acres)</b>	<b>Recharge Capacity (cfs)</b>	<b>Recharge Capacity (AFY)</b>	<b>Source Water</b>	<b>Owner</b>
Ben Lomond	24	17	30	21,681	Runoff	LACDPW
Big Dalton	24	8	12	8,672	Runoff	LACDPW
Buena Vista	10	6	6	4,336	Runoff	LACDPW
Citrus	19	15	28	20,236	Runoff	LACDPW
Eaton Basin	16	10	10	7,227	Runoff	LACDPW
Fish Canyon	6	4	7	5,059	Runoff	California-American Water Company
Forbes	21	10	5	3,614	Runoff Imported	LACDPW
Irwindale/Manning	62	30	60	43,362	Runoff Imported	LACDPW
Little Dalton	14	5	15	10,841	Runoff Imported	LACDPW
Peck Road	157	105	25	18,068	Runoff	LACDPW
San Dimas Canyon	22	11	12	8,672	Runoff	LACDPW
San Gabriel Canyon	165	140	50	36,135	Runoff Imported	LACDPW
San Gabriel River	196	196	180	130,086	Runoff Imported	LACDPW
Santa Fe	338	168	400	289,080	Runoff Imported	LACDPW
Sawpit	12	4	12	8,672	Runoff	LACDPW
Valley Rubber Dam	60	60	0	0	Runoff Imported	LACDPW
Walnut	16	8	5	3,614	Runoff	LACDPW
<b>Total</b>	<b>1162</b>	<b>797</b>	<b>857</b>	<b>619,355</b>		

Source: LACDPW, 2006

### **Puente Basin**

There are no spreading basins in Puente Basin.

### **Seawater Intrusion Barriers**

There are no seawater intrusion barriers in the Main San Gabriel and Puente Basins.

### **Desalters**

There are no desalters in the Main San Gabriel and Puente Basins.

## **GROUNDWATER LEVELS**

The following section provides a description of groundwater levels in the Main San Gabriel and Puente Basins.

### **Main San Gabriel Basin**

As shown in **Figure 7-7**, groundwater flow in the Main San Gabriel Basin is generally from the east to the west across the basin and southward into the Central Basin. In addition, groundwater typically flows northward from the Puente Basin into the Main San Gabriel Basin. Current groundwater levels range from about 1,200 feet MSL in the east portion of the basin along the San Gabriel Mountains to 110 feet MSL in the Alhambra area (referred to as the Alhambra pumping hole).

A key well located in Baldwin Park is used as an indicator of the amount of water in storage. As shown in **Figure 7-8**, the typical basin operating range is for basin water levels between 200 and 250 feet MSL. As discussed above, imported water cannot be spread when the key well groundwater level is above 250 feet. After reaching a historic low water level of 195.5 feet MSL in December 2004, water levels increased in the Baldwin Park key well to 251 feet MSL in June 2005. Water level in April 2006 was approximately 246 feet MSL.

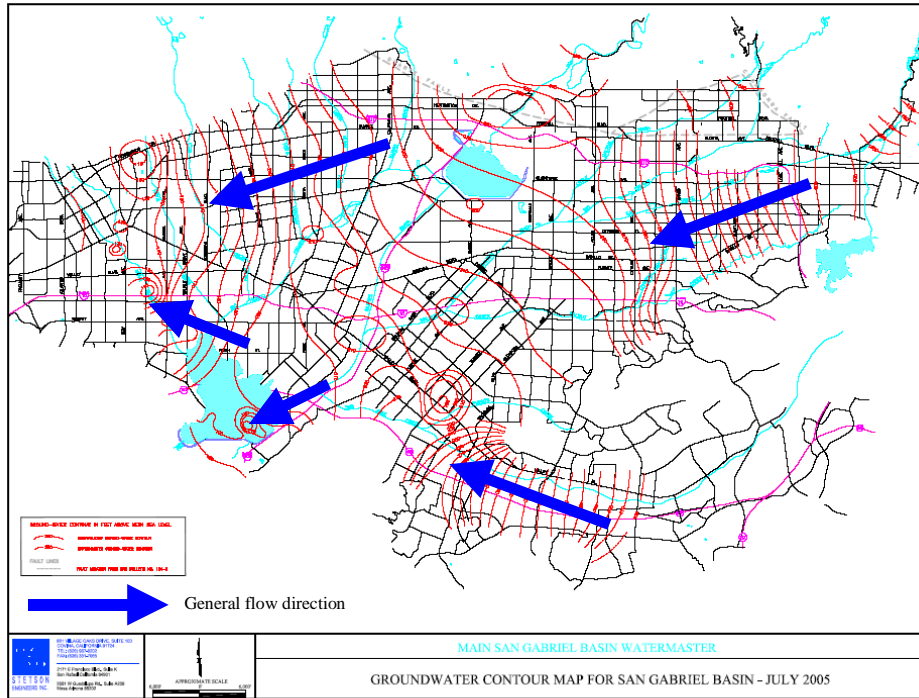
### **Puente Basin**

Groundwater movement within the Puente Basin is generally controlled by topographic highs (i.e. The surrounding hills). Faults that may potentially affect groundwater movement have not been identified within the Puente Basin (CH2MHill, 1997). Because the Puente Basin is constrained on the north and south by bedrock, groundwater generally flows toward the west and northwest. As shown in **Figure 7-9**, water levels have been relatively stable in the Puente Basin since 1985 with an overall fluctuation of less than 25 feet.

## **GROUNDWATER QUALITY**

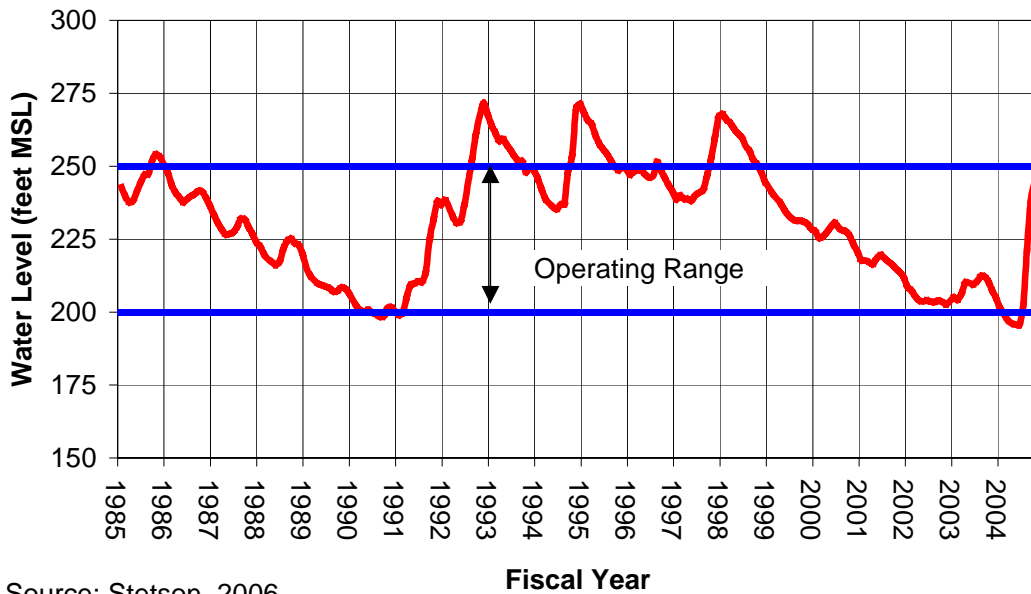
The following section provides a brief description of the groundwater quality issues in the Main San Gabriel and Puente Basins.

**Figure 7-7**  
**Groundwater Contour Map of the Main San Gabriel and Puente Basins – Summer 2005**



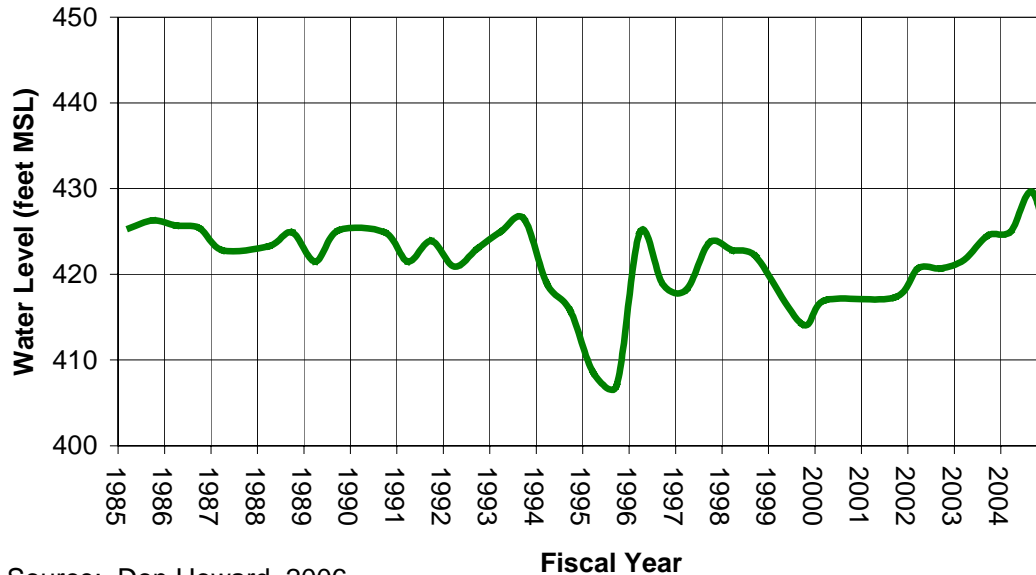
Source: Stetson, 2006

**Figure 7-8**  
**Historical Water Levels in the Main San Gabriel Basin**



Source: Stetson, 2006

**Figure 7-9**  
**Historical Water Levels in the Puente Basin**



Source: Don Howard, 2006

### **Groundwater Quality Monitoring**

The Main San Gabriel Basin Watermaster currently coordinates the Title 22 sampling of approximately 200 active wells in the basin. In addition, groundwater quality is monitored by Watermaster at least once per year for nitrate and volatile organic compounds (VOCs) as part of the Basinwide Ground Water Quality Monitoring Program. The project is designed to facilitate the coordination of existing monitoring done by other agencies under one comprehensive program.

In the Puente Basin, general water quality was monitored by the Los Angeles County Department of Public Works for 1986 and ending in 1992. Since then, water quality monitoring has been performed by Walnut Valley Water District and Rowland Water District. Walnut Valley Water District quarterly monitors and reports total dissolved solids (TDS) concentrations, and Rowland Water District analyzes for a wider range of water quality constituents. The data are reported in the Puente Basin Watermaster's annual report.

### **Groundwater Contaminants**

**Table 7-5** provides a summary of groundwater constituents of concern for Main San Gabriel and Puente Basins.

**Table 7-5**  
**Summary of Constituents of Concern in the Main San Gabriel and Puente Basins**

Constituent	Units	Range	Description
<b>TDS</b> Secondary MCL = 500	mg/L	Main Basin: 90 to 4,288 Average ~ 367	Main Basin: Data from municipal production wells indicate a range of 172 to 914 mg/L with an average of 318 mg/L.
		Puente Basin: 1,100	Puente Basin: as measured at Rowland Water District well.
<b>Nitrate (as N)</b> MCL = 10	mg/L	Main Basin: ND to 27.8	Main Basin: Exceed nitrate MCL in eastern portion of basin.
		Puente Basin: 8.44	Puente Basin: as sampled by Rowland Water District
<b>VOCs (TCE and PCE)</b> TCE MCL = 5 PCE MCL = 5	µg/L	Main Basin: ND to 499 for TCE ND to 330 for PCE	Main Basin: 64 wells are currently treated for a variety of VOCs associated with prior land use in the basin. Much of the basin is unaffected.
		Puente Basin: TCE: ND to 28 PCE: ND to 4.7	Puente Basin: To be addressed by Superfund cleanup of Puente Valley Operable Unit overseen by USEPA. Concentrations reported in remedial design progress report Aug 2006.
<b>Perchlorate</b> Notification level = 6	µg/L	Main Basin: ND to 183	Main Basin: In January 2002, 22 wells were removed from service due to unacceptable levels of perchlorate. Perchlorate treatment facilities are currently online.
		Puente Basin: ND	Puente Basin: as measured at Rowland WD well



**Table 7-5 (continued)**  
**Summary of Constituents of Concern in the Main San Gabriel and Puente Basins**

Constituent	Units	Range	Description
NDMA Notification level = 2	ppt	Main Basin: ND to > 2 ppt	Main Basin: During 1998, eight local wells were found to contain levels of NDMA above the action level of 2 ppt. Three facilities are currently in operation to treat NDMA.
		Puente Basin: ND	Puente Basin: as measured at Rowland WD well

Sources: Main San Gabriel Basin Watermaster, 2004 and DWR, 2004  
Puente Basin Watermaster, September, 2006.  
GeoTrans, Inc., August 10, 2006

### Main San Gabriel Basin

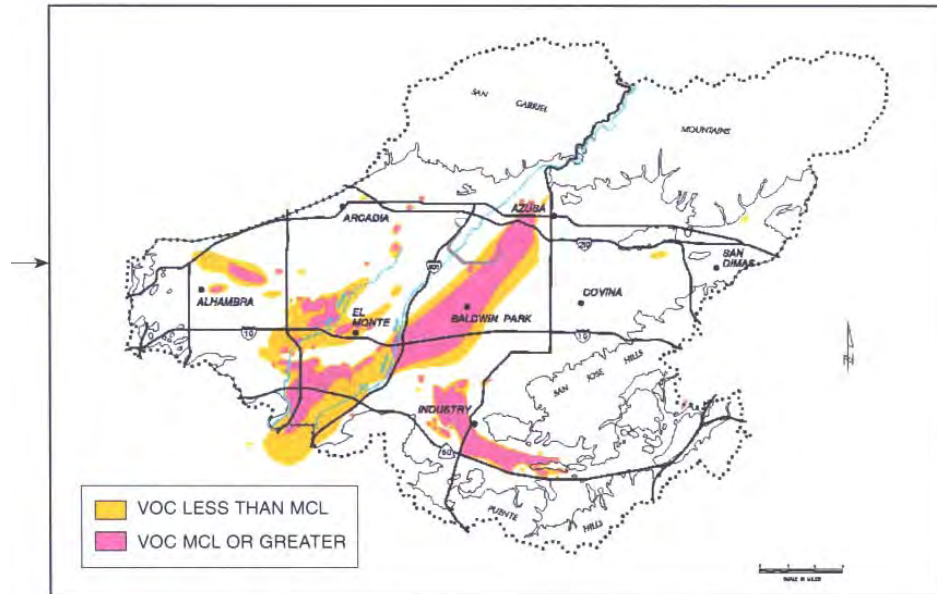
Water quality within the Main San Gabriel Basin is good in most areas. TDS concentrations range from 90 to 4,288 mg/L and average about 367 mg/L in the Main San Gabriel Basin (DWR, 2004). Concentrations in the Puente Basin average above 1,200 mg/L (DWR, 2004). Key constituents of concern for the Main San Gabriel Basin are summarized in **Table 7-5**. These constituents include: TDS, nitrate, VOCs, perchlorate and NDMA.

During the late 1970s and early 1980s, significant groundwater contamination associated with various VOCs was discovered in the Main San Gabriel Basin. The USEPA established Operable Units for areas within the basin that have been contaminated by VOCs and require groundwater cleanup (defined as Area 3, Whittier Narrows, Puente, Baldwin Park, El Monte and South El Monte Operable Units). Cleanup operations are currently underway in Whittier Narrows, Puente, Baldwin Park, El Monte and South El Monte Operable Units. A remedial investigation to identify the extent of contamination is currently underway in the Area 3 Operable Unit. VOC concentrations are shown in **Figure 7-10**.

Nitrate is also an issue for the Main San Gabriel Basin. As shown in **Figure 7-11**, nitrate concentrations exceed the nitrate MCL in eastern portion of basin. Water contaminated with nitrates is either blended with other sources or not used (Watermaster, 2004).

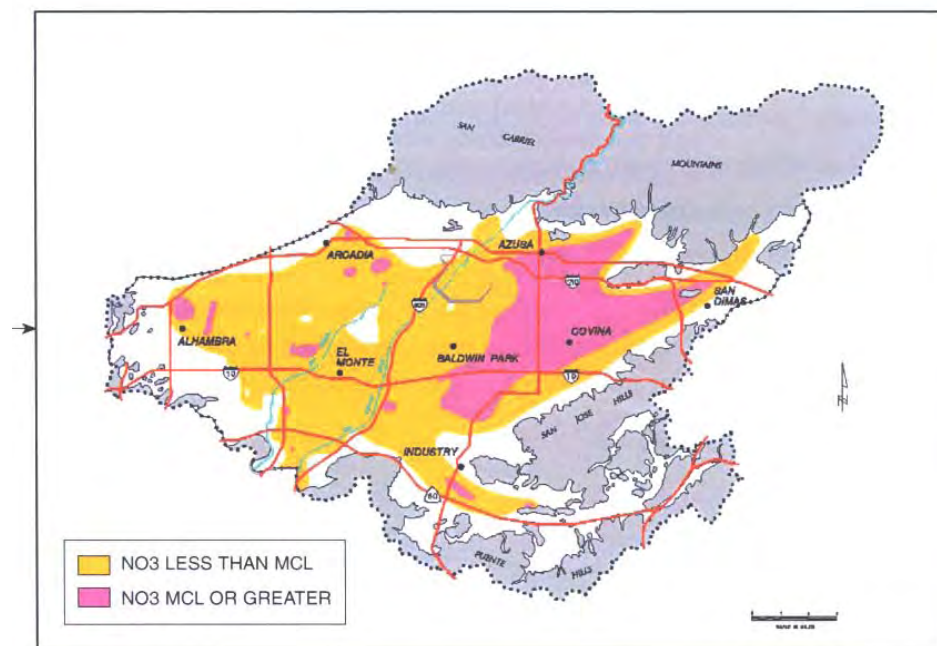
In addition to VOCs and nitrate, perchlorate and NDMA have been detected in concentrations above applicable notification levels in wells from the Main San Gabriel Basin. In January 2002, 22 wells were removed from service due to unacceptable levels of perchlorate. Perchlorate treatment facilities are currently online. During 1998, eight local wells were found to contain levels of NDMA above the action level of 2 ppt. Three facilities are currently in operation to treat NDMA.

**Figure 7-10**  
**Location of VOC Plumes in the Main San Gabriel and Puente Basins**



Source: Main San Gabriel Basin Watermaster, 2004

**Figure 7-11**  
**Location of Nitrate Plumes in the Main San Gabriel and Puente Basins**



Source: Main San Gabriel Basin Watermaster, 2004

## **Puente Basin**

The western portion of the Puente Basin in the vicinity of the Puente Narrows lies within the U.S. Environmental Protection Agency's Puente Valley Operable Unit of the San Gabriel Valley Superfund Site. The cleanup of the Puente Valley Operable Unit will involve cleanup of VOCs including TCE and PCE within the shallow groundwater. As of August 2006, remediation wells had been drilled and design of the remedial action was underway. Remediation of other VOC leaks in the Puente Basin are overseen by the Los Angeles Regional Water Quality Control Board.

## **Blending Needs**

As discussed above, many wells in the Main San Gabriel Basin are blended to meet nitrate standards. Due to the high TDS of Puente Basin groundwater, Puente Basin groundwater is blended with recycled water to allow its use for landscape irrigation.

## **Groundwater Treatment**

The following section describes groundwater treatment activities in the Main San Gabriel basin. As shown in Table 7-6, about 93 wells are currently treated for VOCs, perchlorate or NDMA with a total treatment volume of about 79,000 AFY (about 30 percent of the total produced groundwater). Nearly 490,000 AF has been treated for VOCs as part of the USEPA cleanup since 1984 (Watermaster, 2005a).

## **EXISTING GROUNDWATER STORAGE PROGRAMS**

In the Main San Gabriel Basin, three current cyclic storage accounts (Metropolitan Water District on behalf of its member agencies and San Gabriel Valley Municipal Water District), totaling 180,000 AF of potential water storage capacity are maintained for providing supplemental water to the basin. These accounts allow delivery of imported water when it is available and the water is stored in the basin for sale to Watermaster at a later date. Metropolitan pre-delivers replenishment water to Main San Gabriel Basin. Metropolitan later sells stored water to Three Valleys Municipal Water District and Upper District at replenishment rate. The cyclic storage balance at the end of fiscal year 2004/05 was approximately 91,000 AF (Watermaster, 2005a).

There are no existing storage programs in the Puente Basin.

## **BASIN MANAGEMENT CONSIDERATIONS**

The following section identifies issues or considerations that are important for groundwater management in the Main San Gabriel and Puente Basins.

**Table 7-6  
 Summary of Groundwater Treatment in Main San Gabriel Basin**

<b>Treatment Type</b>	<b>Number of Wells</b>	<b>Constituents(s) of Concern</b>	<b>Treatment Target</b>	<b>Treatment Cost (\$/AF)</b>	<b>Amount Treated (AFY)</b>
Air Stripping	39	VOCs	ND	\$25	47,000
Liquid Phase GAC	16	VOCs	ND	Varies	14,000
Ultra-Violet/Oxidation	9	1,4-Dioxane	ND	\$100	6,000
Ion Exchange	17	Perchlorate	ND	\$200	6,000
Ultra-Violet	12	NDMA	ND	\$100	6,000
<b>Total</b>	<b>93</b>	<b>--</b>	<b>ND</b>	<b>--</b>	<b>79,000</b>

Source, Stetson, 2006.

### **Main San Gabriel Basin**

Storage and extraction in the Main San Gabriel Basin are limited by the following factors.

- Pumping subject to adjudication and limits the amount of water that could be produced.
- Cannot store supplemental imported water when the key well groundwater elevation exceeds 250 feet MSL. Water levels at this time are near or above the target level. Therefore, storage of supplemental water is currently limited.
- Must have a cyclic storage agreement with Watermaster to store supplemental imported water
- Perchlorate and various chlorinated solvent contaminants associated with the USEPA operable units may limit ability to store and extract water.
- Nitrate concentrations in eastern portion of the Basin may limit ability to store and extract water.

### **Puente Basin**

Storage and extraction in the Puente Basin are limited by the following factors.

- Pumping subject to adjudication and limits the amount of water that could be produced
- The Puente Basin Judgment does not provide for storage of surplus water supplies for later extraction.

**References:**

**Main San Gabriel Basin**

California State Superior Court for the County of Los Angeles (Long Beach Judgment), 1964. Case No. 722647, Board of Water Commissioners for the City of Long Beach et al. vs. San Gabriel Valley Water Company et al.

California State Superior Court for the County of Los Angeles (Main San Gabriel Judgment), 1989. Case No. 924127, Upper San Gabriel Valley Municipal Water District vs. City of Alhambra, et al.

Main San Gabriel Basin Watermaster, November 2004. Five-Year Water Quality and Supply Plan 2004-05 to 2008-09.

Main San Gabriel Basin Watermaster, 2005a. Annual Report 2004-05.

Main San Gabriel Basin Watermaster, 2005b. Determination of Operating Safe Yield for Fiscal Years 2005-06 through 2009-2010, May 24, 2005.

Main San Gabriel Watermaster, 2006a Website: <http://www.watermaster.org>. Accessed August 24, 2006.

Main San Gabriel Watermaster, 2006b Website: <http://www.watermaster.org/basinmap.html> Accessed August 24, 2006. (basin description and storage capacity).

State of California Department of Water Resources (DWR), 2004. Bulletin 118 – Main San Gabriel Valley Basin. Updated 2/27/04. Accessed at: [http://www.dpla2.water.ca.gov/publications/groundwater/bulletin118/basins/pdfs\\_desc/4-13.pdf#search=%22main%20san%20gabriel%20basin%2Cbulletin%20118%22](http://www.dpla2.water.ca.gov/publications/groundwater/bulletin118/basins/pdfs_desc/4-13.pdf#search=%22main%20san%20gabriel%20basin%2Cbulletin%20118%22)

Stetson Engineers, 2005. Upper San Gabriel Valley Municipal Water District Urban Water Management Plan. December 2005. Prepared for the Upper San Gabriel Valley Municipal Water District.

Stetson Engineers, 2006. Groundwater Study Questionnaire, groundwater production and groundwater level data.

**Puente Basin**

CH2MHill, 1997. Puente Valley Operable Unit Interim RI/FS Feasibility Study. Prepared for U.S. EPA. May 1997.

Ecological Systems Corporation, 1975. Pomona Valley Water Quality Management Study – Hydrogeology, Nitrates and Dissolved Solids. Prepared for Pomona Valley Municipal Water District.

Geotechnical Consultants, Inc., 1979. Hydrogeologic Evaluation. Spadra and Puente Basins. Step I – Facilities Plan Water Reclamation Project for Pomona Valley Municipal Water District.

GeoTrans, Inc. Bimonthly Progress Report, Shallow Zone Interim Remedial Design/Remedial Action, Puente Valley Operable Unit, Los Angeles County, California. August 10, 2006.

Puente Basin Judgment, 1986.

Puente Basin Watermaster, April 2006. 2006-2007 Final Operating Safe Yield Determination.

Puente Basin Watermaster, September, 2006. Twentieth Annual Report Fiscal Year 2005-2006.

# Analysis of the Energy Intensity of Water Supplies for West Basin Municipal Water District

March, 2007

Robert C. Wilkinson, Ph.D.

## Note to Readers

This report for West Basin Municipal Water District is an update and revision of an analysis and report by Robert Wilkinson, Fawzi Karajeh, and Julie Mottin (Hannah) conducted in April 2005. The earlier report, *Water Sources "Powering" Southern California: Imported Water, Recycled Water, Ground Water, and Desalinated Water*, was undertaken with support from the California Department of Water Resources, and it examined the energy intensity of water supply sources for both West Basin and Central Basin Municipal Water Districts. This analysis focuses exclusively on West Basin, and it includes new data for ocean desalination based on new engineering developments that have occurred over the past year and a half.

### Principal Investigator: Robert C. Wilkinson, Ph.D.

Dr. Wilkinson is Director of the Water Policy Program at the Donald Bren School of Environmental Science and Management, and Lecturer in the Environmental Studies Program, at the University of California, Santa Barbara. His teaching, research, and consulting focuses on water policy, climate change, and environmental policy issues. Dr. Wilkinson advises private sector entities and government agencies in the U.S. and internationally. He currently served on the public advisory committee for California's 2005 State Water Plan, and he represented the University of California on the Governor's Task Force on Desalination.

Contact: [wilkinson@es.ucsb.edu](mailto:wilkinson@es.ucsb.edu)



## West Basin Municipal Water District

**Contact:** Richard Nagel, General Manager  
West Basin Municipal Water District  
17140 South Avalon Boulevard, Suite 210  
Carson, CA 90746  
(310) 217 2411 phone, (310) 217-2414 fax  
[richn@westbasin.org](mailto:richn@westbasin.org)

West Basin Municipal Water District [www.westbasin.org](http://www.westbasin.org)



## Overview

Southern California relies on imported and local water supplies for both potable and non-potable uses. Imported water travels great distances and over significant elevation gains through both the California State Water Project (SWP) and Colorado River Aqueduct (CRA) before arriving in Southern California, consuming a large amount of energy in the process. Local sources of water often require less energy to provide a sustainable supply of water. Three water source alternatives which are found or produced locally and could reduce the amount of imported water are desalinated ocean water, groundwater, and recycled water. Groundwater and recycled water are significantly less energy intensive than imports, while ocean desalination is getting close to the energy intensity of imports.

Energy requirements vary considerably between these four water sources. All water sources require pumping, treatment, and distribution. Differences in energy requirements arise from the varying processes needed to produce water to meet appropriate standards. This study examines the energy needed to complete each process for the waters supplied by West Basin Municipal Water District (West Basin).

Specific elements of energy inputs examined in this study for each water source are as follows:

- Energy required to **import water** includes three processes: pumping California SWP and CRA supplies to water providers; treating water to applicable standards; and distributing it to customers.
- **Desalination of ocean water** includes three basic processes: 1) pumping water from the ocean or intermediate source (e.g. a powerplant) to the desalination plant; 2) pre-treating and then desalting water including discharge of concentrate; and 3) distributing water from the desalination plant to customers.
- **Groundwater** usage requires energy for three processes: pumping groundwater from local aquifers to treatment facilities; treating water to applicable standards; and distributing water from the treatment plant to customers. Additional injection energy is sometimes needed for groundwater replenishment.
- Energy required to **recycle water** includes three processes: pumping water from secondary treatment plants to tertiary treatment plants; tertiary treatment of the water, and distributing water from the treatment plant to customers.

The energy intensity results of this study are summarized in the table on the following page. They indicate that recycled water is among the least energy-intensive supply options available, followed by groundwater that is naturally recharged and recharged with recycled water. Imported water and ocean desalination are the most energy intensive water supply options in California. East Branch State Water Project water is close in energy intensity to desalination figures based on current technology, and at some points along the system, SWP supplies exceed estimated ocean desalination energy intensity. The following table identifies energy inputs to each of the water supplies including estimated energy requirements for desalination. Details describing the West Basin system operations are included in the water source sections. Note that the Title 22 recycled water energy figure reflects only the *marginal* energy required to treat secondary effluent wastewater which has been processed to meet legal discharge requirements, along with the energy to convey it to user.

### Energy Intensity of Water Supplies for West Basin Municipal Water District

	af/yr	Percentage of Total Source Type	kWh/af Conveyance Pumping	kWh/af MWD Treatment	kWh/af Recycled Treatment	kWh/af Groundwater Pumping	kWh/af Groundwater Treatment	kWh/af Desalination	kWh/af WBMWD Distribution	Total kWh/af	Total kWh/year
<b>Imported Deliveries</b>											
State Water Project (SWP) <sup>1</sup>	57,559	43%	3,000	44	NA	NA	NA	NA	0	3,044	175,209,596
Colorado River Aqueduct (CRA) <sup>1</sup> (other than replenishment water)	76,300	57%	2,000	44	NA	NA	NA	NA	0	2,044	155,957,200
<b>Groundwater<sup>2</sup></b>											
natural recharge	19,720	40%	NA	NA	NA	350	0	NA	0	350	6,902,030
replenished with (injected) SWP water <sup>1</sup>	9,367	19%	3,000	44	NA	350	0	NA	0	3,394	31,791,598
replenished with (injected) CRA water <sup>1</sup>	11,831	24%	2,000	44	NA	350	0	NA	0	2,394	28,323,432
replenished with (injected) recycled water	8,381	17%	205	0	790	350	0	NA	220	1,565	13,116,278
<b>Recycled Water</b>											
West Basin Treatment, Title 22	21,506	60%	205	NA	0	NA	NA	NA	285	490	10,537,940
West Basin Treatment, RO	14,337	40%	205	NA	790	NA	NA	NA	285	1,280	18,351,360
	<b>35,843</b>										
<b>Ocean Desalination</b>	20,000	100%	200	NA	NA	NA	NA	3,027	460	3,687	82,588,800

Notes:

NA Not applicable

<sup>1</sup> Imported water based on percentage of CRA and SWP water MWD received, averaged over an 11-year period. Note that the figures for imports do not include an accounting for system losses due to evaporation and other factors. These losses clearly exist, and an estimate of 5% or more may be reasonable. The figures for imports above should therefore be understood to be conservative (that is, the actual energy intensity is in fact higher for imported supplies than indicated by the figures).

<sup>2</sup> Groundwater values include entire basin, West Basin service area covers approximately 86% of the basin. Groundwater values are specific to aquifer characteristics, including depth, within the basin.

## Energy Intensity of Water

Water treatment and delivery systems in California, including extraction of “raw water” supplies from natural sources, conveyance, treatment and distribution, end-use, and wastewater collection and treatment, account for one of the largest energy uses in the state.<sup>1</sup> The California Energy Commission estimated in its 2005 Integrated Energy Policy Report that approximately 19% of California’s electricity is used for water related purposes including delivery, end-uses, and wastewater treatment.<sup>2</sup> The total energy embodied in a unit of water (that is, the amount of energy required to transport, treat, and process a given amount of water) varies with location, source, and use within the state. In many areas, the energy intensity may increase in the future due to limits on water resource extraction, and regulatory requirements for water quality, and other factors.<sup>3</sup> Technology improvements may offset this trend to some extent.

*Energy intensity* is the total amount of energy, calculated on a whole-system basis, required for the use of a given amount of water in a specific location.

### The Water-Energy Nexus

Water and energy systems are interconnected in several important ways in California. Water systems both provide energy – through hydropower – and consume large amounts of energy, mainly through pumping. Critical elements of California’s water infrastructure are highly energy-intensive. Moving large quantities of water long distances and over significant elevation gains, treating and distributing it within the state’s communities and rural areas, using it for various purposes, and treating the resulting wastewater, accounts for one of the largest uses of electrical energy in the state.<sup>4</sup>

Improving the efficiency with which water is used provides an important opportunity to increase related energy efficiency. (“*Efficiency*” as used here describes the useful work or service provided by a given amount of water.) Significant potential economic as well as environmental benefits can be cost-effectively achieved in the energy sector through efficiency improvements in the state’s water systems and through shifting to less energy intensive local sources. The California Public Utilities Commission is currently planning to include water efficiency improvements as a means of achieving energy efficiency benefits for the state.<sup>5</sup>

### Overview of Energy Inputs to Water Systems

There are four principle energy elements in water systems:

1. primary water extraction and supply delivery (imported and local)
2. treatment and distribution within service areas
3. on-site water pumping, treatment, and thermal inputs (heating and cooling)

#### 4. wastewater collection, treatment, and discharge

Pumping water in each of these four stages is energy-intensive. Other important components of embedded energy in water include groundwater pumping, treatment and pressurization of water supply systems, treatment and thermal energy (heating and cooling) applications at the point of end-use, and wastewater pumping and treatment.<sup>6</sup>

##### **1. Primary water extraction and supply delivery**

Moving water from near sea-level in the Sacramento-San Joaquin Delta to the San Joaquin-Tulare Lake Basin, the Central Coast, and Southern California, and from the Colorado River to metropolitan Southern California, is highly energy intensive.

Approximately 3,236 kWh is required to pump one acre-foot of SWP water to the end of the East Branch in Southern California, and 2,580 kWh for the West Branch. About 2,000 kWh is required to pump one acre foot of water through the CRA to southern California.<sup>7</sup> Groundwater pumping also requires significant amounts of energy depending on the depth of the source. (Data on groundwater is incomplete and difficult to obtain because California does not systematically manage groundwater resources.)

##### **2. Treatment and distribution within service areas**

Within local service areas, water is treated, pumped, and pressurized for distribution. Local conditions and sources determine both the treatment requirements and the energy required for pumping and pressurization.

##### **3. On-site water pumping, treatment, and thermal inputs**

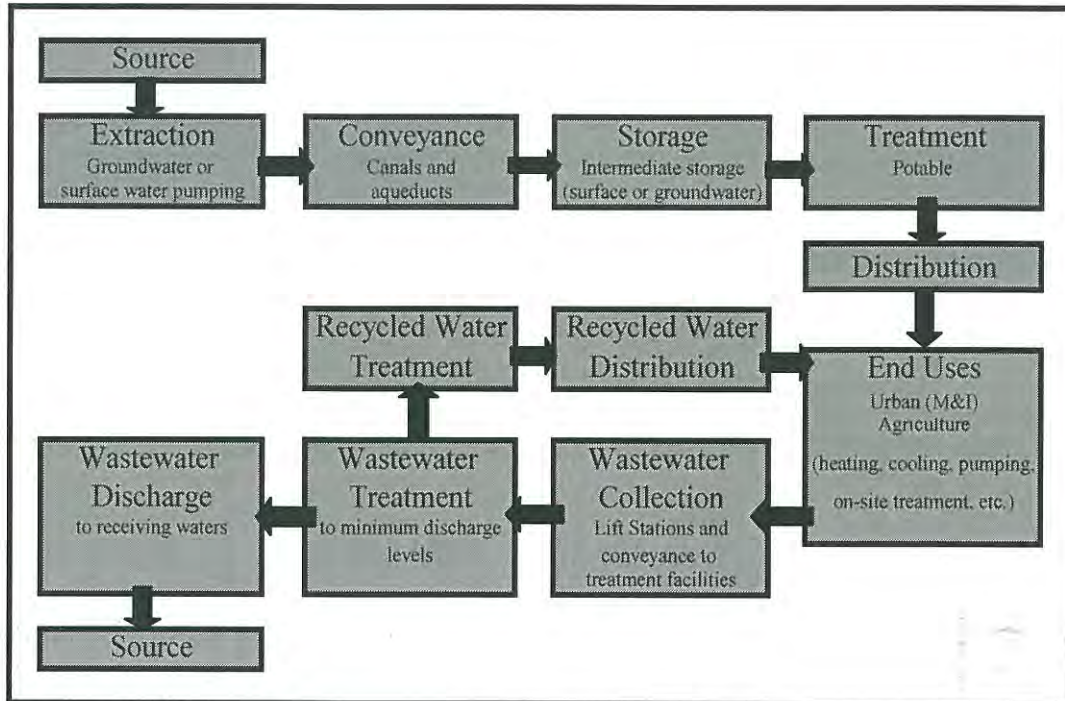
Individual water users use energy to further treat water supplies (e.g. softeners, filters, etc.), circulate and pressurize water supplies (e.g. building circulation pumps), and heat and cool water for various purposes.

##### **4. Wastewater collection, treatment, and discharge**

Finally, wastewater is collected and treated by a wastewater authority (unless a septic system or other alternative is being used). Wastewater is often pumped to treatment facilities where gravity flow is not possible, and standard treatment processes require energy for pumping, aeration, and other processes. (In cases where water is reclaimed and re-used, the calculation of total energy intensity is adjusted to account for wastewater as a *source* of water supply. The energy intensity generally includes the additional energy for treatment processes beyond the level required for wastewater discharge, plus distribution.)

The simplified flow chart below illustrates the steps in the water system process. A spreadsheet computer model is available to allow cumulative calculations of the energy inputs embedded at each stage of the process. This methodology is consistent with that applied by the California Energy Commission in its analysis of the energy intensity of water.

## Simplified Flow Diagram of Energy Inputs to Water Systems



Source: Robert Wilkinson, UCSB<sup>8</sup>

### Calculating Energy Intensity

Total energy intensity, or the amount of energy required to facilitate the use of a given amount of water in a specific location, may be calculated by accounting for the summing the energy requirements for the following factors:

- imported supplies
- local supplies
- regional distribution
- treatment
- local distribution
- on-site thermal (heating or cooling)
- on-site pumping
- wastewater collection
- wastewater treatment

Water pumping, and specifically the long-distance transport of water in conveyance systems, is a major element of California's total demand for electricity as noted above. Water use (based on embedded energy) is the next largest consumer of electricity in a typical Southern California home after refrigerators and air conditioners. Electricity required to support water service in the typical home in Southern California is estimated at between 14% to 19% of total residential energy demand.<sup>9</sup> If air conditioning is not a factor the figure is even higher. Nearly three quarters of this energy demand is for pumping imported water.

### **Interbasin Transfers**

Some of California's water systems are uniquely energy-intensive, relative to national averages, due to the pumping requirements of major conveyance systems which move large volumes of water long distances and over thousands of feet in elevation lift. Some of the interbasin transfer systems (systems that move water from one watershed to another) are net energy producers, such as the San Francisco and Los Angeles aqueducts. Others, such as the SWP and the CRA require large amounts of electrical energy to convey water. On *average*, approximately 3,000 kWh is necessary to pump one AF of SWP water to southern California,<sup>10</sup> and 2,000 kWh is required to pump one AF of water through the CRA to southern California.<sup>11</sup>

Total energy savings for reducing the full embedded energy of *marginal* (e.g. imported) supplies of water used indoors in Southern California is estimated at about 3,500 kWh/af.<sup>12</sup> Conveyance over long distances and over mountain ranges accounts for this high marginal energy intensity. In addition to avoiding the energy and other costs of pumping additional water supplies, there are environmental benefits through reduced extractions from stressed ecosystems such as the delta.

## **Imported Water: The State Water Project and the Colorado River Aqueduct**

Water diversion, conveyance, and storage systems developed in California in the 20<sup>th</sup> century are remarkable engineering accomplishments. These water works move millions of AF of water around the state annually. The state's 1,200-plus reservoirs have a total storage capacity of more than 42.7 million acre feet (maf).<sup>13</sup> West Basin receives imported water from Northern California through the State Water Project and Colorado River water via the Colorado River Aqueduct. The Metropolitan Water District of Southern California delivers both of these imported water supplies to the West Basin.

## California's Major Interbasin Water Projects



### The State Water Project

The State Water Project (SWP) is a state-owned system. It was built and is managed by the California Department of Water Resources (DWR). The SWP provides supplemental water for agricultural and urban uses.<sup>14</sup> SWP facilities include 28 dams and reservoirs, 22 pumping and generating plants, and nearly 660 miles of aqueducts.<sup>15</sup> Lake Oroville on the Feather River, the project's largest storage facility, has a total capacity of about 3.5 maf.<sup>16</sup> Oroville Dam is the tallest and one of the largest earth-fill dams in the United States.<sup>17</sup>

Water is pumped out of the delta for the SWP at two locations. In the northern Delta, Barker Slough Pumping Plant diverts water for delivery to Napa and Solano counties through the North Bay

Aqueduct.<sup>18</sup> Further south at the Clifton Court Forebay, water is pumped into Bethany Reservoir by the Banks Pumping Plant. From Bethany Reservoir, the majority of the water is conveyed south in the 444-mile-long Governor Edmund G. Brown California Aqueduct to agricultural users in the San Joaquin Valley and to urban users in Southern California. The South Bay Pumping Plant also lifts water from the Bethany Reservoir into the South Bay Aqueduct.<sup>19</sup>

The State Water Project is the largest consumer of electrical energy in the state, requiring an average of 5,000 GWh per year.<sup>20</sup> The energy required to operate the SWP is provided by a combination of DWR's own hydroelectric and other generation plants and power purchased from other utilities. The project's eight hydroelectric power plants, including three pumping-generating plants, and a coal-fired plant produce enough electricity in a normal year to supply about two-thirds of the project's necessary power.

Energy requirements would be considerably higher if the SWP was delivering full contract volumes of water. The project delivered an average of approximately 2.0 mafy, or half its contracted volumes, throughout the 1980s and 1990s.<sup>21</sup> Since 2000 the volumes of imported water have generally increased.

The following map indicates the location of the pumping and power generation facilities on the SWP.

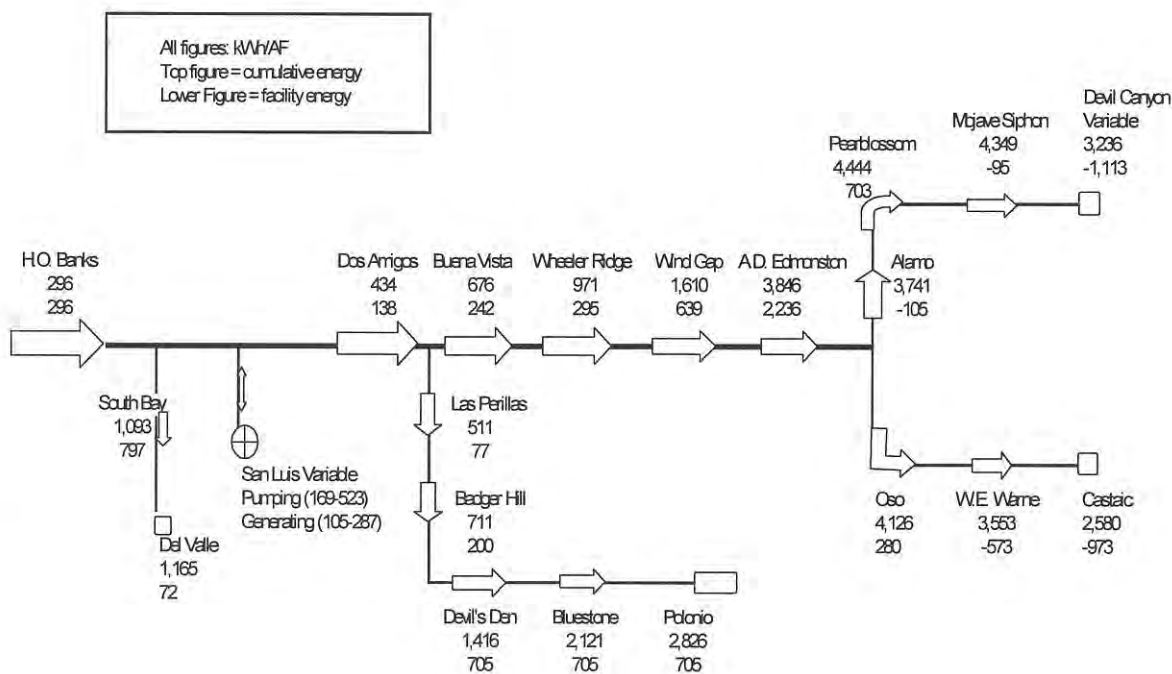


## Names and Locations of Primary State Water Delivery Facilities



The following schematic shows each individual pumping unit on the State Water Project, along with data for both the individual and cumulative energy required to deliver an AF of water to that point in the system. Note that the figures include energy recovery in the system, but they do not account for losses due to evaporation and other factors. These losses may be in the range of 5% or more. While more study of this issue is in order, it is important to observe that the energy intensity numbers are conservative (e.g. low) in that they assume that all of the water originally pumped from the delta reaches the ends of the system without loss.

### State Water Project Kilowatt-Hours per Acre Foot Pumped (Includes Transmission Losses)



Source: Wilkinson, based on data from: California Department of Water Resources, State Water Project Analysis Office, Division of Operations and Maintenance, *Bulletin 132-97*, 4/25/97.

## The Colorado River Aqueduct

Significant volumes of water are imported to the Los Angeles Basin and San Diego in Southern California from the Colorado River via the Colorado River Aqueduct (CRA). The aqueduct was built by the Metropolitan Water District of Southern California (MWD). Though MWD's allotment of the Colorado River water is 550,000 afy, it has historically extracted as much as 1.3 mafy through a combination of waste reduction arrangements with Imperial Irrigation District (IID) (adding about 106,000 afy) and by using "surplus" water.<sup>22</sup> The Colorado River water supplies require about 2,000 kWh/af for conveyance to the Los Angeles basin.

The Colorado River Aqueduct extends 242 miles from Lake Havasu on the Colorado River to its terminal reservoir, Lake Mathews, near Riverside. The CRA was completed in 1941 and expanded in 1961 to a capacity of more than 1 MAF per year. Five pumping plants lift the water 1,616 feet, over several mountain ranges, to southern California. To pump an average of 1.2 maf of water per year into the Los Angeles basin requires approximately 2,400 GWh of energy for the CRA's five pumping plants.<sup>23</sup> On average, the energy required to import Colorado River water is about 2,000 kWh/AF. The aqueduct was designed to carry a flow of 1,605 cfs (with the capacity for an additional 15%).

The sequence for CRA pumping is as follows: The Whitsett Pumping Plant elevates water from Lake Havasu 291 feet out of the Colorado River basin. At "mile 2," Gene pumping plant elevates water 303 feet to Iron Mountain pumping plant at mile 69, which then boosts the water another 144 feet. The last two pumping plants provide the highest lifts - Eagle Mountain, at mile 110, lifts the water 438 feet, and Hinds Pumping Plant, located at mile 126, lifts the water 441 feet.<sup>24</sup>

MWD has recently improved the system's energy efficiency. The average energy requirement for the CRA was reduced from approximately 2,100 kWh /af to about 2,000 kWh /af "through the increase in unit efficiencies provided through an energy efficiency program." The energy required to pump each acre foot of water through the CRA is essentially constant, regardless of the total annual volume of water pumped. This is due to the 8-pump design at each pumping plant. The average pumping energy efficiency does not vary with the number of pumps operated, and MWD states that the same 2,000 kWh/af estimate is appropriate for both the "Maximum Delivery Case" and the "Minimum Delivery Case."<sup>25</sup>

It appears that there are limited opportunities to shift pumping off of peak times on the CRA. Due to the relatively steep grade of the CRA, limited active water storage, and transit times between plants, the system does not generally lend itself to shifting pumping loads from on-peak to off-peak. Under the Minimum Delivery Case, the reduced annual water deliveries would not necessarily bring a reduction in annual peak load, since an 8-pump flow may still need to be maintained in certain months.

Electricity to run the CRA pumps is provided by power from hydroelectric projects on the Colorado River as well as off-peak power purchased from a number of utilities. The Metropolitan Water District has contractual hydroelectric rights on the Colorado River to "more than 20 percent of the firm energy and contingent capacity of the Hoover power plant and 50 percent of the energy and capacity of the Parker power plant."<sup>26</sup> Energy purchased from utilities makes up approximately 25 percent of the remaining energy needed to power the Colorado River Aqueduct.<sup>27</sup>

## Minimizing the Need for Inter-Basin Transfers

For over 100 years, California has sought to transfer water from one watershed for use in another. The practice has caused a number of problems. As of 2001, California law requires that the state examine ways to “*minimize the need to import water from other hydrologic regions*” and report on these approaches in the official State Water Plan.<sup>28</sup> A new focus and priority has been placed on developing *local* water supply sources, including efficiency, reuse, recharge, and desalination. The law directs the Department of Water Resources as follows:<sup>29</sup>

The department, as a part of the preparation of the department's Bulletin 160-03, shall include in the California Water Plan a report on the development of regional and local water projects within each hydrologic region of the state, as described in the department's Bulletin 160-98, to improve water supplies to meet municipal, agricultural, and environmental water needs and *minimize the need to import water from other hydrologic regions*.

(Note that Bulletin 160-03 became Bulletin 160-05 due to a slip in the completion schedule.)

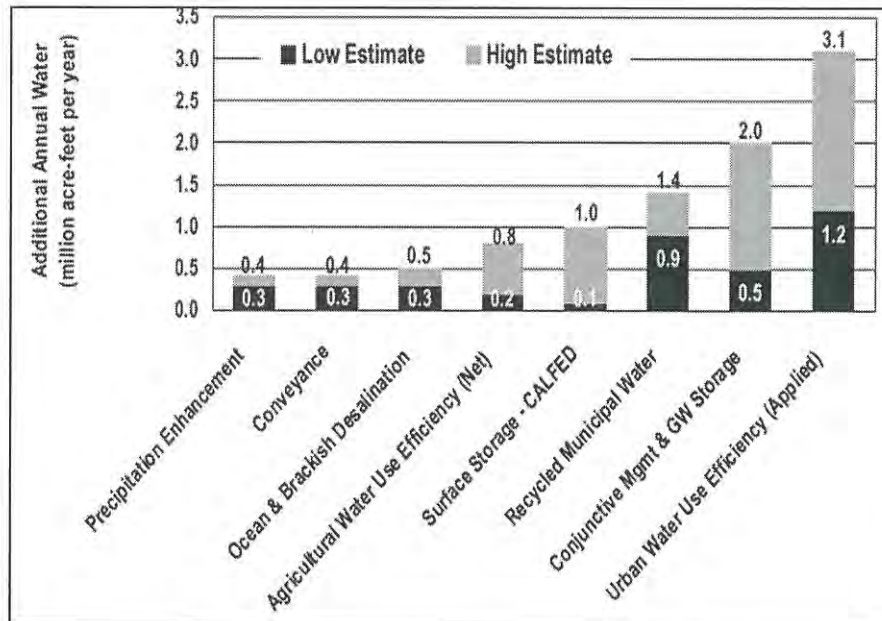
The legislation set forth the range of local supply options to be considered:

The report shall include, but is not limited to, regional and local water projects that use technologies for desalting brackish groundwater and ocean water, reclaiming water for use within the community generating the water to be reclaimed, the construction of improved potable water treatment facilities so that water from sources determined to be unsuitable can be used, and the construction of dual water systems and brine lines, particularly in connection with new developments and when replacing water piping in developed or redeveloped areas.

This law calls for a thorough consideration in the state's official water planning process of work that is already going on in various areas of the state. The significance of the legislation is that for the first time, local supply development is designated as a priority in order to minimize inter-basin transfers.

The Department of Water Resources State Water Plan (Bulletin 160-05) reflects this new direction for the state in its projection of water supply options for the next quarter century. The following graph clearly indicates the importance of local water supplies from various sources in the future.

**California State Water Plan 2005  
Water Management and Supply Options for the Next 25 Years**



Source: *California Water Plan Update 2005*.<sup>30</sup>

### **Energy Requirements for Treatment of State Water Project and the Colorado River Aqueduct Supplies**

Imported SWP and CRA supplies require an estimated 44 kWh/af for treatment before it enters the local distribution systems. Water pressure from MWD's system is sufficient to move supplies through the West Basin distribution system without requiring additional pressure.

### **Groundwater and Recycled Water at West Basin MWD**

Nearly half of the water used in the service area of the Metropolitan Water District of Southern California (from Ventura to Mexico) is secured from *local* sources, and the percentage of total supplies provided by local sources is growing steadily.<sup>31</sup> This figure is up from approximately one-third of the supply provided by local resources in the mid-1990s.<sup>32</sup> MWD has encouraged local supply development through support for recycling, groundwater recovery, conservation, groundwater storage, and most recently, ocean desalination.

Groundwater and recycled water are important and growing supply sources for West Basin. Water flows through natural hydrologic cycles continuously. The water we use today has made the journey many times. In water recycling programs, water is treated and re-used for various purposes including recharging groundwater aquifers. The treatment processes essentially short-circuit the longer-term process of natural evaporation and precipitation. In cities around the world water is used and then returned to natural water systems where it flows along to more users down stream. It is often used again and again before it flows to the ocean or to a terminal salt sink.

## **Groundwater at West Basin MWD**

Groundwater reservoirs in West Basin are replenished with four water sources; natural recharge, SWP supplies, CRA supplies, and recycled water supplies. The largest portion (approximately 40%) of groundwater supplies is derived from natural recharge. The energy associated with recovering this naturally recharged supply is estimated at 350 kWh/af for groundwater pumping.

Imported water, from both the SWP and CRA, is injected into the groundwater supply in West Basin. The imported water remains at sufficient pressure for injection, so no additional energy is required. The energy requirements for importing water are significant, however, primarily due to the energy associated with importing the water from northern California and the Colorado River. The imported water also passes through MWD's treatment plant, incurring additional energy requirements. The total energy intensity for West Basin's imported water used for recharge of groundwater storage from the SWP is 3,394 kWh/af and from the CRA is 2,394 kWh/af.

Recycled water is also used to recharge groundwater in the basin. West Basin replenishes groundwater by injecting RO treated recycled water from the West Basin Water Recycling Facility (WBWRF). The total energy use is 1,565 kWh/af. Details for the recycled water energy are described in the next section.

## **Recycled Water at West Basin MWD**

Many cities in California are using advanced processes and filtering technology to treat wastewater so it can be re-used for irrigation, industry, and other purposes. In response to increasing demands for water, limitations on imported water supplies, and the threat of drought, West Basin has developed state-of-the-art regional water recycling programs. Water is increasingly being used more than once within systems at both the end-use level and at the municipal level. This is because scarce water resources (and wastewater discharges) are increasing in cost and because cost-effective technologies and techniques for re-using water have been developed that meet health and safety requirements. At the end-use, water is recycled within processes such as cooling towers and industrial processes prior to entering the wastewater system. Once-through systems are increasingly being replaced by re-use technologies. At the municipal level, water re-use has become a significant source of supplies for both landscape irrigation and for commercial and industrial processes. MWD of Southern California is supporting 33 recycling programs in which treated wastewater is used for non-potable purposes.<sup>33</sup>

West Basin provides customers with recycled water used for municipal, commercial and industrial applications. Approximately 27,000 AF of recycled water is annually distributed to more than 210 sites in the South Bay. These sites use recycled water for a wide range of non-potable applications. Based in El Segundo, California, the WBWRF is among the largest projects of its kind in the nation, producing five qualities of recycled water with the capacity at full build-out to recycle 100,000 AF per year of wastewater from the Los Angeles Hyperion Treatment Plant.

In 1998, West Basin began to construct the nation's only regional high-purity water treatment facility, the Carson Regional Water Recycling Facility (CRWRF). A pipeline stretching through five South Bay communities connects the CRWRP to West Basin's El Segundo facility. At the CRWRF, West Basin ultra-purifies the recycled water it gets from the El Segundo facility. From the CRWRF, West Basin uses service lines to transport two types of purified water to the BP Refinery in Carson. The West Basin expansion also includes a new disposal pipeline to carry brine reject water from the CRWRF to a Los Angeles County Sanitation District's outfall.

In order to provide perspective on the energy requirements for the WBWRF, two water qualities and associated energy intensity are presented. "Title 22" water, produced by a gravity filter treatment system, requires conveyance pumping energy from Hyperion to WBWRF at 205 kWh/af. The water flows through the filters via gravity, thus no additional energy is required for treatment. The final energy requirement is 285 kWh/af for distribution with a total energy requirement of 490 kWh/af. This is the lowest grade of recycled water that WBWRF produces. Contrasting the Title 22 water, WBWRF produces RO water with a total energy requirement of 1,280 kWh/af. This includes 205 kWh/af for conveyance from Hyperion, 790 kWh/af for treatment with RO, and 285 kWh/af for distribution.

More than 210 South Bay sites use 9 billion gallons of West Basin's recycled water for applications including irrigation, industrial processes, indirect potable uses, and seawater barrier injection. West Basin has been successful in changing the perception of recycled water from merely a conservation tool with minimal applications to a cost-effective business tool that can reduce costs and improve reliability.

Local oil refineries are major customers for West Basin's recycled water. The Chevron Refinery in El Segundo, the Exxon-Mobile refinery in Torrance, and the BP refinery in Carson use recycled water for cooling towers and in the boiler feed systems.

## **Ocean Water Desalination Development**

Desalination technologies are in use around the world. A number of approaches work well and produce high quality water. Many workable and proven technology options are available to remove salt from water. During World War Two, desalination technology was developed as a water source for military operations.<sup>34</sup> Grand plans for nuclear-driven desalination systems in California were drawn up after the war, but they were never implemented due to cost and feasibility problems.

Desalination techniques range from distillation to “reverse osmosis” (RO) technologies. Current applications around the world are dominated by the “multistage flash distillation” process (at about 44% of the world’s applications), and RO, (at about 42%).<sup>35</sup> Other desalting technologies include electrodialysis (6%), vapor compression (4%), multi-effect distillation (4%), and membrane softening (2%) to remove salts.<sup>36</sup> All of the ocean desalination projects currently in place or proposed for municipal water supply in California employ RO technology.

### Reverse Osmosis Membranes



A recent inventory of desalination facilities world-wide indicated that as of the beginning of 1998, a total of 12,451 desalting units with a total capacity of 6.72 afy<sup>37</sup> had been installed or contracted worldwide.<sup>38</sup> (Note that *capacity* does not indicate actual operation.) Non-seawater desalination plants have a capacity 7,620 af/d<sup>39</sup>, whereas the seawater desalination plant capacity reached 10,781 af/d.<sup>40</sup>

Desalination systems are being used in over 100 countries, but 10 countries are responsible for 75 percent of the capacity.<sup>41</sup> Almost half of the desalting capacity is used to desalt seawater in the Middle East and North Africa. Saudi Arabia ranks first in total capacity (about 24 percent of the world’s capacity) followed by the United Arab Emirates and Kuwait, with most of the capacity being made up of seawater desalting units that use the distillation process.<sup>42</sup>

The salinity of ocean water varies, with the average generally exceeding 30 grams per liter (g/l).<sup>43</sup> The Pacific Ocean is 34-38 g/l, the Atlantic Ocean averages about 35 g/l, and the Persian Gulf is 45 g/l. Brackish water drops to 0.5 to 3.0 g/l.<sup>44</sup> Potable water salt levels should be below 0.5 g/l.



Reducing salt levels from over 30 g/l to 0.5 g/l and lower (drinking water standards) using existing technologies requires considerable amounts of energy, either for thermal processes or for the pressure to drive water through extremely fine filters such as RO, or for some combination of thermal and pressure processes. Recent improvements in energy efficiency have reduced the amount of thermal and pumping energy required for the various processes, but high energy intensity is still an issue. The energy required is in part a function of the degree of salinity and the temperature of the water.

West Basin is in the process of developing plans to construct an ocean desalinating plant. Estimated energy requirements have been calculated by Gerry Filteau of Separation Processes, Inc for each step in the process.<sup>45</sup> The values presented for desalination are based on his work. Since the proposed plant will tap the source water at the power plant, there is no ocean intake pumping required. The source water is estimated to require 200 kWh/af this energy will bring ocean water from the power plant to the desalination system, approximately one quarter of a mile in distance. Pre-treatment of the source water is estimated at 341 kWh/af. This figure includes microfiltration and transfer to the RO units via a 5-10 micron cartridge filter. The RO process requires 2,686 kWh/af if operated at the most energy-efficient level. A slightly less efficient but more cost-effective level of operation would require 2,900 kWh/af, or 214 kWh/af additional energy input according to Filteau. Finally, an estimated 460 kWh/af is required to deliver the product water to the distribution system, including elevation gain, conveyance over distance, and pressurization to 90 psi. No additional energy is required to discharge the brine, as it flows back to the ocean outfall line by gravity.

The energy intensity figures presented here for desalination are lower than previous estimates. This is mainly due to improved membrane technologies, efficiency improvements for high pressure pumps, and pressure recovery systems. It should be noted that the figures provided here are based on engineering estimates, not on actual plant operations.

The total energy required to desalinate the ocean water, including each of the steps above, is estimated to be 3,687 kWh/af. If the energy intensity is increased slightly to improve cost-effectiveness, the total figure increases to 3,901 kWh/af.

## Summary

This study examined the energy intensity of imported and local water supplies (ocean water, groundwater, and recycled water) for both potable and non-potable uses for West Basin. All water sources require pumping, treatment, and distribution. Differences in energy requirements arise from varying pumping, treatment, and distribution processes needed to produce water to meet appropriate standards for different uses.

The key findings of this study are: 1) the marginal energy required to treat and deliver recycled water is among the *least* energy intensive supply options available, 2) naturally recharged groundwater is low in energy intensity, though replenishment with imported water is not, and 3) current ocean desalination technology is getting close to the level of energy intensity of imported supplies.

Further refinement of the data in this study, such as applying an agency's own energy values, may provide a more accurate basis for decision-making tailored to a unique water system. The information presented, however, provides a reasonable basis for water managers to explore energy (and cost) benefits of increased use of local water sources, and it indicates that desalination of ocean water is getting close to the energy intensity of existing supplies.

## Sources

<sup>1</sup> Water systems account for roughly 7% of California's electricity use: See Wilkinson, Robert C., 2000. *Methodology For Analysis of The Energy Intensity of California's Water Systems, and an Assessment of Multiple Potential Benefits Through Integrated Water-Energy Efficiency Measures*, Exploratory Research Project, Ernest Orlando Lawrence Berkeley Laboratory, California Institute for Energy Efficiency.

<sup>2</sup> California Energy Commission, 2005. *Integrated Energy Policy Report*, November 2005, CEC-100-2005-007-CMF.

<sup>3</sup> Franklin Burton, in a recent study for the Electric Power Research Institute (EPRI), includes the following elements in water systems: "Water systems involve the transportation of water from its source(s) of treatment plants, storage facilities, and the customer. Currently, most of the electricity used is for pumping; comparatively little is used in treatment. For most surface sources, treatment is required consisting usually of chemical addition, coagulation and settling, followed by filtration and disinfection. In the case of groundwater (well) systems, the treatment may consist only of disinfection with chlorine. In the future, however, implementation of new drinking water regulations will increase the use of higher energy consuming processes, such as ozone and membrane filtration." Burton, Franklin L., 1996, *Water and Wastewater Industries: Characteristics and Energy Management Opportunities*. (Burton Engineering) Los Altos, CA, Report CR-106941, Electric Power Research Institute Report, p.3-1.

<sup>4</sup> Wilkinson, Robert C., 2000. *Methodology For Analysis of The Energy Intensity of California's Water Systems, and an Assessment of Multiple Potential Benefits Through Integrated Water-Energy Efficiency Measures*, Exploratory Research Project, Ernest Orlando Lawrence Berkeley Laboratory, California Institute for Energy Efficiency.

<sup>5</sup> California Public Utilities Commission, Order Instituting Rulemaking Regarding to Examine the Commission's post-2005 Energy Efficiency Policies, Programs, Evaluation, Measurement and Verification, and Related Issues, Rulemaking 06-04-010 (Filed April 13, 2006)

<sup>6</sup> An AF of water is the volume of water that would cover one acre to a depth of one foot. An AF equals 325,851 gallons, or 43,560 cubic feet, or 1233.65 cubic meters.

<sup>7</sup> Metropolitan Water District of Southern California, *Integrated Resource Plan for Metropolitan's Colorado River Aqueduct Power Operations*, 1996, p.5.

<sup>8</sup> This schematic, based on the original analysis by Wilkinson (2000) has been refined and improved with input from Gary Wolff, Gary Klein, William Kost, and others. It is the basic approach reflected in the CEC IEPR and other analyses.

<sup>9</sup> QEI, Inc., 1992, *Electricity Efficiency Through Water Efficiency*, Report for the Southern California Edison Company, p. 24.

<sup>10</sup> Figures cited are *net* energy requirements (gross energy for pumping minus energy recovered through generation).

<sup>11</sup> Metropolitan Water District of Southern California, *Integrated Resource Plan for Metropolitan's Colorado River Aqueduct Power Operations*, 1996, p.5.

<sup>12</sup> Wilkinson, Robert C., 2000. *Methodology For Analysis of The Energy Intensity of California's Water Systems, and an Assessment of Multiple Potential Benefits Through Integrated Water-Energy Efficiency Measures*, Exploratory Research Project, Ernest Orlando Lawrence Berkeley Laboratory, California Institute for Energy Efficiency.

<sup>13</sup> California Department of Finance. California Statistical Abstract. Tables G-2, "Gross Capacities of Reservoirs by Hydrographic Region," and G-3 "Major Dams and Reservoirs of California." January 2001. ([http://www.dof.ca.gov/html/fs\\_data/stat-abs/toc.htm](http://www.dof.ca.gov/html/fs_data/stat-abs/toc.htm))

---

<sup>14</sup> “The SWP, managed by the Department of Water Resources, is the largest state-built, multi-purpose water project in the country. Approximately 19 million of California’s 32 million residents receive at least part of their water from the SWP. SWP water irrigates approximately 600,000 acres of farmland. The SWP was designed and built to deliver water, control floods, generate power, provide recreational opportunities, and enhance habitats for fish and wildlife.” California Department of Water Resources, *Management of the California State Water Project*. Bulletin 132-96. p.xix.

<sup>15</sup> California Department of Water Resources, 1996, *Management of the California State Water Project*. Bulletin 132-96.p.xix.

<sup>16</sup> Three small reservoirs upstream of Lake Oroville — Lake Davis, Frenchman Lake, and Antelope Lake — are also SWP facilities. California Department of Water Resources, 1996, *Management of the California State Water Project*. Bulletin 132-96.

<sup>17</sup> California Department of Water Resources, 1996, *Management of the California State Water Project*. Bulletin 132-96. Power is generated at the Oroville Dam as water is released down the Feather River, which flows into the Sacramento River, through the Sacramento-San Joaquin Delta, and to the ocean through the San Francisco Bay.

<sup>18</sup> The North Bay Aqueduct was completed in 1988. (California Department of Water Resources, 1996, *Management of the California State Water Project*. Bulletin 132-96.)

<sup>19</sup> The South Bay Aqueduct provided initial deliveries for Alameda and Santa Clara counties in 1962 and has been fully operational since 1965. (California Department of Water Resources, 1996, *Management of the California State Water Project*. Bulletin 132-96.)

<sup>20</sup> Carrie Anderson, 1999, “Energy Use in the Supply, Use and Disposal of Water in California”, Process Energy Group, Energy Efficiency Division, California Energy Commission, p.1.

<sup>21</sup> Average deliveries for 1980-89 were just under 2.0 mafy, deliveries for 1990-99 were just over 2.0 mafy. There is disagreement regarding the ability of the SWP to deliver the roughly 4.2 mafy that has been contracted for.

<sup>22</sup> According to MWD, “Metropolitan’s annual dependable supply from the Colorado River is approximately 656,000 AF -- about 550,000 AF of entitlement and at least 106,000 AF obtained through a conservation program Metropolitan funds in the Imperial Irrigation District in the southeast corner of the state. However, Metropolitan has been allowed to take up to 1.3 maf of river water a year by diverting either surplus water or the unused portions of other agencies’ apportionments.” Metropolitan Water District of Southern California, 1999, “Fact Sheet” at: <http://www.mwd.dst.ca.us/docs/fctsheets.htm>.

<sup>23</sup> Metropolitan Water District of Southern California, 1999, <http://www.mwd.dst.ca.us/pr/powres/summ.htm>.

<sup>24</sup> The five pumping plants each have nine pumps. The plants are designed for a maximum flow of 225 cubic feet per second (cfs). The CRA is designed to operate at full capacity with eight pumps in operation at each plant (1800 cfs). The ninth pump operates as a spare to facilitating maintenance, emergency operations, and repairs. Metropolitan Water District of Southern California, 1999, Colorado River Aqueduct: <http://aqueduct.mwd.dst.ca.us/areas/desert.htm>, 08/01/99.

<sup>25</sup> Metropolitan Water District of Southern California, 1996, “Integrated Resource Plan for Metropolitan’s Colorado River Aqueduct Power Operations”, 1996, p.5.

<sup>26</sup> Metropolitan Water District of Southern California, 1999, “Summary of Metropolitan’s Power Operation”. February, 1999, p.1, <http://aqueduct.mwd.dst.ca.us/areas/desert.htm>.

<sup>27</sup> Metropolitan Water District of Southern California, 1999, <http://www.mwd.dst.ca.us/pr/powres/summ.htm>. MWD provides further important system information as follows: Metropolitan owns and operates 305 miles of 230 kV transmission lines from the Mead Substation in southern Nevada. The transmission system is used to deliver power from Hoover and Parker to the CRA pumps. Additionally, Mead is the primary interconnection point for Metropolitan’s economy energy purchases. Metropolitan’s transmission system is interconnected with several utilities at multiple